

# INDEX

100 SERIES – Accessories . . . . . (100) 1 - 16

388/600 SERIES – RTA & Assembled Components with 1" or 1½" Tops . (388/600) 1 - 110

LEVELS – RTA & Assembled Components featuring Metal Supports & Legs . . . . .(LEV) 1 - 122

RECEPTION – Reception Concepts including 388 Gallery. . . . . (REC) 1 - 42

850 SERIES – RTA & Assembled Modular Metal Leg Series . . . . . (850) 1 - 24

WORKSCAPE – RTA & Assembled Made-to-Fit Modern Components . . . . . (WRK) 1 - 48

OUTLINES / OUTLINES *Plus*– Divider Panel System. . . . . (OUT) 1 - 57

PROTECTIVE HEALTH GUARD - Divider Systems . . . . . (PHG) 58 - 66

FRAMEWORK – Panel Suspended Furniture Components . . . . . (FRM) 1 - 30

FLEX – Versatile Training Table Tops and Bases. . . . . (FLX) 1 - 22

900 SERIES – Table Tops, Bases and Conference Furniture . . . . . (900) 1 - 28

JUPITER – Seating . . . . . (JUP) 1 - 12

HEIGHT ADJUSTABLE – Height Adjustable Desking . . . . . (HT-ADJ) 1 - 32

TEAM – Power Walls, TEAMing Stations, Powerline & Carrels . . . . . (TEM) 1 - 20

TERMS, CONDITIONS, WARRANTY & FREIGHT CLAIMS . . . . . I - II

**QUICK TIPS FOR INTERACTIVE CATALOGUE:**

- CLICK ON **BLUE** TEXT TO GO DIRECTLY TO THAT SERIES SECTION OR PAGE
- SELECT INDEX OR SERIES INDEX BUTTONS (BOTTOM RIGHT HAND CORNER) TO RETURN DIRECTLY TO INDICATED LOCATION
- WHEN IN PDF VIEWING "FULL SCREEN MODE":
  - LEFT CLICK - WILL ADVANCE TO NEXT PAGE
  - RIGHT CLICK - WILL GO BACK TO PREVIOUS PAGE
  - ESC - TO EXIT PRESENTATION MODE
  - HOME - FIRST PAGE
  - END - LAST PAGE



## THIS IS A METRIC SERIES

HML products are manufactured using metric dimensions, therefore the size indicated within a unit name, being in inches, will not accurately reflect the exact size of the unit. Any Imperial dimensions that have been used in this book have been converted from the actual metric size and rounded up to the next 1/4". This means that all units will be slightly smaller in width & length than indicated by their model name. For example, an 388-2430RS is indicated as 23.75" x 29.5" in the price book dimension columns and actually measures 23.62" x 29.53".



Imperial dimensions (exact size) are available upon request – a 5% upcharge will apply. To order imperial dimension units, add 'i' in front of the SKU. Order Example: i388-3660CM-B









# 100 SERIES - ACCESSORIES

This is a metric series. Please refer to page [INDEX](#) for details

|                                     |                        |
|-------------------------------------|------------------------|
| <b>Product by Category</b> .....    |                        |
| Handles.....                        | <a href="#">100-3</a>  |
| Keyboard Trays.....                 | <a href="#">100-4</a>  |
| Grommets & Power/Data Grommets..... | <a href="#">100-6</a>  |
| Monitor Supports.....               | <a href="#">100-9</a>  |
| CPU Holders.....                    | <a href="#">100-10</a> |
| Wire Management.....                | <a href="#">100-11</a> |
| Brackets.....                       | <a href="#">100-12</a> |
| Task Lights.....                    | <a href="#">100-12</a> |
| Storage.....                        | <a href="#">100-13</a> |
| Height Adjustable.....              | <a href="#">100-14</a> |



|   | MODEL   | LIST   | FINISH  |                                    |
|---|---|--|---|------------------------------------|
| <b>INSTALLED</b>  |   |  |   |                                    |
| Doors and Drawers will be drilled & handles will be supplied or installed.  |   |  |   |                                    |
| <br><b>Step</b><br>2 Sizes<br>Champagne      | 100-STEP-INST   | \$33   | CHAMPAGNE (CP)  |                                    |
|   | 100-BAR6-INST   | \$33   | BLACK (BL) OR ALUMINIUM (AL)  |                                    |
|   | 100-BRIDGE-INST   | \$33   | ALUMINIUM (AL)  |                                    |
|   | 100-FLUTED-INST   | \$33   | BLACK (BL) OR CHAMPAGNE (CP)  |                                    |
|   | 100-ARCHED-INST   | \$33   | BLACK (BL)  |                                    |
|   | 100-DBLARCHED-INST  | \$33   | BLACK (BL) OR NICKEL (NL)   |                                    |
|   | 100-SSCOOP-INST   | \$33   | BLACK (BL) OR ALUMINIUM (AL)  |                                    |
|   | 100-LSCOOP-INST   | \$33   | BLACK (BL) OR ALUMINIUM (AL)  |                                    |
|   | <br><b>Bar6</b><br>3 Sizes<br>Silver | 100-STEP   | \$23  | CHAMPAGNE (CP)                     |
|   |   | 100-BAR6   | \$24  | BLACK (BL) & ALUMINIUM/SILVER (AL) |
| 100-BRIDGE  |   | \$23   | ALUMINIUM (AL)  |                                    |
| 100-FLUTED  |   | \$23   | BLACK (BL) OR CHAMPAGNE (CP)  |                                    |
| 100-ARCHED  |   | \$23   | BLACK (BL)  |                                    |
| 100-DBLARCHED   |   | \$23   | BLACK (BL) OR NICKEL (NL)   |                                    |
| 100-SMALLSCOOP  |   | \$23   | AVAILABLE FINISH: BLACK (BL) & ALUMINIUM/SILVER (AL)  |                                    |
| 100-LARGESCOOP  |   | \$23   | AVAILABLE FINISH: BLACK (BL) OR ALUMINIUM/SILVER (AL)   |                                    |
| <b>HANDLE DEFAULTS AND ORDERING INFORMATION:</b>  |   |  |   |                                    |
| <br><b>Arched</b><br>Black                   |   | <b>388 Series</b>  | <ul style="list-style-type: none"> <li>♥ Black scoop are the default handles for all finishes except Evening Zen (EZ) &amp; Grey Dusk (GD).</li> <li>♥ Aluminium scoop is the default handle for Evening Zen (EZ) finish and Grey Dusk (GD).</li> <li>♥ Aluminium bar is the default handle for Winter Wood (WW).</li> <li>♥ All units with doors and drawers include handles except hutches and overhead storage.</li> </ul> |                                    |
|   | <b>Levels Series</b>  | <ul style="list-style-type: none"> <li>♥ Black bar handles are the default except for select finishes which have aluminium bar. See the Levels Series "Finishes" chart for more details</li> <li>♥ All units with doors and drawers include handles except hutches and overhead storage.</li> </ul>  |   |                                    |
| <br><b>Double Arched</b><br>Black/ Nickel   | <b>600 series</b>   | ♥ All units with doors and drawers include handles except hutches and overhead storage. Please make selection from the list of available handles.  |   |                                    |
|   | <b>850 Series</b>   | ♥ All units with doors and drawers include handles except hutches and overhead storage. Please make selection from the list of available handles.  |   |                                    |
| <br><b>SmallScoop</b><br>Black/ Aluminium  | <b>Outlines Series</b>  |  |   |                                    |
|   | <b>AGD Doors</b>  | <ul style="list-style-type: none"> <li>♥ Silver finish bar handles are the default handle for Aluminium Frame Plexiglass Doors (AGD). For other handle choices, please indicate on your order.</li> <li>♥ Hutches and overhead storage do not include handles. Please indicate your handle choice and the finish on your purchase order if they are required.</li> </ul> |   |                                    |
| <br><b>Large Scoop</b><br>Black/ Aluminium |   |  |   |                                    |

| MODEL | LIST | WEIGHT | CUBE            | W  | D  | H  |
|-------|------|--------|-----------------|----|----|----|
|       |      | LBS    | FT <sup>3</sup> | IN | IN | IN |

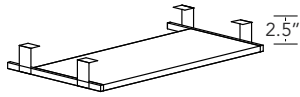

SIT TO STAND  
COMPATIBLE

**KEYBOARD DRAWER**

- EXTRA WIDTH FOR MOUSE

|                 |              |           |          |           |              |             |
|-----------------|--------------|-----------|----------|-----------|--------------|-------------|
| <b>100-KD28</b> | <b>\$202</b> | <b>10</b> | <b>1</b> | <b>28</b> | <b>11.25</b> | <b>3.25</b> |
|-----------------|--------------|-----------|----------|-----------|--------------|-------------|

AVAILABLE FINISHES: ALL STANDARD HEARTWOOD LAMINATE FINISHES

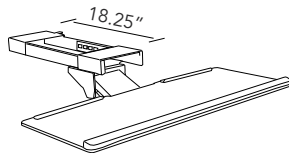

**ARTICULATING KEYBOARD TRAY**

TRACK MOUNT HIDE-AWAY DESIGN - 12.75" SLIDE

|                |              |                  |                   |             |           |             |
|----------------|--------------|------------------|-------------------|-------------|-----------|-------------|
| <b>100-KB2</b> | <b>\$305</b> | <b>13.8/6.26</b> | <b>1.024/.029</b> | <b>26.5</b> | <b>10</b> | <b>6.75</b> |
|----------------|--------------|------------------|-------------------|-------------|-----------|-------------|

- HEIGHT ADJUSTMENT (6.75")
- SWIVEL RANGE: -20° TO 20°
- HEAVY-DUTY STEEL CONSTRUCTION PROVIDES EXTRA STRENGTH & DURABILITY
- NOT COMPATIBLE WITH SIT-TO-STAND

AVAILABLE FINISH BLACK (BL)

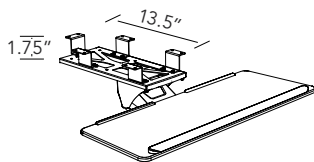

SIT TO STAND  
COMPATIBLE

**ARTICULATING KEYBOARD TRAY**

- LARGE TRAY - 26"W X 9.7"D. HOLDS UP TO 2.2LBS. HEIGHT ADJ. - 4 1/4" & TILTING ADJ. - 16° / +20°. VINYL WRAPPED MDF CONSTRUCTION WITH WRIST REST. REQUIRES 13 1/2" OF DEPTH CLEARANCE UNDER THE WORK SURFACE.

|                   |              |             |             |              |             |               |
|-------------------|--------------|-------------|-------------|--------------|-------------|---------------|
| <b>100-AKTM-2</b> | <b>\$275</b> | <b>12.8</b> | <b>1.14</b> | <b>26.25</b> | <b>9.75</b> | <b>0-4.25</b> |
|-------------------|--------------|-------------|-------------|--------------|-------------|---------------|

AVAILABLE FINISH: BLACK (BL)

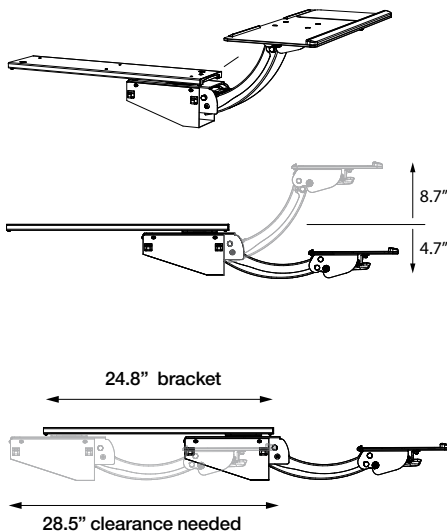

**SPRING ASSISTED ADJUSTABLE KEYBOARD TRAY**

EASILY TRANSITION FROM SIT TO STAND

|                  |              |              |           |             |            |                 |
|------------------|--------------|--------------|-----------|-------------|------------|-----------------|
| <b>100-COBRA</b> | <b>\$494</b> | <b>20.95</b> | <b>.4</b> | <b>26.4</b> | <b>8.5</b> | <b>4.7-13.4</b> |
|------------------|--------------|--------------|-----------|-------------|------------|-----------------|

- EASY TO USE LEVER HANDLE ADJUSTMENT
- ERGONOMIC DESIGN INCLUDING WRIST REST
- WEIGHT CAPACITY: 2KG / 4.4 LBS
- TRAY TILT FUNCTION 13° TO 15°
- SWIVEL RANGE -180° TO 180°
- ARM DEPTH CLEARANCE: 28.5" IS NEEDED TO PUSH ARM ALL THE WAY UNDER THE DESK
- 30" WORK SURFACES WITH MODESTY PANELS MUST HAVE A FLUSH MODESTY PANEL INSTALL

AVAILABLE FINISHES: BLACK (BL)

**NOTE:** THE **100-COBRA-BL** IS **NOT** COMPATIBLE WITH HEIGHT ADJUSTABLE DESKING. FOR USE WITH LAMINATE DESKING/TABLES 30" DEEP OR GREATER.

| MODEL | LIST | WEIGHT | CUBE            | W  | D  | H  |
|-------|------|--------|-----------------|----|----|----|
|       |      | LBS    | FT <sup>3</sup> | IN | IN | IN |

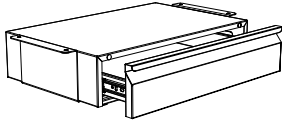
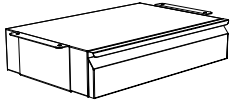

SIT TO STAND  
COMPATIBLE

**METAL STORAGE DRAWER**

UNDERMOUNT, SPACE-SAVING STORAGE DRAWER IDEAL FOR SIT-TO-STAND APPLICATIONS

|                   |              |      |    |      |           |     |
|-------------------|--------------|------|----|------|-----------|-----|
| <b>100-DRAWER</b> | <b>\$232</b> | 11.5 | .3 | 20.2 | 12.2-18.9 | 4.3 |
|-------------------|--------------|------|----|------|-----------|-----|

- SOLID STEEL CONSTRUCTION W/ SLIM, FLUSH MOUNT DESIGN
- SMOOTH GLIDE DRAWER MECHANISM - DRAWER TRACK TRAVEL 170MM (6.7")
- WEIGHT CAPACITY: 5KG / 11 LBS
- COMPATIBLE WITH CALYPSO HEIGHT ADJUSTABLE DESKING ON TOPS 30" DEEP OR GREATER

AVAILABLE FINISHES: BLACK (BL)

**PENCIL DRAWER**

LAMINATE DRAWER FRONT W/ MATCHING 2MM EDGE BAND

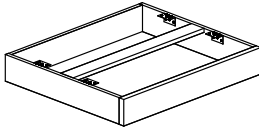

|                   |              |    |     |    |    |      |
|-------------------|--------------|----|-----|----|----|------|
| <b>100-2219PD</b> | <b>\$266</b> | 12 | 1.5 | 22 | 19 | 3.25 |
| <b>100-2919PD</b> | <b>\$275</b> | 15 | 2   | 29 | 19 | 3.25 |

- NOT-COMPATIBLE WITH SIT-TO-STAND

AVAILABLE FINISHES: ALL STANDARD HEARTWOOD LAMINATE FINISHES

**2" X 3" RECTANGLE GROMMET**

FACTORY INSTALLED

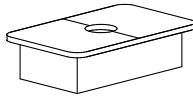

|               |             |     |       |      |      |   |
|---------------|-------------|-----|-------|------|------|---|
| <b>100-GR</b> | <b>\$46</b> | 0.1 | 0.004 | 3.25 | 2.25 | 1 |
|---------------|-------------|-----|-------|------|------|---|

AVAILABLE IN BULK

|                |             |     |       |      |      |   |
|----------------|-------------|-----|-------|------|------|---|
| <b>100-G19</b> | <b>\$22</b> | 0.1 | 0.004 | 3.25 | 2.25 | 1 |
|----------------|-------------|-----|-------|------|------|---|

AVAILABLE FINISHES: BLACK (BL) & GREY (GR)

**3" ROUND GROMMET**



|                |             |    |       |      |      |   |
|----------------|-------------|----|-------|------|------|---|
| <b>100-GR3</b> | <b>\$31</b> | .1 | .0039 | 3.75 | 3.75 | 1 |
|----------------|-------------|----|-------|------|------|---|

AVAILABLE FINISHES: BLACK (BL)

| MODEL | LIST | WEIGHT | CUBE            | W  | D  | H  |
|-------|------|--------|-----------------|----|----|----|
|       |      | LBS    | FT <sup>3</sup> | IN | IN | IN |

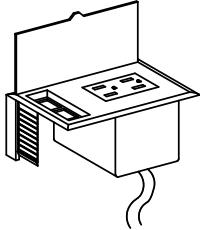

**POWER GROMMET**

FOR CONFERENCE OR WORK SURFACE TOPS. INCLUDES 2 POWER OUTLETS & 6 FT. POWER CORD, 2 OPENINGS FOR ETHERNET OR PHONE COUPLERS (SEE BELOW), DROP DOWN CORD COVER AND COST OF WORKSURFACE CUT OUT FOR INSERTION

|                    |              |          |            |            |            |             |
|--------------------|--------------|----------|------------|------------|------------|-------------|
| <b>100-PWRGROM</b> | <b>\$481</b> | <b>2</b> | <b>0.5</b> | <b>6.5</b> | <b>3.5</b> | <b>2.75</b> |
|--------------------|--------------|----------|------------|------------|------------|-------------|

**NOTE:**

- A DETAILED DRAWING WITH THE EXACT GROMMET LOCATION MUST BE PROVIDED.
- IF A CUSTOM POWER GROMMET IS REQUIRED- IE. HDMI ETC... SEE 100-RECP-XX OR CONTACT CUSTOMER SERVICE FOR A QUOTE.

AVAILABLE FINISHES: BLACK (BL)

**COUPLERS**

ETHERNET (RJ45) COUPLER FOR 100-PWRGROM

|                   |             |
|-------------------|-------------|
| <b>100-DATACP</b> | <b>\$82</b> |
|-------------------|-------------|

PHONE (RJ11) COUPLER FOR 100-PWRGROM

|                    |              |
|--------------------|--------------|
| <b>100-PHONECP</b> | <b>\$108</b> |
|--------------------|--------------|

UL CERTIFIED

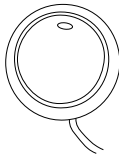
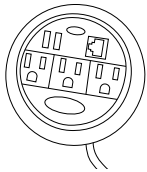
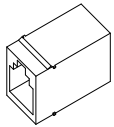

**FLIP POSITION**

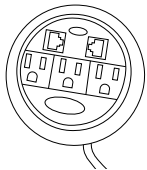

**FLUSH FLIP TOP POWER GROMMET**

|                    |              |          |             |            |            |          |
|--------------------|--------------|----------|-------------|------------|------------|----------|
| <b>100-FTP-USB</b> | <b>\$451</b> | <b>2</b> | <b>0.14</b> | <b>4.3</b> | <b>4.3</b> | <b>2</b> |
|--------------------|--------------|----------|-------------|------------|------------|----------|

- 3 POWER, 1 ETHERNET CAT5E (RJ45) PORT AND 2 USB PORTS. USB PORTS CAN BE USED AS DATA TRANSFER OR CHARGING @ 2.1AMPS

|                     |              |          |             |            |            |          |
|---------------------|--------------|----------|-------------|------------|------------|----------|
| <b>100-FTP-DATA</b> | <b>\$318</b> | <b>2</b> | <b>0.14</b> | <b>4.3</b> | <b>4.3</b> | <b>2</b> |
|---------------------|--------------|----------|-------------|------------|------------|----------|

- 3 POWER, 2 ETHERNET CAT5E (RJ45) PORTS
- STREAMLINE PROFILE WITH HIDDEN RECEPTACLES WHEN IN FLIPPED POSITION
- 10' POWER CORD, UL CERTIFIED.
- LIST PRICE INCLUDES CUSTOM CUTOUT FOR GROMMET INSTALL.

AVAILABLE FINISHES: BLACK (BL)



| MODEL | LIST | WEIGHT | CUBE            | W  | D  | H  |
|-------|------|--------|-----------------|----|----|----|
|       |      | LBS    | FT <sup>3</sup> | IN | IN | IN |

**POWER GROMMET**



|                    |              |             |            |             |          |             |
|--------------------|--------------|-------------|------------|-------------|----------|-------------|
| <b>100-RECP-01</b> | <b>\$650</b> | <b>2.09</b> | <b>2.8</b> | <b>8.75</b> | <b>5</b> | <b>4.25</b> |
|--------------------|--------------|-------------|------------|-------------|----------|-------------|

- 2 POWER
- 4 USB PORTS. 2 CHARGING ONLY PORTS @ 2.1AMPS AND 2 DATA TRANSFER PORTS
- 1 USB 2.0 PORT
- 1 ETHERNET CAT6 (RJ45) PORT
- 1 PHONE (RJ11) PORT
- UL CERTIFIED
- LIST PRICE INCLUDES CUSTOM CUTOUT FOR GROMMET INSTALL.
- 10' POWER CORD

**AVAILABLE FINISH:** BLACK (BL)

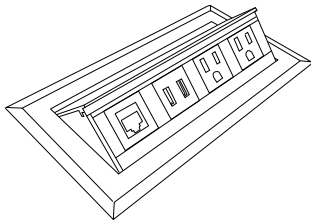

|                    |              |            |            |             |             |             |
|--------------------|--------------|------------|------------|-------------|-------------|-------------|
| <b>100-RECP-02</b> | <b>\$888</b> | <b>2.9</b> | <b>2.8</b> | <b>8.25</b> | <b>4.25</b> | <b>2.25</b> |
|--------------------|--------------|------------|------------|-------------|-------------|-------------|

- 2 POWER
- 2 USB CHARGING ONLY PORTS @ 2.1AMPS
- 1 ETHERNET CAT6 (RJ45) PORT
- 10' POWER CORD, UL CERTIFIED
- LIST PRICE INCLUDES CUSTOM CUTOUT FOR GROMMET INSTALL.

**AVAILABLE FINISH:** ALUMINIUM HOUSING (PREMIUM FINISH)

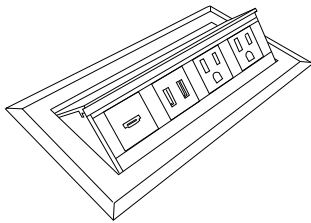

|                    |              |            |            |             |             |             |
|--------------------|--------------|------------|------------|-------------|-------------|-------------|
| <b>100-RECP-03</b> | <b>\$888</b> | <b>2.9</b> | <b>2.8</b> | <b>8.25</b> | <b>4.25</b> | <b>2.25</b> |
|--------------------|--------------|------------|------------|-------------|-------------|-------------|

- 2 POWER
- 2 USB CHARGING ONLY PORTS @ 2.1AMPS
- 1 HDMI PORT
- 10' POWER CORD, UL CERTIFIED
- LIST PRICE INCLUDES CUSTOM CUTOUT FOR GROMMET INSTALL.

**AVAILABLE FINISH:** ALUMINIUM HOUSING (PREMIUM FINISH)

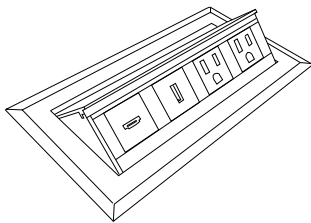

|                    |              |            |            |             |             |             |
|--------------------|--------------|------------|------------|-------------|-------------|-------------|
| <b>100-RECP-04</b> | <b>\$888</b> | <b>2.9</b> | <b>2.8</b> | <b>8.25</b> | <b>4.25</b> | <b>2.25</b> |
|--------------------|--------------|------------|------------|-------------|-------------|-------------|

- 2 POWER
- 1 - DATA PORT: ETHERNET CAT6 (RJ45) PORT
- 1 HDMI PORT
- 10' POWER CORD, UL CERTIFIED
- LIST PRICE INCLUDES CUSTOM CUTOUT FOR GROMMET INSTALL.

**AVAILABLE FINISH:** ALUMINIUM HOUSING (PREMIUM FINISH)

**100-RECP-CUSTOM**

**100-RECP-CUSTOM** CAN BE CUSTOMIZED TO SUIT SPECIFIC CONFIGURATION NEEDS. PLEASE CONTACT CUSTOMER SERVICE FOR MORE INFORMATION AND PRICING.

- CUSTOM POWER GROMMETS EXTENDED LEAD TIMES. APPLY APPROX 4-6 WEEK LEAD TIME.

SOME OF THE CUSTOMIZATION OPTIONS AVAILABLE ARE AS FOLLOWS:

ADAPTER OPTIONS:

- POWER RECEPTACLES
- 2 USB CHARGING ONLY PORTS @ 2.1AMPS
- ETHERNET (RJ45) PORT
- PHONE (RJ11) PORT
- HDMI PORT
- VGA PORT
- OPTION TO INCLUDE A SURGE PROTECTOR

FINISH OPTIONS:

- ANODIZED ALUMINUM
- BLACK
- WHITE
- BRONZE

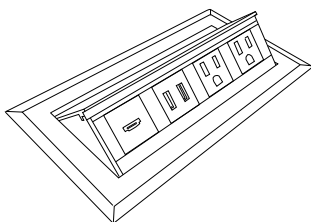

| MODEL | LIST | WEIGHT | CUBE            | W  | D  | H  |
|-------|------|--------|-----------------|----|----|----|
|       |      | LBS    | FT <sup>3</sup> | IN | IN | IN |

**POWER GROMMET WITH USB**

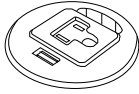

|                    |              |            |            |             |             |          |
|--------------------|--------------|------------|------------|-------------|-------------|----------|
| <b>100-GRP-USB</b> | <b>\$197</b> | <b>0.8</b> | <b>0.1</b> | <b>2.75</b> | <b>2.75</b> | <b>2</b> |
|--------------------|--------------|------------|------------|-------------|-------------|----------|

- 1 POWER
- 1 USB PORT. USB CHARGING @ 2.1AMPS OR DATA TRANSFER
- 5' POWER CORD, UL CERTIFIED
- 2.36"/60MM HOLE SIZE
- LIST PRICE INCLUDES CUSTOM CUTOUT FOR GROMMET INSTALL.

**AVAILABLE FINISH:** BLACK (BL)

**WIRELESS AND USB CHARGING DRAWER**

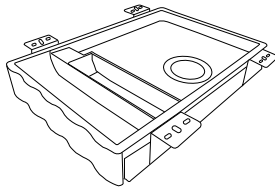

|                    |              |            |            |          |           |          |
|--------------------|--------------|------------|------------|----------|-----------|----------|
| <b>100-WCD-USB</b> | <b>\$367</b> | <b>4.8</b> | <b>0.2</b> | <b>9</b> | <b>13</b> | <b>2</b> |
|--------------------|--------------|------------|------------|----------|-----------|----------|

- STATIONARY PENCIL DRAWER WITH QI ENABLED WIRELESS CHARGING
- 2 USB CHARGING ONLY PORTS @ 2.1AMPS
- 5' GROUNDED POWER CORD, UL CERTIFIED

**AVAILABLE FINISH:** BLACK (BL)

**ANGLED DESKTOP POWER GROMMET**

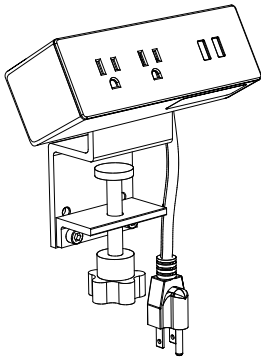

|                     |              |          |            |             |             |             |
|---------------------|--------------|----------|------------|-------------|-------------|-------------|
| <b>100-DTP2-USB</b> | <b>\$332</b> | <b>2</b> | <b>.16</b> | <b>6.25</b> | <b>3.75</b> | <b>3.75</b> |
|---------------------|--------------|----------|------------|-------------|-------------|-------------|

- USB CHARGER: 5V DC 3.1A (15.5 WATTS), 1.5A PER PORT (7.5 WATTS) RATING: 125V 60HZ 15A
- CHARGING ONLY. 10' 14 AWG X 3C POWER CORD.
- CUL CERTIFIED FOR USE IN CANADA. CAN CLAMP THROUGH OUR RECTANGLE GROMMET (CLAMP WIDTH: 60MM)
- 2 - US POWER, 2 - 3.1A USB CHARGING
- 6' POWER CORD

**AVAILABLE FINISHES:** BLACK (BL) & WHITE (WH)

**UNDERMOUNT POWER BAR WITH USB**

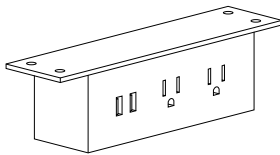

|                        |              |            |            |             |          |             |
|------------------------|--------------|------------|------------|-------------|----------|-------------|
| <b>100-UMNT-USB-AA</b> | <b>\$322</b> | <b>2.4</b> | <b>0.1</b> | <b>7.75</b> | <b>2</b> | <b>2.25</b> |
|------------------------|--------------|------------|------------|-------------|----------|-------------|

- USB CHARGER: 5V DC 3.1A (15.5 WATTS), 1.5A PER PORT (7.5 WATTS) RATING: 125V 60HZ 15A (1875 WATTS)
- 2 - US POWER, 2 - 3.1A USB CHARGING
- UL CERTIFIED
- 6' POWER CORD

**AVAILABLE FINISHES:** BLACK (BL)

**POWER BAR WITH USB**

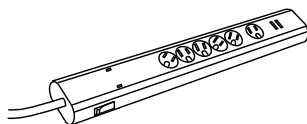

|                    |              |             |            |              |             |             |
|--------------------|--------------|-------------|------------|--------------|-------------|-------------|
| <b>100-PB6-USB</b> | <b>\$157</b> | <b>1.93</b> | <b>.07</b> | <b>15.75</b> | <b>2.25</b> | <b>1.25</b> |
|--------------------|--------------|-------------|------------|--------------|-------------|-------------|

- RATED FOR 15A @ 120V (1800 WATTS)
- USB CHARGER - 2- 2.1AMP PORTS - 5VDC - 2.1A PER PORT. USB CHARGING ONLY.
- 6 - AC 120V GROUND PLUGS
- 10' POWER CORD WITH 90° PLUG
- CUL CERTIFIED FOR USE IN CANADA

**AVAILABLE FINISH:** BLACK (BL)

| MODEL | LIST | WEIGHT | CUBE            | W  | D  | H  |
|-------|------|--------|-----------------|----|----|----|
|       |      | LBS    | FT <sup>3</sup> | IN | IN | IN |

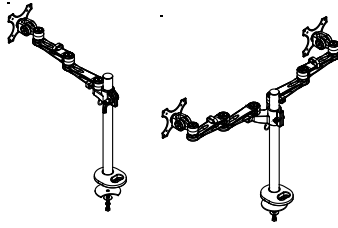

**LCD SINGLE MONITOR ARM**

|                 |              |          |            |           |          |           |
|-----------------|--------------|----------|------------|-----------|----------|-----------|
| <b>100-LCD1</b> | <b>\$370</b> | <b>8</b> | <b>0.4</b> | <b>14</b> | <b>8</b> | <b>18</b> |
|-----------------|--------------|----------|------------|-----------|----------|-----------|

- CAPACITY: 10KG / 22 LBS PER ARM. GROMMET MOUNT

**LCD DUAL MONITOR ARM**

|                 |              |           |            |           |          |           |
|-----------------|--------------|-----------|------------|-----------|----------|-----------|
| <b>100-LCD2</b> | <b>\$538</b> | <b>21</b> | <b>1.5</b> | <b>28</b> | <b>8</b> | <b>18</b> |
|-----------------|--------------|-----------|------------|-----------|----------|-----------|

- CAPACITY: 6KG / 13.2 LBS PER ARM. GROMMET MOUNT

AVAILABLE FINISH: SILVER (SL)

**FINGER TOUCH PNEUMATIC SINGLE MONITOR ARM**

|                 |              |            |           |             |             |              |
|-----------------|--------------|------------|-----------|-------------|-------------|--------------|
| <b>100-MA1B</b> | <b>\$405</b> | <b>8.4</b> | <b>.5</b> | <b>24.5</b> | <b>24.5</b> | <b>22.25</b> |
|-----------------|--------------|------------|-----------|-------------|-------------|--------------|

- PREMIUM FINGER TOUCH HEIGHT ADJUSTMENT
- VESA QUICK RELEASE CONNECTION
- 36.0" MAX. MONITOR, LANDSCAPE OR PORTRAIT ORIENTATION
- DESK CLAMP AND GROMMET MOUNT INCLUDED
- RECOMMENDED FOR DEEP WORKSURFACES OR CORNER APPLICATIONS (30+" DEEP)
- 14" HEIGHT ADJUSTMENT RANGE
- 5"-19.0" (LOW/HIGH), 24.0" ARM EXTENSION, 90° MONITOR TILT, 90° VESA ROTATION
- 6.6 LBS.-24.4 LBS. WEIGHT CAPACITY (PER ARM)
- EXCEEDS BIFMA X5.5 REQUIREMENT
- COMPATIBLE WITH OPTIONAL LAPTOP HOLDER **100-LPTP**

AVAILABLE FINISHES: BLACK (BL) & SILVER (SL)

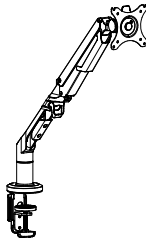

**FINGER TOUCH PNEUMATIC DUAL MONITOR ARM**

|                 |              |             |            |              |              |              |
|-----------------|--------------|-------------|------------|--------------|--------------|--------------|
| <b>100-MA2B</b> | <b>\$585</b> | <b>16.3</b> | <b>.69</b> | <b>49.75</b> | <b>23.75</b> | <b>22.25</b> |
|-----------------|--------------|-------------|------------|--------------|--------------|--------------|

- FINGER TOUCH HEIGHT ADJUSTMENT
- VESA QUICK RELEASE
- 32.0" MAX. MONITOR, LANDSCAPE, PORTRAIT OR COMBINATION OF BOTH
- DESK CLAMP AND GROMMET MOUNT INCLUDED
- RECOMMENDED FOR DEEP WORKSURFACES OR CORNER APPLICATIONS (30+" DEEP)
- 14" HEIGHT ADJUSTMENT RANGE
- 5"-19.0" (LOW/HIGH), 24.0" ARM EXTENSION, 90° MONITOR TILT, 90° VESA ROTATION
- 4.4 LBS.-19.8 LBS. WEIGHT CAPACITY (PER ARM)
- EXCEEDS BIFMA X5.5 REQUIREMENT
- COMPATIBLE WITH OPTIONAL LAPTOP HOLDER **100-LPTP**

AVAILABLE FINISHES: BLACK (BL) & SILVER (SL)

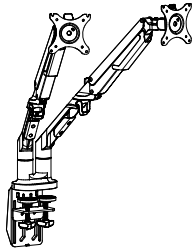

**PNEUMATIC LCD SINGLE MONITOR ARM**

|                |              |          |            |           |           |           |
|----------------|--------------|----------|------------|-----------|-----------|-----------|
| <b>100-MA1</b> | <b>\$306</b> | <b>8</b> | <b>0.5</b> | <b>16</b> | <b>16</b> | <b>18</b> |
|----------------|--------------|----------|------------|-----------|-----------|-----------|

- CAPACITY: 19.8 LBS PER ARM, CLAMP TO DESK OR GROMMET MOUNT
- HOLDS MONITOR SIZE 13" - 30", LANDSCAPE OR PORTRAIT ORIENTATION
- 90 DEGREE SWIVEL ANGLE, 180 DEGREE ROTATION IN BOTH DIRECTIONS, 15 DEGREE TILT ANGLE
- COMPATIBLE WITH OPTIONAL LAPTOP HOLDER **100-LPTP**

AVAILABLE FINISHES: BLACK (BL) & SILVER (SL)



**PNEUMATIC LCD DUAL MONITOR ARM**

|                |              |           |            |           |           |           |
|----------------|--------------|-----------|------------|-----------|-----------|-----------|
| <b>100-MA2</b> | <b>\$436</b> | <b>14</b> | <b>1.0</b> | <b>32</b> | <b>16</b> | <b>18</b> |
|----------------|--------------|-----------|------------|-----------|-----------|-----------|

- CAPACITY: 16 LBS PER ARM, CLAMP TO DESK OR GROMMET MOUNT
- HOLDS MONITOR SIZE 13" - 30", LANDSCAPE, PORTRAIT OR COMBINATION OF BOTH ORIENTATION
- 90 DEGREE SWIVEL ANGLE, 180 DEGREE ROTATION IN BOTH DIRECTIONS, 15 DEGREE TILT ANGLE
- COMPATIBLE WITH OPTIONAL LAPTOP HOLDER **100-LPTP**

AVAILABLE FINISHES: BLACK (BL) & SILVER (SL)



| MODEL | LIST | WEIGHT | CUBE            | W  | D  | H  |
|-------|------|--------|-----------------|----|----|----|
|       |      | LBS    | FT <sup>3</sup> | IN | IN | IN |

**NEW!**

**PNEUMATIC DUAL MONITOR ARM**

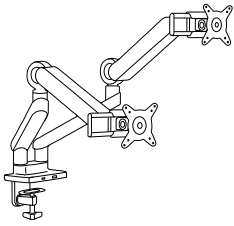

|                    |              |             |             |           |           |           |
|--------------------|--------------|-------------|-------------|-----------|-----------|-----------|
| <b>100-MA2C-BL</b> | <b>\$590</b> | <b>15.4</b> | <b>0.64</b> | <b>52</b> | <b>25</b> | <b>21</b> |
|--------------------|--------------|-------------|-------------|-----------|-----------|-----------|

- DETACHABLE VESA PLATE (DRILLED FOR 75X75 AND 100X100) FOR EASIER MONITOR INSTALLATION
- HOLDS MONITOR SIZE 17" - 32", LANDSCAPE, PORTRAIT OR COMBINATION OF BOTH ORIENTATION
- 90 DEGREE SWIVEL ANGLE, 180 DEGREE ROTATION IN BOTH DIRECTIONS, 40 DEGREE TILT ANGLE
- 2.2 LBS. - 22 LBS. WEIGHT CAPACITY (PER ARM)
- CLAMP TO DESK OR GROMMET MOUNT
- EASY TO ADJUST
- BUILT-IN USB-A/USB-C PORTS

AVAILABLE FINISH: BLACK (BL) WITH BLUE TRIM

**LAPTOP HOLDER ATTACHMENT FOR MONITOR ARM**



|                 |              |          |            |           |           |          |
|-----------------|--------------|----------|------------|-----------|-----------|----------|
| <b>100-LPTP</b> | <b>\$105</b> | <b>4</b> | <b>0.3</b> | <b>12</b> | <b>11</b> | <b>2</b> |
|-----------------|--------------|----------|------------|-----------|-----------|----------|

- COMPATIBLE WITH 100-MA1, 100-MA2, 100-MA1B & 100-MA2B MONITOR ARMS. FITS LAPTOP 11" TO 15.6"
- EASY INSTALL

AVAILABLE FINISH: BLACK (BL)

**HANGING CPU HOLDER**

**TRACK INSTALLED, RETRACTABLE HANGING CPU HOLDER**

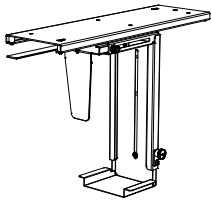

|                 |              |           |            |            |          |                |
|-----------------|--------------|-----------|------------|------------|----------|----------------|
| <b>100-HCPU</b> | <b>\$260</b> | <b>10</b> | <b>0.4</b> | <b>5.5</b> | <b>7</b> | <b>12-20.5</b> |
|-----------------|--------------|-----------|------------|------------|----------|----------------|

- TRACK DEPTH 16"
- SWIVELS 360 DEGREES. SUPPORTS CPU WEIGHT OF UP TO 50LBS. ADJUSTABLE FOR DIFFERENT CPU WIDTHS (3.75"-8.25") & HEIGHTS (12"-20.5").
- RUGGED STEEL CONSTRUCTION. MOUNTING HARDWARE INCLUDED.

AVAILABLE FINISH: BLACK (BL)

**HANGING CPU HOLDER**

**FIXED DESK MOUNT, ADJUSTABLE HANGING CPU HOLDER**

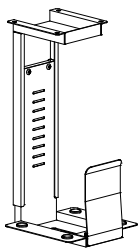

|                   |              |          |          |            |             |            |
|-------------------|--------------|----------|----------|------------|-------------|------------|
| <b>100-2-HCPU</b> | <b>\$188</b> | <b>8</b> | <b>1</b> | <b>ADJ</b> | <b>8.25</b> | <b>ADJ</b> |
|-------------------|--------------|----------|----------|------------|-------------|------------|

- FIXED LOCATION INSTALL. ADJUSTABLE FOR DIFFERENT CPU WIDTHS ( 3.25" - 8" ) & HEIGHTS (15.375" - 21.75")
- DURABLE HEAVY GAUGE STEEL. MOUNTING HARDWARE INCLUDED.

AVAILABLE FINISHES: BLACK (BL) & WHITE (WH)

**WIRE MANAGEMENT TOWER**

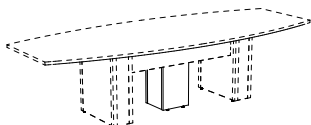
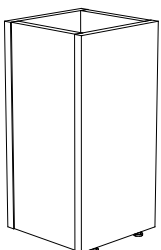

|                    |              |             |             |           |           |              |
|--------------------|--------------|-------------|-------------|-----------|-----------|--------------|
| <b>100-1212WMT</b> | <b>\$357</b> | <b>20.4</b> | <b>0.90</b> | <b>12</b> | <b>12</b> | <b>23.75</b> |
|--------------------|--------------|-------------|-------------|-----------|-----------|--------------|

- 12" SQUARE TOWER
- SAFELY CONTAINS SYSTEM WIRES
- QUICK CLICK WIRE ACCESS
- CUSTOM HEIGHT AVAILABLE

AVAILABLE FINISHES: ALL STANDARD HEARTWOOD LAMINATE FINISHES

| MODEL | LIST | WEIGHT | CUBE            | W  | D  | H  |
|-------|------|--------|-----------------|----|----|----|
|       |      | LBS    | FT <sup>3</sup> | IN | IN | IN |

**22" WIRE MANAGEMENT TRAY**



|                  |              |            |            |              |             |             |
|------------------|--------------|------------|------------|--------------|-------------|-------------|
| <b>100-WMT22</b> | <b>\$108</b> | <b>1.9</b> | <b>.19</b> | <b>21.75</b> | <b>7.25</b> | <b>4.75</b> |
|------------------|--------------|------------|------------|--------------|-------------|-------------|

- INTERLOCKING UNITS FOR EASY EXPANSION
- EASY ACCESSIBILITY

AVAILABLE FINISH: WHITE (WH)

**WIRE MANAGEMENT RACK**

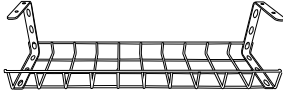

|                       |              |            |             |              |             |          |
|-----------------------|--------------|------------|-------------|--------------|-------------|----------|
| <b>100-WMT22-RACK</b> | <b>\$117</b> | <b>2.6</b> | <b>1.18</b> | <b>22.75</b> | <b>6.25</b> | <b>6</b> |
|-----------------------|--------------|------------|-------------|--------------|-------------|----------|

- INCLUDES MOUNTING HARDWARE

AVAILABLE FINISH: GREY (GR)

**FLOOR WIRE MANAGEMENT**

WIRE MANAGEMENT FOR HEIGHT ADJUSTABLE DESKS  
LENGTH CAN BE EASILY CHANGED BY REMOVING/ADDING LINKS

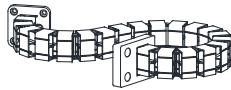

|                   |              |          |            |             |             |              |
|-------------------|--------------|----------|------------|-------------|-------------|--------------|
| <b>100-WM1300</b> | <b>\$127</b> | <b>3</b> | <b>.46</b> | <b>1.75</b> | <b>1.25</b> | <b>51.25</b> |
|-------------------|--------------|----------|------------|-------------|-------------|--------------|

AVAILABLE FINISHES: BLACK (BL), SILVER (SL) & WHITE (WH)

**WIRE MANAGEMENT CHANNEL**

12" LONG

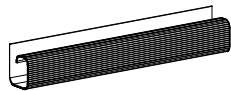

|               |             |          |            |           |            |          |
|---------------|-------------|----------|------------|-----------|------------|----------|
| <b>100-CC</b> | <b>\$20</b> | <b>1</b> | <b>0.1</b> | <b>16</b> | <b>1.5</b> | <b>1</b> |
|---------------|-------------|----------|------------|-----------|------------|----------|

AVAILABLE FINISH: BLACK PLASTIC (BL)

**WIRE MANAGEMENT KIT**

INCLUDES 5 WIRE HANGERS AND MOUNTING HARDWARE.

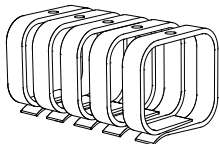

|                 |             |            |            |          |          |            |
|-----------------|-------------|------------|------------|----------|----------|------------|
| <b>100-WIRE</b> | <b>\$73</b> | <b>0.2</b> | <b>0.0</b> | <b>2</b> | <b>2</b> | <b>2.5</b> |
|-----------------|-------------|------------|------------|----------|----------|------------|

AVAILABLE FINISH: LIGHT GREY (GR)

**MONITOR STAND**

MATCHING 2MM EDGE BAND ON EXPOSED EDGES

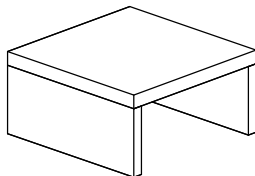

|                   |              |           |          |           |           |          |
|-------------------|--------------|-----------|----------|-----------|-----------|----------|
| <b>100-1212MS</b> | <b>\$169</b> | <b>10</b> | <b>1</b> | <b>12</b> | <b>12</b> | <b>6</b> |
|-------------------|--------------|-----------|----------|-----------|-----------|----------|

AVAILABLE FINISHES: ALL STANDARD HEARTWOOD LAMINATE FINISHES

**16" SWIVEL MONITOR STAND**

ROTATES ON BALL BEARING SWIVEL RING



|                   |              |          |          |           |           |          |
|-------------------|--------------|----------|----------|-----------|-----------|----------|
| <b>100-SWIVEL</b> | <b>\$254</b> | <b>6</b> | <b>1</b> | <b>16</b> | <b>16</b> | <b>2</b> |
|-------------------|--------------|----------|----------|-----------|-----------|----------|

AVAILABLE FINISHES: ALL STANDARD HEARTWOOD LAMINATE COLOURS

| MODEL | LIST | WEIGHT | CUBE            | W  | D  | H  |
|-------|------|--------|-----------------|----|----|----|
|       |      | LBS    | FT <sup>3</sup> | IN | IN | IN |

**EDGE MOUNT BRACKET KIT**

**2PCS**

|                 |             |             |             |          |            |             |
|-----------------|-------------|-------------|-------------|----------|------------|-------------|
| <b>100-EMB2</b> | <b>\$63</b> | <b>0.75</b> | <b>0.02</b> | <b>2</b> | <b>1.5</b> | <b>3.75</b> |
|-----------------|-------------|-------------|-------------|----------|------------|-------------|

**3PCS**

|                 |             |             |             |          |            |             |
|-----------------|-------------|-------------|-------------|----------|------------|-------------|
| <b>100-EMB3</b> | <b>\$93</b> | <b>1.13</b> | <b>0.03</b> | <b>2</b> | <b>1.5</b> | <b>3.75</b> |
|-----------------|-------------|-------------|-------------|----------|------------|-------------|

- WILL CLAMP 1" THICK SURFACES
- MOUNTING HARDWARE INCLUDED
- DURABLE, HIGH-QUALITY ZINC MATERIAL

AVAILABLE FINISHES: BLACK (BL) & SILVER (SL)

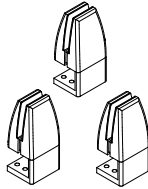
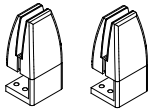

**TOP MOUNT BRACKET KIT**

**2PCS**

|                 |             |             |             |          |            |            |
|-----------------|-------------|-------------|-------------|----------|------------|------------|
| <b>100-TMB2</b> | <b>\$63</b> | <b>0.56</b> | <b>0.01</b> | <b>2</b> | <b>1.5</b> | <b>2.5</b> |
|-----------------|-------------|-------------|-------------|----------|------------|------------|

**3PCS**

|                 |             |             |             |          |            |            |
|-----------------|-------------|-------------|-------------|----------|------------|------------|
| <b>100-TMB3</b> | <b>\$93</b> | <b>0.84</b> | <b>0.02</b> | <b>2</b> | <b>1.5</b> | <b>2.5</b> |
|-----------------|-------------|-------------|-------------|----------|------------|------------|

- WILL CLAMP 1" THICK SURFACES
- MOUNTING HARDWARE INCLUDED
- DURABLE, HIGH-QUALITY ZINC MATERIAL

AVAILABLE FINISHES: BLACK (BL) & SILVER (SL)

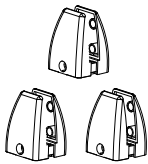

**TASK LIGHTS - FLUORESCENT**

|                 |              |            |             |              |            |             |
|-----------------|--------------|------------|-------------|--------------|------------|-------------|
| <b>100-24TL</b> | <b>\$361</b> | <b>2.1</b> | <b>0.11</b> | <b>24.75</b> | <b>3.5</b> | <b>1.25</b> |
|-----------------|--------------|------------|-------------|--------------|------------|-------------|

|                 |              |            |             |              |            |             |
|-----------------|--------------|------------|-------------|--------------|------------|-------------|
| <b>100-36TL</b> | <b>\$382</b> | <b>2.8</b> | <b>0.12</b> | <b>36.75</b> | <b>3.5</b> | <b>1.25</b> |
|-----------------|--------------|------------|-------------|--------------|------------|-------------|

|                 |              |          |             |              |            |             |
|-----------------|--------------|----------|-------------|--------------|------------|-------------|
| <b>100-48TL</b> | <b>\$473</b> | <b>3</b> | <b>0.14</b> | <b>48.75</b> | <b>3.5</b> | <b>1.25</b> |
|-----------------|--------------|----------|-------------|--------------|------------|-------------|

WHEN ORDERING TASKLIGHTS, PLEASE KEEP IN MIND:

- STANDARD HUTCHES DO NOT INCLUDE A GROMMET
- A CORD SWEEP IS INCLUDED ON THE BOTTOM OF THE HUTCH BACK
- TASK LIGHT INCLUDES A 9FT LONG CORD.
- DUE TO SLIMLINE DESIGN, TASK LIGHTS DO NOT REQUIRE A VALENCE. SWITCH AND CORD ARE ON THE RIGHT END.
- CUL CERTIFIED

AVAILABLE FINISH: BLACK (BL)

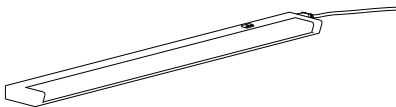

**LED TASK LIGHTS**

|                    |              |            |              |              |            |             |
|--------------------|--------------|------------|--------------|--------------|------------|-------------|
| <b>100-LED36TL</b> | <b>\$437</b> | <b>2.8</b> | <b>0.105</b> | <b>36.75</b> | <b>3.5</b> | <b>1.25</b> |
|--------------------|--------------|------------|--------------|--------------|------------|-------------|

|                    |              |          |             |              |            |             |
|--------------------|--------------|----------|-------------|--------------|------------|-------------|
| <b>100-LED48TL</b> | <b>\$535</b> | <b>3</b> | <b>0.14</b> | <b>48.75</b> | <b>3.5</b> | <b>1.25</b> |
|--------------------|--------------|----------|-------------|--------------|------------|-------------|

- BUILT-IN ON/OFF OCCUPANCY SENSOR
- 160° SWIVEL FEATURE TO POSITION THE LIGHT WHERE NEEDED
- MAX WATTS IS 180W IN LINE
- INCLUDES: 5' GROUNDED POWER CORD, MAGNET FOR METAL SHELF INSTALLATION AND SCREW KIT FOR WOOD SHELF MOUNTING
- CUL CERTIFIED

AVAILABLE FINISH: ALUMINIUM (AL)

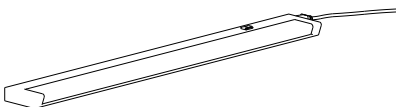

| MODEL | LIST | WEIGHT | CUBE            | W  | D  | H  |
|-------|------|--------|-----------------|----|----|----|
|       |      | LBS    | FT <sup>3</sup> | IN | IN | IN |

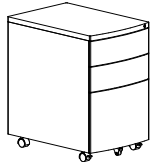

**METAL MOBILE PEDESTAL - FULL CARTON**

BOX / BOX / FILE PEDESTAL. ALL DRAWERS LOCK. LOCKING CASTERS.

|                  |              |           |          |             |             |             |
|------------------|--------------|-----------|----------|-------------|-------------|-------------|
| <b>100-MMPUF</b> | <b>\$540</b> | <b>55</b> | <b>7</b> | <b>15.5</b> | <b>22.5</b> | <b>25.2</b> |
|------------------|--------------|-----------|----------|-------------|-------------|-------------|

FILE / FILE PEDESTAL. ALL DRAWERS LOCK. LOCKING CASTERS.

|                  |              |           |          |             |             |             |
|------------------|--------------|-----------|----------|-------------|-------------|-------------|
| <b>100-MMPFF</b> | <b>\$540</b> | <b>55</b> | <b>7</b> | <b>15.5</b> | <b>22.5</b> | <b>27.1</b> |
|------------------|--------------|-----------|----------|-------------|-------------|-------------|

**NOTE:** METAL MOBILE PEDESTALS CAN BE KEYED ALIKE.

**EXAMPLE:** IF YOU REQUIRE 3 UNITS TO BE KEYED ALIKE, ORDER **100-COREPACK-3 (\$11 X 3=\$33)**

**AVAILABLE FINISHES:** BLACK (BL), TITANIUM (TT) & WHITE (WH)

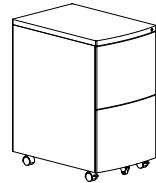

BOX / FILE PEDESTAL. ALL DRAWERS LOCK. LOCKING CASTERS.  
INCLUDES PENCIL TRAY

|                 |              |             |             |             |             |             |
|-----------------|--------------|-------------|-------------|-------------|-------------|-------------|
| <b>100-MMPF</b> | <b>\$499</b> | <b>39.7</b> | <b>4.62</b> | <b>15.5</b> | <b>22.5</b> | <b>20.5</b> |
|-----------------|--------------|-------------|-------------|-------------|-------------|-------------|

**AVAILABLE FINISH:** BLACK (BL) & TITANIUM (TT)

- MEETS & EXCEEDS ANSI/BIFMA STANDARDS.
- MAXIMUM ADDITIONAL WEIGHT CAPACITY - 220LBS (HEAVY-DUTY CASTERS)
- METAL MOBILE PEDESTALS CAN BE KEYED ALIKE: ORDER 100-COREPACK FOR THE NUMBER OF KEYED ALIKE UNITS REQUIRED.

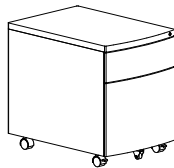

**METAL MOBILE PEDESTAL CUSHION**

FOR USE WITH 100-MMPF ONLY

|                        |              |            |             |              |             |          |
|------------------------|--------------|------------|-------------|--------------|-------------|----------|
| <b>100-MMPF-CUSHFA</b> | <b>\$133</b> | <b>7.7</b> | <b>0.49</b> | <b>15.25</b> | <b>22.5</b> | <b>2</b> |
|------------------------|--------------|------------|-------------|--------------|-------------|----------|

**AVAILABLE FINISHES:** CUSHFA - BLACK (BL), BLUE (BU), LIGHT GREY (GR), RED (RD) & ORANGE (OR)

|                        |              |            |             |              |             |          |
|------------------------|--------------|------------|-------------|--------------|-------------|----------|
| <b>100-MMPF-CUSHPU</b> | <b>\$133</b> | <b>7.7</b> | <b>0.49</b> | <b>15.25</b> | <b>22.5</b> | <b>2</b> |
|------------------------|--------------|------------|-------------|--------------|-------------|----------|

**AVAILABLE FINISH:** CUSHPU - BLACK POLYURETHANE (BL)

- DURABLE POLYESTER OR POLYURETHANE FABRIC MATCHING FINISH CHOICES AVAILABLE IN HDL JUPITER SEATING SERIES (DUNE, ZUMA & ECHO).
- CUSHIONS ATTACH WITH VELCRO STRIPS (SUPPLIED).
- 1 CUSHION PER CARTON.

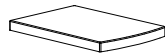

**30" x 20" ANTI-FATIGUE MAT**

|                    |              |            |            |           |             |          |
|--------------------|--------------|------------|------------|-----------|-------------|----------|
| <b>100-2030AFM</b> | <b>\$157</b> | <b>3.3</b> | <b>.48</b> | <b>29</b> | <b>19.5</b> | <b>1</b> |
|--------------------|--------------|------------|------------|-----------|-------------|----------|

- PVC FAUX LEATHER WITH HIGH-DENSITY POLYURETHANE CORE
- EASY CLEAN
- ABLE TO WITHSTAND COMMON HOUSE FLUIDS SUCH AS GREASE & LIQUIDS
- NON-CURLING BEVELLED EDGES

**AVAILABLE FINISH:** BLACK (BL)

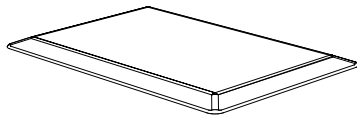

| MODEL | LIST | WEIGHT | CUBE            | W  | D  | H  |
|-------|------|--------|-----------------|----|----|----|
|       |      | LBS    | FT <sup>3</sup> | IN | IN | IN |

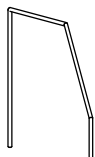

**RECORD DIVIDERS**

SET OF 6

**100-RD \$99**

**NOTE:** HUTCHES ARE NOT DRILLED FOR RECORD DIVIDERS UNLESS SPECIFIED AT TIME OF ORDER

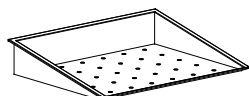

**OUTLINES ACCESSORIES**

**NOTE:** OUTLINES ACCESSORIES ARE LISTED IN THE OUTLINES SERIES SECTION OF THE CATALOGUE

**KEY ALIKE**

**100-COREPACK \$11**

**KEY ALIKE**

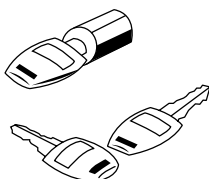

HEARTWOOD SHIPS ALL LOCKING UNITS WITH RANDOM KEY NUMBERS. WHEN YOU NEED TO KEY UNITS ALIKE, ORDER THE 100-COREPACK.

YOU WILL NEED TO ADD THE NUMBER OF CORES YOU REQUIRE TO THE MODEL NUMBER.

FOR EXAMPLE, IF YOU HAVE 4 LOCKS THAT NEED TO BE KEYED ALIKE, ORDER **100-COREPACK-4**. THE CHARGE FOR THIS WILL BE **4 X \$11 = \$44**.

IF YOU NEED 3 CORES, ORDER 1- 100-COREPACK-3 ETC.

WITH EACH 100-COREPACK ORDERED, YOU WILL RECEIVE THE NUMBER OF CORES AND KEYS IN THE MODEL NUMBER

AS WELL AS 1 CORE REMOVAL KEY TO ENABLE YOU TO CHANGE THE CORES.

KEY ALIKE IS COMPATIBLE WITH ALL STANDARD HEARTWOOD LOCKS AND METAL MOBILE PEDESTAL LOCKS.

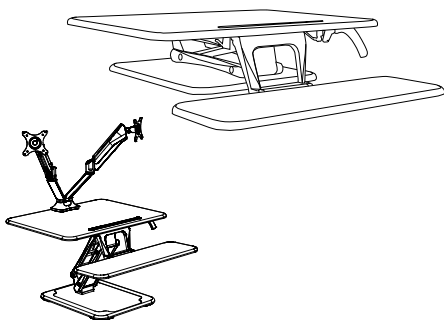

**DESKTOP HEIGHT ADJUSTABLE**

ADJUSTABLE STAND RESTS ON TOP OF EXISTING DESK TO EASILY CONVERT TRADITIONAL DESK TO STANDING DESK

**100-DTHA \$840 50.3 3.8 26.75 29 6.5-16.75**

- ADJUSTS TO HEIGHTS BETWEEN 6.5" & 16.5" WITH A GAS STRUT FOR EASY CUSTOMIZATION.
- MADE OF WOOD FINISHED WITH A LAMINATE COATING FOR DURABILITY WITH A HEAVY BASE FOR STABILITY
- COMPATIBLE WITH PNEUMATIC MONITOR ARMS

AVAILABLE FINISH: BLACK (BL)

**DESKTOP HEIGHT ADJUSTABLE**

SIT-TO-STAND DESK CONVERTER W/ GAS-SPRING LIFTING MECHANISM OFFERS EASY ADJUSTMENT

**100-2-DTHA \$480 29.55 1.06 26 24.2 6.3-17.5**

- HEAVY-DUTY STEEL & MELAMINE CONSTRUCTION FOR MAXIMUM STABILITY, INCLUDES ANTI-SLIP PADS ON BASE
  - SQUEEZE LEVER HEIGHT-ADJUSTMENT DESIGN
  - WORKSURFACE WEIGHT CAPACITY: 13KG / 28.6 LBS
  - KEYBOARD WEIGHT CAPACITY: 2 KG / 4.4 LBS
  - HEIGHT RANGE 160MM - 445 MM / 6.3" - 17.5"
  - COMPATIBLE WITH PNEUMATIC MONITOR ARMS
- SEE 100-MA1, 100-MA2, 100-MA1B & 100-MA2B**

AVAILABLE FINISH: BLACK (BL)

**\*\*SEE ONLINE BROCHURE FOR FURTHER DETAILS.**



| MODEL | LIST | WEIGHT | CUBE            | W  | D  | H  |
|-------|------|--------|-----------------|----|----|----|
|       |      | LBS    | FT <sup>3</sup> | IN | IN | IN |

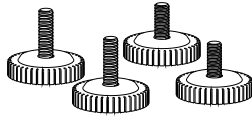

**APOLLO OPTIONAL EXTENDED LEVELER KIT**

COMES W/ 2 X 25MM AND 2 X 35MM LEVELERS.

COMBINE W/ THE SUPPLIED 15MM LEVELERS TO LEVEL A STRAIGHT OR L SHAPED CONFIGURATION.

M10 THREAD

**APO-E1-ELEV      \$28**

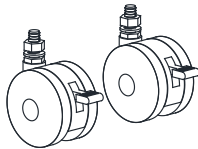

**APOLLO OPTIONAL CASTERS FOR ELECTRIC HEIGHT ADJUSTABLE UNITS**

2 LEG APOLLO ELECTRIC UNIT.

4 PER CARTON. 73MM DIAMETER HEAVY DUTY BLACK LOCKING WHEELS.

M10 THREAD

**APO-E1-2CASTER      \$184**

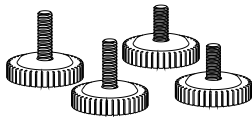

**OLYMPUS OPTIONAL EXTENDED LEVELER KIT**

COMES WITH 2 X 5MM AND 2 X 35MM LEVELERS. COMBINE WITH THE SUPPLIED 15MM LEVELERS TO LEVEL A STRAIGHT OR L SHAPED CONFIGURATION.

M10 THREAD

**OLY-E1-ELEV      \$24**

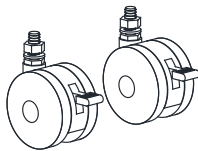

**OLYMPUS OPTIONAL CASTERS FOR ELECTRIC HEIGHT ADJUSTABLE UNITS**

CASTERS FOR 2 LEG OLYMPUS

4 PER CARTON. 73MM DIAMETER HEAVY DUTY BLACK LOCKING WHEELS

M10 THREAD

**OLY-E1-2CASTER      \$160**

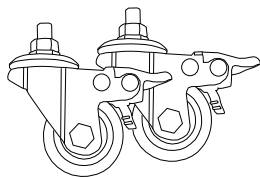

**HEIGHT ADJUSTABLE LOCKING CASTER**

SOLD IN QUANTITY OF 2

**900-CASTER-M8-HD      \$82      .9      .4      1.75      3      2.5**

- M8 THREADED STEM CASTER.
- MAXIMUM WEIGHT PER CASTER IS 30KG/66 LBS.
- DURABLE PVC MATERIAL SAFE FOR USE WITH SOFT OR HARD FLOORS.

**AVAILABLE FINISH:** BLACK (BL)

COMPATIBLE WITH TUCANA BASES AND CALYPSO, RISE, ATHENA, AND ATLAS HEIGHT-ADJUSTABLE BASES.



# 388/600 SERIES

This is a metric series (imperial sizing available). Please refer to page [INDEX-1](#) for details

|  |            |
|--|------------|
| <b>Series Specifications &amp; Description</b> ..... | 388/600-3  |
| <b>Product by Category</b> .....                     |            |
| <b>Desks</b> .....                                   |            |
| Pedestal Desks .....                                 | 388/600-7  |
| Desk Shells .....                                    | 388/600-9  |
| <b>Returns</b> .....                                 |            |
| Bridge Returns .....                                 | 388/600-11 |
| Pedestal Returns .....                               | 388/600-11 |
| Return Shells .....                                  | 388/600-12 |
| <b>Connector Tops</b> .....                          |            |
| Connector Tops-24" (Straight & Cutback) .....        | 388/600-13 |
| Connector Tops-30" (Straight & Cutback) .....        | 388/600-15 |
| <b>Corner Modules</b> .....                          |            |
| Corner Module .....                                  | 388/600-17 |
| Neo-Angle Corner Modules .....                       | 388/600-17 |
| Neo Angle Corner Wedges .....                        | 388/600-17 |
| Corner Module Desks .....                            | 388/600-18 |
| Extended Corner Modules .....                        | 388/600-19 |
| Corner Modules Peninsula Tops .....                  | 388/600-20 |
| <b>Metal Legs</b> .....                              | 388/600-24 |
| <b>Peninsula Tops</b> .....                          | 388/600-21 |
| <b>Tables</b> .....                                  | 388/600-25 |
| Bullet Tables .....                                  | 388/600-25 |
| Wedge Bullet Tables .....                            | 388/600-26 |
| Shared Community Tables .....                        | 388/600-29 |
| Magazine Tables .....                                | 388/600-30 |
| <b>Drawer Pedestals</b> .....                        | 388/600-30 |
| <b>Credenzas</b> .....                               | 388/600-33 |
| <b>Storage Cabinets</b> .....                        |            |
| Lateral File Storage .....                           | 388/600-35 |
| Cabinet Storage .....                                | 388/600-37 |
| Open Storage Cabinets .....                          | 388/600-42 |
| Mobile Storage Cabinets .....                        | 388/600-43 |

**continued...**

|  |             |
|--|-------------|
| <b>Mid-Height Storage</b> .....                      |             |
| Boardroom-Height Storage Cabinets .....              | 388/600-44  |
| Mid-Height Storage Cabinets .....                    | 388/600-46  |
| Mid-Height Wardrobe Storage .....                    | 388/600-47  |
| <b>Tall Storage</b> .....                            |             |
| Tall Storage Cabinets .....                          | 388/600-50  |
| Wardrobe Storage .....                               | 388/600-56  |
| <b>Hutches &amp; Accessories</b> .....               |             |
| Open Hutches .....                                   | 388/600-63  |
| Hinged Door Hutches .....                            | 388/600-65  |
| Flipper Door Hutches .....                           | 388/600-67  |
| Tackboards .....                                     | 388/600-68  |
| Hutch Accessories .....                              | 388/600-70  |
| <b>Desktop Organizers</b> .....                      | 388/600-71  |
| <b>Mail Sorts</b> .....                              | 388/600-72  |
| <b>Desktop Storage</b> .....                         |             |
| Open Desktop Storage .....                           | 388/600-73  |
| Hinged Door Desktop Storage .....                    | 388/600-74  |
| Hinged Door Desktop Cabinet .....                    | 388/600-76  |
| <b>Overhead Storage</b> .....                        |             |
| Open Overhead Storage .....                          | 388/600-78  |
| Hinged Door Overhead Storage .....                   | 388/600-79  |
| Flipper Door Overhead Storage .....                  | 388/600-80  |
| <b>Stacking Storage</b> .....                        |             |
| Stacking Bookcase .....                              | 388/600-81  |
| Stacking Hinged Door Cabinet .....                   | 388/600-82  |
| <b>Flip Top Storage Benches &amp; Cushions</b> ..... | 388/600-84  |
| <b>Bookcases</b> .....                               | 388/600-84  |
| <b>Curved Bookcases</b> .....                        | 388/600-85  |
| <b>Corner Shelves</b> .....                          |             |
| Square Corner Shelves .....                          | 388/600-87  |
| Corner Shelves .....                                 | 388/600-89  |
| <b>Transaction Shelves</b> .....                     | 388/600-91  |
| <b>Gallery Shells</b> .....                          | 388/600-91  |
| <b>Campus Collection</b> .....                       | 388/600-92  |
| <b>Lockers</b> .....                                 | 388/600-96  |
| <b>388/600 Series Layouts</b> .....                  | 388/600-103 |

**NOTE:** Information is current at time of print. For up to date information check online at [www.heartwood.ca](http://www.heartwood.ca).

## Features

- ♥ Choose between standard 1" tops or the executive styling of 1½" tops (optional fluted or non-fluted tops).
- ♥ Black "shadow" strip or matching equivalent below tops on most components (see chart).
- ♥ Silver "highlight" strip below tops on Evening Zen and Winter Wood finishes.
- ♥ Over 800 components per series and ≈20 finishes to choose from.
- ♥ Leveling glides on all floor components.
- ♥ Two-tone combinations available at no extra charge.
- ♥ Any handle style available at no extra charge.
- ♥ Soft close hinges are standard
- ♥ Compatible with HDL's Innovations

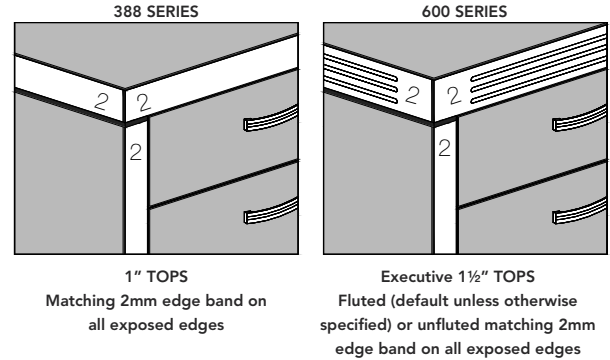

## Finishes

| LAMINATES |                    | SUITABLE FOR |          |        | DEFAULT FINISHES |                              |                        |              |                 |
|-----------|--------------------|--------------|----------|--------|------------------|------------------------------|------------------------|--------------|-----------------|
| ABBR      | LAMINATE COLOUR    | 1" TOPS      | 1½" TOPS | BASE   | MATCHING EDGE    | SHADOW STRIP (BLACK DEFAULT) | HANDLES- (BLACK SCOOP) | LOCK (BLACK) | GROMMET (BLACK) |
| AM        | Autumn Maple       | ✓            | ✓        | ✓      | ✓                | ✓                            | ✓                      | ✓            | ✓               |
| BL        | Black              | ✗            | ✗        | ✓      | ✓                | ✓                            | ✓                      | ✓            | ✓               |
| BW        | Black Walnut       | ✓            | ✓        | ✓      | ✓                | ✓                            | ✓                      | ✓            | ✓               |
| CD        | Cappuccino Dream** | ✓            | ✓        | ✓      | ✓                | ✓                            | ✓                      | ✓            | ✓               |
| CM        | Charcoal Matrix    | ✓            | ✓        | ✓      | Black            | ✓                            | ✓                      | ✓            | ✓               |
| DE        | Desert Sand        | ✓            | ✓        | ✓      | ✓                | Matching                     | ✓                      | ✓            | ✓               |
| DD        | Driftwood***       | ✓            | ✓        | ✓ (1") | ✓                | Matching                     | ✓                      | ✓            | ✓               |
| DW        | Driftwood Grey**   | ✗            | ✗        | ✓ (¾") | ✓                | Matching                     | ✓                      | ✓            | ✓               |
| EZ        | Evening Zen        | ✓            | ✓        | ✓      | ✓                | Silver                       | Aluminium              | ✓            | ✓               |
| GA        | Golden Ash         | ✓            | ✓        | ✓      | ✓                | ✓                            | Black Bar              | ✓            | ✓               |
| GT        | Graphite           | ✗            | ✗        | ✓      | ✓                | ✓                            | ✓                      | ✓            | ✓               |
| GR        | Grey               | ✓            | ✓        | ✓      | ✓                | Matching                     | ✓                      | ✓            | ✓               |
| GD        | Grey Dusk          | ✓            | ✓        | ✓      | ✓                | ✓                            | Aluminium              | ✓            | ✓               |
| GM        | Grey Matrix        | ✓            | ✓        | ✓      | Grey             | ✓                            | ✓                      | ✓            | ✓               |
| HM        | Hardrock Maple     | ✓            | ✓        | ✓      | ✓                | ✓                            | ✓                      | ✓            | ✓               |
| NC        | Noce Cocoa         | ✓            | ✓        | ✓      | ✓                | Matching                     | Aluminium Bar          | Silver       | Grey            |
| PW        | Pure White         | ✓            | ✓        | ✓      | ✓                | Matching                     | Aluminium              | Silver       | Grey            |
| RM        | Royal Mahogany     | ✓            | ✓        | ✓      | ✓                | ✓                            | ✓                      | ✓            | ✓               |
| SM        | Sugar Maple        | ✓            | ✓        | ✓      | ✓                | ✓                            | ✓                      | ✓            | ✓               |
| SW        | Seaside White      | ✓            | ✓        | ✓      | ✓                | Matching                     | Aluminium              | Silver       | Grey            |
| VA        | Volcanic Ash       | ✓            | ✓        | ✓      | ✓                | Matching                     | Black Bar              | ✓            | ✓               |
| WW        | Winter Wood        | ✓            | ✓        | ✓      | ✓                | Matching                     | Aluminium Bar          | Silver       | Grey            |

\*\* Textured Finish

\*\*\* Non-textured Finish 1" & 1½" only

**High Pressure (HP) laminate available. Contact Customer Service**

## Construction

- ♥ 388 Series tops and gables are 1" thick.
- ♥ 600 Series tops are 1½" and gables are 1" thick.
- ♥ Modesty panels are ¾" thick.
- ♥ All are thermally fused laminate on a 45lb industrial particle board core.
- ♥ Leveling glides are standard on all floor models.

**Edge Detail:**

- ♥ Edges: 388 and 600 exposed edges all finished in a matching 2mm edge banding.  
> Banding changes to an alternate Heartwood standard colour are available at no extra charge.
- ♥ 1½" Tops: Fluted top edges are **default for 600 Series. Items WILL BE fluted unless otherwise noted on your PO.** Unfluted, flat edge available at no extra charge.
- ♥ Highlight/shadow/matching strip: Highlight/shadow/matching equivalent strip detail below tops on most components (see chart).

**Corner Module Profile:**

- ♥ Two standard contour profiles are available for corner module tops:
  - **CM** - traditional cutback
  - **RCM** - RADIUS corner module

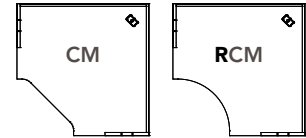

**NOTE:** Does not apply to Neo-angle wedge. For custom shapes contact customer service.

**Extended Corner Module Profiles:**

- ♥ Four standard contour profiles are available for extended corner module tops at no additional upcharge:
  - **CM** - traditional cutback
  - **\*SCM** - Scooped extended corner module
  - **RCM** - RADIUS extended corner module
  - **JCM** - J extended corner module

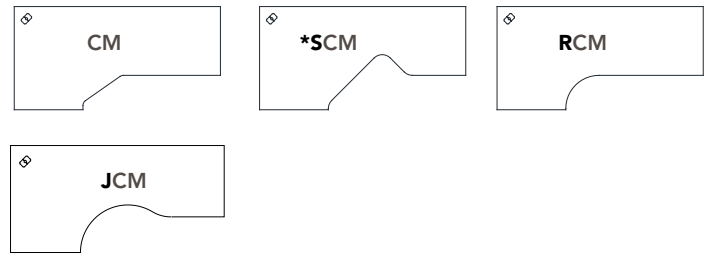

To order simply change the suffix accordingly  
> **Ordering Example:** 388-3666CM for standard profile and 388-3666SCM for scooped corner module profile.

For custom shapes contact customer service.

\* We recommend cutback connecting returns to fit best with **SCM shape** units.

**Gable Sets:**

- ♥ Corner modules, extended corner modules and connector tops must be ordered with the required gable set.

- A:** Gable set comes with 2 wide gables
- B:** Gable set comes with 1 wide and 1 narrow gable
- C:** Gable set comes with 2 narrow gables

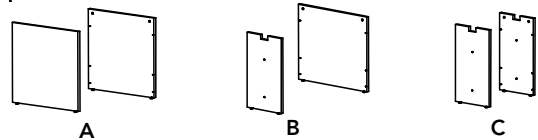

> **Ordering Example:** 388-2472CT-C

- ♥ Unsupported units over 72" (388 Series) or over 84" (600 Series) require a center support Gable. Add +C to Sku and upcharge of \$198.

> **Ordering Example:** 388-2490CT-B+C



**Modesty Panels:**

- ♥ Flush modesty panels are standard on all corner modules and connector tops.
- ♥ Recessed modesty panels available on request. Standard recess is 2 1/2".  
> **Ordering Example:** (add "R" before unit size) 388-R2442CM-C
- ♥ 30" desks have a 4" recessed MP; 36" desks have a 10" recessed MP.
- ♥ Other components have flush modesty panels unless otherwise noted.
- ♥ All modesty panels are FULL. ½ or ¾ height MP available at no extra charge on most units.

For ½ height modesty add **2** to the Sku:

> **Ordering Example:** 388-3072CT-B2 ( B gable set with ½ height modesty)

For ¾ height modesty add **3** to the Sku:

> **Ordering Example:** 388-3072CT-C3 ( C gable set with ¾ height modesty)

All modesty panels on a component are raised equally. Contact Customer Service if not all modesties are to be raised.

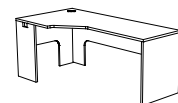

½ HEIGHT MODESTY

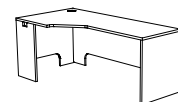

¾ HEIGHT MODESTY

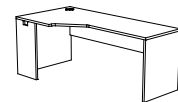

Call Customer Service

**Metal Legs:**

- ♥ Peninsula top price book images show a components' default leg. Other leg options are available, no extra charge:
  - 5" round legs add - RL5 (Black - BL)
  - 3" square legs add - SQ3 (Silver - SL or Black - BL)
  - 2.5" round legs add - RL2.5 (Silver - SL or Black - BL)
  - > **Ordering Example:** 388-3072BTG default 5" round leg. 388-3072BTG-**SQ3-SL** for square silver leg
- ♥ Peninsula price book images shown with laminate gable leg can have metal legs. Same options apply but an upcharge of **\$156** list will be applied per leg substitution.
  - > **Ordering Example:** 388-3072BTGM - default laminate gable leg.  
 388-3072BTGM-**GD-SQ3-SL** for square leg

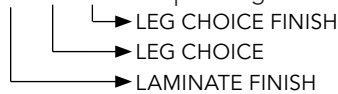

**Drawers:**

- ♥ Laminate units
  - ♥ All drawers are 5 pieces - 4 x 1/2" black sides & 1 x 1/8" black bottom.
  - ♥ All drawers and doors have handles except hutch doors. Hutch door handles may be added by request.  
 See page **ACC 100-3** for selection details.
  - ♥ All box and file drawers mounted on full extension ball bearing slides, 75lb load rating.
  - ♥ Lateral file drawers mounted on full extension ball bearing slides, 100lb load rating.
  - ♥ Each file drawer features side rails and adjustable file bars that accommodate front-to-back letter or side to side legal sized hanging folders.
  - ♥ One pencil tray included with every box drawer unit.
- NOTE:** All file and lateral file drawers are constructed to support hanging file folders. Broken drawer bottoms are not covered by warranty. If you expect to store heavy items, ie. phone books, paper etc. on the drawer bottom, we offer an optional 1/2" bottom for these drawers. Please contact Customer Service for pricing.

**Doors:**

- ♥ All cabinet, hutch and wardrobes now include **soft close hinge** doors.
- ♥ Our **NEW** writeable / wipeable White Board (WB) laminate is available for door applications.

**Handles:**

- ♥ Any standard handle style available at no extra charge.
  - ♥ 388 Series default is black/aluminium Scoop handles. Please specify choice if other than Scoop.
- Exceptions:    AGD plexiglass doors - default handle Bar Aluminium  
                          Winter Wood and Seaside White - default handle Bar Aluminium  
                          Lockers - default handle Bar
- ♥ 600 Series does not have a default handle and must be specified on your PO. **For handle choices see page ACC 100-3.**
  - ♥ As Handle choices are component specific, please clearly indicate your handle choices for each component on your PO. It is possible for different components to have different handle choices on the same PO.
  - ♥ All drawers and doors have handles except for hutch doors. Hutch door handles may be added for an up-charge of **\$38** per handle

**Glazed Doors and Panels:**

- ♥ All glazed doors and panels consist of an aluminum frame with a 5mm plexiglass panel.
- ♥ The prices for aluminum frame glazed doors is an upcharge and must be added to the base price of the unit it goes on.
- ♥ AGD doors are not locking by default, add **-L** to the SKU and upcharge of **\$76**
- ♥ Doors include silver finish, bar handles (except on hutches and overheads which do not need handles).
- ♥ Frames have a natural, brushed aluminum finish. (HML AGD doors differ from HDL and will not match if paired together)
- ♥ Plexiglass panels are available in 3 styles:
  - > Clear            (CL)
  - > Frosted        (FR)
  - > Bronze         (BR)

Please indicate on your PO which plexiglass style you would like.

| Bootshelf Upcharges |              |
|---------------------|--------------|
| 12"w to 23"w        | <b>\$119</b> |
| 24"w to 35"w        | <b>\$134</b> |
| 36"w or >           | <b>\$174</b> |

**Optional Boot Shelves:**

- ♥ All tall & mid-height wardrobe storage & storage cabinets can have an optional boot shelf. Upcharges apply when ordering bootshelf: add **-BS** to product SKU.
- > **Ordering Example:** 388-4724CWR-24-**BS**

**Locks:**

- ♥ All tall cabinet and storage cabinet laminate doors and drawers lock, **except where noted in price book.**
  - ♥ To add an optional lock to a component or Aluminum Glazed Doors (AGD), add **-L** to the SKU and upcharge of **\$76**
  - ♥ Hutch and overhead storage doors do not lock, unless requested. There is a **\$76** upcharge.
  - ♥ Core removable locks are standard on all drawer pedestals, lateral files and storage cabinets.
    - > For keyed-alike locks, indicate on your order, which standard units you would like keyed-alike.
    - > Order the appropriate quantity of like numbered cores required at **\$11** each.
- Ordering Example:** If you require 3 units to be keyed-alike, **order 100-COREPACK-3 (\$11 x 3 = \$33).**

**388 vs 600 Compatibility:**

- ♥ All no top units are compatible with both 388 and 600 Series
- ♥ For matching hutches, desktop storage and tall storage heights, order **like** Series.
  - > **Ordering Example:** order 600-4372HHD with 600-7224CLC-L
  - > **Ordering Example:** order 388-3672HHD with 388-6524CLC-L
- ♥ To order components with 1½" tops change SKU to 600 and use pricing from 600 Series column.
  - > **Ordering Example:** for 388-3072DS with 1½" top order **600-3072DS**

**Accessories:**

- ♥ See 100 Series (**ACC**) for a complete list of keyboard trays, pencil drawers, grommets, task lighting, CPU holders, etc
- ♥ Monitor arms are available in Black (BL) and Silver (SL) finish and can be both grommet mounted or clamp mounted.

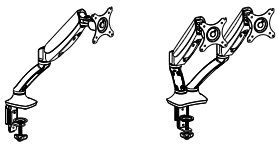

Single mount :**100-MA1**  
Dual mount: **100-MA2**

- ♥ Record dividers are available for all hutches, overhead storage, desktop storage, desktop cabinets, stacking bookcases and stacking cabinets. Shelves are not drilled for record dividers unless **clearly** specified on the PO

388-3636H showing optional record dividers: **100-RD**

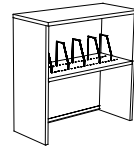

- ♥ The 100 Series now has expanded options for power and data management. See the new power grommet options 100 Series page **100-3.**

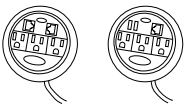

Flip Top Power Grommets with Data: **100-FTP-DATA**  
Flip Top Power Grommets with USB: **100-FTP-USB**

**Custom Sizes:**

- ♥ Custom available.....call Customer Service. Please specify quote number when ordering.
- ♥ Custom widths available... For simple changes, use the price of the next model size up.
  - > **Ordering Example:** for the price of a **388-2766DS**: Take the price of **the next larger size...388-3066DS - \$837**
- NOTE:** If doors, drawers or height are involved, or if there is no next size up, please contact Customer Service for a quote.
- ♥ Custom high-pressure laminate available, contact Customer Service for more informatio.

**Shipping:**

- ♥ Some items are shipped fully assembled, some are shipped in RTA cartoning.
- ♥ Look for RTA symbol (**RTA**) at each model number.
- ♥ Weights and cubes shown are approximates and based on 388 Series.

**High Pressure Laminate:**

- ♥ High-pressure finishes are approximations and not exact matches to Heartwood Manufacturing finishes. For more detailed finish information, please see the manufacturer's swatch (corresponding codes provided on HPL swatch card).
- ♥ See [heartwood.ca](http://heartwood.ca) for all available laminate and high pressure laminate finish.
- ♥ For custom high-pressure pressure matches or alternate choices, contact Customer Service for a quote [cs@heartwood.ca](mailto:cs@heartwood.ca)



| MODEL | 388  | 600  | WEIGHT | CUBE | W | D | 388 | 600 |
|-------|------|------|--------|------|---|---|-----|-----|
|       | LIST | LIST |        |      |   |   | H   | H   |
|       | 1"   | 1½"  |        |      |   |   | 1"  | 1½" |

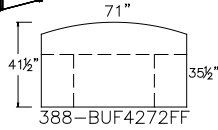
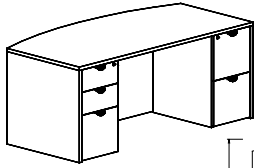

**DOUBLE PEDESTAL BOW TOP DESK**

BOX / BOX / FILE & FILE / FILE. MP RECESSED 10" AT GABLE.

|               |         |         |     |    |    |      |    |      |
|---------------|---------|---------|-----|----|----|------|----|------|
| 388-BUF3672FF | \$2,329 | \$2,655 | 325 | 55 | 71 | 35.5 | 29 | 29.5 |
| 388-BUF4272FF | \$2,351 | \$2,680 | 330 | 60 | 71 | 41.5 | 29 | 29.5 |

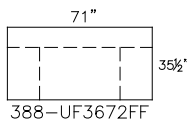
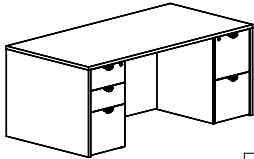

**DOUBLE PEDESTAL DESK**

BOX / BOX / FILE & FILE / FILE. 30" DESK MP RECESSED 4", 36" DESK MP RECESSED 10".

|              |         |         |     |    |       |      |    |      |
|--------------|---------|---------|-----|----|-------|------|----|------|
| 388-UF3060FF | \$1,768 | \$2,016 | 250 | 35 | 59.25 | 29.5 | 29 | 29.5 |
| 388-UF3066FF | \$2,018 | \$2,301 | 265 | 39 | 65    | 29.5 | 29 | 29.5 |
| 388-UF3672FF | \$2,101 | \$2,395 | 320 | 52 | 71    | 35.5 | 29 | 29.5 |

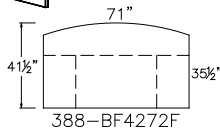
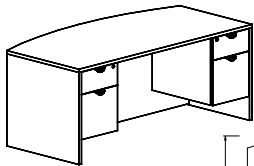

**DOUBLE PEDESTAL BOW TOP DESK**

BOX / FILE & BOX / FILE. MP RECESSED 10" AT GABLE.

|             |         |         |     |    |    |      |    |      |
|-------------|---------|---------|-----|----|----|------|----|------|
| 388-BF3672F | \$1,845 | \$2,103 | 285 | 55 | 71 | 35.5 | 29 | 29.5 |
| 388-BF4272F | \$1,866 | \$2,127 | 290 | 60 | 71 | 41.5 | 29 | 29.5 |

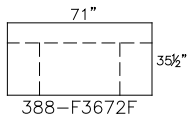
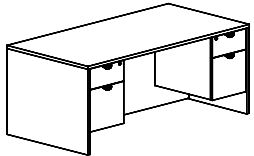

**DOUBLE PEDESTAL DESK**

BOX / FILE & BOX / FILE. 30" DESK MP RECESSED 4", 36" DESK MP RECESSED 10".

|            |         |         |     |    |       |      |    |      |
|------------|---------|---------|-----|----|-------|------|----|------|
| 388-F3060F | \$1,413 | \$1,611 | 210 | 35 | 59.25 | 29.5 | 29 | 29.5 |
| 388-F3066F | \$1,498 | \$1,708 | 225 | 39 | 65    | 29.5 | 29 | 29.5 |
| 388-F3672F | \$1,557 | \$1,775 | 280 | 52 | 71    | 35.5 | 29 | 29.5 |

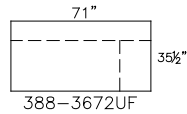
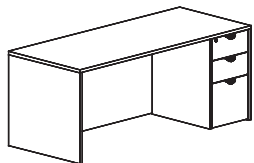

**SINGLE RIGHT PEDESTAL DESK**

BOX / BOX / FILE. 30" DESK MP RECESSED 4", 36" DESK MP RECESSED 10".

|            |         |         |     |    |       |      |    |      |
|------------|---------|---------|-----|----|-------|------|----|------|
| 388-3048UF | \$1,246 | \$1,420 | 170 | 30 | 47.25 | 29.5 | 29 | 29.5 |
| 388-3060UF | \$1,336 | \$1,523 | 210 | 35 | 59.25 | 29.5 | 29 | 29.5 |
| 388-3066UF | \$1,379 | \$1,572 | 220 | 39 | 65    | 29.5 | 29 | 29.5 |
| 388-3072UF | \$1,472 | \$1,678 | 230 | 43 | 71    | 29.5 | 29 | 29.5 |
| 388-3672UF | \$1,488 | \$1,696 | 255 | 52 | 71    | 35.5 | 29 | 29.5 |

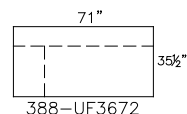
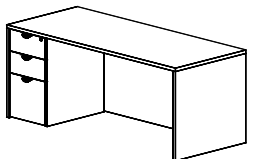

**SINGLE LEFT PEDESTAL DESK**

BOX / BOX / FILE. 30" DESK MP RECESSED 4", 36" DESK MP RECESSED 10".

|            |         |         |     |    |       |      |    |      |
|------------|---------|---------|-----|----|-------|------|----|------|
| 388-UF3048 | \$1,246 | \$1,420 | 170 | 30 | 47.25 | 29.5 | 29 | 29.5 |
| 388-UF3060 | \$1,336 | \$1,523 | 210 | 35 | 59.25 | 29.5 | 29 | 29.5 |
| 388-UF3066 | \$1,379 | \$1,572 | 220 | 39 | 65    | 29.5 | 29 | 29.5 |
| 388-UF3072 | \$1,472 | \$1,678 | 230 | 43 | 71    | 29.5 | 29 | 29.5 |
| 388-UF3672 | \$1,488 | \$1,696 | 255 | 52 | 71    | 35.5 | 29 | 29.5 |

# 388/600 DESKS

## PEDESTAL DESKS

| MODEL | 388  | 600  | WEIGHT | CUBE | W | D | 388 | 600 |
|-------|------|------|--------|------|---|---|-----|-----|
|       | LIST | LIST |        |      |   |   | H   | H   |
|       | 1"   | 1½"  |        |      |   |   | 1"  | 1½" |

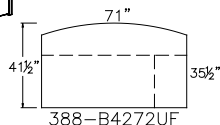
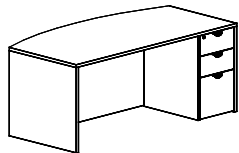

### SINGLE RIGHT PEDESTAL BOW TOP DESK

BOX / BOX / FILE. MP RECESSED 10" AT GABLE.

|             |         |         |     |    |    |      |    |      |
|-------------|---------|---------|-----|----|----|------|----|------|
| 388-B3672UF | \$1,717 | \$1,957 | 260 | 55 | 71 | 35.5 | 29 | 29.5 |
| 388-B4272UF | \$1,769 | \$2,017 | 265 | 60 | 71 | 41.5 | 29 | 29.5 |

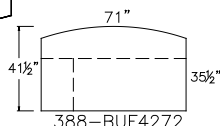
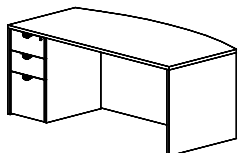

### SINGLE LEFT PEDESTAL BOW TOP DESK

BOX / BOX / FILE. MP RECESSED 10" AT GABLE.

|             |         |         |     |    |    |      |    |      |
|-------------|---------|---------|-----|----|----|------|----|------|
| 388-BUF3672 | \$1,717 | \$1,957 | 260 | 55 | 71 | 35.5 | 29 | 29.5 |
| 388-BUF4272 | \$1,769 | \$2,017 | 265 | 60 | 71 | 41.5 | 29 | 29.5 |

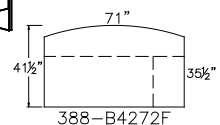
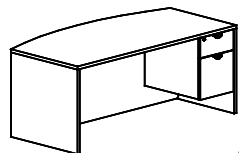

### SINGLE RIGHT PEDESTAL BOW TOP DESK

BOX / FILE. MP RECESSED 10" AT GABLE.

|            |         |         |     |    |    |      |    |      |
|------------|---------|---------|-----|----|----|------|----|------|
| 388-B3672F | \$1,469 | \$1,675 | 240 | 55 | 71 | 35.5 | 29 | 29.5 |
| 388-B4272F | \$1,533 | \$1,748 | 245 | 60 | 71 | 41.5 | 29 | 29.5 |

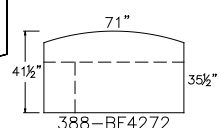
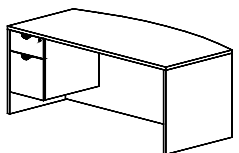

### SINGLE LEFT PEDESTAL BOW TOP DESK

BOX / FILE. MP RECESSED 10" AT GABLE.

|            |         |         |     |    |    |      |    |      |
|------------|---------|---------|-----|----|----|------|----|------|
| 388-BF3672 | \$1,469 | \$1,675 | 240 | 55 | 71 | 35.5 | 29 | 29.5 |
| 388-BF4272 | \$1,533 | \$1,748 | 245 | 60 | 71 | 41.5 | 29 | 29.5 |

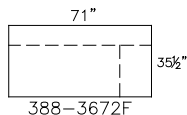
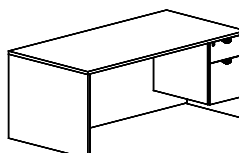

### SINGLE RIGHT PEDESTAL DESK

BOX / FILE. 30" DESK MP RECESSED 4", 36" DESK MP RECESSED 10".

|           |         |         |     |    |       |      |    |      |
|-----------|---------|---------|-----|----|-------|------|----|------|
| 388-3048F | \$1,065 | \$1,214 | 150 | 30 | 47.25 | 29.5 | 29 | 29.5 |
| 388-3060F | \$1,158 | \$1,320 | 190 | 35 | 59.25 | 29.5 | 29 | 29.5 |
| 388-3066F | \$1,222 | \$1,393 | 200 | 39 | 65    | 29.5 | 29 | 29.5 |
| 388-3072F | \$1,304 | \$1,487 | 220 | 43 | 71    | 29.5 | 29 | 29.5 |
| 388-3672F | \$1,321 | \$1,506 | 235 | 52 | 71    | 35.5 | 29 | 29.5 |

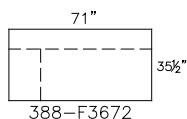
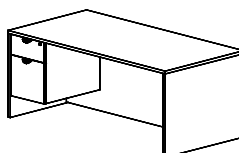

### SINGLE LEFT PEDESTAL DESK

BOX / FILE. 30" DESK MP RECESSED 4", 36" DESK MP RECESSED 10".

|           |         |         |     |    |       |      |    |      |
|-----------|---------|---------|-----|----|-------|------|----|------|
| 388-F3048 | \$1,065 | \$1,214 | 150 | 30 | 47.25 | 29.5 | 29 | 29.5 |
| 388-F3060 | \$1,158 | \$1,320 | 190 | 35 | 59.25 | 29.5 | 29 | 29.5 |
| 388-F3066 | \$1,222 | \$1,393 | 200 | 39 | 65    | 29.5 | 29 | 29.5 |
| 388-F3072 | \$1,304 | \$1,487 | 220 | 43 | 71    | 29.5 | 29 | 29.5 |
| 388-F3672 | \$1,321 | \$1,506 | 235 | 52 | 71    | 35.5 | 29 | 29.5 |

| MODEL | 388  | 600  | WEIGHT | CUBE | W | D | 388 | 600 |
|-------|------|------|--------|------|---|---|-----|-----|
|       | LIST | LIST |        |      |   |   | H   | H   |
|       | 1"   | 1½"  |        |      |   |   | 1"  | 1½" |

**BOW TOP DESK SHELL**

MP RECESSED 10" AT GABLE

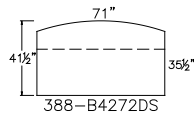
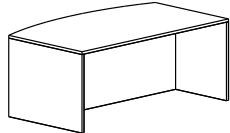

**RTA**

|             |          |          |     |     |       |      |    |      |
|-------------|----------|----------|-----|-----|-------|------|----|------|
| 388-B3672DS | \$1,193  | \$1,360  | 200 | 6   | 71    | 35.5 | 29 | 29.5 |
| 388-B3678DS | \$1,275* | \$1,454  | 210 | 7   | 77    | 35.5 | 29 | 29.5 |
| 388-B3684DS | \$1,343* | \$1,531  | 220 | 7.5 | 82.75 | 35.5 | 29 | 29.5 |
| 388-B3690DS | \$1,498* | \$1,708* | 235 | 7.7 | 88.75 | 35.5 | 29 | 29.5 |
| 388-B3696DS | \$1,650* | \$1,881* | 250 | 8   | 94.5  | 35.5 | 29 | 29.5 |

|             |          |          |     |     |       |      |    |      |
|-------------|----------|----------|-----|-----|-------|------|----|------|
| 388-B4272DS | \$1,235  | \$1,408  | 210 | 7   | 71    | 41.5 | 29 | 29.5 |
| 388-B4278DS | \$1,389* | \$1,583  | 225 | 7.5 | 77    | 41.5 | 29 | 29.5 |
| 388-B4284DS | \$1,456* | \$1,660  | 235 | 8   | 82.75 | 41.5 | 29 | 29.5 |
| 388-B4290DS | \$1,613* | \$1,839* | 250 | 9   | 88.75 | 41.5 | 29 | 29.5 |
| 388-B4296DS | \$1,776* | \$2,025* | 265 | 11  | 94.5  | 41.5 | 29 | 29.5 |

- \*UNSUPPORTED UNITS OVER 72" (388) OR OVER 84" (600) REQUIRE CENTER SUPPORT GABLE. ADD +C TO SKU & UPCHARGE OF \$198
- MODESTY PANEL CAN BE TWO-TONED AT NO EXTRA CHARGE

**DESK SHELL**

30" DESK MP RECESSED 4", 36" DESK MP RECESSED 10"

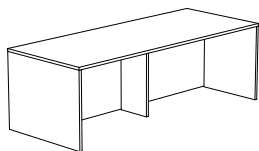

388-3090DS-C

|            |          |          |     |     |       |      |    |      |
|------------|----------|----------|-----|-----|-------|------|----|------|
| 388-3060DS | \$803    | \$915    | 165 | 4.5 | 59.25 | 29.5 | 29 | 29.5 |
| 388-3066DS | \$837    | \$954    | 170 | 5   | 65    | 29.5 | 29 | 29.5 |
| 388-3072DS | \$878    | \$1,001  | 175 | 5.5 | 71    | 29.5 | 29 | 29.5 |
| 388-3078DS | \$993*   | \$1,132  | 190 | 7   | 77    | 29.5 | 29 | 29.5 |
| 388-3084DS | \$1,025* | \$1,169  | 200 | 7.5 | 82.75 | 29.5 | 29 | 29.5 |
| 388-3090DS | \$1,244* | \$1,418* | 215 | 7.7 | 88.75 | 29.5 | 29 | 29.5 |
| 388-3096DS | \$1,352* | \$1,541* | 230 | 7.7 | 94.5  | 29.5 | 29 | 29.5 |

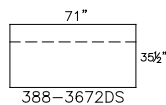
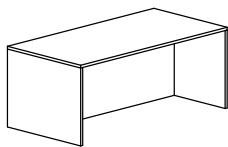

**RTA**

|            |          |          |     |     |       |      |    |      |
|------------|----------|----------|-----|-----|-------|------|----|------|
| 388-3672DS | \$1,077  | \$1,228  | 180 | 6   | 71    | 35.5 | 29 | 29.5 |
| 388-3678DS | \$1,117* | \$1,273  | 200 | 7   | 77    | 35.5 | 29 | 29.5 |
| 388-3684DS | \$1,176* | \$1,341  | 210 | 7.5 | 82.75 | 35.5 | 29 | 29.5 |
| 388-3690DS | \$1,394* | \$1,589* | 225 | 7.7 | 88.75 | 35.5 | 29 | 29.5 |
| 388-3696DS | \$1,500* | \$1,710* | 240 | 8   | 94.5  | 35.5 | 29 | 29.5 |

- \*UNSUPPORTED UNITS OVER 72" (388) OR OVER 84" (600) REQUIRE CENTER SUPPORT GABLE. ADD +C TO SKU & UPCHARGE OF \$198
- MODESTY PANEL CAN BE TWO-TONED AT NO EXTRA CHARGE

FOR CORNER MODULE DESKS- REFER PAGE [388/600-18](#)

# 388/600 DESKS

## DESK SHELLS

| MODEL | 388  | 600  | WEIGHT | CUBE | W | D | 388 | 600 |
|-------|------|------|--------|------|---|---|-----|-----|
|       | LIST | LIST |        |      |   |   | H   | H   |
|       | 1"   | 1½"  |        |      |   |   | 1"  | 1½" |

### CENTER MODESTY DESK SHELL

MODESTY PANEL IS CENTERED, 3/4" HEIGHT. FOR 1/2 HEIGHT MODESTY USE -2

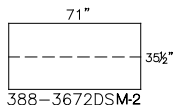
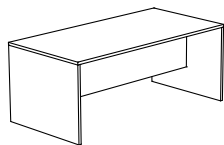

RTA

|               |         |         |     |     |       |      |    |      |
|---------------|---------|---------|-----|-----|-------|------|----|------|
| 388-3060DSM-3 | \$834   | \$951   | 167 | 4.5 | 59.25 | 29.5 | 29 | 29.5 |
| 388-3066DSM-3 | \$868   | \$990   | 172 | 5   | 65    | 29.5 | 29 | 29.5 |
| 388-3072DSM-3 | \$933   | \$1,064 | 177 | 5.5 | 71    | 29.5 | 29 | 29.5 |
| 388-3672DSM-3 | \$1,131 | \$1,289 | 182 | 6   | 71    | 35.5 | 29 | 29.5 |
| 388-3684DSM-3 | \$1,338 | \$1,525 | 207 | 7   | 82.75 | 35.5 | 29 | 29.5 |

- MODESTY PANEL CAN BE TWO-TONED AT NO EXTRA CHARGE

### BOW TOP DESK SHELL W/ EXTENDED PEDESTALS

BOWED MODESTY

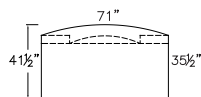
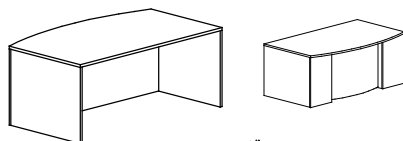

RTA

|              |         |         |     |      |    |      |    |      |
|--------------|---------|---------|-----|------|----|------|----|------|
| 388-MB4272DS | \$1,731 | \$1,973 | 180 | 10.5 | 71 | 41.5 | 29 | 29.5 |
|--------------|---------|---------|-----|------|----|------|----|------|

- BOWED MODESTY PANELS USE HIGH PRESSURE LAMINATE WHICH MAY NOT BE A PERFECT MATCH TO STANDARD LAMINATE
- SEE AVAILABLE HIGH PRESSURE LAMINATE UNDER FINISHES AT [www.heartwood.ca](http://www.heartwood.ca)

### BOW TOP DESK SHELL W/ EXTENDED PEDESTALS

FLAT MP

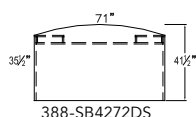
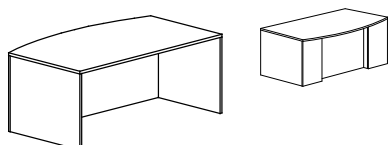

RTA

|              |          |          |     |     |       |      |    |      |
|--------------|----------|----------|-----|-----|-------|------|----|------|
| 388-SB3672DS | \$1,400  | \$1,596  | 195 | 8.5 | 71    | 35.5 | 29 | 29.5 |
| 388-SB3678DS | \$1,427* | \$1,627  | 219 | 7.5 | 77    | 35.5 | 29 | 29.5 |
| 388-SB3684DS | \$1,470* | \$1,676  | 229 | 8   | 82.75 | 35.5 | 29 | 29.5 |
| 388-SB3690DS | \$1,622* | \$1,849* | 244 | 9   | 88.75 | 35.5 | 29 | 29.5 |
| 388-SB3696DS | \$1,776* | \$2,025* | 259 | 11  | 94.5  | 35.5 | 29 | 29.5 |

|              |          |          |       |     |       |      |    |      |
|--------------|----------|----------|-------|-----|-------|------|----|------|
| 388-SB4272DS | \$1,513  | \$1,725  | 205.0 | 9   | 71    | 41.5 | 29 | 29.5 |
| 388-SB4278DS | \$1,557* | \$1,775  | 234   | 8.5 | 77    | 41.5 | 29 | 29.5 |
| 388-SB4284DS | \$1,582* | \$1,803  | 244   | 8.5 | 82.75 | 41.5 | 29 | 29.5 |
| 388-SB4290DS | \$1,738* | \$1,981* | 259   | 9.5 | 88.75 | 41.5 | 29 | 29.5 |
| 388-SB4296DS | \$1,900* | \$2,166* | 274   | 12  | 94.5  | 41.5 | 29 | 29.5 |

- \*UNSUPPORTED UNITS OVER 72" (388) OR OVER 84" (600) REQUIRE CENTER SUPPORT GABLE. ADD +C TO SKU & UPCHARGE OF \$198
- FOR A STRAIGHT FRONT DESK SHELL W/ EXTENDED PEDESTALS REMOVE THE "B" FROM THE SKU AND DECREASE PRICE BY \$100.  
**ORDERING EXAMPLE:** 388-S3672DS

### BOW TOP DESK SHELL W/ EXTENDED PEDESTALS

GLAZED MP

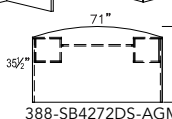
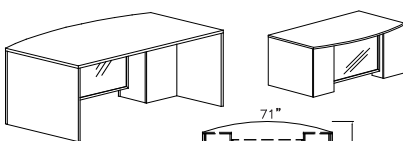

RTA

|                  |         |         |     |    |    |      |    |      |
|------------------|---------|---------|-----|----|----|------|----|------|
| 388-SB3672DS-AGM | \$2,074 | \$2,364 | 190 | 9  | 71 | 35.5 | 29 | 29.5 |
| 388-SB4272DS-AGM | \$2,116 | \$2,412 | 200 | 10 | 71 | 41.5 | 29 | 29.5 |

- GLAZED MODESTY PANELS AVAILABLE IN CLEAR (CL), FROSTED (FR) OR BRONZE (BR) FINISH.
- FOR A STRAIGHT FRONT DESK SHELL W/ EXTENDED PEDESTALS REMOVE THE "B" FROM THE SKU AND DECREASE PRICE BY \$100.  
**ORDERING EXAMPLE:** 388-S3672DS-AGM

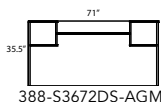
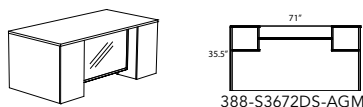

|       | 388  | 600  |        |                 |    |    | 388 | 600 |
|-------|------|------|--------|-----------------|----|----|-----|-----|
| MODEL | LIST | LIST | WEIGHT | CUBE            | W  | D  | H   | H   |
|       | 1"   | 1½"  | LBS    | FT <sup>3</sup> | IN | IN | 1"  | 1½" |

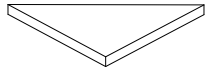

**ANGLE FILLER**

12" X 12" X 17" ANGLED FILLER. INCLUDES BRACKETS

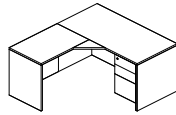
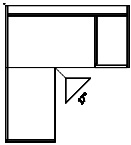

|                    |              |              |          |            |           |           |          |            |
|--------------------|--------------|--------------|----------|------------|-----------|-----------|----------|------------|
| <b>388-1217AFI</b> | <b>\$230</b> | <b>\$262</b> | <b>4</b> | <b>0.2</b> | <b>12</b> | <b>12</b> | <b>1</b> | <b>1.5</b> |
|--------------------|--------------|--------------|----------|------------|-----------|-----------|----------|------------|

- USED TO CREATE 45 ANGLE

**BRIDGE RETURN**

20" DEEP

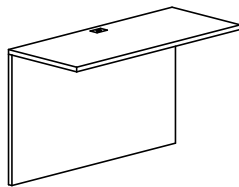

|                   |              |              |           |            |             |              |           |             |
|-------------------|--------------|--------------|-----------|------------|-------------|--------------|-----------|-------------|
| <b>388-2042BR</b> | <b>\$454</b> | <b>\$518</b> | <b>56</b> | <b>1.8</b> | <b>41.5</b> | <b>19.75</b> | <b>29</b> | <b>29.5</b> |
|-------------------|--------------|--------------|-----------|------------|-------------|--------------|-----------|-------------|

|                   |              |              |           |          |              |              |           |             |
|-------------------|--------------|--------------|-----------|----------|--------------|--------------|-----------|-------------|
| <b>388-2048BR</b> | <b>\$471</b> | <b>\$537</b> | <b>63</b> | <b>2</b> | <b>47.25</b> | <b>19.75</b> | <b>29</b> | <b>29.5</b> |
|-------------------|--------------|--------------|-----------|----------|--------------|--------------|-----------|-------------|

24" DEEP

|                   |              |              |           |          |             |              |           |             |
|-------------------|--------------|--------------|-----------|----------|-------------|--------------|-----------|-------------|
| <b>388-2430BR</b> | <b>\$488</b> | <b>\$556</b> | <b>44</b> | <b>2</b> | <b>29.5</b> | <b>23.75</b> | <b>29</b> | <b>29.5</b> |
|-------------------|--------------|--------------|-----------|----------|-------------|--------------|-----------|-------------|

|                   |              |              |           |            |             |              |           |             |
|-------------------|--------------|--------------|-----------|------------|-------------|--------------|-----------|-------------|
| <b>388-2436BR</b> | <b>\$543</b> | <b>\$619</b> | <b>52</b> | <b>1.5</b> | <b>35.5</b> | <b>23.75</b> | <b>29</b> | <b>29.5</b> |
|-------------------|--------------|--------------|-----------|------------|-------------|--------------|-----------|-------------|

|                   |              |              |           |            |             |              |           |             |
|-------------------|--------------|--------------|-----------|------------|-------------|--------------|-----------|-------------|
| <b>388-2442BR</b> | <b>\$576</b> | <b>\$657</b> | <b>61</b> | <b>1.8</b> | <b>41.5</b> | <b>23.75</b> | <b>29</b> | <b>29.5</b> |
|-------------------|--------------|--------------|-----------|------------|-------------|--------------|-----------|-------------|

|                   |              |              |           |          |              |              |           |             |
|-------------------|--------------|--------------|-----------|----------|--------------|--------------|-----------|-------------|
| <b>388-2448BR</b> | <b>\$583</b> | <b>\$665</b> | <b>70</b> | <b>2</b> | <b>47.25</b> | <b>23.75</b> | <b>29</b> | <b>29.5</b> |
|-------------------|--------------|--------------|-----------|----------|--------------|--------------|-----------|-------------|

**RTA**

- ONE CENTERED GROMMET. INDICATE ON PO IF GROMMET IS NOT REQUIRED, NO EXTRA CHARGE.

**PEDESTAL RETURNS**

**RETURN RIGHT**

BOX/BOX/FILE. ALL DRAWERS LOCK.

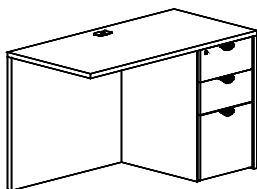

|                   |                |                |           |           |             |              |           |             |
|-------------------|----------------|----------------|-----------|-----------|-------------|--------------|-----------|-------------|
| <b>388-2042UF</b> | <b>\$1,132</b> | <b>\$1,290</b> | <b>97</b> | <b>16</b> | <b>41.5</b> | <b>19.75</b> | <b>29</b> | <b>29.5</b> |
|-------------------|----------------|----------------|-----------|-----------|-------------|--------------|-----------|-------------|

|                   |                |                |            |           |              |              |           |             |
|-------------------|----------------|----------------|------------|-----------|--------------|--------------|-----------|-------------|
| <b>388-2048UF</b> | <b>\$1,145</b> | <b>\$1,305</b> | <b>115</b> | <b>19</b> | <b>47.25</b> | <b>19.75</b> | <b>29</b> | <b>29.5</b> |
|-------------------|----------------|----------------|------------|-----------|--------------|--------------|-----------|-------------|

|                   |                |                |            |           |             |              |           |             |
|-------------------|----------------|----------------|------------|-----------|-------------|--------------|-----------|-------------|
| <b>388-2442UF</b> | <b>\$1,203</b> | <b>\$1,371</b> | <b>105</b> | <b>20</b> | <b>41.5</b> | <b>23.75</b> | <b>29</b> | <b>29.5</b> |
|-------------------|----------------|----------------|------------|-----------|-------------|--------------|-----------|-------------|

|                   |                |                |            |           |              |              |           |             |
|-------------------|----------------|----------------|------------|-----------|--------------|--------------|-----------|-------------|
| <b>388-2448UF</b> | <b>\$1,212</b> | <b>\$1,382</b> | <b>135</b> | <b>22</b> | <b>47.25</b> | <b>23.75</b> | <b>29</b> | <b>29.5</b> |
|-------------------|----------------|----------------|------------|-----------|--------------|--------------|-----------|-------------|

**RETURN LEFT**

BOX/BOX/FILE. ALL DRAWERS LOCK.

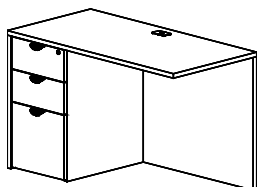

|                   |                |                |           |           |             |              |           |             |
|-------------------|----------------|----------------|-----------|-----------|-------------|--------------|-----------|-------------|
| <b>388-UF2042</b> | <b>\$1,132</b> | <b>\$1,290</b> | <b>97</b> | <b>16</b> | <b>41.5</b> | <b>19.75</b> | <b>29</b> | <b>29.5</b> |
|-------------------|----------------|----------------|-----------|-----------|-------------|--------------|-----------|-------------|

|                   |                |                |            |           |              |              |           |             |
|-------------------|----------------|----------------|------------|-----------|--------------|--------------|-----------|-------------|
| <b>388-UF2048</b> | <b>\$1,145</b> | <b>\$1,305</b> | <b>115</b> | <b>19</b> | <b>47.25</b> | <b>19.75</b> | <b>29</b> | <b>29.5</b> |
|-------------------|----------------|----------------|------------|-----------|--------------|--------------|-----------|-------------|

|                   |                |                |            |           |             |              |           |             |
|-------------------|----------------|----------------|------------|-----------|-------------|--------------|-----------|-------------|
| <b>388-UF2442</b> | <b>\$1,203</b> | <b>\$1,371</b> | <b>105</b> | <b>20</b> | <b>41.5</b> | <b>23.75</b> | <b>29</b> | <b>29.5</b> |
|-------------------|----------------|----------------|------------|-----------|-------------|--------------|-----------|-------------|

|                   |                |                |            |           |              |              |           |             |
|-------------------|----------------|----------------|------------|-----------|--------------|--------------|-----------|-------------|
| <b>388-UF2448</b> | <b>\$1,212</b> | <b>\$1,382</b> | <b>135</b> | <b>22</b> | <b>47.25</b> | <b>23.75</b> | <b>29</b> | <b>29.5</b> |
|-------------------|----------------|----------------|------------|-----------|--------------|--------------|-----------|-------------|

- ONE CENTERED GROMMET. INDICATE ON PO IF GROMMET IS NOT REQUIRED, NO EXTRA CHARGE.

## 388/600 RETURNS PEDESTAL RETURNS

|       | 388  | 600  |        |                 |    |    | 388 | 600 |
|-------|------|------|--------|-----------------|----|----|-----|-----|
| MODEL | LIST | LIST | WEIGHT | CUBE            | W  | D  | H   | H   |
|       | 1"   | 1½"  | LBS    | FT <sup>3</sup> | IN | IN | 1"  | 1½" |

### RETURN RIGHT

BOX/FILE. BOTH DRAWERS LOCK.

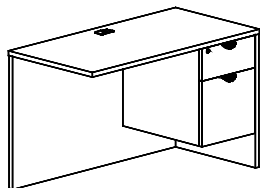

|           |       |         |     |    |       |       |    |      |
|-----------|-------|---------|-----|----|-------|-------|----|------|
| 388-2042F | \$901 | \$1,027 | 82  | 16 | 41.5  | 19.75 | 29 | 29.5 |
| 388-2048F | \$904 | \$1,031 | 100 | 19 | 47.25 | 19.75 | 29 | 29.5 |
| 388-2442F | \$955 | \$1,089 | 90  | 20 | 41.5  | 23.75 | 29 | 29.5 |
| 388-2448F | \$965 | \$1,100 | 120 | 22 | 47.25 | 23.75 | 29 | 29.5 |

- ONE CENTERED GROMMET. INDICATE ON PO IF GROMMET **IS NOT** REQUIRED, NO EXTRA CHARGE.

### RETURN LEFT

BOX/FILE. BOTH DRAWERS LOCK.

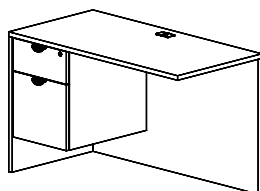

|           |       |         |     |    |       |       |    |      |
|-----------|-------|---------|-----|----|-------|-------|----|------|
| 388-F2042 | \$901 | \$1,027 | 82  | 16 | 41.5  | 19.75 | 29 | 29.5 |
| 388-F2048 | \$904 | \$1,031 | 100 | 19 | 47.25 | 19.75 | 29 | 29.5 |
| 388-F2442 | \$955 | \$1,089 | 90  | 20 | 41.5  | 23.75 | 29 | 29.5 |
| 388-F2448 | \$965 | \$1,100 | 120 | 22 | 47.25 | 23.75 | 29 | 29.5 |

- ONE CENTERED GROMMET. INDICATE ON PO IF GROMMET **IS NOT** REQUIRED, NO EXTRA CHARGE.

## RETURN SHELLS

### NON HANDED RETURN SHELL

20" DEEP CAN BE ASSEMBLED LEFT OR RIGHT.

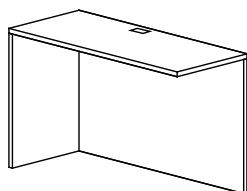

|            |       |       |    |   |       |       |    |      |
|------------|-------|-------|----|---|-------|-------|----|------|
| 388-2030RS | \$551 | \$628 | 50 | 2 | 29.5  | 19.75 | 29 | 29.5 |
| 388-2036RS | \$566 | \$645 | 57 | 2 | 35.5  | 19.75 | 29 | 29.5 |
| 388-2042RS | \$594 | \$677 | 63 | 2 | 41.5  | 19.75 | 29 | 29.5 |
| 388-2048RS | \$606 | \$691 | 69 | 2 | 47.25 | 19.75 | 29 | 29.5 |

24" DEEP CAN BE ASSEMBLED LEFT OR RIGHT.

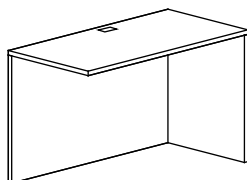

|            |       |       |    |   |       |       |    |      |
|------------|-------|-------|----|---|-------|-------|----|------|
| 388-2430RS | \$576 | \$657 | 50 | 2 | 29.5  | 23.75 | 29 | 29.5 |
| 388-2436RS | \$598 | \$682 | 57 | 2 | 35.5  | 23.75 | 29 | 29.5 |
| 388-2442RS | \$639 | \$728 | 63 | 2 | 41.5  | 23.75 | 29 | 29.5 |
| 388-2448RS | \$655 | \$747 | 69 | 2 | 47.25 | 23.75 | 29 | 29.5 |

- ONE CENTERED GROMMET. INDICATE ON PO IF GROMMET **IS NOT** REQUIRED, NO EXTRA CHARGE.

RTA

| MODEL | 388  | 600  | WEIGHT | CUBE | W | D | 388 | 600 |
|-------|------|------|--------|------|---|---|-----|-----|
|       | LIST | LIST |        |      |   |   | H   | H   |
|       | 1"   | 1½"  |        |      |   |   | 1"  | 1½" |

**24" CONNECTOR TOP**

W/ FLUSH, FULL MODESTY PANEL. GABLE SETS ARE **NON HANDED**.

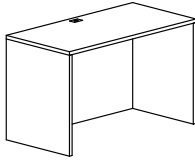

GABLE SET 'A'

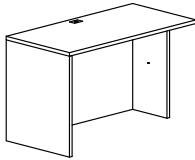

GABLE SET 'B'

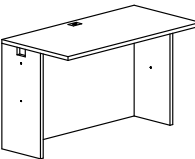

GABLE SET 'C'

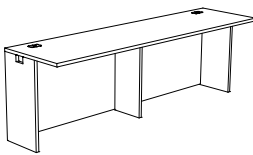

388-2490CT-C+C

**RTA**

|            |          |          |     |     |       |       |    |      |
|------------|----------|----------|-----|-----|-------|-------|----|------|
| 388-2424CT | \$577    | \$658    | 60  | 1.6 | 23.75 | 23.75 | 29 | 29.5 |
| 388-2430CT | \$577    | \$658    | 63  | 2   | 29.5  | 23.75 | 29 | 29.5 |
| 388-2436CT | \$615    | \$701    | 68  | 2   | 35.5  | 23.75 | 29 | 29.5 |
| 388-2442CT | \$638    | \$727    | 74  | 2.2 | 41.5  | 23.75 | 29 | 29.5 |
| 388-2448CT | \$672    | \$766    | 80  | 2.5 | 47.25 | 23.75 | 29 | 29.5 |
| 388-2454CT | \$697    | \$795    | 86  | 2.8 | 53.25 | 23.75 | 29 | 29.5 |
| 388-2460CT | \$716    | \$816    | 92  | 3.1 | 59.25 | 23.75 | 29 | 29.5 |
| 388-2466CT | \$758    | \$864    | 103 | 3.4 | 65    | 23.75 | 29 | 29.5 |
| 388-2472CT | \$801    | \$913    | 115 | 3.7 | 71    | 23.75 | 29 | 29.5 |
| 388-2478CT | \$946*   | \$1,078  | 140 | 4   | 77    | 23.75 | 29 | 29.5 |
| 388-2484CT | \$1,044* | \$1,190  | 154 | 4.5 | 82.75 | 23.75 | 29 | 29.5 |
| 388-2490CT | \$1,138* | \$1,297* | 170 | 5   | 88.75 | 23.75 | 29 | 29.5 |
| 388-2496CT | \$1,244* | \$1,418* | 190 | 5.5 | 94.5  | 23.75 | 29 | 29.5 |

- \*UNSUPPORTED UNITS OVER 72" (388) OR OVER 84" (600) REQUIRE CENTER SUPPORT GABLE. ADD +C TO SKU & UPCHARGE OF **\$198**
- MUST BE ORDERED WITH A, B OR C GABLE SET (REFER IMAGES) - ADD LETTER TO MODEL NUMBER - **EXAMPLE:** 388-2448CT-**A**
- TO ORDER WITH 2.5" RECESSED, MODESTY PANEL - ADD '**R**' TO MODEL NUMBER - **EXAMPLE:** 388-**R**2448CT-A
- TO ORDER WITH ½ OR ¾ MODESTY PANEL - ADD '**2**' (½) OR '**3**' (¾) TO MODEL NUMBER - **EXAMPLE:** 388-2448CT-**A2**
- 20" DEEP CONNECTORS AVAILABLE. USE 24" DEEP PRICING
- ONE CENTERED GROMMET. INDICATE ON PO IF GROMMET **IS NOT** REQUIRED, NO EXTRA CHARGE.

**CUTBACK CONNECTOR TOPS - 24"**

**24" RIGHT CONNECTOR, CUTBACK LEFT**

W/ FLUSH, FULL MODESTY PANEL.

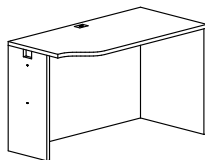

GABLE SET 'B'

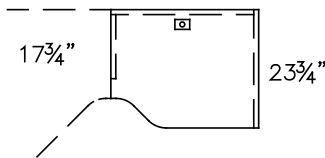

|               |       |       |     |     |       |       |    |      |
|---------------|-------|-------|-----|-----|-------|-------|----|------|
| 388-2430RC-CL | \$612 | \$698 | 63  | 1.6 | 29.5  | 23.75 | 29 | 29.5 |
| 388-2436RC-CL | \$646 | \$736 | 68  | 2   | 35.5  | 23.75 | 29 | 29.5 |
| 388-2442RC-CL | \$672 | \$766 | 74  | 2.2 | 41.5  | 23.75 | 29 | 29.5 |
| 388-2448RC-CL | \$702 | \$800 | 80  | 2.5 | 47.25 | 23.75 | 29 | 29.5 |
| 388-2454RC-CL | \$730 | \$832 | 86  | 2.8 | 53.25 | 23.75 | 29 | 29.5 |
| 388-2460RC-CL | \$745 | \$849 | 92  | 3.1 | 59.25 | 23.75 | 29 | 29.5 |
| 388-2466RC-CL | \$789 | \$899 | 103 | 3.4 | 65    | 23.75 | 29 | 29.5 |
| 388-2472RC-CL | \$832 | \$948 | 115 | 3.7 | 71    | 23.75 | 29 | 29.5 |

- RC-CL'S OR LC-CR'S - MUST BE ORDERED WITH B OR C GABLE SET - ADD LETTER TO MODEL NUMBER - **EXAMPLE:** 388-2448RC-CL-**B**
- TO ORDER WITH 2.5" RECESSED, MODESTY PANEL - ADD '**R**' TO MODEL NUMBER - **EXAMPLE:** 388-**R**2448RC-CL-B
- TO ORDER WITH ½ OR ¾ MODESTY PANEL - ADD '**2**' (½) OR '**3**' (¾) TO MODEL NUMBER - **EXAMPLE:** 388-2448RC-CL-**B2**
- ONE CENTERED GROMMET. INDICATE ON PO IF GROMMET **IS NOT** REQUIRED, NO EXTRA CHARGE.

**RTA**

# 388/600 CONNECTOR TOPS

## CUTBACK CONNECTOR TOPS - 24"

| MODEL | 388  | 600  | WEIGHT | CUBE            | W  | D  | 388 | 600 |
|-------|------|------|--------|-----------------|----|----|-----|-----|
|       | LIST | LIST |        |                 |    |    | H   | H   |
|       | 1"   | 1½"  | LBS    | FT <sup>3</sup> | IN | IN | 1"  | 1½" |

### 24" LEFT CONNECTOR, CUTBACK RIGHT

W/ FLUSH, FULL MODESTY PANEL.

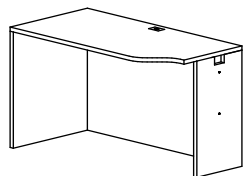

GABLE SET 'B'

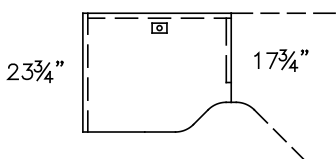

|               |       |       |     |     |       |       |    |      |
|---------------|-------|-------|-----|-----|-------|-------|----|------|
| 388-2430LC-CR | \$612 | \$698 | 63  | 1.6 | 29.5  | 23.75 | 29 | 29.5 |
| 388-2436LC-CR | \$646 | \$736 | 68  | 2   | 35.5  | 23.75 | 29 | 29.5 |
| 388-2442LC-CR | \$672 | \$766 | 74  | 2.2 | 41.5  | 23.75 | 29 | 29.5 |
| 388-2448LC-CR | \$702 | \$800 | 80  | 2.5 | 47.25 | 23.75 | 29 | 29.5 |
| 388-2454LC-CR | \$730 | \$832 | 86  | 2.8 | 53.25 | 23.75 | 29 | 29.5 |
| 388-2460LC-CR | \$745 | \$849 | 92  | 3.1 | 59.25 | 23.75 | 29 | 29.5 |
| 388-2466LC-CR | \$789 | \$899 | 103 | 3.4 | 65    | 23.75 | 29 | 29.5 |
| 388-2472LC-CR | \$832 | \$948 | 115 | 3.7 | 71    | 23.75 | 29 | 29.5 |

\*JOIN W/ 1836CM

- RC-CL'S OR LC-CR'S - MUST BE ORDERED WITH B OR C GABLE SET - ADD LETTER TO MODEL NUMBER - **EXAMPLE:** 388-2448LC-CR-**B**
- TO ORDER WITH 2.5" RECESSED, MODESTY PANEL - ADD 'R' TO MODEL NUMBER - **EXAMPLE:** 388-**R**2448LC-CR-B
- TO ORDER WITH ½ OR ¾ MODESTY PANEL - ADD '2' (½) OR '3' (¾) TO MODEL NUMBER - **EXAMPLE:** 388-2448LC-CR-**B2**
- ONE CENTERED GROMMET. INDICATE ON PO IF GROMMET **IS NOT** REQUIRED, NO EXTRA CHARGE.

RTA

### 24" CENTER CONNECTOR, CUTBACK DOUBLE

W/ FLUSH, FULL MODESTY PANEL.

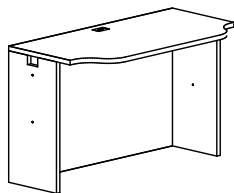

GABLE SET 'C'

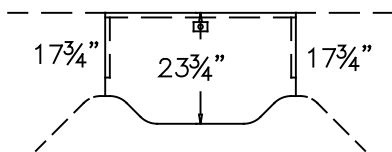

|               |       |       |     |     |       |       |    |      |
|---------------|-------|-------|-----|-----|-------|-------|----|------|
| 388-2430CC-CD | \$644 | \$734 | 63  | 1.6 | 29.5  | 23.75 | 29 | 29.5 |
| 388-2436CC-CD | \$661 | \$754 | 68  | 2   | 35.5  | 23.75 | 29 | 29.5 |
| 388-2442CC-CD | \$689 | \$785 | 74  | 2.2 | 41.5  | 23.75 | 29 | 29.5 |
| 388-2448CC-CD | \$720 | \$821 | 80  | 2.5 | 47.25 | 23.75 | 29 | 29.5 |
| 388-2454CC-CD | \$762 | \$869 | 86  | 2.8 | 53.25 | 23.75 | 29 | 29.5 |
| 388-2460CC-CD | \$771 | \$879 | 92  | 3.1 | 59.25 | 23.75 | 29 | 29.5 |
| 388-2466CC-CD | \$815 | \$929 | 103 | 3.4 | 65    | 23.75 | 29 | 29.5 |
| 388-2472CC-CD | \$852 | \$971 | 115 | 3.7 | 71    | 23.75 | 29 | 29.5 |

- MUST BE ORDERED WITH DEFAULT C GABLE SET - ADD LETTER TO MODEL NUMBER - **EXAMPLE:** 388-2448CC-CD-**C**
- TO ORDER WITH 2.5" RECESSED, MODESTY PANEL - ADD 'R' TO MODEL NUMBER - **EXAMPLE:** 388-**R**2448CC-CD-C
- TO ORDER WITH ½ OR ¾ MODESTY PANEL - ADD '2' (½) OR '3' (¾) TO MODEL NUMBER - **EXAMPLE:** 388-2448CC-CD-**C2**
- ONE CENTERED GROMMET. INDICATE ON PO IF GROMMET **IS NOT** REQUIRED, NO EXTRA CHARGE.

RTA



| MODEL | 388  | 600  | WEIGHT | CUBE | W | D | 388 | 600 |
|-------|------|------|--------|------|---|---|-----|-----|
|       | LIST | LIST |        |      |   |   | H   | H   |
|       | 1"   | 1½"  |        |      |   |   | 1"  | 1½" |

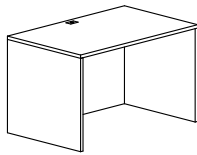

GABLE SET 'A'

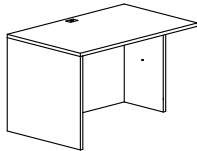

GABLE SET 'B'

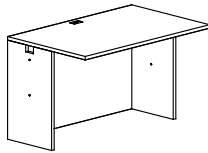

GABLE SET 'C'

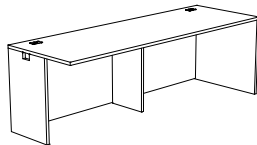

388-3090CT-B+C

**RTA**

**30" CONNECTOR TOP**

W/ FLUSH, FULL MODESTY PANEL. GABLE SETS ARE **NON HANDED**.

|            |          |          |     |     |       |      |    |      |
|------------|----------|----------|-----|-----|-------|------|----|------|
| 388-3030CT | \$646    | \$736    | 78  | 1.8 | 29.5  | 29.5 | 29 | 29.5 |
| 388-3036CT | \$683    | \$779    | 84  | 2.1 | 35.5  | 29.5 | 29 | 29.5 |
| 388-3042CT | \$711    | \$811    | 91  | 2.8 | 41.5  | 29.5 | 29 | 29.5 |
| 388-3048CT | \$734    | \$837    | 97  | 3.6 | 47.25 | 29.5 | 29 | 29.5 |
| 388-3054CT | \$781    | \$890    | 103 | 4   | 53.25 | 29.5 | 29 | 29.5 |
| 388-3060CT | \$803    | \$915    | 110 | 4.2 | 59.25 | 29.5 | 29 | 29.5 |
| 388-3066CT | \$837    | \$954    | 124 | 4.7 | 65    | 29.5 | 29 | 29.5 |
| 388-3072CT | \$879    | \$1,002  | 140 | 5.2 | 71    | 29.5 | 29 | 29.5 |
| 388-3078CT | \$993*   | \$1,132  | 159 | 6.5 | 77    | 29.5 | 29 | 29.5 |
| 388-3084CT | \$1,118* | \$1,275  | 173 | 7.5 | 82.75 | 29.5 | 29 | 29.5 |
| 388-3090CT | \$1,244* | \$1,418* | 190 | 8   | 88.75 | 29.5 | 29 | 29.5 |
| 388-3096CT | \$1,352* | \$1,541* | 209 | 8.5 | 94.5  | 29.5 | 29 | 29.5 |

- MUST BE ORDERED WITH A, B OR C GABLE SET - ADD LETTER TO MODEL NUMBER - **EXAMPLE:** 388-R3048CT-**A**
- TO ORDER WITH 2.5" RECESSED, MODESTY PANEL - ADD 'R' TO MODEL NUMBER - **EXAMPLE:** 388-**R**3048CT-A
- TO ORDER WITH ½ OR ¾ MODESTY PANEL - ADD '2' (½) OR '3' (¾) TO MODEL NUMBER - **EXAMPLE:** 388-3048CT-A**2**
- ONE CENTERED GROMMET. INDICATE ON PO IF GROMMET **IS NOT** REQUIRED, NO EXTRA CHARGE. 30" DEEP CONNECTORS OVER 54" WIDE RECEIVE 2 GROMMETS
- \*UNSUPPORTED UNITS OVER 72" (388) OR OVER 84" (600) REQUIRE CENTER SUPPORT GABLE. ADD **+C** TO SKU & UPCHARGE OF **\$198**

**CUTBACK CONNECTOR TOPS - 30"**

**30" RIGHT CONNECTOR, CUTBACK LEFT**

W/ FLUSH, FULL MODESTY PANEL.

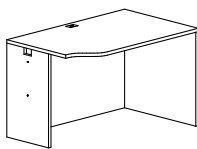

GABLE SET 'B'

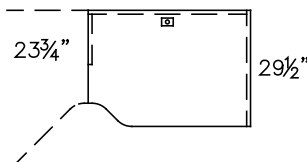

**RTA**

|               |       |         |     |     |       |      |    |      |
|---------------|-------|---------|-----|-----|-------|------|----|------|
| 388-3030RC-CL | \$683 | \$779   | 78  | 1.8 | 29.5  | 29.5 | 29 | 29.5 |
| 388-3036RC-CL | \$717 | \$817   | 84  | 2.1 | 35.5  | 29.5 | 29 | 29.5 |
| 388-3042RC-CL | \$745 | \$849   | 91  | 2.8 | 41.5  | 29.5 | 29 | 29.5 |
| 388-3048RC-CL | \$766 | \$873   | 97  | 3.6 | 47.25 | 29.5 | 29 | 29.5 |
| 388-3054RC-CL | \$814 | \$928   | 103 | 4   | 53.25 | 29.5 | 29 | 29.5 |
| 388-3060RC-CL | \$836 | \$953   | 110 | 4.2 | 59.25 | 29.5 | 29 | 29.5 |
| 388-3066RC-CL | \$869 | \$991   | 124 | 4.7 | 65    | 29.5 | 29 | 29.5 |
| 388-3072RC-CL | \$911 | \$1,039 | 140 | 5.2 | 71    | 29.5 | 29 | 29.5 |

**\*JOIN W/ 2436CM / 2442CM**

- RC-CL'S OR LC-CR'S - MUST BE ORDERED WITH B OR C GABLE SET - ADD LETTER TO MODEL NUMBER - **EXAMPLE:** 388-3048RC-CL-**B**
- TO ORDER WITH 2.5" RECESSED, MODESTY PANEL - ADD 'R' TO MODEL NUMBER - **EXAMPLE:** 388-**R**3048RC-CL-B
- TO ORDER WITH ½ OR ¾ MODESTY PANEL - ADD '2' (½) OR '3' (¾) TO MODEL NUMBER - **EXAMPLE:** 388-3048RC-CL-B**2**
- ONE CENTERED GROMMET. INDICATE ON PO IF GROMMET **IS NOT** REQUIRED, NO EXTRA CHARGE. 30" DEEP CONNECTORS OVER 54" WIDE RECEIVE 2 GROMMETS

# 388/600 CONNECTOR TOPS

## CUTBACK CONNECTOR TOPS - 30"

|       | 388  | 600  |        |                 |    |    | 388 | 600 |
|-------|------|------|--------|-----------------|----|----|-----|-----|
| MODEL | LIST | LIST | WEIGHT | CUBE            | W  | D  | H   | H   |
|       | 1"   | 1½"  | LBS    | FT <sup>3</sup> | IN | IN | 1"  | 1½" |

### 30" LEFT CONNECTOR, CUTBACK RIGHT

W/ FLUSH, FULL MODESTY PANEL.

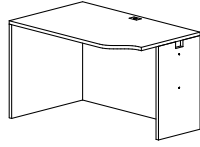

GABLE SET 'B'

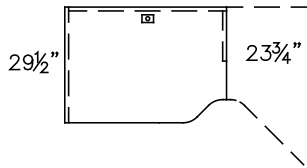

|               |       |         |     |     |       |      |    |      |
|---------------|-------|---------|-----|-----|-------|------|----|------|
| 388-3030LC-CR | \$683 | \$779   | 78  | 1.8 | 29.5  | 29.5 | 29 | 29.5 |
| 388-3036LC-CR | \$717 | \$817   | 84  | 2.1 | 35.5  | 29.5 | 29 | 29.5 |
| 388-3042LC-CR | \$745 | \$849   | 91  | 2.8 | 41.5  | 29.5 | 29 | 29.5 |
| 388-3048LC-CR | \$766 | \$873   | 97  | 3.6 | 47.25 | 29.5 | 29 | 29.5 |
| 388-3054LC-CR | \$814 | \$928   | 103 | 4   | 53.25 | 29.5 | 29 | 29.5 |
| 388-3060LC-CR | \$836 | \$953   | 110 | 4.2 | 59.25 | 29.5 | 29 | 29.5 |
| 388-3066LC-CR | \$869 | \$991   | 124 | 4.7 | 65    | 29.5 | 29 | 29.5 |
| 388-3072LC-CR | \$911 | \$1,039 | 140 | 5.2 | 71    | 29.5 | 29 | 29.5 |

- RC-CL'S OR LC-CR'S - MUST BE ORDERED WITH B OR C GABLE SET - ADD LETTER TO MODEL NUMBER - **EXAMPLE:** 388-3048LC-CR-**B**
- TO ORDER WITH 2.5" RECESSED, MODESTY PANEL - ADD 'R' TO MODEL NUMBER - **EXAMPLE:** 388-**R**3048LC-CR-B
- TO ORDER WITH ½ OR ¾ MODESTY PANEL - ADD '2' (½) OR '3' (¾) TO MODEL NUMBER - **EXAMPLE:** 388-3048LC-CR-**B2**
- ONE CENTERED GROMMET. INDICATE ON PO IF GROMMET **IS NOT** REQUIRED, NO EXTRA CHARGE. 30" DEEP CONNECTORS OVER 54" WIDE RECEIVE 2 GROMMETS

RTA

### 30" CENTER CONNECTOR, CUTBACK DOUBLE

W/ FLUSH, FULL MODESTY PANEL.

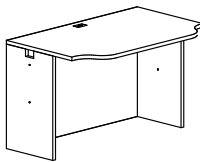

GABLE SET 'C'

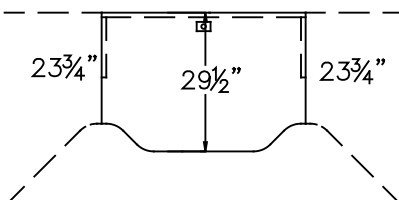

|               |       |         |     |     |       |      |    |      |
|---------------|-------|---------|-----|-----|-------|------|----|------|
| 388-3030CC-CD | \$717 | \$817   | 78  | 1.8 | 29.5  | 29.5 | 29 | 29.5 |
| 388-3036CC-CD | \$749 | \$854   | 84  | 2.1 | 35.5  | 29.5 | 29 | 29.5 |
| 388-3042CC-CD | \$779 | \$888   | 91  | 2.8 | 41.5  | 29.5 | 29 | 29.5 |
| 388-3048CC-CD | \$799 | \$911   | 97  | 3.6 | 47.25 | 29.5 | 29 | 29.5 |
| 388-3054CC-CD | \$840 | \$958   | 103 | 4   | 53.25 | 29.5 | 29 | 29.5 |
| 388-3060CC-CD | \$868 | \$990   | 110 | 4.2 | 59.25 | 29.5 | 29 | 29.5 |
| 388-3066CC-CD | \$900 | \$1,026 | 124 | 4.7 | 65    | 29.5 | 29 | 29.5 |
| 388-3072CC-CD | \$940 | \$1,072 | 140 | 5.2 | 71    | 29.5 | 29 | 29.5 |

- MUST BE ORDERED WITH DEFAULT C GABLE SET - ADD LETTER TO MODEL NUMBER - **EXAMPLE:** 388-3048CC-CD-**C**
- TO ORDER WITH 2.5" RECESSED, MODESTY PANEL - ADD 'R' TO MODEL NUMBER - **EXAMPLE:** 388-**R**3048CC-CD-C
- TO ORDER WITH ½ OR ¾ MODESTY PANEL - ADD '2' (½) OR '3' (¾) TO MODEL NUMBER - **EXAMPLE:** 388-3048CC-CD-**C2**
- ONE CENTERED GROMMET. INDICATE ON PO IF GROMMET **IS NOT** REQUIRED, NO EXTRA CHARGE. 30" DEEP CONNECTORS OVER 54" WIDE RECEIVE 2 GROMMETS

RTA

|       | 388  | 600  |        |                 |    |    |    | 388 | 600 |
|-------|------|------|--------|-----------------|----|----|----|-----|-----|
| MODEL | LIST | LIST | WEIGHT | CUBE            | W  | D  | H  | H   |     |
|       | 1"   | 1½"  | LBS    | FT <sup>3</sup> | IN | IN | 1" | 1½" |     |

**CORNER MODULE**

W/ FLUSH, FULL MODESTY PANEL. GABLE SETS ARE **NON HANDED**.

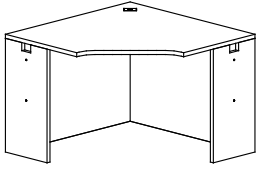

GABLE SET 'C'

|            |         |         |     |     |       |       |    |      |
|------------|---------|---------|-----|-----|-------|-------|----|------|
| 388-1836CM | \$820   | \$935   | 92  | 4.5 | 35.5  | 35.5  | 29 | 29.5 |
| 388-2436CM | \$829   | \$945   | 96  | 4.5 | 35.5  | 35.5  | 29 | 29.5 |
| 388-2442CM | \$973   | \$1,109 | 102 | 5.8 | 41.5  | 41.5  | 29 | 29.5 |
| 388-3042CM | \$979   | \$1,116 | 108 | 6   | 41.5  | 41.5  | 29 | 29.5 |
| 388-3048CM | \$1,037 | \$1,182 | 140 | 7   | 47.25 | 47.25 | 29 | 29.5 |

**USE WITH:**

- 24" BRIDGE (BR)/ RETURN SHELL (RS) OR
- 24" & 30" CONNECTOR TOPS (CT'S) OR
- 24" & 30" CUTBACK CONNECTORS (RC-CL, LC-CR OR CC-CD)

- MUST BE ORDERED WITH A, B OR C GABLE SET- ADD LETTER TO MODEL NUMBER - **EXAMPLE:** 388-2442CM-**C**
- TO ORDER WITH 2.5" RECESSED, MODESTY PANEL - ADD 'R' TO MODEL NUMBER - **EXAMPLE:** 388-~~R~~2442CM-C
- TO ORDER WITH ½ OR ¾ MODESTY PANEL - ADD '2' (½) OR '3' (¾) TO MODEL NUMBER - **EXAMPLE:** 388-2442CM-C**2**
- IF A ½ OR ¾ MODESTY PANEL IS ONLY REQUIRED ON ONE SIDE, CONTACT CUSTOMER SERVICE FOR SKU CODES.

**RTA**

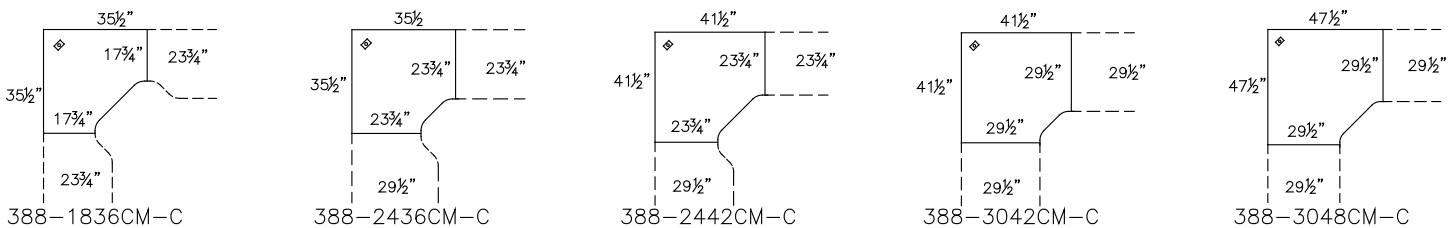

**NEO-ANGLE CORNER MODULES**

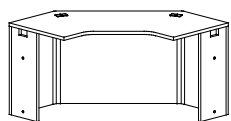

**NEO-ANGLE CORNER MODULE**

|              |         |         |     |   |       |       |    |      |
|--------------|---------|---------|-----|---|-------|-------|----|------|
| 388-2448NACM | \$1,325 | \$1,511 | 120 | 5 | 47.25 | 47.25 | 29 | 29.5 |
| 388-3048NACM | \$1,419 | \$1,702 | 140 | 7 | 47.25 | 47.25 | 29 | 29.5 |

**RTA**

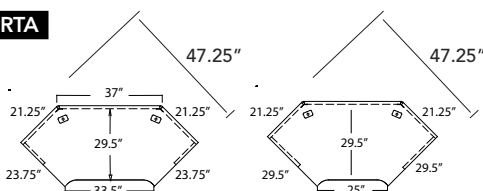

**NOTE:** SEE LAYOUTS PAGE [388/600-108](#) FOR EXAMPLES.

**NEO-ANGLE CORNER WEDGES**

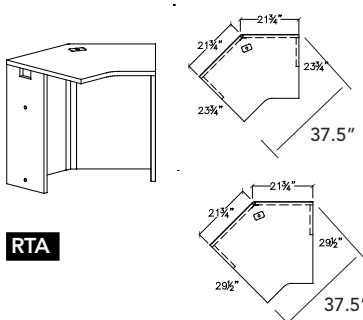

**NEO-ANGLE CORNER WEDGES**

|              |         |         |    |     |    |       |    |      |
|--------------|---------|---------|----|-----|----|-------|----|------|
| 388-2424NACW | \$896   | \$1,021 | 70 | 2.5 | 37 | 23.75 | 29 | 29.5 |
| 388-3030NACW | \$1,059 | \$1,207 | 87 | 3   | 37 | 29.5  | 29 | 29.5 |

**NOTE:** SEE LAYOUTS PAGE [388/600-109](#) FOR EXAMPLES.

# 388/600 CORNER MODULES

## CORNER MODULE DESKS

|       | 388  | 600  |        |                 |    |    | 388 | 600 |
|-------|------|------|--------|-----------------|----|----|-----|-----|
| MODEL | LIST | LIST | WEIGHT | CUBE            | W  | D  | H   | H   |
|       | 1"   | 1½"  | LBS    | FT <sup>3</sup> | IN | IN | 1"  | 1½" |

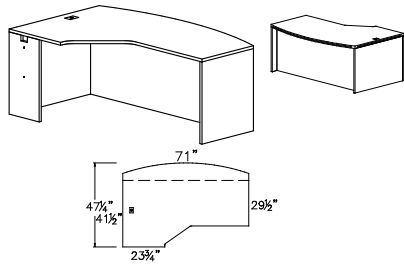

### CORNER MODULE DESK

EXTENDED RIGHT BOW TOP W/ FULL MP, RECESSED 4" AT GABLE.

|                     |                |                |     |   |            |              |           |      |
|---------------------|----------------|----------------|-----|---|------------|--------------|-----------|------|
| <b>388-B4872CMD</b> | <b>\$1,708</b> | <b>\$1,947</b> | 190 | 8 | 23.75 / 71 | 47.25 / 29.5 | <b>29</b> | 29.5 |
|---------------------|----------------|----------------|-----|---|------------|--------------|-----------|------|

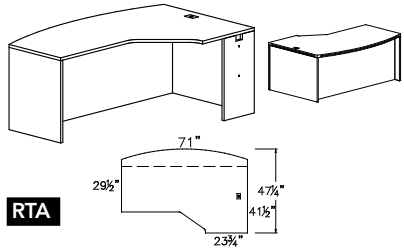

### CORNER MODULE DESK

EXTENDED LEFT BOW TOP W/ FULL MP, RECESSED 4" AT GABLE.

|                     |                |                |     |   |            |              |           |      |
|---------------------|----------------|----------------|-----|---|------------|--------------|-----------|------|
| <b>388-B7248CMD</b> | <b>\$1,708</b> | <b>\$1,947</b> | 190 | 8 | 71 / 23.75 | 29.5 / 47.25 | <b>29</b> | 29.5 |
|---------------------|----------------|----------------|-----|---|------------|--------------|-----------|------|

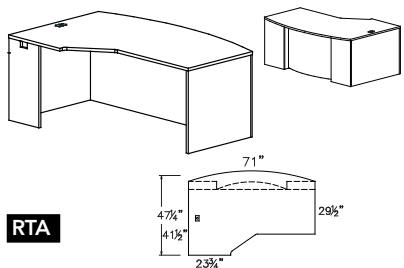

### CORNER MODULE DESK W/ EXTENDED PEDS

EXTENDED RIGHT BOW TOP W/ BOWED MODESTY

|                      |                |                |     |    |            |              |           |      |
|----------------------|----------------|----------------|-----|----|------------|--------------|-----------|------|
| <b>388-MB4872CMD</b> | <b>\$2,172</b> | <b>\$2,476</b> | 210 | 16 | 23.75 / 71 | 47.25 / 29.5 | <b>29</b> | 29.5 |
|----------------------|----------------|----------------|-----|----|------------|--------------|-----------|------|

- BOWED MODESTY PANELS USE HIGH PRESSURE LAMINATE WHICH MAY NOT BE A PERFECT MATCH TO STANDARD LAMINATE.
- SEE AVAILABLE HIGH PRESSURE LAMINATE UNDER FINISHES AT [www.heartwood.ca](http://www.heartwood.ca)

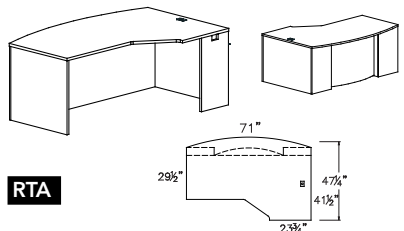

### CORNER MODULE DESK W/ EXTENDED PEDS

EXTENDED LEFT BOW TOP W/ BOWED MODESTY

|                      |                |                |     |    |            |              |           |      |
|----------------------|----------------|----------------|-----|----|------------|--------------|-----------|------|
| <b>388-MB7248CMD</b> | <b>\$2,172</b> | <b>\$2,476</b> | 210 | 16 | 71 / 23.75 | 29.5 / 47.25 | <b>29</b> | 29.5 |
|----------------------|----------------|----------------|-----|----|------------|--------------|-----------|------|

- BOWED MODESTY PANELS USE HIGH PRESSURE LAMINATE WHICH MAY NOT BE A PERFECT MATCH TO STANDARD LAMINATE.
- SEE AVAILABLE HIGH PRESSURE LAMINATE UNDER FINISHES AT [www.heartwood.ca](http://www.heartwood.ca)

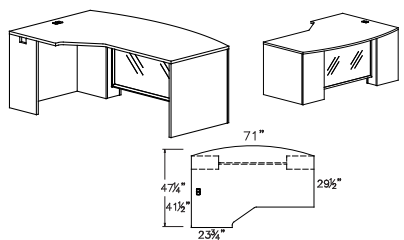

### CORNER MODULE DESK W/ GLAZED MP

EXTENDED RIGHT BOW TOP W/ EXTENDED PEDS AND GLAZED MP

|                          |                |                |     |      |            |              |           |      |
|--------------------------|----------------|----------------|-----|------|------------|--------------|-----------|------|
| <b>388-SB4872CMD-AGM</b> | <b>\$2,471</b> | <b>\$2,817</b> | 230 | 14.5 | 23.75 / 71 | 47.25 / 29.5 | <b>29</b> | 29.5 |
|--------------------------|----------------|----------------|-----|------|------------|--------------|-----------|------|

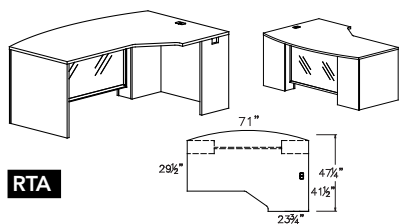

### CORNER MODULE DESK W/ GLAZED MP

EXTENDED LEFT BOW TOP W/ EXTENDED PEDS AND GLAZED MP

|                          |                |                |     |      |            |              |           |      |
|--------------------------|----------------|----------------|-----|------|------------|--------------|-----------|------|
| <b>388-SB7248CMD-AGM</b> | <b>\$2,471</b> | <b>\$2,817</b> | 230 | 14.5 | 23.75 / 71 | 47.25 / 29.5 | <b>29</b> | 29.5 |
|--------------------------|----------------|----------------|-----|------|------------|--------------|-----------|------|

| MODEL | 388  | 600  | WEIGHT | CUBE | W | D | 388 | 600 |
|-------|------|------|--------|------|---|---|-----|-----|
|       | LIST | LIST |        |      |   |   | H   | H   |
|       | 1"   | 1½"  |        |      |   |   | 1"  | 1½" |

**RIGHT EXTENDED CORNER MODULE**

W/ FLUSH, FULL MODESTY PANEL

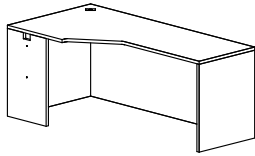

GABLE SET 'B'

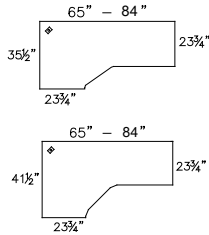

|            |          |         |     |     |            |       |    |      |
|------------|----------|---------|-----|-----|------------|-------|----|------|
| 388-3666CM | \$1,113  | \$1,269 | 145 | 5.5 | 35.5/65    | 23.75 | 29 | 29.5 |
| 388-3672CM | \$1,168  | \$1,332 | 155 | 6   | 35.5/71    | 23.75 | 29 | 29.5 |
| 388-3678CM | \$1,301* | \$1,483 | 165 | 7   | 35.5/77    | 23.75 | 29 | 29.5 |
| 388-3684CM | \$1,532* | \$1,746 | 175 | 7.5 | 35.5/82.75 | 23.75 | 29 | 29.5 |
| 388-4266CM | \$1,352  | \$1,541 | 155 | 6   | 41.5/65    | 23.75 | 29 | 29.5 |
| 388-4272CM | \$1,421  | \$1,620 | 165 | 7   | 41.5/71    | 23.75 | 29 | 29.5 |
| 388-4278CM | \$1,538* | \$1,753 | 175 | 8   | 41.5/77    | 23.75 | 29 | 29.5 |
| 388-4284CM | \$1,700* | \$1,938 | 185 | 9   | 41.5/82.75 | 23.75 | 29 | 29.5 |

- \*UNSUPPORTED UNITS OVER 72" (388) OR OVER 84" (600) REQUIRE CENTER SUPPORT GABLE. ADD +C TO SKU & UPCHARGE OF **\$198**

**LEFT EXTENDED CORNER MODULE**

W/ FLUSH, FULL MODESTY PANEL

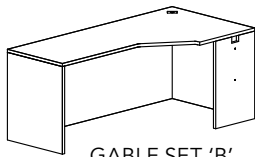

GABLE SET 'B'

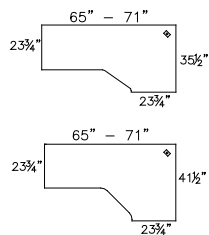

|            |          |         |     |     |            |       |    |      |
|------------|----------|---------|-----|-----|------------|-------|----|------|
| 388-6636CM | \$1,113  | \$1,269 | 145 | 5.5 | 65/35.5    | 23.75 | 29 | 29.5 |
| 388-7236CM | \$1,168  | \$1,332 | 155 | 6   | 71/35.5    | 23.75 | 29 | 29.5 |
| 388-7836CM | \$1,301* | \$1,483 | 165 | 7   | 77/35.5    | 23.75 | 29 | 29.5 |
| 388-8436CM | \$1,532* | \$1,746 | 175 | 7.5 | 82.75/35.5 | 23.75 | 29 | 29.5 |
| 388-6642CM | \$1,352  | \$1,541 | 155 | 6   | 65/41.5    | 23.75 | 29 | 29.5 |
| 388-7242CM | \$1,421  | \$1,620 | 165 | 7   | 71/41.5    | 23.75 | 29 | 29.5 |
| 388-7842CM | \$1,538* | \$1,753 | 175 | 8   | 77/41.5    | 23.75 | 29 | 29.5 |
| 388-8442CM | \$1,700* | \$1,938 | 185 | 9   | 82.75/41.5 | 23.75 | 29 | 29.5 |

- \*UNSUPPORTED UNITS OVER 72" (388) OR OVER 84" (600) REQUIRE CENTER SUPPORT GABLE. ADD +C TO SKU & UPCHARGE OF **\$198**
- MUST BE ORDERED WITH A, B OR C GABLE SET- ADD LETTER TO MODEL NUMBER  
- **EXAMPLE:** 388-7242CM-**C**
- TO ORDER WITH 2.5" RECESSED, MODESTY PANEL - ADD '**R**' TO MODEL NUMBER  
- **EXAMPLE:** 388-**R**7242CM-C
- TO ORDER WITH ½ OR ¾ MODESTY PANEL - ADD '**2**' (½) OR '**3**' (¾) TO MODEL NUMBER  
- **EXAMPLE:** 388-7242CM-C**2**
- IF A ½ OR ¾ MODESTY PANEL IS ONLY REQUIRED ON ONE SIDE, CONTACT CUSTOMER SERVICE FOR SKU CODES.

FOR ALTERNATE CORNER MODULE PROFILES - REFER SPECIFICATIONS & DESCRIPTIONS [388/600-4](#)

**RTA**

# 388/600 CORNER MODULES

## EXTENDED CORNER MODULES

|       | 388  | 600  |        |                 |    |    | 388 | 600 |
|-------|------|------|--------|-----------------|----|----|-----|-----|
| MODEL | LIST | LIST | WEIGHT | CUBE            | W  | D  | H   | H   |
|       | 1"   | 1½"  | LBS    | FT <sup>3</sup> | IN | IN | 1"  | 1½" |

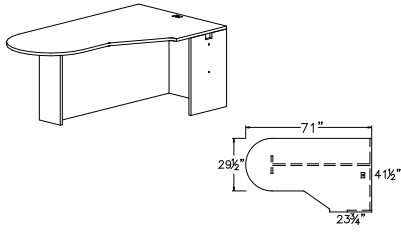

### CORNER MODULE BULLET

LEFT EXTENSION W/ FULL MP & GABLE LEG

|                      |                |                |     |   |              |               |           |      |
|----------------------|----------------|----------------|-----|---|--------------|---------------|-----------|------|
| <b>388-7242CMBTM</b> | <b>\$1,551</b> | <b>\$1,768</b> | 170 | 9 | 71/<br>23.75 | 29.5/<br>41.5 | <b>29</b> | 29.5 |
|----------------------|----------------|----------------|-----|---|--------------|---------------|-----------|------|

- TO ORDER WITH ½ OR ¾ MODESTY PANEL - **ADD '2' (½) OR '3' (¾) TO MODEL NUMBER**  
- **EXAMPLE:** 388-7242CMBTM-2

### CORNER MODULE BULLET

RIGHT EXTENSION W/ FULL MP & GABLE LEG

|                      |                |                |     |   |              |               |           |      |
|----------------------|----------------|----------------|-----|---|--------------|---------------|-----------|------|
| <b>388-4272CMBTM</b> | <b>\$1,551</b> | <b>\$1,768</b> | 170 | 9 | 71/<br>23.75 | 41.5/<br>29.5 | <b>29</b> | 29.5 |
|----------------------|----------------|----------------|-----|---|--------------|---------------|-----------|------|

- TO ORDER WITH ½ OR ¾ MODESTY PANEL - **ADD '2' (½) OR '3' (¾) TO MODEL NUMBER**  
- **EXAMPLE:** 388-4272CMBTM-2
- PENINSULA PRICE BOOK IMAGES SHOWN W/ LAMINATE GABLE LEG CAN HAVE METAL LEGS.  
UPCHARGE WILL BE APPLIED PER LEG SUBSTITUTION OF **\$156**  
SEE PAGE **388/600-24** FOR LEG OPTIONS.

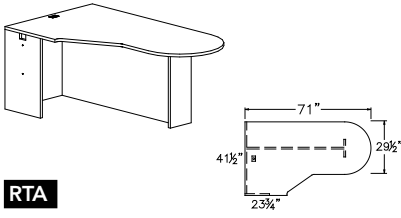

**RTA**

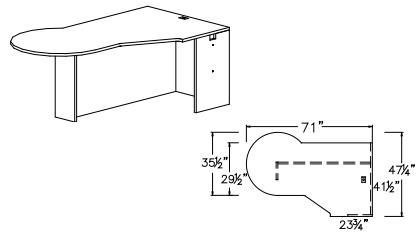

### CORNER MODULE P-TOP

LEFT EXTENSION W/ FULL MP & GABLE LEG

|                      |                |                |     |    |              |                |           |      |
|----------------------|----------------|----------------|-----|----|--------------|----------------|-----------|------|
| <b>388-7242CMPTM</b> | <b>\$1,650</b> | <b>\$1,881</b> | 180 | 10 | 23.75/<br>71 | 35.5/<br>47.25 | <b>29</b> | 29.5 |
|----------------------|----------------|----------------|-----|----|--------------|----------------|-----------|------|

- TO ORDER WITH ½ OR ¾ MODESTY PANEL - **ADD '2' (½) OR '3' (¾) TO MODEL NUMBER**  
**EXAMPLE:** 388-7242CMPTM-2

### CORNER MODULE P-TOP

RIGHT EXTENSION W/ FULL MP & GABLE LEG

|                      |                |                |     |    |              |                |           |      |
|----------------------|----------------|----------------|-----|----|--------------|----------------|-----------|------|
| <b>388-4272CMPTM</b> | <b>\$1,650</b> | <b>\$1,881</b> | 180 | 10 | 71/<br>23.75 | 47.25/<br>29.5 | <b>29</b> | 29.5 |
|----------------------|----------------|----------------|-----|----|--------------|----------------|-----------|------|

- TO ORDER WITH ½ OR ¾ MODESTY PANEL - **ADD '2' (½) OR '3' (¾) TO MODEL NUMBER**  
**EXAMPLE:** 388-4272CMPTM-2

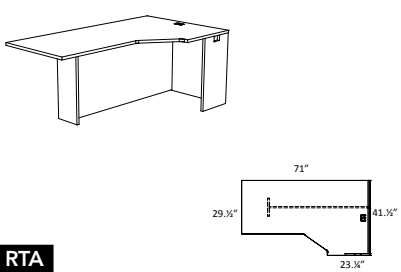
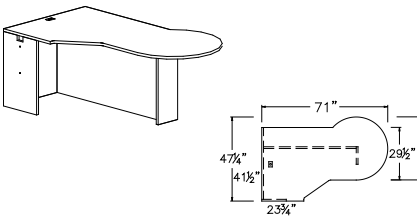

### CORNER MODULE RECTANGULAR BULLET

LEFT EXTENSION W/ FULL MP & GABLE LEG

|                       |                |                |     |   |              |               |           |      |
|-----------------------|----------------|----------------|-----|---|--------------|---------------|-----------|------|
| <b>388-7242CMRBTM</b> | <b>\$1,551</b> | <b>\$1,768</b> | 176 | 9 | 71/<br>23.75 | 29.5/<br>41.5 | <b>29</b> | 29.5 |
|-----------------------|----------------|----------------|-----|---|--------------|---------------|-----------|------|

- TO ORDER WITH ½ OR ¾ MODESTY PANEL - **ADD '2' (½) OR '3' (¾) TO MODEL NUMBER**  
**EXAMPLE:** 388-7242CM-RBTM-2

### CORNER MODULE RECTANGULAR BULLET

RIGHT EXTENSION W/ FULL MP & GABLE LEG

|                       |                |                |     |   |              |               |           |      |
|-----------------------|----------------|----------------|-----|---|--------------|---------------|-----------|------|
| <b>388-4272CMRBTM</b> | <b>\$1,551</b> | <b>\$1,768</b> | 176 | 9 | 71/<br>23.75 | 41.5/<br>29.5 | <b>29</b> | 29.5 |
|-----------------------|----------------|----------------|-----|---|--------------|---------------|-----------|------|

- TO ORDER WITH ½ OR ¾ MODESTY PANEL - **ADD '2' (½) OR '3' (¾) TO MODEL NUMBER**  
**EXAMPLE:** 388-4272CMRBTM-2
- PENINSULA PRICE BOOK IMAGES SHOWN W/ LAMINATE GABLE LEG CAN HAVE METAL LEGS.  
UPCHARGE WILL BE APPLIED PER LEG SUBSTITUTION OF **\$156**  
SEE **388/600-24**.

**RTA**

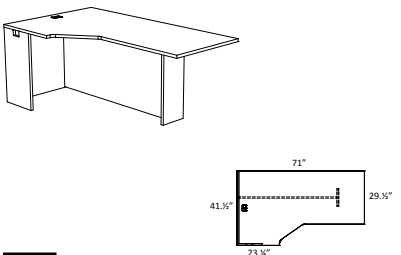

**RTA**

| MODEL | 388  | 600  | WEIGHT | CUBE | W | D | 388 | 600 |
|-------|------|------|--------|------|---|---|-----|-----|
|       | LIST | LIST |        |      |   |   | H   | H   |
|       | 1"   | 1½"  |        |      |   |   | 1"  | 1½" |

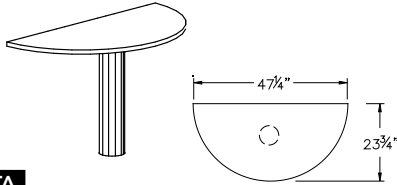

**HALF MOON TOP  
W/ 5" DIAMETER LEG**

|                   |              |              |    |   |       |       |           |      |
|-------------------|--------------|--------------|----|---|-------|-------|-----------|------|
| <b>388-4824HM</b> | <b>\$766</b> | <b>\$873</b> | 35 | 2 | 23.75 | 47.25 | <b>29</b> | 29.5 |
|-------------------|--------------|--------------|----|---|-------|-------|-----------|------|

RTA

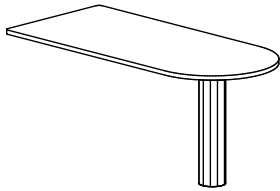

**BULLET TOPS  
W/ 5" DIAMETER LEG**

|                   |              |              |    |     |       |       |           |      |
|-------------------|--------------|--------------|----|-----|-------|-------|-----------|------|
| <b>388-2448BT</b> | <b>\$587</b> | <b>\$669</b> | 45 | 4   | 47.25 | 23.75 | <b>29</b> | 29.5 |
| <b>388-2460BT</b> | <b>\$629</b> | <b>\$717</b> | 50 | 4.2 | 59.25 | 23.75 | <b>29</b> | 29.5 |
| <b>388-2466BT</b> | <b>\$650</b> | <b>\$741</b> | 55 | 4.2 | 65    | 23.75 | <b>29</b> | 29.5 |
| <b>388-3048BT</b> | <b>\$629</b> | <b>\$717</b> | 50 | 4.2 | 47.25 | 29.5  | <b>29</b> | 29.5 |
| <b>388-3060BT</b> | <b>\$691</b> | <b>\$788</b> | 60 | 4.2 | 59.25 | 29.5  | <b>29</b> | 29.5 |
| <b>388-3066BT</b> | <b>\$716</b> | <b>\$816</b> | 65 | 4.7 | 65    | 29.5  | <b>29</b> | 29.5 |
| <b>388-3072BT</b> | <b>\$745</b> | <b>\$849</b> | 70 | 6.2 | 71    | 29.5  | <b>29</b> | 29.5 |

RTA

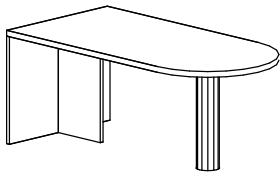

**BULLET TOPS  
W/ FULL GABLE & 5" DIAMETER LEG**

|                    |              |                |     |     |       |       |           |      |
|--------------------|--------------|----------------|-----|-----|-------|-------|-----------|------|
| <b>388-2448BTG</b> | <b>\$692</b> | <b>\$789</b>   | 75  | 3.5 | 47.25 | 23.75 | <b>29</b> | 29.5 |
| <b>388-2460BTG</b> | <b>\$729</b> | <b>\$831</b>   | 80  | 4   | 59.25 | 23.75 | <b>29</b> | 29.5 |
| <b>388-2466BTG</b> | <b>\$781</b> | <b>\$890</b>   | 85  | 4   | 65    | 23.75 | <b>29</b> | 29.5 |
| <b>388-3048BTG</b> | <b>\$762</b> | <b>\$869</b>   | 85  | 4   | 47.25 | 29.5  | <b>29</b> | 29.5 |
| <b>388-3060BTG</b> | <b>\$772</b> | <b>\$880</b>   | 95  | 4.2 | 59.25 | 29.5  | <b>29</b> | 29.5 |
| <b>388-3066BTG</b> | <b>\$816</b> | <b>\$930</b>   | 100 | 4.7 | 65    | 29.5  | <b>29</b> | 29.5 |
| <b>388-3072BTG</b> | <b>\$871</b> | <b>\$993</b>   | 105 | 6   | 71    | 29.5  | <b>29</b> | 29.5 |
| <b>388-3672BTG</b> | <b>\$935</b> | <b>\$1,066</b> | 115 | 7   | 71    | 35.5  | <b>29</b> | 29.5 |

RTA

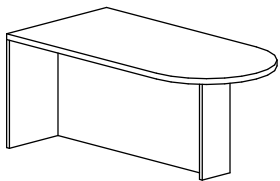

**BULLET TOP  
W/ FULL MODESTY & GABLE LEG**

|                     |              |                |     |     |       |      |           |      |
|---------------------|--------------|----------------|-----|-----|-------|------|-----------|------|
| <b>388-3048BTGM</b> | <b>\$765</b> | <b>\$872</b>   | 90  | 4   | 47.25 | 29.5 | <b>29</b> | 29.5 |
| <b>388-3060BTGM</b> | <b>\$792</b> | <b>\$903</b>   | 95  | 4.2 | 59.25 | 29.5 | <b>29</b> | 29.5 |
| <b>388-3066BTGM</b> | <b>\$873</b> | <b>\$995</b>   | 110 | 4.7 | 65    | 29.5 | <b>29</b> | 29.5 |
| <b>388-3072BTGM</b> | <b>\$931</b> | <b>\$1,061</b> | 120 | 6.2 | 71    | 29.5 | <b>29</b> | 29.5 |
| <b>388-3672BTGM</b> | <b>\$951</b> | <b>\$1,084</b> | 135 | 7   | 71    | 35.5 | <b>29</b> | 29.5 |

RTA

- TO ORDER WITH ½ OR ¾ MODESTY PANEL - **ADD '2' (½) OR '3' (¾) TO MODEL NUMBER**  
**EXAMPLE: 388-33672BTGM-2**
- BULLET TOP PRICE BOOK IMAGES SHOWN WITH LAMINATE GABLE LEG CAN HAVE METAL LEGS. SAME OPTIONS APPLY BUT AN UPCHARGE OF **\$156** LIST WILL BE APPLIED PER LEG SUBSTITUTION. SEE PAGE **388/600-24** FOR LEG OPTIONS.

**FOR ALTERNATE METAL LEG OPTIONS - REFER METAL LEGS PAGE 388/600-24**

# 388/600 PENINSULA TOPS

## RECTANGULAR BULLET TOPS

| MODEL | 388  |      | 600  |                 | WEIGHT | CUBE | W | D | 388 |    | 600 |     |
|-------|------|------|------|-----------------|--------|------|---|---|-----|----|-----|-----|
|       | LIST | LIST | LIST | LIST            |        |      |   |   | H   | H  |     |     |
|       | 1"   | 1½"  | LBS  | FT <sup>3</sup> |        |      |   |   | IN  | IN | 1"  | 1½" |

### RECTANGULAR BULLET TOP

W/ 3" SQUARE LEG

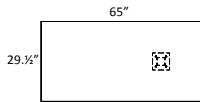
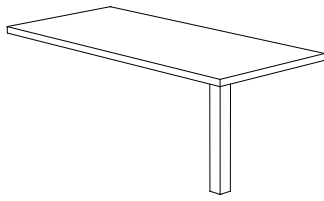

|             |       |       |    |     |       |       |    |      |
|-------------|-------|-------|----|-----|-------|-------|----|------|
| 388-2448RBT | \$603 | \$687 | 47 | 4   | 47.25 | 23.75 | 29 | 29.5 |
| 388-2460RBT | \$626 | \$714 | 52 | 4.2 | 59.25 | 23.75 | 29 | 29.5 |
| 388-2466RBT | \$650 | \$741 | 57 | 4.2 | 65    | 23.75 | 29 | 29.5 |
| 388-3048RBT | \$653 | \$744 | 52 | 4.2 | 47.27 | 29.5  | 29 | 29.5 |
| 388-3060RBT | \$694 | \$791 | 57 | 4.4 | 59.25 | 29.5  | 29 | 29.5 |
| 388-3066RBT | \$851 | \$970 | 62 | 4.4 | 65    | 29.5  | 29 | 29.5 |

- DEFAULT 3" SQUARE LEG IS AVAILABLE IN BLACK (BL), SILVER (SL) OR WHITE (WH). PLEASE CLEARLY INDICATE LAMINATE & LEG FINISH CHOICE ON PO.
- NO GROMMET IN TOP.
- FOR ALTERNATE LEG OPTIONS SEE METAL LEGS. [388/600-24](#)

RTA

### RECTANGULAR BULLET TOP

W/ FULL GABLE & 3" SQUARE LEG

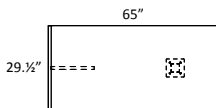
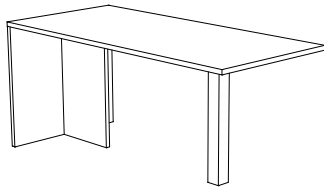

|              |       |         |     |     |       |       |    |      |
|--------------|-------|---------|-----|-----|-------|-------|----|------|
| 388-2448RBTG | \$657 | \$749   | 87  | 4   | 47.25 | 23.75 | 29 | 29.5 |
| 388-2460RBTG | \$713 | \$813   | 92  | 4.2 | 59.25 | 23.75 | 29 | 29.5 |
| 388-2466RBTG | \$757 | \$863   | 97  | 4.2 | 65    | 23.75 | 29 | 29.5 |
| 388-3048RBTG | \$784 | \$894   | 92  | 4.2 | 47.25 | 29.5  | 29 | 29.5 |
| 388-3060RBTG | \$822 | \$937   | 100 | 4.4 | 59.25 | 29.5  | 29 | 29.5 |
| 388-3066RBTG | \$888 | \$1,012 | 106 | 4.4 | 65    | 29.5  | 29 | 29.5 |

- DEFAULT 3" SQUARE LEG IS AVAILABLE IN BLACK (BL), SILVER (SL) OR WHITE (WH). PLEASE CLEARLY INDICATE LAMINATE & LEG FINISH CHOICE ON PO.
- NO GROMMET IN TOP.
- FOR ALTERNATE LEG OPTIONS SEE METAL LEGS. [388/600-24](#)

RTA

### RECTANGULAR BULLET TOP

W/ FULL MODESTY & GABLE LEG

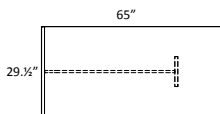
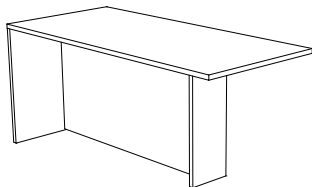

|               |       |         |     |     |       |       |    |      |
|---------------|-------|---------|-----|-----|-------|-------|----|------|
| 388-2448RBTGM | \$670 | \$764   | 87  | 4   | 47.25 | 23.75 | 29 | 29.5 |
| 388-2460RBTGM | \$694 | \$791   | 97  | 4.2 | 59.25 | 23.75 | 29 | 29.5 |
| 388-2466RBTGM | \$762 | \$869   | 102 | 4.2 | 65    | 23.75 | 29 | 29.5 |
| 388-3048RBTGM | \$697 | \$795   | 97  | 4.2 | 47.25 | 29.5  | 29 | 29.5 |
| 388-3060RBTGM | \$800 | \$912   | 112 | 4.4 | 59.25 | 29.5  | 29 | 29.5 |
| 388-3066RBTGM | \$900 | \$1,026 | 117 | 4.4 | 65    | 29.5  | 29 | 29.5 |

- NO GROMMET IN TOP.
- TO ORDER WITH ½ OR ¾ MODESTY PANEL - ADD '2' (½) OR '3' (¾) TO MODEL NUMBER  
**EXAMPLE:** 388-33672RBTGM-2
- PENINSULA PRICE BOOK IMAGES SHOWN WITH LAMINATE GABLE LEG CAN HAVE METAL LEGS. SAME OPTIONS APPLY BUT AN UPCHARGE OF \$156 LIST WILL BE APPLIED PER LEG SUBSTITUTION.
- FOR ALTERNATE LEG OPTIONS SEE METAL LEGS. [388/600-24](#)

RTA

FOR ALTERNATE METAL LEG OPTIONS - REFER METAL LEGS PAGE [388/600-24](#)



| MODEL | 388  | 600  | WEIGHT | CUBE | W | D | 388 | 600 |
|-------|------|------|--------|------|---|---|-----|-----|
|       | LIST | LIST |        |      |   |   | H   | H   |
|       | 1"   | 1½"  |        |      |   |   | 1"  | 1½" |

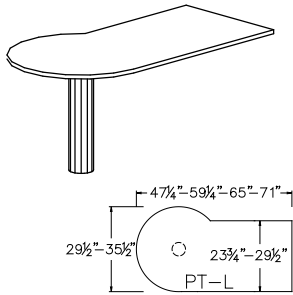

**P-TOP LEFT**  
W/ 5" DIAMETER LEG

|              |       |       |     |     |       |                |    |      |
|--------------|-------|-------|-----|-----|-------|----------------|----|------|
| 388-2448PT-L | \$676 | \$771 | 50  | 4.5 | 47.25 | 29.5/<br>23.75 | 29 | 29.5 |
| 388-2460PT-L | \$716 | \$816 | 55  | 4.8 | 59.25 | 29.5/<br>23.75 | 29 | 29.5 |
| 388-3060PT-L | \$781 | \$890 | 100 | 4.8 | 59.25 | 35.5/<br>29.5  | 29 | 29.5 |
| 388-3066PT-L | \$802 | \$914 | 105 | 5.2 | 65    | 35.5/<br>29.5  | 29 | 29.5 |
| 388-3072PT-L | \$835 | \$952 | 110 | 6   | 71    | 35.5/<br>29.5  | 29 | 29.5 |

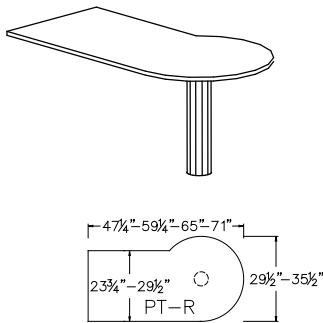

**P-TOP RIGHT**  
W/ 5" DIAMETER LEG

|              |       |       |     |     |       |                |    |      |
|--------------|-------|-------|-----|-----|-------|----------------|----|------|
| 388-2448PT-R | \$676 | \$771 | 50  | 4.5 | 47.25 | 23.75/<br>29.5 | 29 | 29.5 |
| 388-2460PT-R | \$716 | \$816 | 55  | 4.8 | 59.25 | 23.75/<br>29.5 | 29 | 29.5 |
| 388-3060PT-R | \$781 | \$890 | 100 | 4.8 | 59.25 | 29.5/<br>35.5  | 29 | 29.5 |
| 388-3066PT-R | \$802 | \$914 | 105 | 5.2 | 65    | 29.5/<br>35.5  | 29 | 29.5 |
| 388-3072PT-R | \$835 | \$952 | 110 | 6   | 71    | 29.5/<br>35.5  | 29 | 29.5 |

**RTA**

- DEFAULT 5" ROUND LEG IS AVAILABLE IN BLACK (BL).
- NO GROMMET IN TOP.
- FOR ALTERNATE LEG OPTIONS SEE METAL LEGS [388/600-24](#)

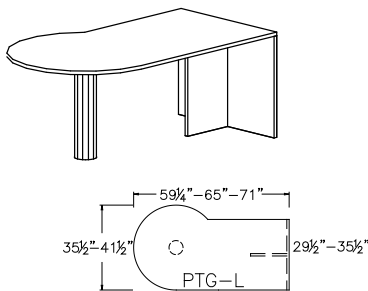

**P-TOP LEFT**  
W/ FULL GABLE & 5" DIAMETER LEG

|               |         |         |     |     |       |               |    |      |
|---------------|---------|---------|-----|-----|-------|---------------|----|------|
| 388-3060PTG-L | \$984   | \$1,122 | 100 | 6   | 59.25 | 29.5/<br>35.5 | 29 | 29.5 |
| 388-3066PTG-L | \$1,031 | \$1,175 | 110 | 6.5 | 65    | 29.5/<br>35.5 | 29 | 29.5 |
| 388-3072PTG-L | \$1,081 | \$1,232 | 120 | 7   | 71    | 29.5/<br>35.5 | 29 | 29.5 |
| 388-3672PTG-L | \$1,113 | \$1,269 | 130 | 7.5 | 71    | 35.5/<br>41.5 | 29 | 29.5 |

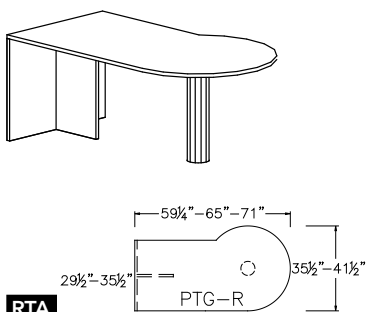

**P-TOP RIGHT**  
W/ FULL GABLE & 5" DIAMETER LEG

|               |         |         |     |     |       |               |    |      |
|---------------|---------|---------|-----|-----|-------|---------------|----|------|
| 388-3060PTG-R | \$984   | \$1,122 | 100 | 6   | 59.25 | 29.5/<br>35.5 | 29 | 29.5 |
| 388-3066PTG-R | \$1,031 | \$1,175 | 110 | 6.5 | 65    | 29.5/<br>35.5 | 29 | 29.5 |
| 388-3072PTG-R | \$1,081 | \$1,232 | 120 | 7   | 71    | 29.5/<br>35.5 | 29 | 29.5 |
| 388-3672PTG-R | \$1,113 | \$1,269 | 130 | 7.5 | 71    | 35.5/<br>41.5 | 29 | 29.5 |

**RTA**

- DEFAULT 5" ROUND LEG IS AVAILABLE IN BLACK (BL).
- NO GROMMET IN TOP.
- FOR ALTERNATE LEG OPTIONS SEE METAL LEGS [388/600-24](#)

FOR ALTERNATE METAL LEG OPTIONS - REFER METAL LEGS PAGE [388/600-24](#)

# 388/600 PENINSULA TOPS P TOPS

| MODEL | 388  |  | 600  |  | WEIGHT | CUBE | W | D | 388 |     | 600 |  |
|-------|------|--|------|--|--------|------|---|---|-----|-----|-----|--|
|       | LIST |  | LIST |  |        |      |   |   | H   | H   |     |  |
|       | 1"   |  | 1½"  |  |        |      |   |   | 1"  | 1½" |     |  |

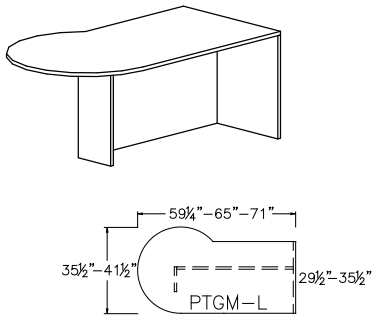

### P-TOP LEFT

W/ FULL MODESTY PANEL & GABLE LEG

|                |         |         |     |     |       |               |    |      |
|----------------|---------|---------|-----|-----|-------|---------------|----|------|
| 388-3060PTGM-L | \$977   | \$1,114 | 105 | 6   | 59.25 | 35.5/<br>29.5 | 29 | 29.5 |
| 388-3066PTGM-L | \$1,026 | \$1,170 | 110 | 6   | 65    | 35.5/<br>29.5 | 29 | 29.5 |
| 388-3072PTGM-L | \$1,081 | \$1,232 | 120 | 6.5 | 71    | 35.5/<br>29.5 | 29 | 29.5 |
| 388-3672PTGM-L | \$1,105 | \$1,260 | 130 | 7   | 71    | 41.5/<br>35.5 | 29 | 29.5 |

- TO ORDER WITH ½ OR ¾ MODESTY PANEL - ADD '2' (½) OR '3' (¾) TO MODEL NUMBER  
**EXAMPLE:** 388-33672PTGM-L-2

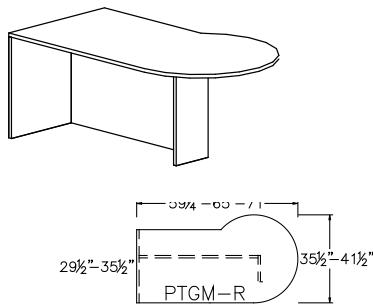

### P-TOP RIGHT

W/ FULL MODESTY PANEL & GABLE LEG

|                |         |         |     |     |       |               |    |      |
|----------------|---------|---------|-----|-----|-------|---------------|----|------|
| 388-3060PTGM-R | \$977   | \$1,114 | 105 | 6   | 59.25 | 29.5/<br>35.5 | 29 | 29.5 |
| 388-3066PTGM-R | \$1,026 | \$1,170 | 110 | 6   | 65    | 29.5/<br>35.5 | 29 | 29.5 |
| 388-3072PTGM-R | \$1,081 | \$1,232 | 120 | 6.5 | 71    | 29.5/<br>35.5 | 29 | 29.5 |
| 388-3672PTGM-R | \$1,105 | \$1,260 | 130 | 7   | 71    | 35.5/<br>41.5 | 29 | 29.5 |

- TO ORDER WITH ½ OR ¾ MODESTY PANEL - ADD '2' (½) OR '3' (¾) TO MODEL NUMBER  
**EXAMPLE:** 388-33672PTGM-R-2
- PENINSULA PRICE BOOK IMAGES SHOWN WITH LAMINATE GABLE LEG CAN HAVE METAL LEGS. SAME OPTIONS APPLY BUT AN UPCHARGE OF \$156 LIST WILL BE APPLIED PER LEG SUBSTITUTION. SEE PAGE 388/600-24 FOR LEG OPTIONS.

RTA

## METAL LEGS

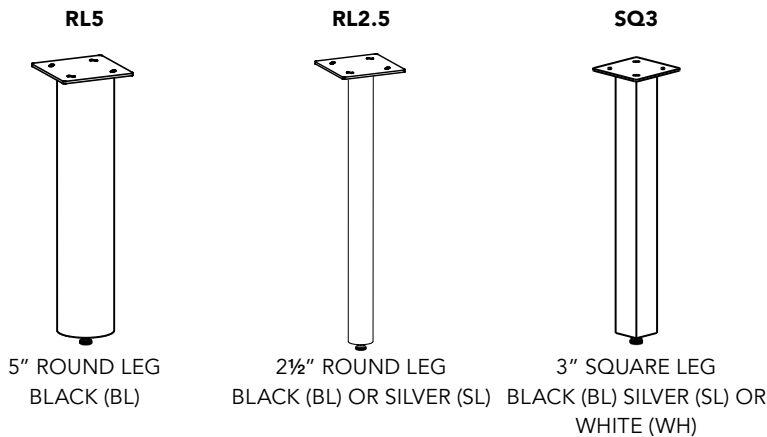

DEFAULT METAL LEGS CAN BE SUBSTITUTED FOR A DIFFERENT METAL LEG, NO EXTRA CHARGE.

**Order Example:** 388-2448BTG HAS DEFAULT 5" DIAMETER LEG TO SUBSTITUTE FOR A SQUARE SILVER (SL) OR WHITE (WH) LEG ORDER:

388-2448BTG-**HM-SQ3-SL**

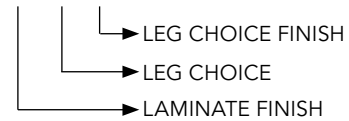

PENINSULA PRICE BOOK IMAGES SHOWN W/ LAMINATE GABLE LEG CAN HAVE METAL LEGS. UPCHARGE WILL BE APPLIED PER LEG SUBSTITUTION OF \$156

| MODEL | 388  | 600  | WEIGHT | CUBE | W | D | 388 | 600 |
|-------|------|------|--------|------|---|---|-----|-----|
|       | LIST | LIST |        |      |   |   | H   | H   |
|       | 1"   | 1½"  |        |      |   |   | 1"  | 1½" |

**BULLET AND WEDGE BULLET TABLES:**

- DESIGNED TO BE A COLLABORATE TABLE AND PUSHED UP AGAINST A WALL.
- DEFAULT FULL HEIGHT DOUBLE MODESTY PANEL RUNNERS TO HIDE WIRES
- GROMMET CENTERED NEAR TOP OF THE END PANEL FOR EASY WIRE PASS THROUGH.
- ¾ HEIGHT OR ½ HEIGHT MODESTIES ARE AVAILABLE.
- ADDITIONAL POWER GROMMETS CAN BE SURFACE MOUNTED AS AN ADD ON FEATURE, SEE ACCESSORIES SERIES 100-6 FOR OPTIONS.
- SHIPS RTA – QUICK READY TO ASSEMBLE.

**BULLET TABLE WITH TRESTLE PANEL SET**

48" BULLET TABLE

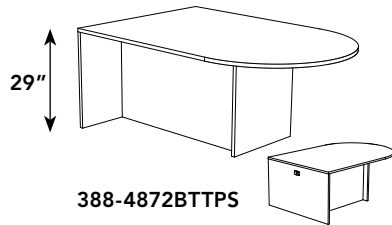

|               |         |         |       |      |       |       |    |      |
|---------------|---------|---------|-------|------|-------|-------|----|------|
| 388-4860BTTPS | \$2,864 | \$3,498 | 127.9 | 5.82 | 59.25 | 47.25 | 29 | 29.5 |
| 388-4872BTTPS | \$3,036 | \$3,706 | 145.5 | 6.94 | 71    | 47.25 | 29 | 29.5 |
| 388-4884BTTPS | \$3,327 | \$3,835 | 163.1 | 8.07 | 82.75 | 47.25 | 29 | 29.5 |
| 388-4896BTTPS | \$3,920 | \$4,765 | 180.8 | 9.19 | 94.5  | 47.25 | 29 | 29.5 |

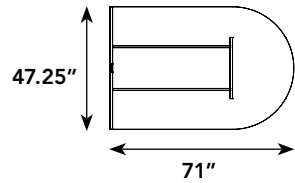

60" BULLET TABLE

|               |         |         |       |      |       |       |    |      |
|---------------|---------|---------|-------|------|-------|-------|----|------|
| 388-6060BTTPS | \$3,490 | \$3,979 | 165.3 | 7.21 | 59.25 | 59.25 | 29 | 29.5 |
| 388-6072BTTPS | \$3,662 | \$4,175 | 185.2 | 8.61 | 71    | 59.25 | 29 | 29.5 |
| 388-6084BTTPS | \$3,952 | \$4,505 | 205   | 10   | 82.75 | 59.25 | 29 | 29.5 |
| 388-6096BTTPS | \$4,545 | \$5,181 | 224.9 | 11.4 | 94.5  | 59.25 | 29 | 29.5 |

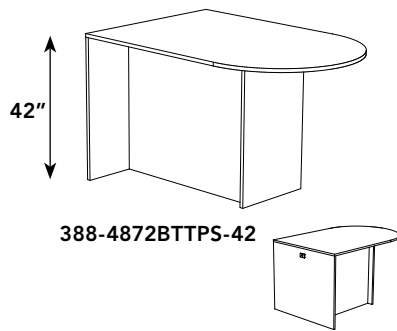

48" BULLET TABLE - 42" HIGH

|                  |         |         |       |       |       |       |    |    |
|------------------|---------|---------|-------|-------|-------|-------|----|----|
| 388-4860BTTPS-42 | \$3,490 | \$4,123 | 138.9 | 7.9   | 59.25 | 47.25 | 42 | 42 |
| 388-4872BTTPS-42 | \$3,662 | \$4,331 | 156.5 | 9.4   | 71    | 47.25 | 42 | 42 |
| 388-4884BTTPS-42 | \$3,952 | \$4,462 | 174.2 | 10.91 | 82.75 | 47.25 | 42 | 42 |
| 388-4896BTTPS-42 | \$4,545 | \$5,390 | 191.8 | 12.44 | 94.5  | 47.25 | 42 | 42 |

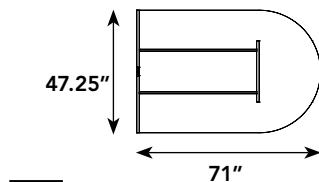

60" BULLET TABLE - 42" HIGH

|                  |         |         |       |       |       |       |    |    |
|------------------|---------|---------|-------|-------|-------|-------|----|----|
| 388-6060BTTPS-42 | \$4,114 | \$4,690 | 176.4 | 9.76  | 59.25 | 59.25 | 42 | 42 |
| 388-6072BTTPS-42 | \$4,287 | \$4,887 | 196.2 | 11.65 | 71    | 59.25 | 42 | 42 |
| 388-6084BTTPS-42 | \$4,578 | \$5,219 | 216.1 | 13.53 | 82.75 | 59.25 | 42 | 42 |
| 388-6096BTTPS-42 | \$5,170 | \$5,894 | 235.9 | 15.42 | 94.5  | 59.25 | 42 | 42 |

**RTA**

# 388/600 TABLES

## BULLET TABLES / WEDGE BULLET TABLES

| MODEL | 388  | 600  | WEIGHT | CUBE | W | D | 388 | 600 |
|-------|------|------|--------|------|---|---|-----|-----|
|       | LIST | LIST |        |      |   |   | H   | H   |
|       | 1"   | 1½"  |        |      |   |   | 1"  | 1½" |

### BULLET TABLE WITH TRESTLE PANEL CUBE

#### 48" BULLET TABLE

|               |         |         |        |      |       |       |    |      |
|---------------|---------|---------|--------|------|-------|-------|----|------|
| 388-4860BTTPC | \$3,176 | \$3,811 | 160.94 | 5.82 | 59.25 | 47.25 | 29 | 29.5 |
| 388-4872BTTPC | \$3,350 | \$4,020 | 178.57 | 6.94 | 71    | 47.25 | 29 | 29.5 |
| 388-4884BTTPC | \$3,638 | \$4,148 | 196.21 | 8.07 | 82.75 | 47.25 | 29 | 29.5 |
| 388-4896BTTPC | \$4,232 | \$5,078 | 213.85 | 9.19 | 94.5  | 47.25 | 29 | 29.5 |

#### 60" BULLET TABLE

|               |         |         |        |        |       |       |    |      |
|---------------|---------|---------|--------|--------|-------|-------|----|------|
| 388-6060BTTPC | \$3,802 | \$4,334 | 198.42 | 7.21   | 59.25 | 59.25 | 29 | 29.5 |
| 388-6072BTTPC | \$3,974 | \$4,530 | 218.26 | 8.61   | 71    | 59.25 | 29 | 29.5 |
| 388-6084BTTPC | \$4,264 | \$4,861 | 238.1  | 10.003 | 82.75 | 59.25 | 29 | 29.5 |
| 388-6096BTTPC | \$4,858 | \$5,538 | 257.94 | 11.4   | 94.5  | 59.25 | 29 | 29.5 |

#### 48" BULLET TABLE - 42" HIGH

|                  |         |         |        |       |       |       |    |    |
|------------------|---------|---------|--------|-------|-------|-------|----|----|
| 388-4860BTTPC-42 | \$3,802 | \$4,436 | 171.96 | 7.87  | 59.25 | 47.25 | 42 | 42 |
| 388-4872BTTPC-42 | \$3,974 | \$4,644 | 189.6  | 9.39  | 71    | 47.25 | 42 | 42 |
| 388-4884BTTPC-42 | \$4,264 | \$4,773 | 207.23 | 10.91 | 82.75 | 47.25 | 42 | 42 |
| 388-4896BTTPC-42 | \$4,858 | \$5,703 | 224.87 | 12.44 | 94.5  | 47.25 | 42 | 42 |

#### 60" BULLET TABLE - 42" HIGH

|                  |         |         |        |       |       |       |    |    |
|------------------|---------|---------|--------|-------|-------|-------|----|----|
| 388-6060BTTPC-42 | \$4,427 | \$5,047 | 209.44 | 9.76  | 59.25 | 59.25 | 42 | 42 |
| 388-6072BTTPC-42 | \$4,600 | \$5,244 | 229.28 | 11.65 | 71    | 59.25 | 42 | 42 |
| 388-6084BTTPC-42 | \$4,890 | \$5,575 | 249.12 | 13.53 | 82.75 | 59.25 | 42 | 42 |
| 388-6096BTTPC-42 | \$5,482 | \$6,249 | 268.96 | 15.42 | 94.5  | 59.25 | 42 | 42 |

- TO ORDER WITH ½ OR ¾ MODESTY PANEL - ADD '2' (½) OR '3' (¾) TO MODEL NUMBER  
**EXAMPLE:** 388-33672PTGM-L-2
- FOR AN OPTIONAL POWER MANAGEMENT ACCESS PANEL PLEASE ADD AN UPCHARGE OF OF \$436

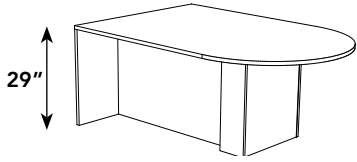

388-4872BTTPC

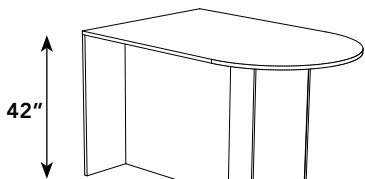
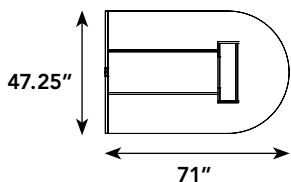

388-4872BTTPS-42

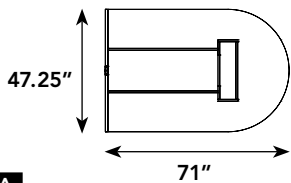
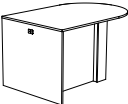

RTA

### WEDGE BULLET TABLE WITH TRESTLE PANEL SET

#### 48" WEDGE BULLET TABLE

|                |         |         |        |      |       |       |    |      |
|----------------|---------|---------|--------|------|-------|-------|----|------|
| 388-4860WBTTPS | \$2,864 | \$3,498 | 127.9  | 5.82 | 59.25 | 47.25 | 29 | 29.5 |
| 388-4872WBTTPS | \$3,036 | \$3,706 | 145.5  | 6.94 | 71    | 47.25 | 29 | 29.5 |
| 388-4884WBTTPS | \$3,327 | \$3,835 | 163.1  | 8.07 | 82.75 | 47.25 | 29 | 29.5 |
| 388-4896WBTTPS | \$3,920 | \$4,765 | 180.78 | 9.19 | 94.5  | 47.25 | 29 | 29.5 |

#### 60" WEDGE BULLET TABLE

|                |         |         |       |      |       |       |    |      |
|----------------|---------|---------|-------|------|-------|-------|----|------|
| 388-6060WBTTPS | \$3,490 | \$3,979 | 165.4 | 7.21 | 59.25 | 59.25 | 29 | 29.5 |
| 388-6072WBTTPS | \$3,662 | \$4,175 | 185.2 | 8.61 | 71    | 59.25 | 29 | 29.5 |
| 388-6084WBTTPS | \$3,952 | \$4,505 | 205.0 | 10.0 | 82.75 | 59.25 | 29 | 29.5 |
| 388-6096WBTTPS | \$4,545 | \$5,181 | 224.9 | 11.4 | 94.5  | 59.25 | 29 | 29.5 |

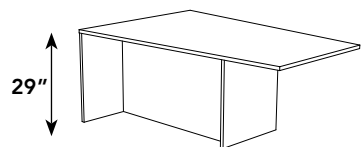

388-4872WBTTPS

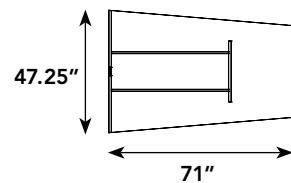

| MODEL | 388  | 600  | WEIGHT | CUBE | W | D | 388 | 600 |
|-------|------|------|--------|------|---|---|-----|-----|
|       | LIST | LIST |        |      |   |   | H   | H   |
|       | 1"   | 1½"  |        |      |   |   | 1"  | 1½" |

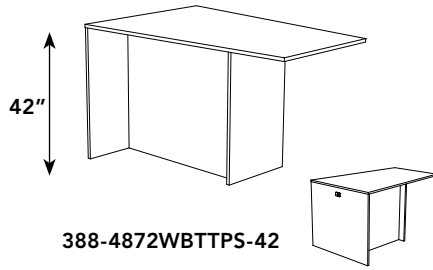

48" WEDGE BULLET TABLE - 42" HIGH

|                   |         |         |       |       |       |       |    |    |
|-------------------|---------|---------|-------|-------|-------|-------|----|----|
| 388-4860WBTTPS-42 | \$3,490 | \$4,123 | 138.9 | 7.87  | 59.25 | 47.25 | 42 | 42 |
| 388-4872WBTTPS-42 | \$3,662 | \$4,331 | 156.5 | 9.39  | 71    | 47.25 | 42 | 42 |
| 388-4884WBTTPS-42 | \$3,952 | \$4,462 | 174.2 | 10.91 | 82.75 | 47.25 | 42 | 42 |
| 388-4896WBTTPS-42 | \$4,545 | \$5,390 | 191.8 | 12.44 | 94.5  | 47.25 | 42 | 42 |

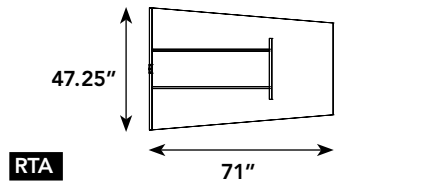

60" WEDGE BULLET TABLE - 42" HIGH

|                   |         |         |       |       |       |       |    |    |
|-------------------|---------|---------|-------|-------|-------|-------|----|----|
| 388-6060WBTTPS-42 | \$4,114 | \$4,690 | 176.4 | 9.76  | 59.25 | 59.25 | 42 | 42 |
| 388-6072WBTTPS-42 | \$4,287 | \$4,887 | 196.2 | 11.65 | 71    | 59.25 | 42 | 42 |
| 388-6084WBTTPS-42 | \$4,578 | \$5,219 | 216.1 | 13.53 | 82.75 | 59.25 | 42 | 42 |
| 388-6096WBTTPS-42 | \$5,170 | \$5,894 | 235.9 | 15.42 | 94.5  | 59.25 | 42 | 42 |

WEDGE BULLET TABLE WITH TRESTLE PANEL CUBE

48" WEDGE BULLET TABLE

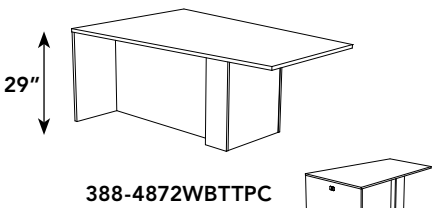

|                |         |         |       |      |       |       |    |      |
|----------------|---------|---------|-------|------|-------|-------|----|------|
| 388-4860WBTTPC | \$3,176 | \$3,811 | 160.9 | 5.82 | 59.25 | 47.25 | 29 | 29.5 |
| 388-4872WBTTPC | \$3,350 | \$4,020 | 178.6 | 6.94 | 71    | 47.25 | 29 | 29.5 |
| 388-4884WBTTPC | \$3,638 | \$4,148 | 196.2 | 8.07 | 82.75 | 47.25 | 29 | 29.5 |
| 388-4896WBTTPC | \$4,232 | \$5,078 | 213.9 | 9.19 | 94.5  | 47.25 | 29 | 29.5 |

60" WEDGE BULLET TABLE

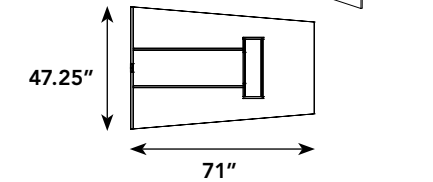

|                |         |         |       |      |       |       |    |      |
|----------------|---------|---------|-------|------|-------|-------|----|------|
| 388-6060WBTTPC | \$3,802 | \$4,334 | 198.4 | 7.21 | 59.25 | 59.25 | 29 | 29.5 |
| 388-6072WBTTPC | \$3,974 | \$4,530 | 218.3 | 8.61 | 71    | 59.25 | 29 | 29.5 |
| 388-6084WBTTPC | \$4,264 | \$4,861 | 238.1 | 10   | 82.75 | 59.25 | 29 | 29.5 |
| 388-6096WBTTPC | \$4,858 | \$5,538 | 257.9 | 11.4 | 94.5  | 59.25 | 29 | 29.5 |

48" WEDGE BULLET TABLE - 42" HIGH

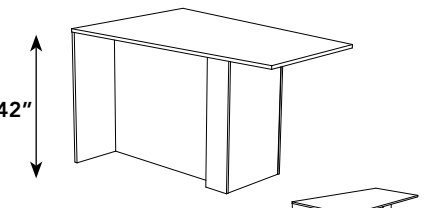

|                   |         |         |       |       |       |       |    |    |
|-------------------|---------|---------|-------|-------|-------|-------|----|----|
| 388-4860WBTTPC-42 | \$3,802 | \$4,436 | 172   | 7.87  | 59.25 | 47.25 | 42 | 42 |
| 388-4872WBTTPC-42 | \$3,974 | \$4,644 | 189.6 | 9.39  | 71    | 47.25 | 42 | 42 |
| 388-4884WBTTPC-42 | \$4,264 | \$4,773 | 207.2 | 10.91 | 82.75 | 47.25 | 42 | 42 |
| 388-4896WBTTPC-42 | \$4,858 | \$5,703 | 224.9 | 12.44 | 94.5  | 47.25 | 42 | 42 |

60" WEDGE BULLET TABLE - 42" HIGH

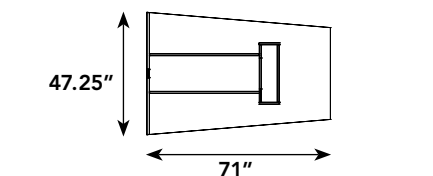

|                   |         |         |       |       |       |       |    |    |
|-------------------|---------|---------|-------|-------|-------|-------|----|----|
| 388-6060WBTTPC-42 | \$4,427 | \$5,047 | 209.4 | 9.76  | 59.25 | 59.25 | 42 | 42 |
| 388-6072WBTTPC-42 | \$4,600 | \$5,244 | 229.3 | 11.65 | 71    | 59.25 | 42 | 42 |
| 388-6084WBTTPC-42 | \$4,890 | \$5,575 | 249.1 | 13.53 | 82.75 | 59.25 | 42 | 42 |
| 388-6096WBTTPC-42 | \$5,482 | \$6,249 | 269   | 15.42 | 94.5  | 59.25 | 42 | 42 |

- TO ORDER WITH ½ OR ¾ MODESTY PANEL - ADD '2' (½) OR '3' (¾) TO MODEL NUMBER  
**EXAMPLE:** 388-33672PTGM-L-2
- FOR AN OPTIONAL POWER MANAGEMENT ACCESS PANEL PLEASE ADD AN UPCHARGE OF OF \$436

RTA

# SHARED COMMUNITY TABLES - DESK HEIGHT

|       | 388  | 600  |        |                 |    |    | 388 | 600 |
|-------|------|------|--------|-----------------|----|----|-----|-----|
| MODEL | LIST | LIST | WEIGHT | CUBE            | W  | D  | H   | H   |
|       | 1"   | 1½"  | LBS    | FT <sup>3</sup> | IN | IN | 1"  | 1½" |

## SHARED COMMUNITY TABLES

- 388 SERIES - 1" TOPS AND 1" GABLES. CENTERED MODESTY PANEL, HALF HEIGHT IS DEFAULT. 3/4 MODESTY AVAILABLE. NO GROMMET
- 600 SERIES - 1½" TOPS AND 1½" GABLES. CENTERED MODESTY PANEL, HALF HEIGHT IS DEFAULT. 3/4 MODESTY AVAILABLE. NO GROMMET

### 24" SHARED COMMUNITY TABLES

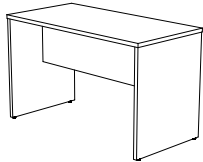

388-2448SCT

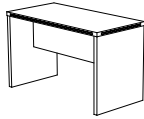

600-2448SCT

|             |         |         |       |     |       |       |    |      |
|-------------|---------|---------|-------|-----|-------|-------|----|------|
| 388-2448SCT | \$693   | \$901   | 75.1  | 2.9 | 47.25 | 23.75 | 29 | 29.5 |
| 388-2454SCT | \$724   | \$941   | 80.3  | 3.2 | 53.25 | 23.75 | 29 | 29.5 |
| 388-2460SCT | \$740   | \$962   | 85.5  | 2.7 | 59.25 | 23.75 | 29 | 29.5 |
| 388-2466SCT | \$780   | \$1,014 | 90.7  | 2.9 | 65    | 23.75 | 29 | 29.5 |
| 388-2472SCT | \$831   | \$1,080 | 95.97 | 3.2 | 71    | 23.75 | 29 | 29.5 |
| 388-2478SCT | \$946   | \$1,230 | 101.2 | 3.4 | 77    | 23.75 | 29 | 29.5 |
| 388-2484SCT | \$1,057 | \$1,374 | 106.4 | 3.7 | 82.75 | 23.75 | 29 | 29.5 |
| 388-2490SCT | \$1,146 | \$1,490 | 111.6 | 3.9 | 88.75 | 23.75 | 29 | 29.5 |
| 388-2496SCT | \$1,249 | \$1,624 | 116.8 | 4.2 | 94.5  | 23.75 | 29 | 29.5 |

### 30" SHARED COMMUNITY TABLES

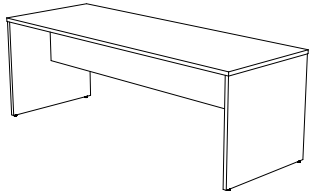

388-3084SCT

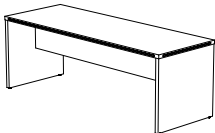

600-3084SCT

|             |         |         |        |     |       |       |    |      |
|-------------|---------|---------|--------|-----|-------|-------|----|------|
| 388-3048SCT | \$755   | \$982   | 90.85  | 3.5 | 47.25 | 29.75 | 29 | 29.5 |
| 388-3054SCT | \$785   | \$1,021 | 96.96  | 3.9 | 53.25 | 29.75 | 29 | 29.5 |
| 388-3060SCT | \$801   | \$1,041 | 103.09 | 3.3 | 59.25 | 29.75 | 29 | 29.5 |
| 388-3066SCT | \$842   | \$1,095 | 109.22 | 3.6 | 65    | 29.75 | 29 | 29.5 |
| 388-3072SCT | \$893   | \$1,161 | 115.35 | 3.9 | 71    | 29.75 | 29 | 29.5 |
| 388-3078SCT | \$1,009 | \$1,312 | 121.45 | 4.2 | 77    | 29.75 | 29 | 29.5 |
| 388-3084SCT | \$1,118 | \$1,453 | 127.58 | 4.6 | 82.75 | 29.75 | 29 | 29.5 |
| 388-3090SCT | \$1,248 | \$1,622 | 133.71 | 4.9 | 88.75 | 29.75 | 29 | 29.5 |
| 388-3096SCT | \$1,338 | \$1,739 | 139.84 | 5.2 | 94.5  | 29.75 | 29 | 29.5 |

### 36" SHARED COMMUNITY TABLES

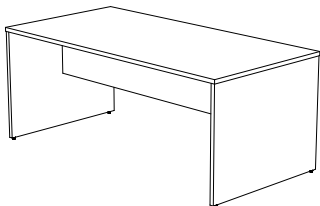

388-3672SCT

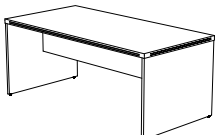

600-3672SCT

|             |         |         |        |      |       |      |    |      |
|-------------|---------|---------|--------|------|-------|------|----|------|
| 388-3648SCT | \$831   | \$1,080 | 106.59 | 4.2  | 47.25 | 35.5 | 29 | 29.5 |
| 388-3654SCT | \$873   | \$1,135 | 113.63 | 4.7  | 53.25 | 35.5 | 29 | 29.5 |
| 388-3660SCT | \$889   | \$1,156 | 120.64 | 3.9  | 59.25 | 35.5 | 29 | 29.5 |
| 388-3666SCT | \$931   | \$1,210 | 127.67 | 4.3  | 65    | 35.5 | 29 | 29.5 |
| 388-3672SCT | \$1,131 | \$1,470 | 134.70 | 4.6  | 71    | 35.5 | 29 | 29.5 |
| 388-3678SCT | \$1,168 | \$1,518 | 141.74 | 5.03 | 77    | 35.5 | 29 | 29.5 |
| 388-3684SCT | \$1,338 | \$1,739 | 148.77 | 5.4  | 82.75 | 35.5 | 29 | 29.5 |
| 388-3690SCT | \$1,380 | \$1,794 | 155.80 | 5.8  | 88.75 | 35.5 | 29 | 29.5 |
| 388-3696SCT | \$1,463 | \$1,902 | 162.83 | 6.2  | 94.5  | 35.5 | 29 | 29.5 |

| MODEL | 388  | 600  | WEIGHT | CUBE | W | D | 388 | 600 |
|-------|------|------|--------|------|---|---|-----|-----|
|       | LIST | LIST |        |      |   |   | H   | H   |
|       | 1"   | 1½"  |        |      |   |   | 1"  | 1½" |

**SHARED COMMUNITY TABLES - 42" HIGH**

- 388 SERIES - 1" TOPS AND 1" GABLES. CENTERED MODESTY PANEL, HALF HEIGHT IS DEFAULT. 3/4 MODESTY AVAILABLE. NO GROMMET.
- 600 SERIES - 1½" TOPS AND 1½" GABLES. CENTERED MODESTY PANEL, HALF HEIGHT IS DEFAULT. 3/4 MODESTY AVAILABLE. NO GROMMET.

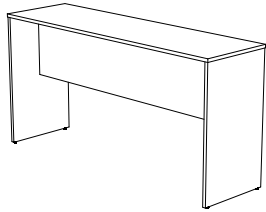

388-2484SCT-42

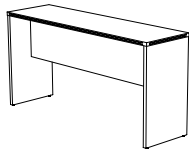

600-2484SCT-42

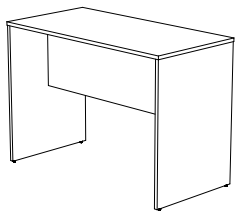

388-3060SCT-42

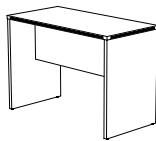

600-3060SCT-42

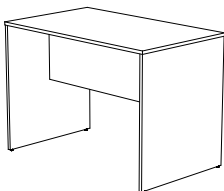

388-3660SCT-42

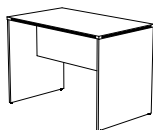

600-3660SCT-42

**24" SHARED COMMUNITY TABLES**

|                |         |         |        |      |       |       |    |    |
|----------------|---------|---------|--------|------|-------|-------|----|----|
| 388-2448SCT-42 | \$832   | \$1,082 | 96.47  | 2.87 | 47.25 | 23.75 | 42 | 42 |
| 388-2454SCT-42 | \$869   | \$1,130 | 101.7  | 3.21 | 53.25 | 23.75 | 42 | 42 |
| 388-2460SCT-42 | \$886   | \$1,152 | 106.92 | 2.67 | 59.25 | 23.75 | 42 | 42 |
| 388-2466SCT-42 | \$937   | \$1,218 | 112.13 | 2.93 | 65    | 23.75 | 42 | 42 |
| 388-2472SCT-42 | \$996   | \$1,295 | 117.35 | 3.18 | 71    | 23.75 | 42 | 42 |
| 388-2478SCT-42 | \$1,135 | \$1,476 | 122.55 | 3.4  | 77    | 23.75 | 42 | 42 |
| 388-2484SCT-42 | \$1,269 | \$1,650 | 127.78 | 3.70 | 82.75 | 23.75 | 42 | 42 |
| 388-2490SCT-42 | \$1,376 | \$1,789 | 132.98 | 3.96 | 88.75 | 23.75 | 42 | 42 |
| 388-2496SCT-42 | \$1,498 | \$1,947 | 138.21 | 4.22 | 94.5  | 23.75 | 42 | 42 |

**30" SHARED COMMUNITY TABLES**

|                |         |         |        |      |       |       |    |    |
|----------------|---------|---------|--------|------|-------|-------|----|----|
| 388-3048SCT-42 | \$906   | \$1,178 | 116.16 | 3.53 | 47.25 | 29.75 | 42 | 42 |
| 388-3054SCT-42 | \$943   | \$1,226 | 122.27 | 3.96 | 53.25 | 29.75 | 42 | 42 |
| 388-3060SCT-42 | \$961   | \$1,249 | 128.4  | 3.28 | 59.25 | 29.75 | 42 | 42 |
| 388-3066SCT-42 | \$1,011 | \$1,314 | 134.53 | 3.60 | 65    | 29.75 | 42 | 42 |
| 388-3072SCT-42 | \$1,073 | \$1,395 | 140.65 | 3.92 | 71    | 29.75 | 42 | 42 |
| 388-3078SCT-42 | \$1,212 | \$1,576 | 146.76 | 4.24 | 77    | 29.75 | 42 | 42 |
| 388-3084SCT-42 | \$1,342 | \$1,745 | 152.89 | 4.56 | 82.75 | 29.75 | 42 | 42 |
| 388-3090SCT-42 | \$1,496 | \$1,945 | 159.02 | 4.87 | 88.75 | 29.75 | 42 | 42 |
| 388-3096SCT-42 | \$1,606 | \$2,088 | 165.15 | 5.19 | 94.5  | 29.75 | 42 | 42 |

**36" SHARED COMMUNITY TABLES**

|                |         |         |        |      |       |      |    |    |
|----------------|---------|---------|--------|------|-------|------|----|----|
| 388-3648SCT-42 | \$996   | \$1,295 | 135.85 | 4.19 | 47.25 | 35.5 | 42 | 42 |
| 388-3654SCT-42 | \$1,049 | \$1,364 | 142.88 | 4.7  | 53.25 | 35.5 | 42 | 42 |
| 388-3660SCT-42 | \$1,065 | \$1,385 | 149.89 | 3.90 | 59.25 | 35.5 | 42 | 42 |
| 388-3666SCT-42 | \$1,116 | \$1,451 | 156.92 | 4.28 | 65    | 35.5 | 42 | 42 |
| 388-3672SCT-42 | \$1,357 | \$1,764 | 163.96 | 4.65 | 71    | 35.5 | 42 | 42 |
| 388-3678SCT-42 | \$1,401 | \$1,821 | 170.99 | 5.03 | 77    | 35.5 | 42 | 42 |
| 388-3684SCT-42 | \$1,606 | \$2,088 | 178.02 | 5.41 | 82.75 | 35.5 | 42 | 42 |
| 388-3690SCT-42 | \$1,657 | \$2,154 | 185.06 | 5.79 | 88.75 | 35.5 | 42 | 42 |
| 388-3696SCT-42 | \$1,755 | \$2,282 | 192.09 | 6.16 | 94.5  | 35.5 | 42 | 42 |

RTA

# 388/600 MAGAZINE TABLES

| MODEL | 388  | 600  | WEIGHT<br>LBS | CUBE<br>FT <sup>3</sup> | W<br>IN | D<br>IN | 388 | 600 |
|-------|------|------|---------------|-------------------------|---------|---------|-----|-----|
|       | LIST | LIST |               |                         |         |         | H   | H   |
|       | 1"   | 1½"  |               |                         |         |         | 1"  | 1½" |

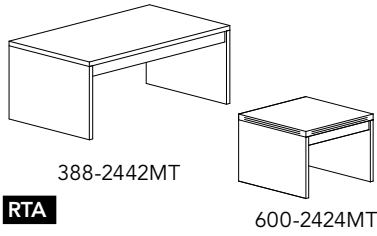

## MAGAZINE TABLE

|            |       |       |    |     |       |       |       |       |
|------------|-------|-------|----|-----|-------|-------|-------|-------|
| 388-2424MT | \$398 | \$454 | 30 | 1.4 | 23.75 | 23.75 | 16.75 | 17.25 |
| 388-2442MT | \$466 | \$531 | 45 | 2.4 | 41.5  | 23.75 | 16.75 | 17.25 |



## OVAL TOP COFFEE TABLE

|             |       |       |    |     |      |       |       |       |
|-------------|-------|-------|----|-----|------|-------|-------|-------|
| 388-2240CFT | \$697 | \$795 | 40 | 1.4 | 39.5 | 21.75 | 16.75 | 17.25 |
|-------------|-------|-------|----|-----|------|-------|-------|-------|

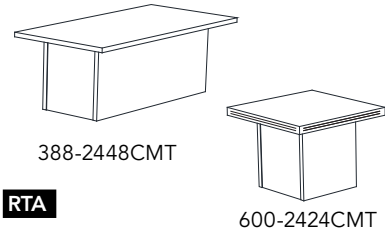

## CUBE BASE MAGAZINE TABLE

|             |       |       |    |     |       |       |       |       |
|-------------|-------|-------|----|-----|-------|-------|-------|-------|
| 388-2424CMT | \$632 | \$720 | 44 | 1.2 | 23.75 | 23.75 | 16.75 | 17.25 |
| 388-2448CMT | \$700 | \$798 | 66 | 2.4 | 47.25 | 23.75 | 16.75 | 17.25 |

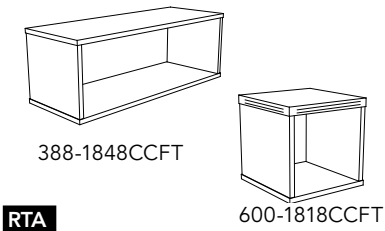

## CUBE COFFEE TABLE

|              |       |       |       |      |       |       |       |       |
|--------------|-------|-------|-------|------|-------|-------|-------|-------|
| 388-1818CCFT | \$537 | \$746 | 31.97 | 0.97 | 17.75 | 17.75 | 16.75 | 17.25 |
| 388-1836CCFT | \$587 | \$850 | 48.5  | 1.43 | 35.5  | 17.75 | 16.75 | 17.25 |
| 388-1848CCFT | \$629 | \$915 | 59.52 | 1.88 | 47.25 | 17.75 | 16.75 | 17.25 |

- OPEN BACK DESIGN / ACCESS FROM BOTH SIDES

# 388/600 DRAWER PEDESTALS

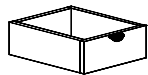

## HANGING PEDESTAL

BOX, NO LOCK.

|         |       |       |    |   |       |       |   |   |
|---------|-------|-------|----|---|-------|-------|---|---|
| 388-HPB | \$440 | \$440 | 20 | 1 | 15.75 | 18.75 | 7 | 7 |
|---------|-------|-------|----|---|-------|-------|---|---|

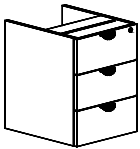

BOX/BOX/BOX, ALL DRAWERS LOCK.

|         |       |       |    |   |       |       |      |      |
|---------|-------|-------|----|---|-------|-------|------|------|
| 388-HPU | \$753 | \$753 | 70 | 4 | 15.75 | 18.75 | 20.5 | 20.5 |
|---------|-------|-------|----|---|-------|-------|------|------|

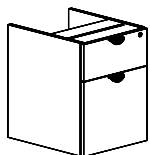

BOX/FILE, ALL DRAWERS LOCK.

|         |       |       |    |   |       |       |      |      |
|---------|-------|-------|----|---|-------|-------|------|------|
| 388-HPF | \$752 | \$752 | 65 | 4 | 15.75 | 18.75 | 20.5 | 20.5 |
|---------|-------|-------|----|---|-------|-------|------|------|



| MODEL | 388  | 600  | WEIGHT | CUBE | W | D | 388 | 600 |
|-------|------|------|--------|------|---|---|-----|-----|
|       | LIST | LIST |        |      |   |   | H   | H   |
|       | 1"   | 1½"  |        |      |   |   | 1"  | 1½" |

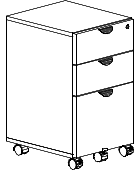

**MOBILE PEDESTAL**

BOX/BOX/FILE, ALL DRAWERS LOCK.

|                     |              |                |    |   |    |       |             |             |
|---------------------|--------------|----------------|----|---|----|-------|-------------|-------------|
| <b>388-1627MPUF</b> | <b>\$965</b> | <b>\$1,023</b> | 85 | 5 | 16 | 18.75 | <b>27.5</b> | <b>27.5</b> |
|---------------------|--------------|----------------|----|---|----|-------|-------------|-------------|

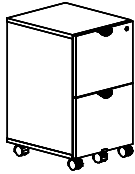

FILE/FILE, ALL DRAWERS LOCK.

|                     |                |                |    |   |    |       |             |             |
|---------------------|----------------|----------------|----|---|----|-------|-------------|-------------|
| <b>388-1627MPFF</b> | <b>\$1,002</b> | <b>\$1,062</b> | 85 | 5 | 16 | 18.75 | <b>27.5</b> | <b>27.5</b> |
|---------------------|----------------|----------------|----|---|----|-------|-------------|-------------|



BOX/FILE, ALL DRAWERS LOCK.

|                    |              |              |    |   |    |       |             |             |
|--------------------|--------------|--------------|----|---|----|-------|-------------|-------------|
| <b>388-1622MPF</b> | <b>\$834</b> | <b>\$884</b> | 65 | 5 | 16 | 18.75 | <b>21.5</b> | <b>21.5</b> |
|--------------------|--------------|--------------|----|---|----|-------|-------------|-------------|

- HEAVY DUTY CASTERS

\*OPTIONAL SEAT CUSHION  
EXAMPLE: WRK-MPEDCUSH-ESC

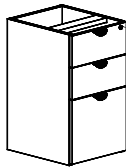

**FREESTANDING PEDESTAL - NO TOP**

BOX/BOX/FILE, ALL DRAWERS LOCK.

|                    |              |              |    |   |       |       |           |           |
|--------------------|--------------|--------------|----|---|-------|-------|-----------|-----------|
| <b>388-19FPUFX</b> | <b>\$871</b> | <b>\$871</b> | 80 | 5 | 15.75 | 18.75 | <b>28</b> | <b>28</b> |
|--------------------|--------------|--------------|----|---|-------|-------|-----------|-----------|

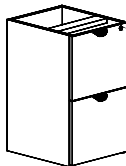

FILE/FILE, ALL DRAWERS LOCK.

|                    |              |              |    |   |       |       |           |           |
|--------------------|--------------|--------------|----|---|-------|-------|-----------|-----------|
| <b>388-19FPFFX</b> | <b>\$939</b> | <b>\$939</b> | 80 | 5 | 15.75 | 18.75 | <b>28</b> | <b>28</b> |
|--------------------|--------------|--------------|----|---|-------|-------|-----------|-----------|

**SEAT CUSHIONS FOR LAMINATE MOBILE PEDESTALS**

| MODEL               | USE ON                    | LIST         |              |               | WEIGHT   | CUBE     | W         | D         | H           |
|---------------------|---------------------------|--------------|--------------|---------------|----------|----------|-----------|-----------|-------------|
|                     |                           | ESCAPE       | HEAVENLY     | ULTRA LEATHER |          |          |           |           |             |
| <b>WRK-MPEDCUSH</b> | 21" HIGH MOBILE PEDESTALS | <b>\$393</b> | <b>\$424</b> | <b>\$456</b>  | <b>4</b> | <b>1</b> | <b>16</b> | <b>18</b> | <b>1.75</b> |

- |                     |   |                      |                           |
|---------------------|---|----------------------|---------------------------|
| <b>ESCAPE</b>       | - 100% POLYESTER, JACQUARD WOVEN<br>- 100% POLYESTER, SOLID PLAIN WEAVE | ADD '-ESC' TO ITEM # | EXAMPLE: WRK-2430CUSH-ESC |
| <b>HEAVENLY</b>     | - 20% RAYON 80% POLYESTER, SOLID PLAIN WEAVE                            | ADD '-HEA' TO ITEM # | EXAMPLE: WRK-2430CUSH-HEA |
| <b>ULTRALEATHER</b> | - 100% POLYVINYL CHLORIDE, FAUX LEATHER, ANTI-BACTERIAL                 | ADD '-ULT' TO ITEM # | EXAMPLE: WRK-2430CUSH-ULT |

**NOTE:** PLEASE REFER TO THE FINISHES & FABRICS TAB ON THE [www.heartwood.ca](http://www.heartwood.ca) WEBSITE FOR A COMPLETE LISTING OF THE COLOUR CHOICES AVAILABLE IN EACH FABRIC. CONTACT CUSTOMER SERVICE IF TWO SEAT CUSHIONS ARE REQUIRED TO BE SIDE BY SIDE AS SIZING MAY NEED TO BE ADJUSTED.

# 388/600 DRAWER PEDESTALS

|       | 388  | 600  |        |                 |    |    | 388 | 600 |
|-------|------|------|--------|-----------------|----|----|-----|-----|
| MODEL | LIST | LIST | WEIGHT | CUBE            | W  | D  | H   | H   |
|       | 1"   | 1½"  | LBS    | FT <sup>3</sup> | IN | IN | 1"  | 1½" |

### FREESTANDING PEDESTAL TOP

TOP FOR NO-TOP FREESTANDING PEDESTALS

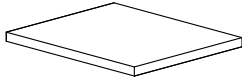

|                    |              |              |          |            |           |              |          |            |
|--------------------|--------------|--------------|----------|------------|-----------|--------------|----------|------------|
| <b>388-19FPTOP</b> | <b>\$143</b> | <b>\$179</b> | <b>8</b> | <b>0.2</b> | <b>16</b> | <b>18.75</b> | <b>1</b> | <b>1.5</b> |
|--------------------|--------------|--------------|----------|------------|-----------|--------------|----------|------------|

### FREESTANDING PEDESTAL TOP

TOP FOR NO-TOP PEDESTALS INV-FPUF AND INV-FPFF ONLY

|                     |              |              |          |            |           |              |          |            |
|---------------------|--------------|--------------|----------|------------|-----------|--------------|----------|------------|
| <b>DINV-22FPTOP</b> | <b>\$187</b> | <b>\$213</b> | <b>9</b> | <b>0.3</b> | <b>16</b> | <b>21.75</b> | <b>1</b> | <b>1.5</b> |
|---------------------|--------------|--------------|----------|------------|-----------|--------------|----------|------------|

**NOTE:** CUSTOMER MUST CONFIRM ON PO HDL PEDESTAL IS 21.75" DEEP.

### METAL MOBILE PEDESTAL - FULL CARTON

FILE / FILE PEDESTAL. ALL DRAWERS LOCK. LOCKING CASTERS.

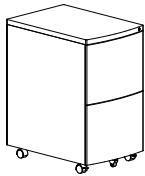

|                  |              |           |          |             |             |             |
|------------------|--------------|-----------|----------|-------------|-------------|-------------|
| <b>100-MMPFF</b> | <b>\$540</b> | <b>55</b> | <b>7</b> | <b>15.5</b> | <b>22.5</b> | <b>27.1</b> |
|------------------|--------------|-----------|----------|-------------|-------------|-------------|

**METAL PEDESTAL FINISHES:** BLACK (BL), TITANIUM (TT) & WHITE (WH)

BOX / BOX / FILE PEDESTAL. ALL DRAWERS LOCK. LOCKING CASTERS.



|                  |              |           |          |             |             |             |
|------------------|--------------|-----------|----------|-------------|-------------|-------------|
| <b>100-MMPUF</b> | <b>\$540</b> | <b>55</b> | <b>7</b> | <b>15.5</b> | <b>22.5</b> | <b>25.2</b> |
|------------------|--------------|-----------|----------|-------------|-------------|-------------|

**METAL PEDESTAL FINISHES:** BLACK (BL), TITANIUM (TT) & WHITE (WH)

- FOR KEYED ALIKE CORE PACKS ADD 100-COREPACK. INCLUDES 1 CORE, 1 CORE REMOVAL KEY AND TWO LOCK KEYS.

**EXAMPLE:** IF YOU REQUIRE 3 UNITS TO BE KEYED-ALIKE, **ORDER 100-COREPACK-3 (\$11 X 3 = \$33).**

SITTING ON **100-MMPFF** OR **100-MMPUF** METAL MOBILE PEDESTALS IS NOT RECOMMENDED.

BOX / FILE PEDESTAL. ALL DRAWERS LOCK. LOCKING CASTERS.

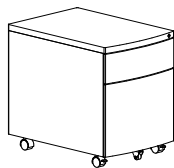

|                 |              |             |             |             |             |             |
|-----------------|--------------|-------------|-------------|-------------|-------------|-------------|
| <b>100-MMPF</b> | <b>\$499</b> | <b>39.7</b> | <b>4.62</b> | <b>15.5</b> | <b>22.5</b> | <b>20.5</b> |
|-----------------|--------------|-------------|-------------|-------------|-------------|-------------|

- MEETS & EXCEEDS ANSI/BIFMA STANDARDS.
- MAXIMUM ADDITIONAL WEIGHT CAPACITY - 220LBS (HEAVY-DUTY CASTERS)
- INCLUDES PENCIL TRAY
- METAL MOBILE PEDESTALS CAN BE KEYED ALIKE: ORDER 100-COREPACK FOR THE NUMBER OF KEYED ALIKE UNITS REQUIRED.

**METAL PEDESTAL FINISHES:** BLACK (BL) & TITANIUM (TT)

### METAL MOBILE PEDESTAL CUSHION

FOR USE WITH 100-MMPF **ONLY**

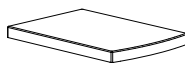

|                        |              |            |             |              |             |          |
|------------------------|--------------|------------|-------------|--------------|-------------|----------|
| <b>100-MMPF-CUSHFA</b> | <b>\$133</b> | <b>7.7</b> | <b>0.49</b> | <b>15.25</b> | <b>22.5</b> | <b>2</b> |
|------------------------|--------------|------------|-------------|--------------|-------------|----------|

**AVAILABLE SEAT CUSHION FINISH:** **CUSHFA** - BLACK (BL), BLUE (BU), LIGHT GREY (GR), RED (RD) & ORANGE (OR)

|                        |              |            |             |              |             |          |
|------------------------|--------------|------------|-------------|--------------|-------------|----------|
| <b>100-MMPF-CUSHPU</b> | <b>\$133</b> | <b>7.7</b> | <b>0.49</b> | <b>15.25</b> | <b>22.5</b> | <b>2</b> |
|------------------------|--------------|------------|-------------|--------------|-------------|----------|

**AVAILABLE SEAT CUSHION FINISH:** **CUSHPU** - BLACK POLYURETHANE (BL)

- CUSHIONS ATTACH WITH VELCRO STRIPS (SUPPLIED).
- 1 CUSHION PER CARTON.

**NOT FOR USE WITH:**  
100-MMPUF  
100-MMPFF

| MODEL | 388  |      | 600       |  | AGD | WEIGHT<br>LBS | CUBE<br>FT <sup>3</sup> | W<br>IN | D<br>IN | 388 |     | 600 |  |
|-------|------|------|-----------|--|-----|---------------|-------------------------|---------|---------|-----|-----|-----|--|
|       | LIST | LIST | UP CHARGE |  |     |               |                         |         |         | H   | H   |     |  |
|       | 1"   | 1½"  |           |  |     |               |                         |         |         | 1"  | 1½" |     |  |

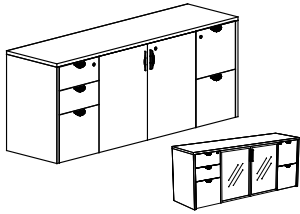

**CREDENZA**

BOX / BOX / FILE / CABINET / FILE / FILE W/ 1 ADJUSTABLE SHELF. LOCKING.

|               |         |         |       |     |    |    |       |    |      |
|---------------|---------|---------|-------|-----|----|----|-------|----|------|
| 388-UF2072CFF | \$2,152 | \$2,453 | \$572 | 275 | 29 | 71 | 19.75 | 29 | 29.5 |
|---------------|---------|---------|-------|-----|----|----|-------|----|------|

388-UF2072CFF -AGD

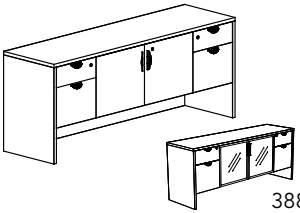

**CREDENZA**

BOX / FILE / CABINET / BOX / FILE. LOCKING.

|             |         |         |       |     |    |    |       |    |      |
|-------------|---------|---------|-------|-----|----|----|-------|----|------|
| 388-F2072CF | \$1,795 | \$2,046 | \$545 | 230 | 29 | 71 | 19.75 | 29 | 29.5 |
|-------------|---------|---------|-------|-----|----|----|-------|----|------|

388-F2072CF-AGD

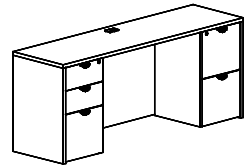

**KNEESPACE CREDENZA**

BOX / BOX / FILE & FILE / FILE. KNEESPACE IS 39" WIDE. LOCKING.

|              |         |         |     |     |    |    |       |    |      |
|--------------|---------|---------|-----|-----|----|----|-------|----|------|
| 388-UF2072FF | \$2,016 | \$2,298 | N/A | 240 | 29 | 71 | 19.75 | 29 | 29.5 |
|--------------|---------|---------|-----|-----|----|----|-------|----|------|

- ONE CENTERED GROMMET. INDICATE ON PO IF GROMMET IS **NOT** REQUIRED, NO EXTRA CHARGE.

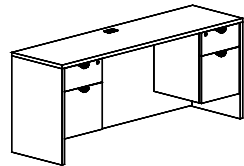

**KNEESPACE CREDENZA**

BOX / FILE & BOX / FILE. KNEESPACE IS 39" WIDE. LOCKING.

|            |         |         |     |     |    |    |       |    |      |
|------------|---------|---------|-----|-----|----|----|-------|----|------|
| 388-F2072F | \$1,417 | \$1,615 | N/A | 210 | 29 | 71 | 19.75 | 29 | 29.5 |
|------------|---------|---------|-----|-----|----|----|-------|----|------|

- ONE CENTERED GROMMET. INDICATE ON PO IF GROMMET IS **NOT** REQUIRED, NO EXTRA CHARGE.

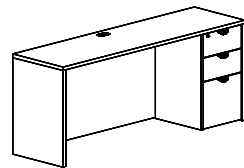

388-2072UF

**SINGLE RIGHT PEDESTAL CREDENZA**

BOX / BOX / FILE. LOCKING.

|            |         |         |     |     |    |    |       |    |      |
|------------|---------|---------|-----|-----|----|----|-------|----|------|
| 388-2072UF | \$1,339 | \$1,526 | N/A | 185 | 29 | 71 | 19.75 | 29 | 29.5 |
|------------|---------|---------|-----|-----|----|----|-------|----|------|

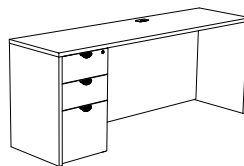

388-UF2072

**SINGLE LEFT PEDESTAL CREDENZA**

BOX / BOX / FILE. LOCKING.

|            |         |         |     |     |    |    |       |    |      |
|------------|---------|---------|-----|-----|----|----|-------|----|------|
| 388-UF2072 | \$1,339 | \$1,526 | N/A | 185 | 29 | 71 | 19.75 | 29 | 29.5 |
|------------|---------|---------|-----|-----|----|----|-------|----|------|

- ONE GROMMET CENTERED IN KNEESPACE. INDICATE ON PO IF GROMMET IS **NOT** REQUIRED, NO EXTRA CHARGE.

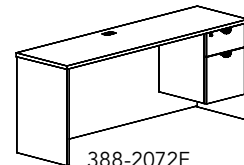

388-2072F

**SINGLE RIGHT PEDESTAL CREDENZA**

BOX / FILE. LOCKING.

|           |         |         |     |     |    |    |       |    |      |
|-----------|---------|---------|-----|-----|----|----|-------|----|------|
| 388-2072F | \$1,144 | \$1,304 | N/A | 170 | 29 | 71 | 19.75 | 29 | 29.5 |
|-----------|---------|---------|-----|-----|----|----|-------|----|------|

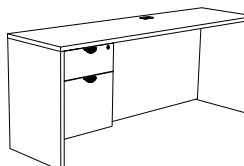

388-F2072





**SINGLE LEFT PEDESTAL CREDENZA**

BOX / FILE. LOCKING.

|           |         |         |     |     |    |    |       |    |      |
|-----------|---------|---------|-----|-----|----|----|-------|----|------|
| 388-F2072 | \$1,144 | \$1,304 | N/A | 170 | 29 | 71 | 19.75 | 29 | 29.5 |
|-----------|---------|---------|-----|-----|----|----|-------|----|------|

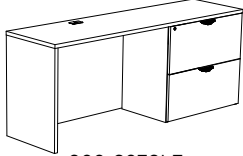
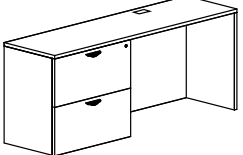
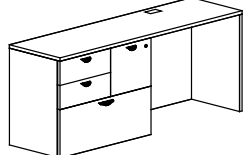
- ONE GROMMET CENTERED IN KNEESPACE. INDICATE ON PO IF GROMMET IS **NOT** REQUIRED, NO EXTRA CHARGE.

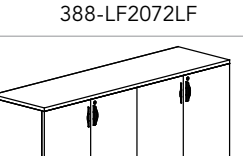
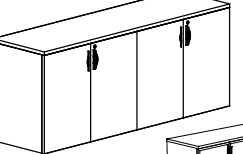
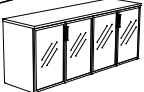
# 388/600 CREDENZAS

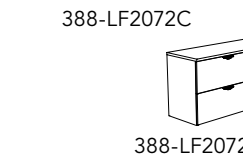
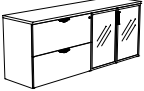
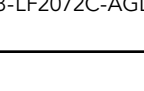
|   | 388            | 600            |                |        |                 |       |       |           | 388         | 600 |
|---|----------------|----------------|----------------|--------|-----------------|-------|-------|-----------|-------------|-----|
| MODEL   | LIST           | LIST           | AGD            | WEIGHT | CUBE            | W     | D     | H         | H           |     |
|   | 1"             | 1½"            | UP CHARGE      | LBS    | FT <sup>3</sup> | IN    | IN    | 1"        | 1½"         |     |
| <b>KNEESPACE / RIGHT LATERAL FILE</b>   |                |                |                |        |                 |       |       |           |             |     |
| 41" KNEESPACE & 30" LATERAL FILE. LOCKING.  |                |                |                |        |                 |       |       |           |             |     |
| <br>388-2072LF  | <b>\$1,943</b> | <b>\$2,215</b> | <i>N/A</i>     | 205    | 29              | 71    | 19.75 | <b>29</b> | <b>29.5</b> |     |
| <b>LEFT LATERAL FILE / KNEESPACE</b>  |                |                |                |        |                 |       |       |           |             |     |
| 41" KNEESPACE & 30" LATERAL FILE. LOCKING.  |                |                |                |        |                 |       |       |           |             |     |
| <br>388-LF2072  | <b>\$1,943</b> | <b>\$2,215</b> | <i>N/A</i>     | 205    | 29              | 71    | 19.75 | <b>29</b> | <b>29.5</b> |     |
| <ul style="list-style-type: none"> <li>ONE GROMMET CENTERED IN KNEESPACE. INDICATE ON PO IF GROMMET IS <b>NOT</b> REQUIRED, NO EXTRA CHARGE.</li> </ul> |                |                |                |        |                 |       |       |           |             |     |
| <b>LEFT LATERAL FILE CREDENZA</b>   |                |                |                |        |                 |       |       |           |             |     |
| LATERAL / BBF COMBO/ KNEESPACE. LATERAL FILE & FILE DRAWER LOCK   |                |                |                |        |                 |       |       |           |             |     |
| <br>388-UFL2072   | <b>\$2,087</b> | <b>\$2,379</b> | <i>N/A</i>     | 240    | 26              | 71    | 19.75 | <b>29</b> | <b>29.5</b> |     |
| <b>RIGHT LATERAL FILE CREDENZA</b>  |                |                |                |        |                 |       |       |           |             |     |
| KNEESPACE / LATERAL / BBF COMBO. LATERAL FILE & FILE DRAWER LOCK.   |                |                |                |        |                 |       |       |           |             |     |
| <br>388-2072UFL  | <b>\$2,087</b> | <b>\$2,379</b> | <i>N/A</i>     | 240    | 26              | 71    | 19.75 | <b>29</b> | <b>29.5</b> |     |
| <ul style="list-style-type: none"> <li>ONE GROMMET CENTERED IN KNEESPACE. INDICATE ON PO IF GROMMET IS <b>NOT</b> REQUIRED, NO EXTRA CHARGE.</li> </ul> |                |                |                |        |                 |       |       |           |             |     |
| <b>CREDENZA</b>   |                |                |                |        |                 |       |       |           |             |     |
| 4 DRAWER LATERAL FILE. LOCKING.   |                |                |                |        |                 |       |       |           |             |     |
| <br>388-LF2060LF  | <b>\$2,152</b> | <b>\$2,453</b> | <i>N/A</i>     | 275    | 26              | 59.25 | 19.75 | <b>29</b> | <b>29.5</b> |     |
| <br>388-LF2072LF  | <b>\$2,559</b> | <b>\$2,917</b> | <i>N/A</i>     | 300    | 29              | 71    | 19.75 | <b>29</b> | <b>29.5</b> |     |
| <b>CREDENZA</b>   |                |                |                |        |                 |       |       |           |             |     |
| 4 CABINET DOORS W/ CENTER DIVIDER & 1 ADJUSTABLE SHELF EACH SIDE. LOCKING.  |                |                |                |        |                 |       |       |           |             |     |
| <br>388-C2072C  | <b>\$1,834</b> | <b>\$2,091</b> | <i>\$1,116</i> | 260    | 26              | 59.25 | 19.75 | <b>29</b> | <b>29.5</b> |     |
| <br>388-C2072C-AGD   | <b>\$1,939</b> | <b>\$2,210</b> | <i>\$1,143</i> | 275    | 29              | 71    | 19.75 | <b>29</b> | <b>29.5</b> |     |
| <b>CREDENZA LATERAL FILE/CABINET</b>  |                |                |                |        |                 |       |       |           |             |     |
| 30" LATERAL FILE & 30" CABINET. LOCKING.  |                |                |                |        |                 |       |       |           |             |     |
| <br>388-LF2060C   | <b>\$1,920</b> | <b>\$2,189</b> | <i>\$558</i>   | 265    | 26              | 59.25 | 19.75 | <b>29</b> | <b>29.5</b> |     |
| 36" LATERAL FILE & 36" CABINET. LOCKING.  |                |                |                |        |                 |       |       |           |             |     |
| <br>388-LF2072C   | <b>\$2,229</b> | <b>\$2,541</b> | <i>\$572</i>   | 290    | 29              | 71    | 19.75 | <b>29</b> | <b>29.5</b> |     |
| 30" CABINET & 30" LATERAL FILE. LOCKING.  |                |                |                |        |                 |       |       |           |             |     |
| <br>388-C2060LF  | <b>\$1,920</b> | <b>\$2,189</b> | <i>\$558</i>   | 265    | 26              | 59.25 | 19.75 | <b>29</b> | <b>29.5</b> |     |
| 36" CABINET & 36" LATERAL FILE. LOCKING.  |                |                |                |        |                 |       |       |           |             |     |
| <br>388-LF2072C-AGD  | <b>\$2,229</b> | <b>\$2,541</b> | <i>\$572</i>   | 290    | 29              | 71    | 19.75 | <b>29</b> | <b>29.5</b> |     |

| MODEL | 388  | 600  | WEIGHT | CUBE | W | D | 388 | 600 |
|-------|------|------|--------|------|---|---|-----|-----|
|       | LIST | LIST |        |      |   |   | H   | H   |
|       | 1"   | 1½"  |        |      |   |   | 1"  | 1½" |

**LATERAL FILE**

20" DEEP WITH LOCKING LATERAL FILE DRAWERS

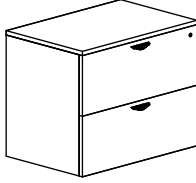

388-2436LF

|            |         |         |     |    |      |       |    |      |
|------------|---------|---------|-----|----|------|-------|----|------|
| 388-2030LF | \$1,076 | \$1,227 | 120 | 13 | 29.5 | 19.75 | 29 | 29.5 |
| 388-2036LF | \$1,113 | \$1,269 | 135 | 15 | 35.5 | 19.75 | 29 | 29.5 |

24" DEEP WITH LOCKING LATERAL FILE DRAWERS

|            |         |         |     |    |      |       |    |      |
|------------|---------|---------|-----|----|------|-------|----|------|
| 388-2430LF | \$1,142 | \$1,302 | 130 | 15 | 29.5 | 23.75 | 29 | 29.5 |
| 388-2436LF | \$1,167 | \$1,330 | 145 | 18 | 35.5 | 23.75 | 29 | 29.5 |

**LATERAL FILE - NO TOP**

19" DEEP. FITS UNDER WORK SURFACE. LOCKING LATERAL FILE DRAWERS.

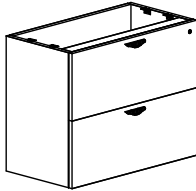

388-1936LFX

|             |         |         |     |    |      |       |    |    |
|-------------|---------|---------|-----|----|------|-------|----|----|
| 388-1930LFX | \$1,053 | \$1,053 | 90  | 12 | 29.5 | 18.75 | 28 | 28 |
| 388-1936LFX | \$1,087 | \$1,087 | 100 | 15 | 35.5 | 18.75 | 28 | 28 |

**30" OPEN LATERAL FILE STORAGE**

20" DEEP W/ LOCKING LATERAL FILE DRAWER.

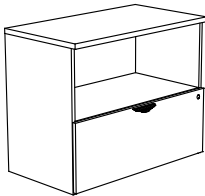

388-2036OLF

|             |         |         |    |      |      |       |    |      |
|-------------|---------|---------|----|------|------|-------|----|------|
| 388-2030OLF | \$1,031 | \$1,141 | 75 | 13.3 | 29.5 | 19.75 | 29 | 29.5 |
| 388-2036OLF | \$1,076 | \$1,177 | 85 | 15.5 | 35.5 | 19.75 | 29 | 29.5 |

24" DEEP W/ LOCKING LATERAL FILE DRAWER.

|             |         |         |    |      |      |       |    |      |
|-------------|---------|---------|----|------|------|-------|----|------|
| 388-2430OLF | \$1,084 | \$1,197 | 90 | 15.5 | 29.5 | 23.75 | 29 | 29.5 |
| 388-2436OLF | \$1,130 | \$1,238 | 95 | 18.5 | 35.5 | 23.75 | 29 | 29.5 |

**OPEN LATERAL FILE STORAGE - NO TOP**

19" DEEP FITS UNDER WORK SURFACE. LOCKING LATERAL FILE DRAWER.

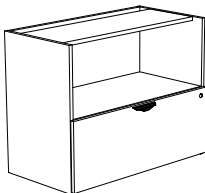

388-1936OLF

|             |       |       |    |      |      |       |    |    |
|-------------|-------|-------|----|------|------|-------|----|----|
| 388-1930OLF | \$900 | \$900 | 70 | 13.3 | 29.5 | 18.75 | 28 | 28 |
| 388-1936OLF | \$962 | \$962 | 80 | 15.5 | 35.5 | 18.75 | 28 | 28 |

**TALL LATERAL FILES**

3 DRAWER LATERAL. INCLUDES ANTI-TILT LOCK.

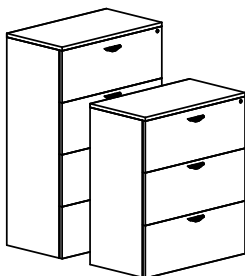

|             |         |         |     |    |      |       |       |       |
|-------------|---------|---------|-----|----|------|-------|-------|-------|
| 388-2036LF3 | \$2,156 | \$2,285 | 200 | 22 | 35.5 | 19.75 | 42.75 | 43.25 |
| 388-2436LF3 | \$2,262 | \$2,398 | 222 | 26 | 35.5 | 23.75 | 42.75 | 43.25 |

4 DRAWER LATERAL. INCLUDES ANTI-TILT LOCK.

|             |         |         |     |    |      |       |       |       |
|-------------|---------|---------|-----|----|------|-------|-------|-------|
| 388-2036LF4 | \$2,711 | \$2,874 | 260 | 29 | 35.5 | 19.75 | 56.25 | 56.75 |
| 388-2436LF4 | \$2,801 | \$2,969 | 282 | 34 | 35.5 | 23.75 | 56.25 | 56.75 |

# 388/600 STORAGE CABINETS

## LATERAL FILE STORAGE

| MODEL | 388  |      | 600  |                 | WEIGHT | CUBE | W | D | 388 |    | 600 |     |
|-------|------|------|------|-----------------|--------|------|---|---|-----|----|-----|-----|
|       | LIST | LIST | LIST | LIST            |        |      |   |   | H   | H  |     |     |
|       | 1"   | 1½"  | LBS  | FT <sup>3</sup> |        |      |   |   | IN  | IN | 1"  | 1½" |

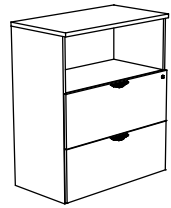

388-2036OLF3

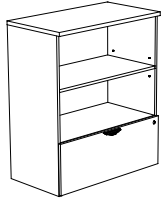

388-2036O2LF3

### OPEN TALL LATERAL FILE STORAGE

OPEN SHELF/TWO LOCKING LATERAL FILE DRAWERS

|              |         |         |     |      |      |       |       |       |
|--------------|---------|---------|-----|------|------|-------|-------|-------|
| 388-2036OLF3 | \$1,889 | \$2,002 | 184 | 21.3 | 35.5 | 19.75 | 42.75 | 43.25 |
| 388-2436OLF3 | \$1,965 | \$2,083 | 202 | 25   | 35.5 | 23.75 | 42.75 | 43.25 |

OPEN SHELF/ OPEN SHELF/ LOCKING LATERAL FILE DRAWER. 1 ADJUSTABLE SHELF.

|               |         |         |     |      |      |       |       |       |
|---------------|---------|---------|-----|------|------|-------|-------|-------|
| 388-2036O2LF3 | \$1,638 | \$1,736 | 169 | 21.3 | 35.5 | 19.75 | 42.75 | 43.25 |
| 388-2436O2LF3 | \$1,689 | \$1,790 | 191 | 25   | 35.5 | 23.75 | 42.75 | 43.25 |

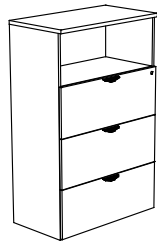

388-2036OLF4

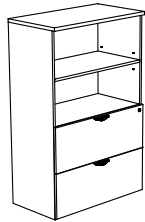

388-2036O2LF4

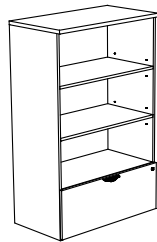

388-2036O3LF4

### OPEN TALL LATERAL FILE STORAGE

OPEN SHELF/THREE LOCKING LATERAL FILE DRAWERS, ANTI-TILT

|              |         |         |     |      |      |       |       |       |
|--------------|---------|---------|-----|------|------|-------|-------|-------|
| 388-2036OLF4 | \$2,274 | \$2,410 | 230 | 27   | 35.5 | 19.75 | 56.25 | 56.75 |
| 388-2436OLF4 | \$2,400 | \$2,544 | 250 | 31.3 | 35.5 | 23.75 | 56.25 | 56.75 |

OPEN SHELF/OPEN SHELF/TWO LOCKING LATERAL FILE DRAWERS. 1 ADJUSTABLE SHELF.

|               |         |         |     |      |      |       |       |       |
|---------------|---------|---------|-----|------|------|-------|-------|-------|
| 388-2036O2LF4 | \$2,027 | \$2,149 | 215 | 27   | 35.5 | 19.75 | 56.25 | 56.75 |
| 388-2436O2LF4 | \$2,185 | \$2,316 | 237 | 31.3 | 35.5 | 23.75 | 56.25 | 56.75 |

OPEN SHELF/OPEN SHELF/OPEN SHELF/ LOCKING LATERAL FILE DRAWER. 2 ADJUSTABLE SHELVES.

|               |         |         |     |      |      |       |       |       |
|---------------|---------|---------|-----|------|------|-------|-------|-------|
| 388-2036O3LF4 | \$1,776 | \$1,883 | 199 | 27   | 35.5 | 19.75 | 56.25 | 56.75 |
| 388-2436O3LF4 | \$1,826 | \$1,936 | 226 | 31.3 | 35.5 | 23.75 | 56.25 | 56.75 |

### LATERAL BBF COMBO

20" DEEP LOCKING FILE & LATERAL FILE DRAWERS.

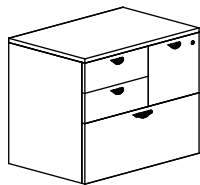

388-2436UFL

|             |         |         |     |    |      |       |    |      |
|-------------|---------|---------|-----|----|------|-------|----|------|
| 388-2030UFL | \$1,419 | \$1,618 | 120 | 12 | 29.5 | 19.75 | 29 | 29.5 |
| 388-2036UFL | \$1,474 | \$1,680 | 135 | 15 | 35.5 | 19.75 | 29 | 29.5 |

24" DEEP LOCKING FILE & LATERAL FILE DRAWERS.

|             |         |         |     |    |      |       |    |      |
|-------------|---------|---------|-----|----|------|-------|----|------|
| 388-2436UFL | \$1,491 | \$1,700 | 150 | 18 | 35.5 | 23.75 | 29 | 29.5 |
|-------------|---------|---------|-----|----|------|-------|----|------|

### LATERAL BBF COMBO - NO TOP

LOCKING FILE & LATERAL FILE DRAWERS. FITS UNDER WORK SURFACE.

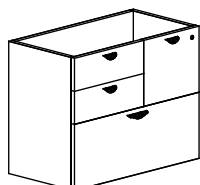

388-1936UFLX

|              |         |         |     |    |      |       |    |    |
|--------------|---------|---------|-----|----|------|-------|----|----|
| 388-1930UFLX | \$1,315 | \$1,315 | 85  | 12 | 29.5 | 18.75 | 28 | 28 |
| 388-1936UFLX | \$1,405 | \$1,405 | 100 | 15 | 35.5 | 18.75 | 28 | 28 |

| MODEL | 388  |      | 600       |     | AGD | WEIGHT<br>LBS | CUBE<br>FT <sup>3</sup> | W<br>IN | D<br>IN | 388 |     | 600 |  |
|-------|------|------|-----------|-----|-----|---------------|-------------------------|---------|---------|-----|-----|-----|--|
|       | LIST | LIST | AGD       | AGD |     |               |                         |         |         | H   | H   |     |  |
|       | 1"   | 1½"  | UP CHARGE |     |     |               |                         |         |         | 1"  | 1½" |     |  |

**OPEN LATERAL FILE/BOX/BOX COMBO STORAGE**

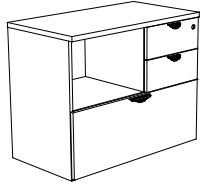

388-2036OBBLF

OPEN SHELF/BOX/BOX/LATERAL FILE STORAGE  
20" DEEP W/ LOCKING BOX & LATERAL FILE DRAWERS

|                      |                |                |     |     |      |      |       |    |      |
|----------------------|----------------|----------------|-----|-----|------|------|-------|----|------|
| <b>388-2036OBBLF</b> | <b>\$1,370</b> | <b>\$1,452</b> | N/A | 160 | 15.5 | 35.5 | 19.75 | 29 | 29.5 |
|----------------------|----------------|----------------|-----|-----|------|------|-------|----|------|

OPEN SHELF/BOX/BOX/LATERAL FILE STORAGE  
24" DEEP W/ LOCKING BOX & LATERAL FILE DRAWERS

|                      |                |                |     |     |      |      |       |    |      |
|----------------------|----------------|----------------|-----|-----|------|------|-------|----|------|
| <b>388-2436OBBLF</b> | <b>\$1,425</b> | <b>\$1,511</b> | N/A | 178 | 18.5 | 35.5 | 23.75 | 29 | 29.5 |
|----------------------|----------------|----------------|-----|-----|------|------|-------|----|------|

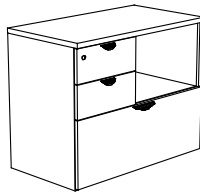

388-2036BBOLF

BOX/BOX/OPEN SHELF/LATERAL FILE STORAGE  
20" DEEP W/ LOCKING BOX & LATERAL FILE DRAWERS

|                      |                |                |     |     |      |      |       |    |      |
|----------------------|----------------|----------------|-----|-----|------|------|-------|----|------|
| <b>388-2036BBOLF</b> | <b>\$1,370</b> | <b>\$1,561</b> | N/A | 160 | 15.5 | 35.5 | 19.75 | 29 | 29.5 |
|----------------------|----------------|----------------|-----|-----|------|------|-------|----|------|

BOX/BOX/OPEN SHELF/LATERAL FILE STORAGE  
24" DEEP W/ LOCKING BOX & LATERAL FILE DRAWERS

|                      |                |                |     |     |      |      |       |    |      |
|----------------------|----------------|----------------|-----|-----|------|------|-------|----|------|
| <b>388-2436BBOLF</b> | <b>\$1,425</b> | <b>\$1,625</b> | N/A | 178 | 18.5 | 35.5 | 23.75 | 29 | 29.5 |
|----------------------|----------------|----------------|-----|-----|------|------|-------|----|------|

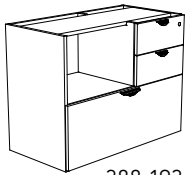

388-1936OBBLFX

**OPEN LATERAL FILE/BOX/BOX COMBO STORAGE - NO TOP**

OPEN SHELF/BOX/BOX/LATERAL FILE STORAGE  
19" DEEP W/ LOCKING BOX & LATERAL FILE DRAWERS FITS UNDER WORK SURFACE.

|                       |                |                |     |     |      |      |       |    |    |
|-----------------------|----------------|----------------|-----|-----|------|------|-------|----|----|
| <b>388-1936OBBLFX</b> | <b>\$1,256</b> | <b>\$1,256</b> | N/A | 141 | 15.5 | 35.5 | 19.75 | 28 | 28 |
|-----------------------|----------------|----------------|-----|-----|------|------|-------|----|----|

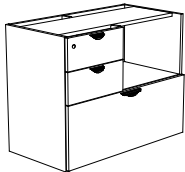

388-1936BBOLFX

BOX/BOX/OPEN SHELF/LATERAL FILE STORAGE  
19" DEEP W/ LOCKING BOX & LATERAL FILE DRAWERS FITS UNDER WORK SURFACE.

|                       |                |                |     |     |      |      |       |    |    |
|-----------------------|----------------|----------------|-----|-----|------|------|-------|----|----|
| <b>388-1936BBOLFX</b> | <b>\$1,256</b> | <b>\$1,256</b> | N/A | 141 | 15.5 | 35.5 | 19.75 | 28 | 28 |
|-----------------------|----------------|----------------|-----|-----|------|------|-------|----|----|

**CABINET STORAGE**

**DOUBLE DOOR CABINET**

20" DEEP W/ 1 ADJUSTABLE SHELF. 2 LOCKING HINGED DOORS.

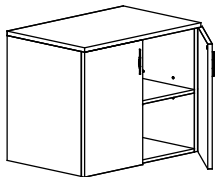

388-2030C

|                  |              |              |              |     |    |      |       |    |      |
|------------------|--------------|--------------|--------------|-----|----|------|-------|----|------|
| <b>388-2030C</b> | <b>\$871</b> | <b>\$993</b> | <i>\$558</i> | 100 | 13 | 29.5 | 19.75 | 29 | 29.5 |
|------------------|--------------|--------------|--------------|-----|----|------|-------|----|------|

|                  |              |                |              |     |    |      |       |    |      |
|------------------|--------------|----------------|--------------|-----|----|------|-------|----|------|
| <b>388-2036C</b> | <b>\$913</b> | <b>\$1,041</b> | <i>\$572</i> | 115 | 15 | 35.5 | 19.75 | 29 | 29.5 |
|------------------|--------------|----------------|--------------|-----|----|------|-------|----|------|

24" DEEP W/ 1 ADJUSTABLE SHELF & 2 LOCKING HINGED DOORS.

|                  |              |                |              |     |    |      |       |    |      |
|------------------|--------------|----------------|--------------|-----|----|------|-------|----|------|
| <b>388-2430C</b> | <b>\$946</b> | <b>\$1,078</b> | <i>\$558</i> | 110 | 15 | 29.5 | 23.75 | 29 | 29.5 |
|------------------|--------------|----------------|--------------|-----|----|------|-------|----|------|

|                  |              |                |              |     |    |      |       |    |      |
|------------------|--------------|----------------|--------------|-----|----|------|-------|----|------|
| <b>388-2436C</b> | <b>\$978</b> | <b>\$1,115</b> | <i>\$572</i> | 125 | 18 | 35.5 | 23.75 | 29 | 29.5 |
|------------------|--------------|----------------|--------------|-----|----|------|-------|----|------|

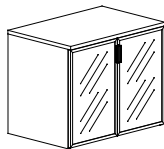

388-2436C-AGD-FR

**\*\* OPTIONAL ALUMINUM GLAZED DOORS \*\***

- SELECT CLEAR (CL), FROSTED (FR) OR BRONZE (BR) PLEXI GLASS  
**EXAMPLE: 388-2436C-AGD-FR**
- AGD DOORS INCLUDE SILVER FINISH BAR HANDLES. PLEASE REFER TO PAGE **100-3** FOR OTHER HANDLE SELECTIONS.
- THE PRICE SHOWN FOR AGD DOORS IS AN UP-CHARGE THAT MUST BE ADDED TO THE BASE PRICE OF THE UNIT IT GOES ON.

# 388/600 STORAGE CABINETS

## CABINET STORAGE

|       | 388  | 600  |           |        |                 |    |    |    | 388 | 600 |
|-------|------|------|-----------|--------|-----------------|----|----|----|-----|-----|
| MODEL | LIST | LIST | AGD       | WEIGHT | CUBE            | W  | D  | H  | H   |     |
|       | 1"   | 1½"  | UP CHARGE | LBS    | FT <sup>3</sup> | IN | IN | 1" | 1½" |     |

### DOUBLE DOOR CABINET - NO TOP

W/ 1 ADJUSTABLE SHELF & 2 LOCKING HINGED DOORS. FITS UNDER CONNECTOR TOP.

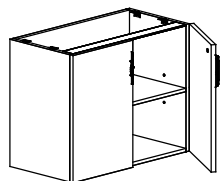

388-1936CX

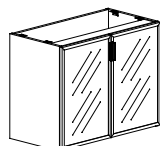

388-1936CX-AGD-BR

|            |       |       |       |     |    |      |       |    |    |
|------------|-------|-------|-------|-----|----|------|-------|----|----|
| 388-1930CX | \$844 | \$844 | \$558 | 85  | 12 | 29.5 | 18.75 | 28 | 28 |
| 388-1936CX | \$871 | \$871 | \$572 | 101 | 15 | 35.5 | 18.75 | 28 | 28 |

### \*\* OPTIONAL ALUMINUM GLAZED DOORS \*\*

- SELECT CLEAR (CL), FROSTED (FR) OR BRONZE (BR) PLEXI GLASS  
**EXAMPLE:** 388-1936CX-AGD-BR
- AGD DOORS INCLUDE SILVER FINISH BAR HANDLES. PLEASE REFER TO PAGE [100-3](#) FOR OTHER HANDLE SELECTIONS.
- THE PRICE SHOWN FOR AGD DOORS IS AN UP-CHARGE THAT MUST BE ADDED TO THE BASE PRICE OF THE UNIT IT GOES ON.

### CABINET - DRAWERS OVER DOORS

20" DEEP W/ 1 ADJUSTABLE SHELF. 2 LOCKING HINGED DOORS.

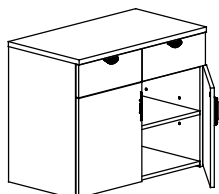

388-2036DC

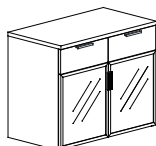

388-2036DC-AGD-FR

|            |         |         |       |     |      |      |       |    |      |
|------------|---------|---------|-------|-----|------|------|-------|----|------|
| 388-2030DC | \$1,233 | \$1,406 | \$519 | 105 | 10.6 | 29.5 | 19.75 | 29 | 29.5 |
| 388-2036DC | \$1,274 | \$1,452 | \$532 | 120 | 12.8 | 35.5 | 19.75 | 29 | 29.5 |

24" DEEP W/ 1 ADJUSTABLE SHELF & 2 LOCKING HINGED DOORS

|            |         |         |       |     |      |      |       |    |      |
|------------|---------|---------|-------|-----|------|------|-------|----|------|
| 388-2430DC | \$1,244 | \$1,418 | \$519 | 126 | 15.5 | 29.5 | 23.75 | 29 | 29.5 |
| 388-2436DC | \$1,368 | \$1,560 | \$532 | 145 | 18.5 | 35.5 | 23.75 | 29 | 29.5 |

### \*\* OPTIONAL ALUMINUM GLAZED DOORS \*\*

- SELECT CLEAR (CL), FROSTED (FR) OR BRONZE (BR) PLEXI GLASS  
**EXAMPLE:** 388-2036DC-AGD-FR
- AGD DOORS INCLUDE SILVER FINISH BAR HANDLES. PLEASE REFER TO PAGE [100-3](#) FOR OTHER HANDLE SELECTIONS.
- THE PRICE SHOWN FOR AGD DOORS IS AN UP-CHARGE THAT MUST BE ADDED TO THE BASE PRICE OF THE UNIT IT GOES ON.

### CABINET - DRAWERS OVER DOORS - NO TOP

W/ 1 ADJUSTABLE SHELF & 2 LOCKING HINGED DOORS. FITS UNDER CONNECTOR TOP.

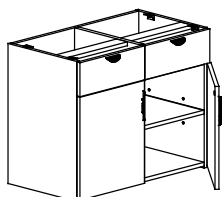

388-1936DCX

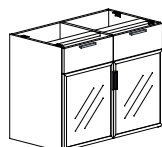

388-1936DCX-AGD-FR

|             |         |         |       |     |      |      |       |    |    |
|-------------|---------|---------|-------|-----|------|------|-------|----|----|
| 388-1930DCX | \$1,204 | \$1,204 | \$519 | 130 | 10.6 | 29.5 | 18.75 | 28 | 28 |
| 388-1936DCX | \$1,248 | \$1,248 | \$532 | 157 | 12.8 | 35.5 | 18.75 | 28 | 28 |

### \*\* OPTIONAL ALUMINUM GLAZED DOORS \*\*

- SELECT CLEAR (CL), FROSTED (FR) OR BRONZE (BR) PLEXI GLASS  
**EXAMPLE:** 388-1936DCX-AGD-FR
- AGD DOORS INCLUDE SILVER FINISH BAR HANDLES. PLEASE REFER TO PAGE [100-3](#) FOR OTHER HANDLE SELECTIONS.
- THE PRICE SHOWN FOR AGD DOORS IS AN UP-CHARGE THAT MUST BE ADDED TO THE BASE PRICE OF THE UNIT IT GOES ON.



| MODEL | 388  |      | 600       |    | AGD | WEIGHT<br>LBS | CUBE<br>FT <sup>3</sup> | W<br>IN | D<br>IN | 388 |  | 600 |  |
|-------|------|------|-----------|----|-----|---------------|-------------------------|---------|---------|-----|--|-----|--|
|       | LIST | LIST | UP CHARGE | H  |     |               |                         |         |         | H   |  |     |  |
|       | 1"   | 1½"  |           | 1" |     |               |                         |         |         | 1½" |  |     |  |

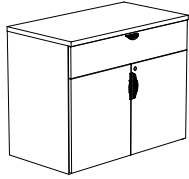

388-2036WDC

**CABINET - WIDE DRAWER OVER 2 DOOR CABINET**

20" DEEP W/ 1 ADJUSTABLE SHELF. 2 LOCKING HINGED DOORS.

|             |         |         |       |     |      |       |       |    |      |
|-------------|---------|---------|-------|-----|------|-------|-------|----|------|
| 388-2030WDC | \$1,275 | \$1,454 | \$519 | 105 | 10.6 | 29.75 | 19.75 | 29 | 29.5 |
| 388-2036WDC | \$1,357 | \$1,547 | \$532 | 120 | 12.8 | 35.5  | 19.75 | 29 | 29.5 |

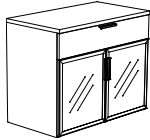

388-2036WDC-AGD-BR

24" DEEP W/ 1 ADJUSTABLE SHELF. 2 LOCKING HINGED DOORS.

|             |         |         |       |     |      |       |       |    |      |
|-------------|---------|---------|-------|-----|------|-------|-------|----|------|
| 388-2430WDC | \$1,302 | \$1,484 | \$519 | 126 | 15.5 | 29.75 | 23.75 | 29 | 29.5 |
| 388-2436WDC | \$1,373 | \$1,565 | \$532 | 145 | 18.5 | 35.5  | 23.75 | 29 | 29.5 |

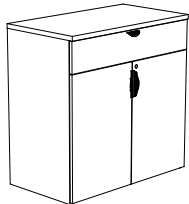

388-2036WDC-36

**36" HIGH CABINET - WIDE DRAWER OVER 2 DOOR CABINET**

20" DEEP W/ 1 ADJUSTABLE SHELF. 2 LOCKING HINGED DOORS.

|                |         |         |       |     |      |       |       |    |      |
|----------------|---------|---------|-------|-----|------|-------|-------|----|------|
| 388-2030WDC-36 | \$1,370 | \$1,562 | \$558 | 115 | 12.7 | 29.75 | 19.75 | 36 | 36.5 |
| 388-2036WDC-36 | \$1,451 | \$1,654 | \$572 | 130 | 15.3 | 35.5  | 19.75 | 36 | 36.5 |

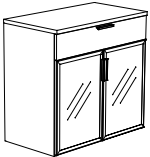

388-2036WDC-36-AGD-BR

24" DEEP W/ 1 ADJUSTABLE SHELF. 2 LOCKING HINGED DOORS.

|                |         |         |       |     |      |       |       |    |      |
|----------------|---------|---------|-------|-----|------|-------|-------|----|------|
| 388-2430WDC-36 | \$1,395 | \$1,590 | \$558 | 136 | 18   | 29.75 | 23.75 | 36 | 36.5 |
| 388-2436WDC-36 | \$1,468 | \$1,674 | \$572 | 155 | 21.5 | 35.5  | 23.75 | 36 | 36.5 |

**\*\* OPTIONAL ALUMINUM GLAZED DOORS \*\***

- SELECT CLEAR (CL), FROSTED (FR) OR BRONZE (BR) PLEXI GLASS  
**EXAMPLE:** 388-2036WDC-AGD-FR
- AGD DOORS INCLUDE SILVER FINISH BAR HANDLES. PLEASE REFER TO PAGE 100-3 FOR OTHER HANDLE SELECTIONS.
- THE PRICE SHOWN FOR AGD DOORS IS AN UP-CHARGE THAT MUST BE ADDED TO THE BASE PRICE OF THE UNIT IT GOES ON.

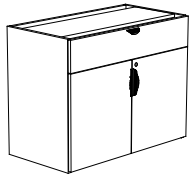

388-1936WDCX

**CABINET - WIDE DRAWER OVER 2 DOOR CABINET - NO TOP**

W/ 1 ADJUSTABLE SHELF & 2 LOCKING HINGED DOORS. FITS UNDER CONNECTOR TOP.

|              |         |         |       |     |      |       |       |    |    |
|--------------|---------|---------|-------|-----|------|-------|-------|----|----|
| 388-1930WDCX | \$1,195 | \$1,195 | \$519 | 102 | 10.6 | 29.75 | 18.75 | 28 | 28 |
| 388-1936WDCX | \$1,275 | \$1,275 | \$532 | 130 | 12.8 | 35.5  | 18.75 | 28 | 28 |

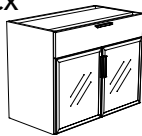

388-1936WDCX

**35" HIGH CABINET - WIDE DRAWER OVER 2 DOOR CABINET - NO TOP**

|                 |         |         |       |     |      |       |       |    |    |
|-----------------|---------|---------|-------|-----|------|-------|-------|----|----|
| 388-1930WDCX-35 | \$1,274 | \$1,274 | \$558 | 112 | 12.8 | 29.75 | 18.75 | 35 | 35 |
| 388-1936WDCX-35 | \$1,357 | \$1,357 | \$572 | 133 | 15.2 | 35.5  | 18.75 | 35 | 35 |

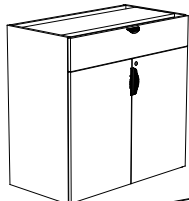

388-1936WDCX-35

**\*\* OPTIONAL ALUMINUM GLAZED DOORS \*\***

- SELECT CLEAR (CL), FROSTED (FR) OR BRONZE (BR) PLEXI GLASS  
**EXAMPLE:** 388-1936WDCX-AGD-FR
- AGD DOORS INCLUDE SILVER FINISH BAR HANDLES. PLEASE REFER TO PAGE 100-3 FOR OTHER HANDLE SELECTIONS.
- THE PRICE SHOWN FOR AGD DOORS IS AN UP-CHARGE THAT MUST BE ADDED TO THE BASE PRICE OF THE UNIT IT GOES ON.

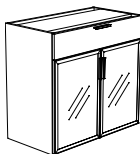

388-1936WDCX-35-AGD-FR

# 388/600 STORAGE CABINETS

## CABINET STORAGE

| MODEL | 388  |      | 600       |           | AGD | WEIGHT<br>LBS | CUBE<br>FT <sup>3</sup> | W<br>IN | D<br>IN | 388 |     | 600 |  |
|-------|------|------|-----------|-----------|-----|---------------|-------------------------|---------|---------|-----|-----|-----|--|
|       | LIST | LIST | UP CHARGE | UP CHARGE |     |               |                         |         |         | H   | H   |     |  |
|       | 1"   | 1½"  |           |           |     |               |                         |         |         | 1"  | 1½" |     |  |

### SINGLE DOOR CABINET

20" DEEP W/ 1 ADJUSTABLE SHELF & LOCKING DOOR HINGED LEFT

|             |       |       |       |    |   |       |       |    |      |
|-------------|-------|-------|-------|----|---|-------|-------|----|------|
| 388-2018CLH | \$784 | \$894 | \$288 | 59 | 6 | 17.75 | 19.75 | 29 | 29.5 |
| 388-2024CLH | \$820 | \$935 | \$330 | 78 | 8 | 23.75 | 19.75 | 29 | 29.5 |

24" DEEP W/ 1 ADJUSTABLE SHELF & LOCKING DOOR HINGED LEFT

|             |       |       |       |    |      |       |       |    |      |
|-------------|-------|-------|-------|----|------|-------|-------|----|------|
| 388-2418CLH | \$834 | \$951 | \$288 | 82 | 9    | 17.75 | 23.75 | 29 | 29.5 |
| 388-2424CLH | \$851 | \$970 | \$330 | 92 | 10.5 | 23.75 | 23.75 | 29 | 29.5 |

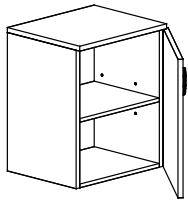

388-2018CRH

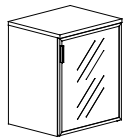

388-2018CRH-AGD-FR

20" DEEP W/ 1 ADJUSTABLE SHELF & LOCKING DOOR HINGED RIGHT

|             |       |       |       |    |   |       |       |    |      |
|-------------|-------|-------|-------|----|---|-------|-------|----|------|
| 388-2018CRH | \$784 | \$894 | \$288 | 59 | 6 | 17.75 | 19.75 | 29 | 29.5 |
| 388-2024CRH | \$820 | \$935 | \$330 | 78 | 8 | 23.75 | 19.75 | 29 | 29.5 |

24" DEEP W/ 1 ADJUSTABLE SHELF & LOCKING DOOR HINGED RIGHT

|             |       |       |       |    |      |       |       |    |      |
|-------------|-------|-------|-------|----|------|-------|-------|----|------|
| 388-2418CRH | \$834 | \$951 | \$288 | 82 | 9    | 17.75 | 23.75 | 29 | 29.5 |
| 388-2424CRH | \$851 | \$970 | \$330 | 92 | 10.5 | 23.75 | 23.75 | 29 | 29.5 |

#### \*\* OPTIONAL ALUMINUM GLAZED DOORS \*\*

- SELECT CLEAR (CL), FROSTED (FR) OR BRONZE (BR) PLEXI GLASS  
**EXAMPLE:** 388-2024CRH-AGD-FR
- AGD DOORS INCLUDE SILVER FINISH BAR HANDLES. PLEASE REFER TO PAGE [100-3](#) FOR OTHER HANDLE SELECTIONS.
- THE PRICE SHOWN FOR AGD DOORS IS AN UP-CHARGE THAT MUST BE ADDED TO THE BASE PRICE OF THE UNIT IT GOES ON.

### SINGLE DOOR CABINET - NO TOP

W/ 1 ADJUSTABLE SHELF. LOCKING DOOR. FITS UNDER WORK SURFACE. HINGED LEFT

|              |       |       |       |    |   |       |       |    |    |
|--------------|-------|-------|-------|----|---|-------|-------|----|----|
| 388-1918CLHX | \$735 | \$735 | \$288 | 49 | 6 | 17.75 | 18.75 | 28 | 28 |
| 388-1924CLHX | \$771 | \$771 | \$330 | 65 | 8 | 23.75 | 18.75 | 28 | 28 |

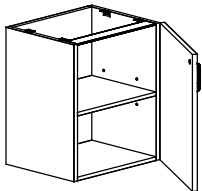

388-1918CRHX

W/ 1 ADJUSTABLE SHELF. LOCKING DOOR. FITS UNDER WORK SURFACE. HINGED RIGHT

|              |       |       |       |    |   |       |       |    |    |
|--------------|-------|-------|-------|----|---|-------|-------|----|----|
| 388-1918CRHX | \$735 | \$735 | \$288 | 49 | 6 | 17.75 | 18.75 | 28 | 28 |
| 388-1924CRHX | \$771 | \$771 | \$330 | 65 | 8 | 23.75 | 18.75 | 28 | 28 |

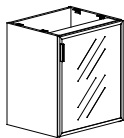

388-1918CRHX-AGD-FR

#### \*\* OPTIONAL ALUMINUM GLAZED DOORS \*\*

- SELECT CLEAR (CL), FROSTED (FR) OR BRONZE (BR) PLEXI GLASS  
**EXAMPLE:** 388-1924CHRHX-AGD-FR
- AGD DOORS INCLUDE SILVER FINISH BAR HANDLES. PLEASE REFER TO PAGE [100-3](#) FOR OTHER HANDLE SELECTIONS.
- THE PRICE SHOWN FOR AGD DOORS IS AN UP-CHARGE THAT MUST BE ADDED TO THE BASE PRICE OF THE UNIT IT GOES ON.

| MODEL | 388  |      | 600       |    | AGD | WEIGHT<br>LBS | CUBE<br>FT <sup>3</sup> | W<br>IN | D<br>IN | 388 |  | 600 |  |
|-------|------|------|-----------|----|-----|---------------|-------------------------|---------|---------|-----|--|-----|--|
|       | LIST | LIST | UP CHARGE | H  |     |               |                         |         |         | H   |  |     |  |
|       | 1"   | 1½"  |           | 1" |     |               |                         |         |         | 1½" |  |     |  |

**CABINET - DRAWER OVER DOOR**

20" DEEP W/ 1 ADJUSTABLE SHELF & LOCKING DOOR HINGED LEFT

|              |         |         |       |    |   |       |       |    |      |
|--------------|---------|---------|-------|----|---|-------|-------|----|------|
| 388-2018DCLH | \$1,010 | \$1,151 | \$277 | 64 | 6 | 17.75 | 19.75 | 29 | 29.5 |
| 388-2024DCLH | \$1,045 | \$1,191 | \$296 | 82 | 8 | 23.75 | 19.75 | 29 | 29.5 |

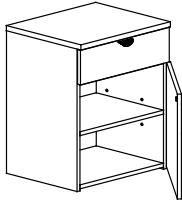

388-2018DCRH

24" DEEP W/ 1 ADJUSTABLE SHELF & LOCKING DOOR HINGED LEFT

|              |         |         |       |    |      |       |       |    |      |
|--------------|---------|---------|-------|----|------|-------|-------|----|------|
| 388-2418DCLH | \$1,030 | \$1,174 | \$277 | 86 | 9    | 17.75 | 23.75 | 29 | 29.5 |
| 388-2424DCLH | \$1,079 | \$1,230 | \$296 | 95 | 10.5 | 23.75 | 23.75 | 29 | 29.5 |

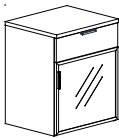

388-2018DCRH-AGD-FR

20" DEEP W/ 1 ADJUSTABLE SHELF & LOCKING DOOR HINGED RIGHT

|              |         |         |       |    |   |       |       |    |      |
|--------------|---------|---------|-------|----|---|-------|-------|----|------|
| 388-2018DCRH | \$1,010 | \$1,151 | \$277 | 64 | 6 | 17.75 | 19.75 | 29 | 29.5 |
| 388-2024DCRH | \$1,045 | \$1,191 | \$296 | 82 | 8 | 23.75 | 19.75 | 29 | 29.5 |

24" DEEP W/ 1 ADJUSTABLE SHELF & LOCKING DOOR HINGED RIGHT

|              |         |         |       |    |      |       |       |    |      |
|--------------|---------|---------|-------|----|------|-------|-------|----|------|
| 388-2418DCRH | \$1,030 | \$1,174 | \$277 | 86 | 9    | 17.75 | 23.75 | 29 | 29.5 |
| 388-2424DCRH | \$1,079 | \$1,230 | \$296 | 95 | 10.5 | 23.75 | 23.75 | 29 | 29.5 |

**\*\* OPTIONAL ALUMINUM GLAZED DOORS \*\***

- SELECT CLEAR (CL), FROSTED (FR) OR BRONZE (BR) PLEXI GLASS  
**EXAMPLE:** 388-2024CRH-AGD-FR
- AGD DOORS INCLUDE SILVER FINISH BAR HANDLES. PLEASE REFER TO PAGE [100-3](#) FOR OTHER HANDLE SELECTIONS.
- THE PRICE SHOWN FOR AGD DOORS IS AN UP-CHARGE THAT MUST BE ADDED TO THE BASE PRICE OF THE UNIT IT GOES ON.

**CABINET - DRAWER OVER DOOR - NO TOP**

W/ 1 ADJUSTABLE SHELF. LOCKING DOOR. FITS UNDER WORK SURFACE. HINGED LEFT

|               |       |       |       |    |   |       |       |    |    |
|---------------|-------|-------|-------|----|---|-------|-------|----|----|
| 388-1918DCLHX | \$960 | \$960 | \$277 | 54 | 6 | 17.75 | 18.75 | 28 | 28 |
| 388-1924DCLHX | \$997 | \$997 | \$296 | 70 | 8 | 23.75 | 18.75 | 28 | 28 |

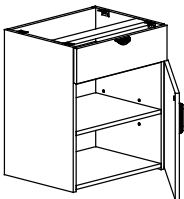

388-1918DCRHX

W/ 1 ADJUSTABLE SHELF. LOCKING DOOR. FITS UNDER WORK SURFACE. HINGED RIGHT

|               |       |       |       |    |   |       |       |    |    |
|---------------|-------|-------|-------|----|---|-------|-------|----|----|
| 388-1918DCRHX | \$960 | \$960 | \$277 | 54 | 6 | 17.75 | 18.75 | 28 | 28 |
| 388-1924DCRHX | \$997 | \$997 | \$296 | 70 | 8 | 23.75 | 18.75 | 28 | 28 |

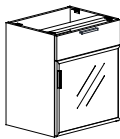

388-1918DCRHX-AGD-FR

**\*\* OPTIONAL ALUMINUM GLAZED DOORS \*\***

- SELECT CLEAR (CL), FROSTED (FR) OR BRONZE (BR) PLEXI GLASS  
**EXAMPLE:** 388-1924DCRHX-AGD-FR
- AGD DOORS INCLUDE SILVER FINISH BAR HANDLES. PLEASE REFER TO PAGE [100-3](#) FOR OTHER HANDLE SELECTIONS.
- THE PRICE SHOWN FOR AGD DOORS IS AN UP-CHARGE THAT MUST BE ADDED TO THE BASE PRICE OF THE UNIT IT GOES ON.

# 388/600 STORAGE CABINETS

## OPEN CABINET STORAGE

|       | 388  | 600  |        |                 |    |    | 388 | 600 |
|-------|------|------|--------|-----------------|----|----|-----|-----|
| MODEL | LIST | LIST | WEIGHT | CUBE            | W  | D  | H   | H   |
|       | 1"   | 1½"  | LBS    | FT <sup>3</sup> | IN | IN | 1"  | 1½" |

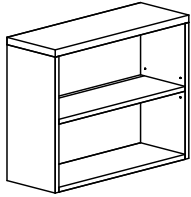

### OPEN CABINET

13" DEEP. W/ 1 ADJUSTABLE SHELF.

|            |       |       |    |    |      |    |    |      |
|------------|-------|-------|----|----|------|----|----|------|
| 388-1330CO | \$762 | \$869 | 68 | 10 | 29.5 | 13 | 29 | 29.5 |
| 388-1336CO | \$779 | \$888 | 76 | 12 | 35.5 | 13 | 29 | 29.5 |

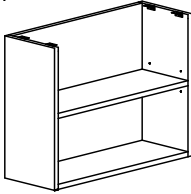

### OPEN CABINET - NO TOP

13" DEEP. W/ 1 ADJUSTABLE SHELF. FITS UNDER CONNECTOR TOP.

|             |       |       |    |    |      |    |    |    |
|-------------|-------|-------|----|----|------|----|----|----|
| 388-1330COX | \$712 | \$712 | 60 | 17 | 29.5 | 13 | 28 | 28 |
| 388-1336COX | \$741 | \$741 | 67 | 19 | 35.5 | 13 | 28 | 28 |

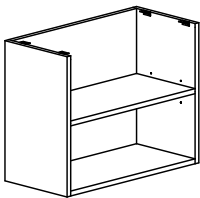

### OPEN CABINET - NO TOP

17" DEEP. W/ 1 ADJUSTABLE SHELF. FITS UNDER CONNECTOR TOP.

|             |       |       |    |    |      |       |    |    |
|-------------|-------|-------|----|----|------|-------|----|----|
| 388-1730COX | \$792 | \$792 | 67 | 13 | 29.5 | 16.75 | 28 | 28 |
| 388-1736COX | \$820 | \$820 | 78 | 16 | 35.5 | 16.75 | 28 | 28 |

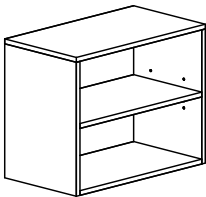

### OPEN CABINET

20" DEEP. W/ 1 ADJUSTABLE SHELF.

|            |       |       |    |    |      |       |    |      |
|------------|-------|-------|----|----|------|-------|----|------|
| 388-2030CO | \$820 | \$935 | 87 | 14 | 29.5 | 19.75 | 29 | 29.5 |
| 388-2036CO | \$864 | \$985 | 99 | 16 | 35.5 | 19.75 | 29 | 29.5 |

24" DEEP. W/ 1 ADJUSTABLE SHELF.

|            |       |         |     |    |      |       |    |      |
|------------|-------|---------|-----|----|------|-------|----|------|
| 388-2430CO | \$888 | \$1,012 | 105 | 17 | 29.5 | 23.75 | 29 | 29.5 |
| 388-2436CO | \$921 | \$1,050 | 119 | 19 | 35.5 | 23.75 | 29 | 29.5 |

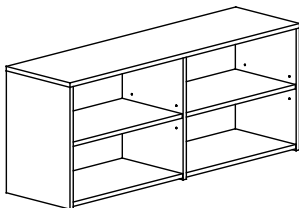

### OPEN CABINET W/ DIVIDER

20" DEEP. W/ 2 ADJUSTABLE SHELVES.

|            |         |         |     |    |       |       |    |      |
|------------|---------|---------|-----|----|-------|-------|----|------|
| 388-2060CO | \$1,504 | \$1,715 | 210 | 26 | 59.25 | 19.75 | 29 | 29.5 |
| 388-2072CO | \$1,604 | \$1,829 | 230 | 29 | 71    | 19.75 | 29 | 29.5 |

24" DEEP W/ 2 ADJUSTABLE SHELVES

|            |         |         |     |    |       |       |    |      |
|------------|---------|---------|-----|----|-------|-------|----|------|
| 388-2460CO | \$1,638 | \$1,867 | 225 | 28 | 59.25 | 23.75 | 29 | 29.5 |
| 388-2472CO | \$1,682 | \$1,917 | 245 | 31 | 71    | 23.75 | 29 | 29.5 |

| MODEL | 388  | 600  | AGD       | WEIGHT | CUBE            | W  | D  | 388 | 600 |
|-------|------|------|-----------|--------|-----------------|----|----|-----|-----|
|       | LIST | LIST |           |        |                 |    |    | H   | H   |
|       | 1"   | 1½"  | UP CHARGE | LBS    | FT <sup>3</sup> | IN | IN | 1"  | 1½" |

**MOBILE OPEN CABINET**

20" DEEP



|             |       |         |     |     |    |      |       |    |      |
|-------------|-------|---------|-----|-----|----|------|-------|----|------|
| 388-2030MCO | \$863 | \$984   | N/A | 91  | 13 | 29.5 | 19.75 | 29 | 29.5 |
| 388-2036MCO | \$900 | \$1,026 | N/A | 105 | 15 | 35.5 | 19.75 | 29 | 29.5 |
| 24" DEEP    |       |         |     |     |    |      |       |    |      |
| 388-2430MCO | \$934 | \$1,065 | N/A | 109 | 15 | 29.5 | 23.75 | 29 | 29.5 |
| 388-2436MCO | \$962 | \$1,097 | N/A | 112 | 18 | 35.5 | 23.75 | 29 | 29.5 |

- W/ 1 ADJUSTABLE SHELF
- HEAVY DUTY LOCKING WHEELS
- MAXIMUM WEIGHT CAPACITY OF 400LBS

**MOBILE CABINET W/ HINGED DOORS**

20" DEEP

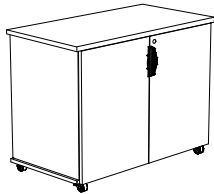

|            |         |         |       |     |    |      |       |    |      |
|------------|---------|---------|-------|-----|----|------|-------|----|------|
| 388-2030MC | \$1,111 | \$1,267 | \$558 | 105 | 13 | 29.5 | 19.75 | 29 | 29.5 |
| 388-2036MC | \$1,138 | \$1,297 | \$572 | 120 | 15 | 35.5 | 19.75 | 29 | 29.5 |
| 24" DEEP   |         |         |       |     |    |      |       |    |      |
| 388-2430MC | \$1,123 | \$1,280 | \$558 | 115 | 15 | 29.5 | 23.75 | 29 | 29.5 |
| 388-2436MC | \$1,182 | \$1,347 | \$572 | 130 | 16 | 35.5 | 23.75 | 29 | 29.5 |

- W/ 1 ADJUSTABLE SHELF
- HEAVY DUTY LOCKING WHEELS
- MAXIMUM WEIGHT CAPACITY OF 400LBS

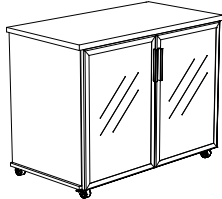

**\*\* OPTIONAL ALUMINUM GLAZED DOORS \*\***

- SELECT CLEAR (CL), FROSTED (FR) OR BRONZE (BR) PLEXI GLASS
- **EXAMPLE:** 388-2024CRH-AGD-FR
- AGD DOORS INCLUDE SILVER FINISH BAR HANDLES. PLEASE REFER TO PAGE 100-3 FOR OTHER HANDLE SELECTIONS.
- THE PRICE SHOWN FOR AGD DOORS IS AN UP-CHARGE THAT MUST BE ADDED TO THE BASE PRICE OF THE UNIT IT GOES ON.

**MOBILE STORAGE OPEN**



|                |       |     |     |      |     |       |    |    |     |
|----------------|-------|-----|-----|------|-----|-------|----|----|-----|
| 388-1320MSO-22 | \$743 | N/A | N/A | 25.2 | 3.2 | 19.75 | 13 | 22 | N/A |
|----------------|-------|-----|-----|------|-----|-------|----|----|-----|

- WITH 2 LOCKING & 2 NON-LOCKING CASTORS

**FILE CABINET TOP**

W/ MATCHING 2MM EDGE BAND. HARDWARE NOT INCLUDED.

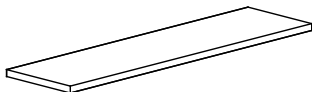

RTA

|            |       |       |     |      |     |      |       |   |     |
|------------|-------|-------|-----|------|-----|------|-------|---|-----|
| 388-1936FC | \$204 | \$335 | N/A | 18   | 1   | 35.5 | 18.75 | 1 | 1.5 |
| 388-1972FC | \$361 | \$398 | N/A | 36.5 | 1.1 | 71   | 18.75 | 1 | 1.5 |
| 388-1996FC | \$518 | \$582 | N/A | 48.6 | 1.5 | 94.5 | 18.75 | 1 | 1.5 |

- IF A SMALLER DEPTH IS REQUIRED, SIMPLY CHANGE MODEL NUMBER FROM 19 (DEPTH) TO DESIRED SIZE. (PRICE REMAINS UNCHANGED) EXAMPLE: 388-1772FC = \$361 FOR INTERMEDIATE SIZES, USE PRICE OF NEXT SIZE UP.

**EXAMPLE 1:**  
388-1936FC  
388-1936OLFX

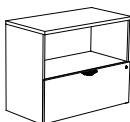

**EXAMPLE 2:**  
388-1972FC  
388-1936LFX  
388-1936CX



**EXAMPLE 3:**  
388-1996FC  
388-1936CX x 2  
388-1924DCRHx

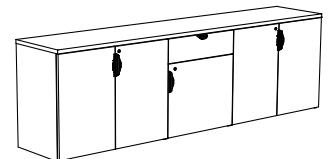

# 388/600 BOARDROOM-HEIGHT STORAGE CABINETS

|       | 388  | 600  |           |        |                 |    |    |    | 388 | 600 |
|-------|------|------|-----------|--------|-----------------|----|----|----|-----|-----|
| MODEL | LIST | LIST | AGD       | WEIGHT | CUBE            | W  | D  | H  | H   | H   |
|       | 1"   | 1½"  | UP CHARGE | LBS    | FT <sup>3</sup> | IN | IN | 1" | 1½" |     |

**NEW!** BOARDROOM HEIGHT CABINET W/ HINGED DOORS - NO TOP

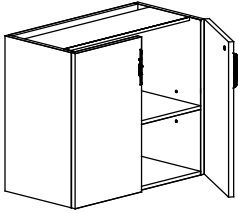

20" DEEP.

|               |       |       |       |     |      |       |       |    |    |
|---------------|-------|-------|-------|-----|------|-------|-------|----|----|
| 388-2030CX-35 | \$967 | \$967 | \$710 | 96  | 13.5 | 29.75 | 19.75 | 35 | 35 |
| 388-2036CX-35 | \$997 | \$997 | \$726 | 115 | 16.1 | 35.5  | 19.75 | 35 | 35 |

24" DEEP.

|               |         |         |       |     |      |       |       |    |    |
|---------------|---------|---------|-------|-----|------|-------|-------|----|----|
| 388-2430CX-35 | \$1,023 | \$1,023 | \$710 | 116 | 16.2 | 29.75 | 23.75 | 35 | 35 |
| 388-2436CX-35 | \$1,046 | \$1,046 | \$726 | 138 | 19.3 | 35.5  | 23.75 | 35 | 35 |

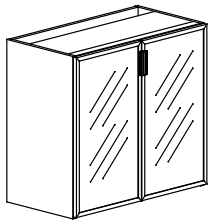

- W/ 1 ADJUSTABLE SHELF & 2 LOCKING HINGED DOORS.

**\*\* OPTIONAL ALUMINUM GLAZED DOORS \*\***

- SELECT CLEAR (CL), FROSTED (FR) OR BRONZE (BR) PLEXI GLASS  
**EXAMPLE:** 388-2030CX-35-AGD-FR
- AGD DOORS INCLUDE SILVER FINISH BAR HANDLES. PLEASE REFER TO PAGE [100-3](#) FOR OTHER HANDLE SELECTIONS.
- THE PRICE SHOWN FOR AGD DOORS IS AN UP-CHARGE THAT MUST BE ADDED TO THE BASE PRICE OF THE UNIT IT GOES ON.

**NEW!** BOARDROOM HEIGHT CABINET W/ DRAWER OVER DOORS - NO TOP

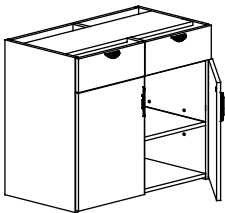

20" DEEP.

|                |         |         |       |     |      |       |       |    |    |
|----------------|---------|---------|-------|-----|------|-------|-------|----|----|
| 388-2030DCX-35 | \$1,362 | \$1,362 | \$558 | 118 | 13.5 | 29.75 | 19.75 | 35 | 35 |
| 388-2036DCX-35 | \$1,445 | \$1,445 | \$572 | 141 | 16.1 | 35.5  | 19.75 | 35 | 35 |

24" DEEP.

|                |         |         |       |     |      |       |       |    |    |
|----------------|---------|---------|-------|-----|------|-------|-------|----|----|
| 388-2430DCX-35 | \$1,450 | \$1,450 | \$558 | 142 | 16.2 | 29.75 | 23.75 | 35 | 35 |
| 388-2436DCX-35 | \$1,482 | \$1,482 | \$572 | 169 | 19.3 | 35.5  | 23.75 | 35 | 35 |

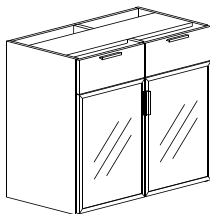

- W/ 1 ADJUSTABLE SHELF & 2 LOCKING HINGED DOORS.

**\*\* OPTIONAL ALUMINUM GLAZED DOORS \*\***

- SELECT CLEAR (CL), FROSTED (FR) OR BRONZE (BR) PLEXI GLASS  
**EXAMPLE:** 388-2030DCX-35-AGD-FR
- AGD DOORS INCLUDE SILVER FINISH BAR HANDLES. PLEASE REFER TO PAGE [100-3](#) FOR OTHER HANDLE SELECTIONS.
- THE PRICE SHOWN FOR AGD DOORS IS AN UP-CHARGE THAT MUST BE ADDED TO THE BASE PRICE OF THE UNIT IT GOES ON.

| MODEL | 388  |      | 600       |      | AGD | WEIGHT<br>LBS | CUBE<br>FT <sup>3</sup> | W<br>IN | D<br>IN | 388 |     | 600 |  |
|-------|------|------|-----------|------|-----|---------------|-------------------------|---------|---------|-----|-----|-----|--|
|       | LIST | LIST | LIST      | LIST |     |               |                         |         |         | H   | H   |     |  |
|       | 1"   | 1½"  | UP CHARGE |      |     |               |                         |         |         | 1"  | 1½" |     |  |

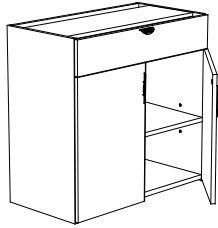

**NEW!**

**BOARDROOM HEIGHT CABINET W/ WIDE DRAWER - NO TOP**

20" DEEP.

|                 |                |                |              |     |      |       |       |    |    |
|-----------------|----------------|----------------|--------------|-----|------|-------|-------|----|----|
| 388-2030WDCX-35 | <b>\$1,274</b> | <b>\$1,274</b> | <i>\$558</i> | 118 | 13.5 | 29.75 | 19.75 | 35 | 35 |
| 388-2036WDCX-35 | <b>\$1,357</b> | <b>\$1,357</b> | <i>\$572</i> | 141 | 16.1 | 35.5  | 19.75 | 35 | 35 |

24" DEEP.

|                 |                |                |              |     |      |       |       |    |    |
|-----------------|----------------|----------------|--------------|-----|------|-------|-------|----|----|
| 388-2430WDCX-35 | <b>\$1,405</b> | <b>\$1,405</b> | <i>\$558</i> | 142 | 16.2 | 29.75 | 23.75 | 35 | 35 |
| 388-2436WDCX-35 | <b>\$1,452</b> | <b>\$1,452</b> | <i>\$572</i> | 169 | 19.3 | 35.5  | 23.75 | 35 | 35 |

- W/ 1 ADJUSTABLE SHELF & 2 LOCKING HINGED DOORS.

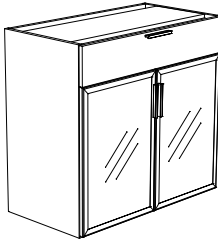

**\*\* OPTIONAL ALUMINUM GLAZED DOORS \*\***

- SELECT CLEAR (CL), FROSTED (FR) OR BRONZE (BR) PLEXI GLASS  
**EXAMPLE:** 388-2030WDCX-35-AGD-FR
- AGD DOORS INCLUDE SILVER FINISH BAR HANDLES. PLEASE REFER TO PAGE **100-3** FOR OTHER HANDLE SELECTIONS.
- THE PRICE SHOWN FOR AGD DOORS IS AN UP-CHARGE THAT MUST BE ADDED TO THE BASE PRICE OF THE UNIT IT GOES ON.

**FILE CABINET TOP**

W/ MATCHING 2MM EDGE BAND. HARDWARE NOT INCLUDED

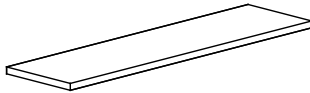

**RTA**

|            |              |              |     |      |     |       |       |   |     |
|------------|--------------|--------------|-----|------|-----|-------|-------|---|-----|
| 388-2060FC | <b>\$337</b> | <b>\$404</b> | N/A | 30.5 | 1   | 59.25 | 19.75 | 1 | 1.5 |
| 388-2066FC | <b>\$353</b> | <b>\$424</b> | N/A | 33.4 | 1.1 | 65    | 19.75 | 1 | 1.5 |
| 388-2072FC | <b>\$361</b> | <b>\$398</b> | N/A | 36.5 | 1.1 | 71    | 19.75 | 1 | 1.5 |
| 388-2090FC | <b>\$461</b> | <b>\$553</b> | N/A | 45.6 | 1.4 | 88.75 | 19.75 | 1 | 1.5 |
| 388-2096FC | <b>\$518</b> | <b>\$582</b> | N/A | 48.6 | 1.5 | 94.5  | 19.75 | 1 | 1.5 |
| 388-2460FC | <b>\$348</b> | <b>\$418</b> | N/A | 36.6 | 1.1 | 59.25 | 23.75 | 1 | 1.5 |
| 388-2466FC | <b>\$363</b> | <b>\$436</b> | N/A | 40.2 | 1.2 | 65    | 23.75 | 1 | 1.5 |
| 388-2472FC | <b>\$371</b> | <b>\$445</b> | N/A | 43.9 | 1.4 | 71    | 23.75 | 1 | 1.5 |
| 388-2490FC | <b>\$471</b> | <b>\$565</b> | N/A | 54.9 | 1.7 | 88.75 | 23.75 | 1 | 1.5 |
| 388-2496FC | <b>\$528</b> | <b>\$634</b> | N/A | 58.4 | 1.8 | 94.5  | 23.75 | 1 | 1.5 |

**EXAMPLE 1:**  
388-2072FC  
388-2036CX-35 x 2

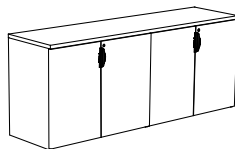

**EXAMPLE 2:**  
388-2096FC  
388-2030CX-35 x 2  
388-2036DCX-35

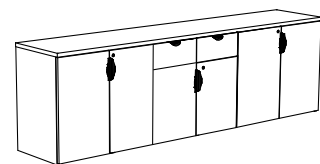

# 388/600 MID-HEIGHT STORAGE CABINETS

| MODEL | 388  |      | 600       |     | AGD | WEIGHT | CUBE | W | D | 388             |    | 600 |   |   |
|-------|------|------|-----------|-----|-----|--------|------|---|---|-----------------|----|-----|---|---|
|       | LIST | LIST | UP CHARGE | LBS |     |        |      |   |   | FT <sup>3</sup> | IN | IN  | H | H |
|       | 1"   | 1½"  |           |     |     |        |      |   |   |                 | 1" | 1½" |   |   |

## MID HEIGHT CABINETS

20" DEEP

1 FIXED SHELF, 2 ADJUSTABLE SHELVES & LOCKING CABINET

|              |         |         |         |     |    |      |       |       |       |
|--------------|---------|---------|---------|-----|----|------|-------|-------|-------|
| 388-4230C-20 | \$1,123 | \$1,190 | \$846   | 165 | 19 | 29.5 | 19.75 | 42    | 42    |
| 388-4236C-20 | \$1,222 | \$1,295 | \$952   | 185 | 22 | 35.5 | 19.75 | 42    | 42    |
| 388-4730C-20 | \$1,262 | \$1,338 | \$863   | 182 | 21 | 29.5 | 19.75 | 46.75 | 46.75 |
| 388-4736C-20 | \$1,358 | \$1,439 | \$1,019 | 200 | 24 | 35.5 | 19.75 | 46.75 | 46.75 |

24" DEEP

1 FIXED SHELF, 2 ADJUSTABLE SHELVES & LOCKING CABINET

|              |         |         |         |     |    |      |       |       |       |
|--------------|---------|---------|---------|-----|----|------|-------|-------|-------|
| 388-4230C-24 | \$1,407 | \$1,491 | \$846   | 181 | 23 | 29.5 | 23.75 | 42    | 42    |
| 388-4236C-24 | \$1,437 | \$1,523 | \$952   | 205 | 25 | 35.5 | 23.75 | 42    | 42    |
| 388-4730C-24 | \$1,408 | \$1,492 | \$863   | 201 | 24 | 29.5 | 23.75 | 46.75 | 46.75 |
| 388-4736C-24 | \$1,522 | \$1,613 | \$1,019 | 220 | 26 | 35.5 | 23.75 | 46.75 | 46.75 |

### \*\* OPTIONAL ALUMINUM GLAZED DOORS \*\*

- SELECT CLEAR (CL), FROSTED (FR) OR BRONZE (BR) PLEXI GLASS

**EXAMPLE:** 388-4936C-AGD-FR

- AGD DOORS INCLUDE SILVER FINISH BAR HANDLES. PLEASE REFER TO PAGE 100-3 FOR OTHER HANDLE SELECTIONS.
- THE PRICE SHOWN FOR AGD DOORS IS AN UP-CHARGE THAT MUST BE ADDED TO THE BASE PRICE OF THE UNIT IT GOES ON.

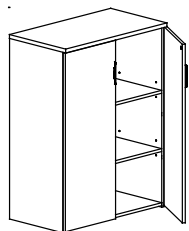

388-4736C-20

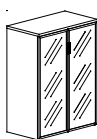

388-4736C-20-AGD-FR

## OPEN MID-HEIGHT CABINET

20" DEEP

1 FIXED SHELF & 2 ADJUSTABLE SHELVES

|               |         |         |     |     |    |       |       |       |       |
|---------------|---------|---------|-----|-----|----|-------|-------|-------|-------|
| 388-4230CO-20 | \$1,113 | \$1,180 | N/A | 180 | 19 | 29.5  | 19.75 | 42    | 42    |
| 388-4236CO-20 | \$1,150 | \$1,219 | N/A | 187 | 22 | 35.5  | 19.75 | 42    | 42    |
| 388-4718CO-20 | \$1,012 | \$1,073 | N/A | 155 | 16 | 17.75 | 19.75 | 46.75 | 46.75 |
| 388-4724CO-20 | \$1,118 | \$1,185 | N/A | 172 | 18 | 23.75 | 19.75 | 46.75 | 46.75 |
| 388-4730CO-20 | \$1,158 | \$1,227 | N/A | 192 | 20 | 29.5  | 19.75 | 46.75 | 46.75 |
| 388-4736CO-20 | \$1,233 | \$1,307 | N/A | 200 | 22 | 35.5  | 19.75 | 46.75 | 46.75 |

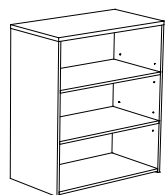

388-4236CO-20

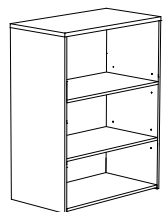

388-4736CO-24

24" DEEP

1 FIXED SHELF & 2 ADJUSTABLE SHELVES

|               |         |         |     |     |    |       |       |       |       |
|---------------|---------|---------|-----|-----|----|-------|-------|-------|-------|
| 388-4230CO-24 | \$1,205 | \$1,277 | N/A | 195 | 20 | 29.5  | 23.75 | 42    | 42    |
| 388-4236CO-24 | \$1,244 | \$1,319 | N/A | 202 | 24 | 35.5  | 23.75 | 42    | 42    |
| 388-4718CO-24 | \$1,108 | \$1,174 | N/A | 160 | 18 | 17.75 | 23.75 | 46.75 | 46.75 |
| 388-4724CO-24 | \$1,214 | \$1,287 | N/A | 187 | 20 | 23.75 | 23.75 | 46.75 | 46.75 |
| 388-4730CO-24 | \$1,251 | \$1,326 | N/A | 207 | 22 | 29.5  | 23.75 | 46.75 | 46.75 |
| 388-4736CO-24 | \$1,327 | \$1,407 | N/A | 215 | 24 | 35.5  | 23.75 | 46.75 | 46.75 |



| MODEL | 388  |      | 600       |        | AGD | WEIGHT<br>LBS | CUBE<br>FT <sup>3</sup> | W<br>IN | D<br>IN | 388             |    | 600 |    |     |
|-------|------|------|-----------|--------|-----|---------------|-------------------------|---------|---------|-----------------|----|-----|----|-----|
|       | LIST | LIST | AGD       | WEIGHT |     |               |                         |         |         | CUBE            | W  | D   | H  | H   |
|       | 1"   | 1½"  | UP CHARGE | LBS    |     |               |                         |         |         | FT <sup>3</sup> | IN | IN  | 1" | 1½" |

**MID-HEIGHT CLOSET CABINET**

INCLUDES COAT ROD. DRILLED FOR OPTIONAL BOOT SHELF. LOCKING.

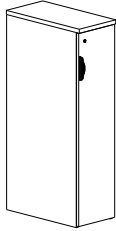

388-4712MCL24-R

HINGED LEFT

388-4712MCL24-L **\$989** **\$1,127** *\$438* 74 8.7 11.75 23.75 **46.75** 46.75

388-4724MCL24-L **\$1,385** **\$1,468** *\$544* 90 16.9 23.75 23.75 **46.75** 46.75

HINGED RIGHT (SHOWN)

388-4712MCL24-R **\$989** **\$1,127** *\$438* 74 8.7 11.75 23.75 **46.75** 46.75

388-4724MCL24-R **\$1,385** **\$1,468** *\$544* 90 16.9 23.75 23.75 **46.75** 46.75

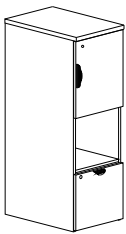

388-4716COF24-R

**MID-HEIGHT CABINET/ OPEN/FILE DRAWER CABINET**

FILE DRAWER & CABINET LOCK. 2 FIXED SHELVES & 1 ADJUSTABLE SHELF.

HINGED LEFT

388-4716COF24-L **\$897** **\$951** *\$438* 79 11.4 15.75 23.75 **46.75** 46.75

HINGED RIGHT (SHOWN)

388-4716COF24-R **\$897** **\$951** *\$438* 79 11.4 15.75 23.75 **46.75** 46.75

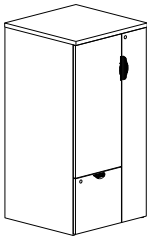

388-4724CFWR-24

**MID-HEIGHT WARDROBE STORAGE**

INCLUDES COAT ROD, 1 FIXED SHELF & 1 ADJUSTABLE SHELF. WARDROBE & FILE DRAWER ARE LOCKING. OPTIONAL LOCK ON CABINET DOOR.

CABINET/FILE WARDROBE LEFT

388-4724CFWL-24 **\$1,594** **\$1,690** *\$762* 202 16.9 23.75 23.75 **46.75** 46.75

CABINET/FILE WARDROBE RIGHT (SHOWN)

388-4724CFWR-24 **\$1,594** **\$1,690** *\$762* 202 16.9 23.75 23.75 **46.75** 46.75

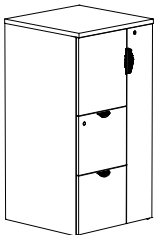

388-4724CFFWR-24

**MID-HEIGHT WARDROBE STORAGE**

INCLUDES COAT ROD, 1 FIXED SHELF & 1 ADJUSTABLE SHELF. WARDROBE & FILE DRAWERS ARE LOCKING. OPTIONAL LOCK ON CABINET DOOR.

CABINET/FILE/FILE/WARDROBE LEFT

388-4724CFFWL-24 **\$1,650** **\$1,749** *\$544* 225 16.9 23.75 23.75 **46.75** 46.75

CABINET/FILE/FILE/WARDROBE RIGHT (SHOWN)

388-4724CFFWR-24 **\$1,650** **\$1,749** *\$544* 225 16.9 23.75 23.75 **46.75** 46.75

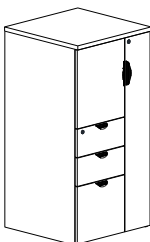

388-4724CUFWR-24

**MID-HEIGHT WARDROBE STORAGE**

INCLUDES COAT ROD, 1 FIXED SHELF & 1 ADJUSTABLE SHELF. WARDROBE & DRAWERS ARE LOCKING. OPTIONAL LOCK ON CABINET DOOR.

CABINET/BOX/BOX/FILE WARDROBE RIGHT

388-4724CUFWL-24 **\$1,658** **\$1,757** *\$544* 225 16.9 23.75 23.75 **46.75** 46.75

CABINET/BOX/BOX/FILE WARDROBE LEFT (SHOWN)

388-4724CUFWR-24 **\$1,658** **\$1,757** *\$544* 225 16.9 23.75 23.75 **46.75** 46.75

# 388/600 MID-HEIGHT CLOSET STORAGE CABINETS

| MODEL | 388  |      | 600       |     | AGD | WEIGHT | CUBE | W | D | 388             |    | 600 |   |   |
|-------|------|------|-----------|-----|-----|--------|------|---|---|-----------------|----|-----|---|---|
|       | LIST | LIST | UP CHARGE | LBS |     |        |      |   |   | FT <sup>3</sup> | IN | IN  | H | H |
|       | 1"   | 1½"  |           |     |     |        |      |   |   |                 | 1" | 1½" |   |   |

## MID-HEIGHT WARDROBE STORAGE

INCLUDES COAT ROD. LOCKING CABINET & WARDROBE.  
CABINET CONTAINS 1 FIXED SHELF & 2 ADJUSTABLE SHELVES.

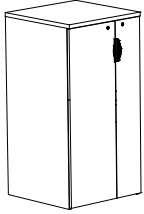

388-4724CWR-24

CABINET/WARDROBE LEFT

**388-4724CWL-24**    **\$1,551**    **\$1,644**    \$778    **150**    **16.9**    **23.75**    **23.75**    **46.75**    **46.75**

CABINET/WARDROBE RIGHT (SHOWN)

**388-4724CWR-24**    **\$1,551**    **\$1,644**    \$778    **150**    **16.9**    **23.75**    **23.75**    **46.75**    **46.75**

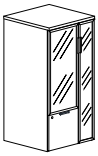

388-4724CFWR-24-AGD-FR

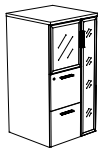

388-4724CFWR-24-AGD-FR

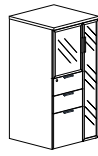

388-4724CUFWR-24-AGD-FR

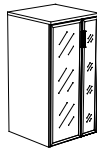

388-4724CWR-24-AGD-FR

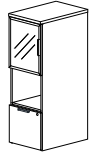

388-4816COF24-L-AGD-FR

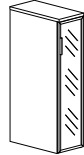

388-4712MCL24-R-AGD-FR

- DOOR LOCK OPTIONAL, ADD AN '-L' TO ITEM # & ADD UPCHARGE OF \$76  
**EXAMPLE:** 388-4716COF24-L-L
- TO ADD BOOTSHelf, ADD -BS TO SKU. UP-CHARGES APPLY SEE BELOW
- **\*OPTIONAL ALUMINUM GLAZED DOORS\***
- SELECT CLEAR (CL), FROSTED (FR) OR BRONZE (BR) PLEXI GLASS
- AGD DOORS INCLUDE SILVER FINISH BAR HANDLES. REFER TO **100-3** FOR OTHER HANDLE OPTIONS
- THE PRICE SHOWN FOR AGD DOORS IS AN UP-CHARGE THAT MUST BE ADDED TO THE BASE PRICE OF THE UNIT IT GOES ON.

## OPTIONAL BOOT SHELVES

All tall & mid-height wardrobe storage & storage cabinets can have an optional boot shelf.  
Upcharges apply when ordering bootshelf: add **-BS** to product SKU.

> **Ordering Example:** 388-4724CWR-24-BS

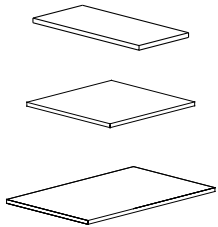

| Bootshelf Upcharges |              |
|---------------------|--------------|
| 12" w to 23" w      | <b>\$119</b> |
| 24" w to 35" w      | <b>\$134</b> |
| 36" w or >          | <b>\$174</b> |

| MODEL | 388  |      | 600       |  | AGD | WEIGHT<br>LBS | CUBE<br>FT <sup>3</sup> | W<br>IN | D<br>IN | 388 |     | 600 |  |
|-------|------|------|-----------|--|-----|---------------|-------------------------|---------|---------|-----|-----|-----|--|
|       | LIST | LIST | UP CHARGE |  |     |               |                         |         |         | H   | H   |     |  |
|       | 1"   | 1½"  |           |  |     |               |                         |         |         | 1"  | 1½" |     |  |

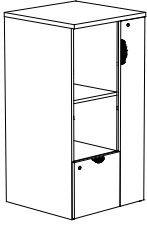

388-4724OFWR-24

**MID-HEIGHT OPEN WARDROBE STORAGE**

INCLUDES COAT ROD & HAT SHELF. LOCKING FILE DRAWER & WARDROBE. 1 FIXED SHELF & 1 ADJUSTABLE SHELF IN CABINET.

OPEN SHELF/FILE/WARDROBE LEFT

**388-4724OFWL-24**    **\$1,562**    **\$1,656**    \$544    **162**    **16.9**    **23.75**    **23.75**    **46.75**    **46.75**

OPEN SHELF/FILE/WARDROBE RIGHT

**388-4724OFWR-24**    **\$1,562**    **\$1,656**    \$544    **162**    **16.9**    **23.75**    **23.75**    **46.75**    **46.75**

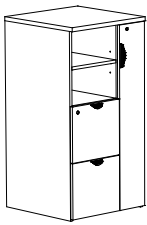

388-4724OFFWR-24

**MID-HEIGHT OPEN WARDROBE STORAGE**

INCLUDES COAT ROD, 1 FIXED SHELF & 1 ADJUSTABLE SHELF. WARDROBE & DRAWERS ARE LOCKING.. 1 FIXED SHELF & 1 ADJUSTABLE SHELF

OPEN SHELF/FILE/FILE/WARDROBE LEFT

**388-4724OFFWL-24**    **\$1,613**    **\$1,710**    \$544    **189**    **16.9**    **23.75**    **23.75**    **46.75**    **46.75**

OPEN SHELF/FILE/FILE/WARDROBE RIGHT

**388-4724OFFWR-24**    **\$1,613**    **\$1,710**    \$544    **189**    **16.9**    **23.75**    **23.75**    **46.75**    **46.75**

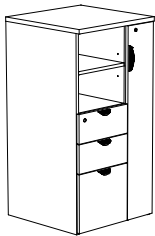

388-4724OUFWR-24

**MID-HEIGHT OPEN WARDROBE STORAGE**

INCLUDES COAT ROD. LOCKING DRAWERS & WARDROBE. 1 FIXED SHELF & 1 ADJUSTABLE SHELF IN CABINET.

OPEN SHELF/BOX/BOX/FILE/WARDROBE LEFT

**388-4724OUFWL-24**    **\$1,562**    **\$1,656**    \$544    **189**    **16.9**    **23.75**    **23.75**    **46.75**    **46.75**

OPEN SHELF/BOX/BOX/FILE/WARDROBE RIGHT

**388-4724OUFWR-24**    **\$1,562**    **\$1,656**    \$544    **189**    **16.9**    **23.75**    **23.75**    **46.75**    **46.75**

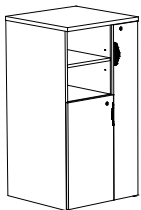

388-4724OCWR-24

**MID-HEIGHT OPEN WARDROBE STORAGE**

INCLUDES COAT ROD. LOCKING CABINET & WARDROBE. 1 FIXED SHELF & 1 ADJUSTABLE SHELF IN UPPER CUBBY. 1 FIXED SHELF & 1 ADJUSTABLE SHELF IN LOWER CABINET.

OPEN SHELF/CABINET/WARDROBE LEFT

**388-4724OCWL-24**    **\$1,451**    **\$1,538**    \$622    **166**    **16.9**    **23.75**    **23.75**    **46.75**    **46.75**

OPEN SHELF/CABINET/WARDROBE RIGHT

**388-4724OCWR-24**    **\$1,451**    **\$1,538**    \$622    **166**    **16.9**    **23.75**    **23.75**    **46.75**    **46.75**

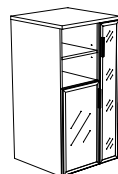
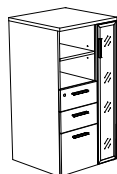
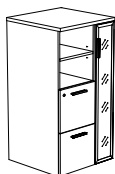
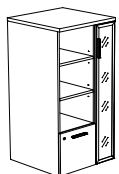

388-4724OFWR-24-AGD-FR    388-4724OFFWR-24-AGD-FR    388-4724OUFWR-24-AGD-FR    388-4724OCWR-24-AGD-FR

**\*OPTIONAL ALUMINUM GLAZED DOORS\***

- SELECT CLEAR (CL), FROSTED (FR) OR BRONZE (BR) PLEXIGLASS
- AGD DOORS INCLUDE SILVER FINISH BAR HANDLES. REFER TO **100-3** FOR OTHER HANDLE OPTIONS
- THE PRICE SHOWN FOR AGD DOORS IS AN UP-CHARGE THAT MUST BE ADDED TO THE BASE PRICE OF THE UNIT IT GOES ON.

# 388/600 TALL STORAGE CABINETS

| MODEL | 388  |      | 600       |      | AGD | WEIGHT | CUBE | W | D | 388             |    | 600 |    |
|-------|------|------|-----------|------|-----|--------|------|---|---|-----------------|----|-----|----|
|       | LIST | LIST | LIST      | LIST |     |        |      |   |   | H               | H  |     |    |
|       | 1"   | 1½"  | UP CHARGE | LBS  |     |        |      |   |   | FT <sup>3</sup> | IN | IN  | 1" |

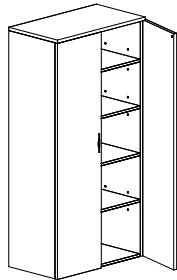

388-7236C-20

### TALL CABINET

2 FIXED SHELVES & 2 ADJUSTABLE SHELVES. LOCKING CABINET.

|              |         |         |         |     |    |      |       |      |      |
|--------------|---------|---------|---------|-----|----|------|-------|------|------|
| 388-6536C-20 | \$1,898 | \$2,012 | \$1,130 | 278 | 32 | 35.5 | 19.75 | 64.5 | 64.5 |
| 388-6536C-24 | \$2,101 | \$2,227 | \$1,130 | 290 | 39 | 35.5 | 23.75 | 64.5 | 64.5 |

2 FIXED SHELVES & 3 ADJUSTABLE SHELVES.

|              |         |         |         |     |    |      |       |      |      |
|--------------|---------|---------|---------|-----|----|------|-------|------|------|
| 388-7236C-20 | \$2,094 | \$2,220 | \$1,215 | 300 | 36 | 35.5 | 19.75 | 71.5 | 71.5 |
| 388-7236C-24 | \$2,254 | \$2,389 | \$1,215 | 316 | 43 | 35.5 | 23.75 | 71.5 | 71.5 |

3 FIXED SHELVES & 2 ADJUSTABLE SHELVES.

|              |         |         |         |     |    |      |       |       |       |
|--------------|---------|---------|---------|-----|----|------|-------|-------|-------|
| 388-7736C-20 | \$2,211 | \$2,344 | \$1,249 | 310 | 33 | 35.5 | 19.75 | 76.25 | 76.25 |
| 388-7736C-24 | \$2,349 | \$2,490 | \$1,249 | 323 | 39 | 35.5 | 35.5  | 76.25 | 76.25 |

3 FIXED SHELVES & 3 ADJUSTABLE SHELVES.

|              |         |         |         |     |    |      |       |       |       |
|--------------|---------|---------|---------|-----|----|------|-------|-------|-------|
| 388-8436C-20 | \$2,349 | \$2,490 | \$1,262 | 310 | 42 | 35.5 | 19.75 | 83.25 | 83.25 |
| 388-8436C-24 | \$2,494 | \$2,644 | \$1,262 | 334 | 50 | 35.5 | 23.75 | 83.25 | 83.25 |

- 30" WIDE UNIT AVAILABLE. CHANGE SKU FROM 36" TO 30". SAME PRICING.
- TO ADD BOOTSHELF, ADD **-BS** TO SKU. UP-CHARGES APPLY SEE [388/600-5](#)

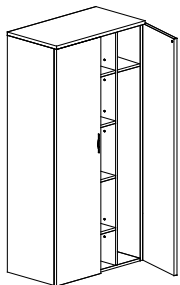

388-7236WC-20

### WARDROBE CABINET

2 FIXED SHELVES & 2 ADJUSTABLE SHELVES. FULL HEIGHT WARDROBE W/ HAT SHELF, LOCKING CABINET AND COAT ROD FOR 24" DEEP OR THREE COAT HOOKS ON THE 20" DEEP UNITS.

|               |         |         |         |     |    |      |       |      |      |
|---------------|---------|---------|---------|-----|----|------|-------|------|------|
| 388-6536WC-20 | \$2,130 | \$2,258 | \$1,130 | 270 | 32 | 35.5 | 19.75 | 64.5 | 64.5 |
| 388-6536WC-24 | \$2,183 | \$2,314 | \$1,130 | 280 | 39 | 35.5 | 23.75 | 64.5 | 64.5 |

2 FIXED SHELVES & 3 ADJUSTABLE SHELVES.

|               |         |         |         |     |    |      |       |      |      |
|---------------|---------|---------|---------|-----|----|------|-------|------|------|
| 388-7236WC-20 | \$2,292 | \$2,430 | \$1,215 | 290 | 36 | 35.5 | 19.75 | 71.5 | 71.5 |
| 388-7236WC-24 | \$2,359 | \$2,501 | \$1,215 | 300 | 43 | 35.5 | 23.75 | 71.5 | 71.5 |

3 FIXED SHELVES & 2 ADJUSTABLE SHELVES.

|               |         |         |         |     |    |      |       |       |       |
|---------------|---------|---------|---------|-----|----|------|-------|-------|-------|
| 388-7736WC-20 | \$2,359 | \$2,501 | \$1,249 | 305 | 37 | 35.5 | 19.75 | 76.25 | 76.25 |
| 388-7736WC-24 | \$2,410 | \$2,555 | \$1,249 | 317 | 41 | 35.5 | 23.75 | 76.25 | 76.25 |

3 FIXED SHELVES & 3 ADJUSTABLE SHELVES.

|               |         |         |         |     |    |      |       |       |       |
|---------------|---------|---------|---------|-----|----|------|-------|-------|-------|
| 388-8436WC-20 | \$2,496 | \$2,646 | \$1,262 | 312 | 42 | 35.5 | 19.75 | 83.25 | 83.25 |
| 388-8436WC-24 | \$2,548 | \$2,701 | \$1,262 | 330 | 50 | 35.5 | 23.75 | 83.25 | 83.25 |

- 30" WIDE UNIT AVAILABLE. CHANGE SKU FROM 36" TO 30". SAME PRICING.
- TO ADD BOOTSHELF, ADD **-BS** TO SKU. UP-CHARGES APPLY SEE [388/600-5](#)

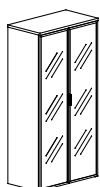

388-7736C-20-AGD-FR  
388-7236WC-20-AGD-FR

### \*OPTIONAL ALUMINUM GLAZED DOORS\*

- SELECT CLEAR (CL), FROSTED (FR) OR BRONZE (BR) PLEXI GLASS
- AGD DOORS INCLUDE SILVER FINISH BAR HANDLES. REFER TO [100-3](#) FOR OTHER HANDLE OPTIONS
- THE PRICE SHOWN FOR AGD DOORS IS AN UP-CHARGE THAT MUST BE ADDED TO THE BASE PRICE OF THE UNIT IT GOES ON.

| MODEL | 388  |      | 600       |  | AGD | WEIGHT<br>LBS | CUBE<br>FT <sup>3</sup> | W<br>IN | D<br>IN | 388 |     | 600 |  |
|-------|------|------|-----------|--|-----|---------------|-------------------------|---------|---------|-----|-----|-----|--|
|       | LIST | LIST | UP CHARGE |  |     |               |                         |         |         | H   | H   |     |  |
|       | 1"   | 1½"  |           |  |     |               |                         |         |         | 1"  | 1½" |     |  |

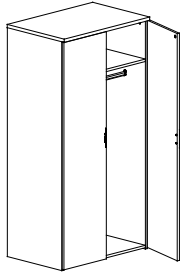

388-7236CLC

**DOUBLE DOOR CLOSET CABINET**

INCLUDES HAT SHELF & COAT ROD, OPTIONAL BOOT SHELF AVAILABLE W/ LOCKING CABINET.

|                |                |                |                |     |    |      |       |       |       |
|----------------|----------------|----------------|----------------|-----|----|------|-------|-------|-------|
| 388-6536CLC-24 | <b>\$1,909</b> | <b>\$2,024</b> | <i>\$1,130</i> | 270 | 32 | 35.5 | 23.75 | 64.5  | 64.5  |
| 388-7236CLC-24 | <b>\$2,106</b> | <b>\$2,232</b> | <i>\$1,215</i> | 325 | 36 | 35.5 | 23.75 | 71.5  | 71.5  |
| 388-7736CLC-24 | <b>\$2,223</b> | <b>\$2,356</b> | <i>\$1,249</i> | 330 | 37 | 35.5 | 23.75 | 76.25 | 76.25 |
| 388-8436CLC-24 | <b>\$2,361</b> | <b>\$2,503</b> | <i>\$1,262</i> | 339 | 42 | 35.5 | 23.75 | 83.25 | 83.25 |

**NOTE:**

- 20" DEPTH AVAILABLE. REPLACE -24 W/ -20 WHEN ORDERING AND USE THE SAME PRICING. COAT ROD REPLACED W/ COAT HOOKS IN 20" UNITS.
- TO ADD BOOT SHELF, ADD **-BS** TO SKU. UP-CHARGES APPLY SEE [388/600-5](#)

**SINGLE DOOR CLOSET CABINET**

INCLUDES HAT SHELF & COAT ROD, OPTIONAL BOOT SHELF AVAILABLE W/ LOCKING CABINET.

HINGED LEFT

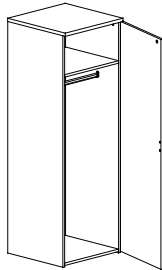

388-7224CLC-R-24

|                  |                |                |              |     |    |       |       |       |       |
|------------------|----------------|----------------|--------------|-----|----|-------|-------|-------|-------|
| 388-6524CLC-L-24 | <b>\$1,862</b> | <b>\$1,974</b> | <i>\$631</i> | 200 | 26 | 23.75 | 23.75 | 64.5  | 64.5  |
| 388-7224CLC-L-24 | <b>\$1,991</b> | <b>\$2,110</b> | <i>\$671</i> | 215 | 27 | 23.75 | 23.75 | 71.5  | 71.5  |
| 388-7724CLC-L-24 | <b>\$2,056</b> | <b>\$2,179</b> | <i>\$729</i> | 224 | 28 | 23.75 | 23.75 | 76.25 | 76.25 |
| 388-8424CLC-L-24 | <b>\$2,194</b> | <b>\$2,326</b> | <i>\$829</i> | 238 | 32 | 23.75 | 23.75 | 83.25 | 83.25 |

HINGED RIGHT (SHOWN)

|                  |                |                |              |     |    |       |       |       |       |
|------------------|----------------|----------------|--------------|-----|----|-------|-------|-------|-------|
| 388-6524CLC-R-24 | <b>\$1,862</b> | <b>\$1,974</b> | <i>\$631</i> | 200 | 26 | 23.75 | 23.75 | 64.5  | 64.5  |
| 388-7224CLC-R-24 | <b>\$1,991</b> | <b>\$2,110</b> | <i>\$671</i> | 215 | 27 | 23.75 | 23.75 | 71.5  | 71.5  |
| 388-7724CLC-R-24 | <b>\$2,056</b> | <b>\$2,179</b> | <i>\$729</i> | 224 | 28 | 23.75 | 23.75 | 76.25 | 76.25 |
| 388-8424CLC-L-24 | <b>\$2,194</b> | <b>\$2,326</b> | <i>\$829</i> | 238 | 32 | 23.75 | 23.75 | 83.25 | 83.25 |

- 20" DEPTH AVAILABLE. REPLACE -24 W/ -20 WHEN ORDERING AND USE THE SAME PRICING. COAT ROD REPLACED W/ COAT HOOKS IN 20" UNITS.
- TO ADD BOOT SHELF, ADD **-BS** TO SKU. UP-CHARGES APPLY SEE [388/600-5](#)

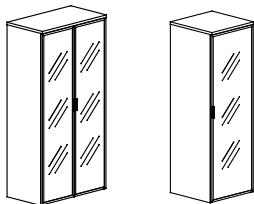

388-7236CLC-24-**AGD-FR**

388-7224CLC-R-24 - **AGD-FR**

**\*OPTIONAL ALUMINUM GLAZED DOORS\***

- SELECT CLEAR (CL), FROSTED (FR) OR BRONZE (BR) PLEXI GLASS
- AGD DOORS INCLUDE SILVER FINISH BAR HANDLES. REFER TO [100-3](#) FOR OTHER HANDLE OPTIONS
- THE PRICE SHOWN FOR AGD DOORS IS AN UP-CHARGE THAT MUST BE ADDED TO THE BASE PRICE OF THE UNIT IT GOES ON.

# 388/600 TALL STORAGE CABINETS

| MODEL | 388  |      | 600       |      | AGD | WEIGHT | CUBE | W | D | 388             |    | 600 |    |
|-------|------|------|-----------|------|-----|--------|------|---|---|-----------------|----|-----|----|
|       | LIST | LIST | LIST      | LIST |     |        |      |   |   | H               | H  |     |    |
|       | 1"   | 1½"  | UP CHARGE | LBS  |     |        |      |   |   | FT <sup>3</sup> | IN | IN  | 1" |

## STORAGE CABINET / LATERAL FILE

1 FIXED SHELF & 1 ADJUSTABLE SHELF. LOCKING CABINET & LATERAL FILES

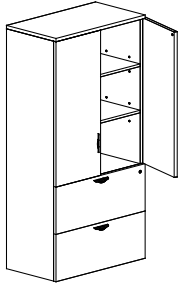

388-7236CLF-20

|                |         |         |       |     |    |      |       |      |      |
|----------------|---------|---------|-------|-----|----|------|-------|------|------|
| 388-6536CLF-20 | \$2,113 | \$2,240 | \$769 | 250 | 32 | 35.5 | 19.75 | 64.5 | 64.5 |
| 388-6536CLF-24 | \$2,312 | \$2,451 | \$769 | 264 | 39 | 35.5 | 23.75 | 64.5 | 64.5 |

1 FIXED SHELF & 2 ADJUSTABLE SHELVES. LOCKING CABINET & LATERAL FILES

|                |         |         |       |     |    |      |       |      |      |
|----------------|---------|---------|-------|-----|----|------|-------|------|------|
| 388-7236CLF-20 | \$2,339 | \$2,479 | \$854 | 302 | 36 | 35.5 | 19.75 | 71.5 | 71.5 |
| 388-7236CLF-24 | \$2,618 | \$2,775 | \$854 | 314 | 43 | 35.5 | 23.75 | 71.5 | 71.5 |

2 FIXED SHELVES & 1 ADJUSTABLE SHELF. LOCKING CABINET & LATERAL FILES

|                |         |         |       |     |    |      |       |       |       |
|----------------|---------|---------|-------|-----|----|------|-------|-------|-------|
| 388-7736CLF-20 | \$2,428 | \$2,574 | \$914 | 312 | 37 | 35.5 | 19.75 | 76.25 | 76.25 |
| 388-7736CLF-24 | \$2,708 | \$2,870 | \$914 | 320 | 39 | 35.5 | 23.75 | 76.25 | 76.25 |

2 FIXED SHELVES & 2 ADJUSTABLE SHELVES. LOCKING CABINET & LATERAL FILES

|                |         |         |         |     |    |      |       |       |       |
|----------------|---------|---------|---------|-----|----|------|-------|-------|-------|
| 388-8436CLF-20 | \$2,566 | \$2,720 | \$1,011 | 326 | 42 | 35.5 | 19.75 | 83.25 | 83.25 |
| 388-8436CLF-24 | \$2,846 | \$3,017 | \$1,011 | 337 | 50 | 35.5 | 23.75 | 83.25 | 83.25 |

## STORAGE CABINET / LATERAL COMBO

1 FIXED SHELF & 1 ADJUSTABLE SHELF. LOCKING CABINET, FILE & LATERAL FILE DRAWERS.

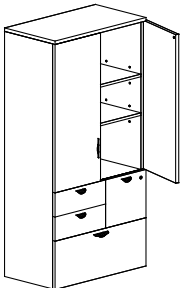

388-7236UFL-20

|                |         |         |       |     |    |      |       |      |      |
|----------------|---------|---------|-------|-----|----|------|-------|------|------|
| 388-6536UFL-20 | \$2,216 | \$2,349 | \$769 | 250 | 32 | 35.5 | 19.75 | 64.5 | 64.5 |
| 388-6536UFL-24 | \$2,421 | \$2,566 | \$769 | 264 | 39 | 35.5 | 23.75 | 64.5 | 64.5 |

1 FIXED SHELF & 2 ADJUSTABLE SHELVES. LOCKING CABINET, FILE & LATERAL FILE DRAWERS.

|                |         |         |       |     |    |      |       |      |      |
|----------------|---------|---------|-------|-----|----|------|-------|------|------|
| 388-7236UFL-20 | \$2,453 | \$2,600 | \$854 | 302 | 36 | 35.5 | 19.75 | 71.5 | 71.5 |
| 388-7236UFL-24 | \$2,725 | \$2,889 | \$854 | 314 | 43 | 35.5 | 23.75 | 71.5 | 71.5 |

2 FIXED SHELVES & 1 ADJUSTABLE SHELF. LOCKING CABINET, FILE & LATERAL FILE DRAWERS.

|                |         |         |       |     |    |      |       |       |       |
|----------------|---------|---------|-------|-----|----|------|-------|-------|-------|
| 388-7736UFL-20 | \$2,559 | \$2,713 | \$914 | 312 | 37 | 35.5 | 19.75 | 76.25 | 76.25 |
| 388-7736UFL-24 | \$2,771 | \$2,937 | \$914 | 328 | 39 | 35.5 | 23.75 | 76.25 | 76.25 |

2 FIXED SHELVES & 2 ADJUSTABLE SHELVES. LOCKING CABINET, FILE & LATERAL FILE DRAWERS.

|                |         |         |         |     |    |      |       |       |       |
|----------------|---------|---------|---------|-----|----|------|-------|-------|-------|
| 388-8436UFL-20 | \$2,697 | \$2,859 | \$1,011 | 326 | 42 | 35.5 | 19.75 | 83.25 | 83.25 |
| 388-8436UFL-24 | \$2,908 | \$3,082 | \$1,011 | 337 | 50 | 35.5 | 23.75 | 83.25 | 83.25 |

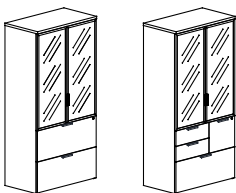

388-6536CLF-20-AGD-FR

388-6536UFL-20-AGD-FR

### \*OPTIONAL ALUMINUM GLAZED DOORS\*

- SELECT CLEAR (CL), FROSTED (FR) OR BRONZE (BR) PLEXIGLASS
- AGD DOORS INCLUDE SILVER FINISH BAR HANDLES. REFER TO [100-3](#) FOR OTHER HANDLE OPTIONS
- THE PRICE SHOWN FOR AGD DOORS IS AN UP-CHARGE THAT MUST BE ADDED TO THE BASE PRICE OF THE UNIT IT GOES ON.

| MODEL | 388  |      | 600       |      | AGD | WEIGHT | CUBE | W | D | 388 |    | 600 |    |
|-------|------|------|-----------|------|-----|--------|------|---|---|-----|----|-----|----|
|       | LIST | LIST | LIST      | LIST |     |        |      |   |   | H   | H  |     |    |
|       | 1"   | 1½"  | UP CHARGE | LBS  |     |        |      |   |   | FT³ | IN | IN  | 1" |

**STORAGE CABINETS**



388-6516COF-L-24

SINGLE DOOR/OPEN SHELF/FILE DRAWER CABINET - HINGED LEFT  
LOCKING CABINET & DRAWER. 1 FIXED SHELF & 1 ADJUSTABLE SHELF IN CABINET.

**388-6516COF-L-24**    **\$1,409**    **\$1,494**    \$640    **164**    **18.8**    **15.75**    **23.75**    **64.5**    **64.5**

1 FIXED SHELF & 2 ADJUSTABLE SHELVES IN CABINET.

**388-7216COF-L-24**    **\$1,557**    **\$1,650**    \$711    **181**    **20.8**    **15.75**    **23.75**    **71.5**    **71.5**

2 FIXED SHELVES & 1 ADJUSTABLE SHELF IN CABINET.

**388-7716COF-L-24**    **\$1,638**    **\$1,736**    \$785    **192**    **22**    **15.75**    **23.75**    **76.25**    **76.25**

2 FIXED SHELVES & 2 ADJUSTABLE SHELVES IN CABINET.

**388-8416COF-L-24**    **\$1,776**    **\$1,883**    \$885    **199**    **24**    **15.75**    **23.75**    **83.25**    **83.25**

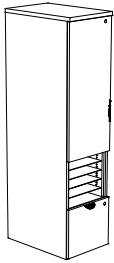

SHOWN WITH OPTIONAL VERTICAL  
CUBBY INSERT  
388-1413VCI

SINGLE DOOR/OPEN SHELF/FILE DRAWER CABINET - HINGED RIGHT  
LOCKING CABINET & DRAWER. 1 FIXED SHELF & 1 ADJUSTABLE SHELF IN CABINET.

**388-6516COF-R-24**    **\$1,409**    **\$1,494**    \$640    **164**    **18.8**    **15.75**    **23.75**    **64.5**    **64.5**

1 FIXED SHELF & 2 ADJUSTABLE SHELVES IN CABINET.

**388-7216COF-R-24**    **\$1,557**    **\$1,650**    \$711    **181**    **20.8**    **15.75**    **23.75**    **71.5**    **71.5**

2 FIXED SHELVES & 1 ADJUSTABLE SHELF IN CABINET.

**388-7716COF-R-24**    **\$1,638**    **\$1,736**    \$785    **192**    **22**    **15.75**    **23.75**    **76.25**    **76.25**

2 FIXED SHELVES & 2 ADJUSTABLE SHELVES IN CABINET.

**388-8416COF-R-24**    **\$1,776**    **\$1,883**    \$885    **199**    **24**    **15.75**    **23.75**    **83.25**    **83.25**

• 20" DEPTH AVAILABLE. REPLACE -24 W/ -20 WHEN ORDERING & USE -24 PRICE.

**STORAGE CABINETS**

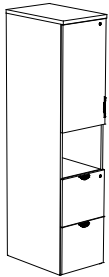

388-6516COFF-L-24

SINGLE DOOR/OPEN SHELF/FILE/FILE DRAWER CABINET - HINGED LEFT  
LOCKING CABINET & DRAWERS. 1 FIXED SHELF & 1 ADJUSTABLE SHELF IN CABINET.

**388-6516COFF-L-24**    **\$1,476**    **\$1,565**    \$640    **171**    **18.8**    **15.75**    **23.75**    **64.5**    **64.5**

1 FIXED SHELF & 2 ADJUSTABLE SHELVES IN CABINET.

**388-7216COFF-L-24**    **\$1,611**    **\$1,708**    \$711    **183**    **20.8**    **15.75**    **23.75**    **71.5**    **71.5**

2 FIXED SHELVES IN CABINET.

**388-7716COFF-L-24**    **\$1,714**    **\$1,817**    \$785    **198**    **22**    **15.75**    **23.75**    **76.25**    **76.25**

2 FIXED SHELVES & 1 ADJUSTABLE SHELF IN CABINET.

**388-8416COFF-L-24**    **\$1,852**    **\$1,963**    \$885    **210**    **24**    **15.75**    **23.75**    **83.25**    **83.25**

SINGLE DOOR/OPEN SHELF/FILE/FILE DRAWER CABINET - HINGED RIGHT  
LOCKING CABINET & DRAWERS. 1 FIXED SHELF & 1 ADJUSTABLE SHELF IN CABINET.

**388-6516COFF-R-24**    **\$1,476**    **\$1,565**    \$640    **171**    **18.8**    **15.75**    **23.75**    **64.5**    **64.5**

1 FIXED SHELF & 2 ADJUSTABLE SHELVES IN CABINET.

**388-7216COFF-R-24**    **\$1,611**    **\$1,708**    \$711    **183**    **20.8**    **15.75**    **23.75**    **71.5**    **71.5**

2 FIXED SHELVES IN CABINET.

**388-7716COFF-R-24**    **\$1,714**    **\$1,817**    \$785    **198**    **22**    **15.75**    **23.75**    **76.25**    **76.25**

2 FIXED SHELVES & 1 ADJUSTABLE SHELF IN CABINET.

**388-8416COFF-R-24**    **\$1,852**    **\$1,963**    \$885    **210**    **24**    **15.75**    **23.75**    **83.25**    **83.25**

• 20" DEPTH AVAILABLE. REPLACE -24 W/ -20 WHEN ORDERING & USE -24 PRICE.

# 388/600 TALL STORAGE CABINETS

| MODEL | 388  |      | 600       |      | AGD | WEIGHT | CUBE | W | D | 388             |    | 600 |    |
|-------|------|------|-----------|------|-----|--------|------|---|---|-----------------|----|-----|----|
|       | LIST | LIST | LIST      | LIST |     |        |      |   |   | H               | H  |     |    |
|       | 1"   | 1½"  | UP CHARGE | LBS  |     |        |      |   |   | FT <sup>3</sup> | IN | IN  | 1" |

## STORAGE CABINETS

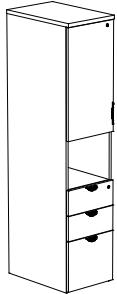

388-6516COUF-L-24

SINGLE DOOR/OPEN SHELF/BOX/BOX/FILE DRAWER CABINET - HINGED LEFT LOCKING CABINET & DRAWERS. 1 FIXED SHELF & 1 ADJUSTABLE SHELF IN CABINET.

|  |         |         |       |     |      |       |       |       |       |
|--|---------|---------|-------|-----|------|-------|-------|-------|-------|
| 388-6516COUF-L-24                                | \$1,512 | \$1,603 | \$640 | 178 | 18.8 | 15.75 | 23.75 | 64.5  | 64.5  |
| 388-7216COUF-L-24                                | \$1,715 | \$1,818 | \$711 | 190 | 20.8 | 15.75 | 23.75 | 71.5  | 71.5  |
| 2 FIXED SHELVES & 1 ADJUSTABLE SHELF IN CABINET. |         |         |       |     |      |       |       |       |       |
| 388-7716COUF-L-24                                | \$1,823 | \$1,932 | \$785 | 198 | 22   | 15.75 | 23.75 | 76.25 | 76.25 |
| 388-8416COUF-L-24                                | \$1,961 | \$2,079 | \$885 | 210 | 24   | 15.75 | 23.75 | 83.25 | 83.25 |

SINGLE DOOR/OPEN SHELF/BOX/BOX/FILE DRAWER CABINET - HINGED RIGHT LOCKING CABINET & DRAWERS. 1 FIXED SHELF & 1 ADJUSTABLE SHELF IN CABINET.

|  |         |         |       |     |      |       |       |       |       |
|--|---------|---------|-------|-----|------|-------|-------|-------|-------|
| 388-6516COUF-R-24                                | \$1,512 | \$1,603 | \$640 | 178 | 18.8 | 15.75 | 23.75 | 64.5  | 64.5  |
| 388-7216COUF-R-24                                | \$1,715 | \$1,818 | \$711 | 190 | 20.8 | 15.75 | 23.75 | 71.5  | 71.5  |
| 2 FIXED SHELVES & 1 ADJUSTABLE SHELF IN CABINET. |         |         |       |     |      |       |       |       |       |
| 388-7716COUF-R-24                                | \$1,823 | \$1,932 | \$785 | 198 | 22   | 15.75 | 23.75 | 76.25 | 76.25 |
| 388-8416COUF-R-24                                | \$1,961 | \$2,079 | \$885 | 210 | 24   | 15.75 | 23.75 | 83.25 | 83.25 |

- 20" DEPTH AVAILABLE. REPLACE -24 W/ -20 WHEN ORDERING & USE -24 PRICE.

## STORAGE CABINETS

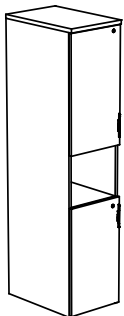

388-6516COC-L-24

SINGLE DOOR CABINET/OPEN SHELF/SINGLE DOOR CABINET - HINGED LEFT LOCKING CABINETS. 1 FIXED SHELF & 1 ADJUSTABLE SHELF IN EACH CABINET.

|   |         |         |       |     |      |       |       |       |       |
|---|---------|---------|-------|-----|------|-------|-------|-------|-------|
| 388-6516COC-L-24  | \$1,347 | \$1,428 | \$640 | 160 | 18.8 | 15.75 | 23.75 | 64.5  | 64.5  |
| 388-6524COC-L-24  | \$1,477 | \$1,566 | \$694 | 180 | 26   | 23.75 | 23.75 | 64.5  | 64.5  |
| 388-7216COC-L-24  | \$1,549 | \$1,642 | \$711 | 174 | 24   | 15.75 | 23.75 | 71.5  | 71.5  |
| 388-7224COC-L-24  | \$1,621 | \$1,718 | \$735 | 191 | 29.3 | 23.75 | 23.75 | 71.5  | 71.5  |
| 2 FIXED SHELVES & 1 ADJUSTABLE SHELF IN UPPER CABINET, 1 FIXED SHELF & 1 ADJUSTABLE SHELF IN LOWER CABINET. |         |         |       |     |      |       |       |       |       |
| 388-7716COC-L-24  | \$1,588 | \$1,683 | \$785 | 192 | 22   | 15.75 | 23.75 | 76.25 | 76.25 |
| 388-7724COC-L-24  | \$1,719 | \$1,822 | \$795 | 202 | 30   | 23.75 | 23.75 | 76.25 | 76.25 |
| 388-8416COC-L-24  | \$1,726 | \$1,830 | \$885 | 199 | 24   | 15.75 | 23.75 | 83.25 | 83.25 |
| 388-8424COC-L-24  | \$1,857 | \$1,968 | \$893 | 215 | 35   | 23.75 | 23.75 | 83.25 | 83.25 |

- 20" DEPTH AVAILABLE. REPLACE -24 W/ -20 WHEN ORDERING & USE -24 PRICE.
- OPTIONAL VERTICAL CUBBY INSERTS - 388-1413VCI ARE DESIGNED TO FIT IN 16" SIZED UNITS.

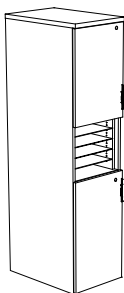

388-6516COC-L-24  
SHOWN WITH OPTIONAL  
VERTICAL CUBBY INSERT  
388-1413VCI



| MODEL | 388  |      | 600       |        |                 |    |    | 388 |     | 600 |
|-------|------|------|-----------|--------|-----------------|----|----|-----|-----|-----|
|       | LIST | LIST | AGD       | WEIGHT | CUBE            | W  | D  | H   | H   |     |
|       | 1"   | 1½"  | UP CHARGE | LBS    | FT <sup>3</sup> | IN | IN | 1"  | 1½" |     |

**STORAGE CABINETS**

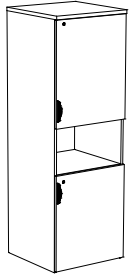

388-6524COC-R-24

SINGLE DOOR CABINET/OPEN SHELF/SINGLE DOOR CABINET - HINGED RIGHT LOCKING CABINETS. 1 FIXED SHELF & 1 ADJUSTABLE SHELF IN EACH CABINET.

|   |         |         |       |     |      |       |       |       |       |
|---|---------|---------|-------|-----|------|-------|-------|-------|-------|
| 388-6516COC-R-24  | \$1,347 | \$1,428 | \$640 | 160 | 18.8 | 15.75 | 23.75 | 64.5  | 64.5  |
| 388-6524COC-R-24  | \$1,477 | \$1,566 | \$694 | 180 | 26   | 23.75 | 23.75 | 64.5  | 64.5  |
| 388-7216COC-R-24  | \$1,549 | \$1,642 | \$711 | 174 | 24   | 15.75 | 23.75 | 71.5  | 71.5  |
| 388-7224COC-R-24  | \$1,621 | \$1,718 | \$735 | 191 | 29.3 | 23.75 | 23.75 | 71.5  | 71.5  |
| 2 FIXED SHELVES & 1 ADJUSTABLE SHELF IN UPPER CABINET, 1 FIXED SHELF & 1 ADJUSTABLE SHELF IN LOWER CABINET. |         |         |       |     |      |       |       |       |       |
| 388-7716COC-R-24  | \$1,588 | \$1,683 | \$785 | 192 | 22   | 15.75 | 23.75 | 76.25 | 76.25 |
| 388-7724COC-R-24  | \$1,719 | \$1,822 | \$795 | 202 | 30   | 23.75 | 23.75 | 76.25 | 76.25 |
| 388-8416COC-R-24  | \$1,726 | \$1,830 | \$885 | 199 | 24   | 15.75 | 23.75 | 83.25 | 83.25 |
| 388-8424COC-R-24  | \$1,857 | \$1,968 | \$893 | 215 | 35   | 23.75 | 23.75 | 83.25 | 83.25 |

- 20" DEPTH AVAILABLE. REPLACE -24 W/ -20 WHEN ORDERING & USE -24 PRICE.
- OPTIONAL VERTICAL CUBBY INSERTS - 388-1413VCI ARE DESIGNED TO FIT IN 16" WIDE SIZED UNITS.

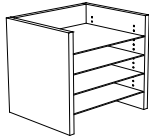

**VERTICAL CUBBY INSERT**

OPTIONAL CUBBY INSERT, FITS 20" & 24" DEEP CABINETS

|             |       |       |     |    |      |       |    |       |     |
|-------------|-------|-------|-----|----|------|-------|----|-------|-----|
| 388-1413VCI | \$257 | \$257 | N/A | 15 | .344 | 14.25 | 12 | 12.75 | N/A |
|-------------|-------|-------|-----|----|------|-------|----|-------|-----|

**AVAILABLE FINISH:** BLACK (BL)

**\*OPTIONAL ALUMINUM GLAZED DOORS\***

- SELECT CLEAR (CL), FROSTED (FR) OR BRONZE (BR) PLEXIGLASS
- AGD DOORS INCLUDE SILVER FINISH BAR HANDLES. REFER TO **100-3** FOR OTHER HANDLE OPTIONS
- THE PRICE SHOWN FOR AGD DOORS IS AN UP-CHARGE THAT MUST BE ADDED TO THE BASE PRICE OF THE UNIT IT GOES ON.

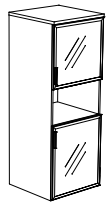
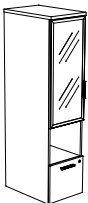

388-6516COF-L-24-AGD-FR 388-6516COFF-L-24-AGD-FR 388-6516COUF-L-24-AGD-FR 388-6516COC-L-24-AGD-FR 388-6524COC-R-24-AGD-FR

# 388/600 TALL WARDROBE CABINETS

| MODEL | 388  |      | 600       |  | AGD | WEIGHT<br>LBS | CUBE<br>FT <sup>3</sup> | W<br>IN | D<br>IN | 388 |     | 600 |  |
|-------|------|------|-----------|--|-----|---------------|-------------------------|---------|---------|-----|-----|-----|--|
|       | LIST | LIST | UP CHARGE |  |     |               |                         |         |         | H   | H   |     |  |
|       | 1"   | 1½"  |           |  |     |               |                         |         |         | 1"  | 1½" |     |  |

## WARDROBE STORAGE

CABINET/OPEN SHELF/FILE/WARDROBE LEFT. INCLUDES COAT ROD & HAT SHELF. LOCKING FILE DRAWER & WARDROBE. 1 FIXED SHELF & 1 ADJUSTABLE SHELF IN CABINET.

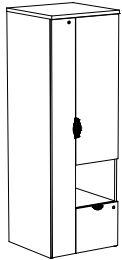

388-6524COFWL-24

|  |         |         |       |     |      |       |       |       |       |
|--|---------|---------|-------|-----|------|-------|-------|-------|-------|
| 388-6524COFWL-24                                   | \$1,929 | \$2,045 | \$694 | 196 | 26   | 23.75 | 23.75 | 64.5  | 64.5  |
| 388-6530COFWL-24                                   | \$2,035 | \$2,157 | \$711 | 212 | 32.8 | 29.5  | 23.75 | 64.5  | 64.5  |
| 1 FIXED SHELF & 2 ADJUSTABLE SHELVES IN CABINET.   |         |         |       |     |      |       |       |       |       |
| 388-7224COFWL-24                                   | \$1,943 | \$2,060 | \$735 | 170 | 29.3 | 23.75 | 23.75 | 71.5  | 71.5  |
| 388-7230COFWL-24                                   | \$2,035 | \$2,157 | \$762 | 220 | 36.3 | 29.5  | 23.75 | 71.5  | 71.5  |
| 2 FIXED SHELVES & 2 ADJUSTABLE SHELVES IN CABINET. |         |         |       |     |      |       |       |       |       |
| 388-7724COFWL-24                                   | \$2,053 | \$2,176 | \$795 | 225 | 30   | 23.75 | 23.75 | 76.25 | 76.25 |
| 388-7730COFWL-24                                   | \$2,151 | \$2,280 | \$822 | 255 | 38   | 29.5  | 23.75 | 76.25 | 76.25 |
| 2 FIXED SHELVES & 3 ADJUSTABLE SHELVES IN CABINET. |         |         |       |     |      |       |       |       |       |
| 388-8424COFWL-24                                   | \$2,191 | \$2,322 | \$893 | 240 | 35   | 23.75 | 23.75 | 83.25 | 83.25 |
| 388-8430COFWL-24                                   | \$2,289 | \$2,426 | \$920 | 270 | 42   | 29.5  | 23.75 | 83.25 | 83.25 |

CABINET/OPEN SHELF/FILE/WARDROBE RIGHT. INCLUDES COAT ROD & HAT SHELF. LOCKING FILE DRAWER & WARDROBE. 1 FIXED SHELF & 1 ADJUSTABLE SHELF IN CABINET.

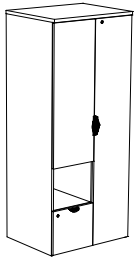

388-6530COFWR-24

|  |         |         |       |     |      |       |       |       |       |
|--|---------|---------|-------|-----|------|-------|-------|-------|-------|
| 388-6524COFWR-24                                   | \$1,929 | \$2,045 | \$694 | 196 | 26   | 23.75 | 23.75 | 64.5  | 64.5  |
| 388-6530COFWR-24                                   | \$2,035 | \$2,157 | \$711 | 212 | 32.8 | 29.5  | 23.75 | 64.5  | 64.5  |
| 1 FIXED SHELF & 2 ADJUSTABLE SHELVES IN CABINET.   |         |         |       |     |      |       |       |       |       |
| 388-7224COFWR-24                                   | \$1,943 | \$2,060 | \$735 | 170 | 29.3 | 23.75 | 23.75 | 71.5  | 71.5  |
| 388-7230COFWR-24                                   | \$2,035 | \$2,157 | \$762 | 220 | 36.3 | 29.5  | 23.75 | 71.5  | 71.5  |
| 2 FIXED SHELVES & 2 ADJUSTABLE SHELVES IN CABINET. |         |         |       |     |      |       |       |       |       |
| 388-7724COFWR-24                                   | \$2,053 | \$2,176 | \$795 | 225 | 30   | 23.75 | 23.75 | 76.25 | 76.25 |
| 388-7730COFWR-24                                   | \$2,151 | \$2,280 | \$822 | 255 | 38   | 29.5  | 23.75 | 76.25 | 76.25 |
| 2 FIXED SHELVES & 3 ADJUSTABLE SHELVES IN CABINET. |         |         |       |     |      |       |       |       |       |
| 388-8424COFWR-24                                   | \$2,191 | \$2,322 | \$893 | 240 | 35   | 23.75 | 23.75 | 83.25 | 83.25 |
| 388-8430COFWR-24                                   | \$2,289 | \$2,426 | \$920 | 270 | 42   | 29.5  | 23.75 | 83.25 | 83.25 |

388-6530COFWR-24 SHOWN WITH OPTIONAL VERTICAL CUBBY INSERT 388-1413VCI

## WARDROBE STORAGE

CABINET/OPEN SHELF/FILE/FILE/WARDROBE LEFT. INCLUDES COAT ROD & HAT SHELF. LOCKING DRAWERS & WARDROBE. 1 FIXED SHELF & 1 ADJUSTABLE SHELF IN CABINET.

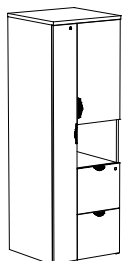

388-6524COFFWL-24

|  |         |         |       |     |      |       |       |       |       |
|--|---------|---------|-------|-----|------|-------|-------|-------|-------|
| 388-6524COFFWL-24                                  | \$1,945 | \$2,062 | \$694 | 206 | 26   | 23.75 | 23.75 | 64.5  | 64.5  |
| 388-6530COFFWL-24                                  | \$2,017 | \$2,138 | \$711 | 232 | 32.8 | 29.5  | 23.75 | 64.5  | 64.5  |
| 388-7224COFFWL-24                                  | \$2,082 | \$2,207 | \$735 | 230 | 29.3 | 23.75 | 23.75 | 71.5  | 71.5  |
| 388-7230COFFWL-24                                  | \$2,191 | \$2,322 | \$762 | 258 | 36.3 | 29.5  | 23.75 | 71.5  | 71.5  |
| 2 FIXED SHELVES & 1 ADJUSTABLE SHELF IN CABINET.   |         |         |       |     |      |       |       |       |       |
| 388-7724COFFWL-24                                  | \$2,163 | \$2,293 | \$795 | 235 | 30   | 23.75 | 23.75 | 76.25 | 76.25 |
| 388-7730COFFWL-24                                  | \$2,307 | \$2,445 | \$822 | 274 | 38   | 29.5  | 23.75 | 76.25 | 76.25 |
| 2 FIXED SHELVES & 2 ADJUSTABLE SHELVES IN CABINET. |         |         |       |     |      |       |       |       |       |
| 388-8424COFFWL-24                                  | \$2,300 | \$2,438 | \$893 | 261 | 35   | 23.75 | 23.75 | 83.25 | 83.25 |
| 388-8430COFFWL-24                                  | \$2,444 | \$2,591 | \$920 | 294 | 42   | 29.5  | 23.75 | 83.25 | 83.25 |

| MODEL | 388  |      | 600       |      | AGD | WEIGHT | CUBE | W | D | 388 |    | 600 |    |
|-------|------|------|-----------|------|-----|--------|------|---|---|-----|----|-----|----|
|       | LIST | LIST | LIST      | LIST |     |        |      |   |   | H   | H  |     |    |
|       | 1"   | 1½"  | UP CHARGE | LBS  |     |        |      |   |   | FT³ | IN | IN  | 1" |

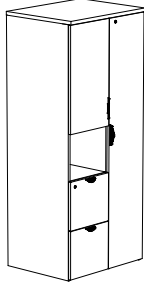

388-6530COFFWR-24

CABINET/OPEN SHELF/FILE/FILE/WARDROBE RIGHT. INCLUDES COAT ROD & HAT SHELF. LOCKING DRAWERS & WARDROBE. 1 FIXED SHELF & 1 ADJUSTABLE SHELF IN CABINET.

|                   |         |         |       |     |      |       |       |      |      |
|-------------------|---------|---------|-------|-----|------|-------|-------|------|------|
| 388-6524COFFWR-24 | \$1,945 | \$2,062 | \$694 | 206 | 26   | 23.75 | 23.75 | 64.5 | 64.5 |
| 388-6530COFFWR-24 | \$2,017 | \$2,138 | \$711 | 232 | 32.8 | 29.5  | 23.75 | 64.5 | 64.5 |
| 388-7224COFFWR-24 | \$2,082 | \$2,207 | \$735 | 230 | 29.3 | 23.75 | 23.75 | 71.5 | 71.5 |
| 388-7230COFFWR-24 | \$2,191 | \$2,322 | \$762 | 258 | 36.3 | 29.5  | 23.75 | 71.5 | 71.5 |

2 FIXED SHELVES & 1 ADJUSTABLE SHELF IN CABINET.

|                   |         |         |       |     |    |       |       |       |       |
|-------------------|---------|---------|-------|-----|----|-------|-------|-------|-------|
| 388-7724COFFWR-24 | \$2,163 | \$2,293 | \$795 | 235 | 30 | 23.75 | 23.75 | 76.25 | 76.25 |
| 388-7730COFFWR-24 | \$2,307 | \$2,445 | \$822 | 274 | 38 | 29.5  | 23.75 | 76.25 | 76.25 |

2 FIXED SHELVES & 2 ADJUSTABLE SHELVES IN CABINET.

|                   |         |         |       |     |    |       |       |       |       |
|-------------------|---------|---------|-------|-----|----|-------|-------|-------|-------|
| 388-8424COFFWR-24 | \$2,300 | \$2,438 | \$893 | 261 | 35 | 23.75 | 23.75 | 83.25 | 83.25 |
| 388-8430COFFWR-24 | \$2,444 | \$2,591 | \$920 | 294 | 42 | 29.5  | 23.75 | 83.25 | 83.25 |

- 20" DEPTH AVAILABLE. REPLACE -24 W/ -20 WHEN ORDERING & USE -24 PRICE. COAT ROD REPLACED W/ COAT HOOKS IN 20" UNITS.
- TO ADD BOOTSHelf, ADD -BS TO SKU. UP-CHARGES APPLY SEE [388/600-5](#)

**WARDROBE STORAGE**

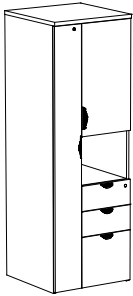

388-6524COUFWL-24

CABINET/OPEN SHELF/BOX/BOX/FILE/WARDROBE LEFT. INCLUDES COAT ROD & HAT SHELF. LOCKING DRAWERS & WARDROBE. 1 FIXED SHELF & 1 ADJUSTABLE SHELF IN CABINET.

|                   |         |         |       |     |      |       |       |      |      |
|-------------------|---------|---------|-------|-----|------|-------|-------|------|------|
| 388-6524COUFWL-24 | \$2,047 | \$2,170 | \$694 | 220 | 26   | 23.75 | 23.75 | 64.5 | 64.5 |
| 388-6530COUFWL-24 | \$2,139 | \$2,267 | \$711 | 234 | 32.8 | 29.5  | 23.75 | 64.5 | 64.5 |
| 388-7224COUFWL-24 | \$2,186 | \$2,317 | \$735 | 231 | 29.3 | 23.75 | 23.75 | 71.5 | 71.5 |
| 388-7230COUFWL-24 | \$2,342 | \$2,483 | \$762 | 291 | 36.3 | 29.5  | 23.75 | 71.5 | 71.5 |

2 FIXED SHELVES & 1 ADJUSTABLE SHELF IN CABINET.

|                   |         |         |       |     |    |       |       |       |       |
|-------------------|---------|---------|-------|-----|----|-------|-------|-------|-------|
| 388-7724COUFWL-24 | \$2,262 | \$2,398 | \$795 | 235 | 30 | 23.75 | 23.75 | 76.25 | 76.25 |
| 388-7730COUFWL-24 | \$2,389 | \$2,532 | \$822 | 274 | 38 | 29.5  | 23.75 | 76.25 | 76.25 |

2 FIXED SHELVES & 2 ADJUSTABLE SHELVES IN CABINET.

|                   |         |         |       |     |    |       |       |       |       |
|-------------------|---------|---------|-------|-----|----|-------|-------|-------|-------|
| 388-8424COUFWL-24 | \$2,400 | \$2,544 | \$893 | 261 | 35 | 23.75 | 23.75 | 83.25 | 83.25 |
| 388-8430COUFWL-24 | \$2,526 | \$2,678 | \$920 | 294 | 42 | 29.5  | 23.75 | 83.25 | 83.25 |

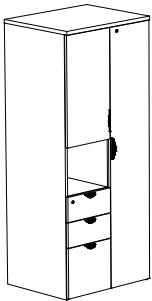

388-6530COUFWL-24

CABINET/OPEN SHELF/BOX/BOX/FILE/WARDROBE RIGHT. INCLUDES COAT ROD & HAT SHELF. LOCKING DRAWERS & WARDROBE. 1 FIXED SHELF & 1 ADJUSTABLE SHELF IN CABINET.

|                   |         |         |       |     |      |       |       |      |      |
|-------------------|---------|---------|-------|-----|------|-------|-------|------|------|
| 388-6524COUFWR-24 | \$2,047 | \$2,170 | \$694 | 220 | 26   | 23.75 | 23.75 | 64.5 | 64.5 |
| 388-6530COUFWR-24 | \$2,139 | \$2,267 | \$711 | 234 | 32.8 | 29.5  | 23.75 | 64.5 | 64.5 |
| 388-7224COUFWR-24 | \$2,186 | \$2,317 | \$735 | 231 | 29.3 | 23.75 | 23.75 | 71.5 | 71.5 |
| 388-7230COUFWR-24 | \$2,342 | \$2,483 | \$762 | 291 | 36.3 | 29.5  | 23.75 | 71.5 | 71.5 |

2 FIXED SHELVES & 1 ADJUSTABLE SHELF IN CABINET.

|                   |         |         |       |     |    |       |       |       |       |
|-------------------|---------|---------|-------|-----|----|-------|-------|-------|-------|
| 388-7724COUFWR-24 | \$2,262 | \$2,398 | \$795 | 235 | 30 | 23.75 | 23.75 | 76.25 | 76.25 |
| 388-7730COUFWR-24 | \$2,389 | \$2,532 | \$822 | 274 | 38 | 29.5  | 23.75 | 76.25 | 76.25 |

2 FIXED SHELVES & 2 ADJUSTABLE SHELVES IN CABINET.

|                   |         |         |       |     |    |       |       |       |       |
|-------------------|---------|---------|-------|-----|----|-------|-------|-------|-------|
| 388-8424COUFWR-24 | \$2,400 | \$2,544 | \$893 | 261 | 35 | 23.75 | 23.75 | 83.25 | 83.25 |
| 388-8430COUFWR-24 | \$2,526 | \$2,678 | \$920 | 294 | 42 | 29.5  | 23.75 | 83.25 | 83.25 |

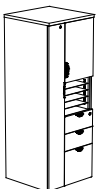

OPTIONAL VERTICAL CUBBY INSERT 388-1413VCI

- 20" DEPTH AVAILABLE. REPLACE -24 W/ -20 WHEN ORDERING & USE -24 PRICE. COAT ROD REPLACED W/ COAT HOOKS IN 20" UNITS.
- TO ADD BOOTSHelf, ADD -BS TO SKU. UP-CHARGES APPLY SEE [388/600-5](#)

# 388/600 TALL WARDROBE CABINETS

| MODEL | 388  |      | 600       |  | AGD | WEIGHT<br>LBS | CUBE<br>FT <sup>3</sup> | W<br>IN | D<br>IN | 388 |     | 600 |  |
|-------|------|------|-----------|--|-----|---------------|-------------------------|---------|---------|-----|-----|-----|--|
|       | LIST | LIST | UP CHARGE |  |     |               |                         |         |         | H   | H   |     |  |
|       | 1"   | 1½"  |           |  |     |               |                         |         |         | 1"  | 1½" |     |  |

## WARDROBE STORAGE

CABINET/OPEN SHELF/CABINET/WARDROBE LEFT

INCLUDES COAT ROD & HAT SHELF. LOWER CABINET & WARDROBE LOCK. 1 FIXED SHELF & 1 ADJUSTABLE SHELF IN EACH CABINET.

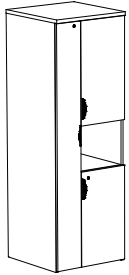

388-6524COCWL-24

|   |         |         |         |     |      |       |       |       |       |
|---|---------|---------|---------|-----|------|-------|-------|-------|-------|
| 388-6524COCWL-24  | \$1,813 | \$1,922 | \$1,052 | 196 | 26   | 23.75 | 23.75 | 64.5  | 64.5  |
| 388-6530COCWL-24  | \$1,907 | \$2,021 | \$1,076 | 266 | 32.8 | 29.5  | 23.75 | 64.5  | 64.5  |
| 388-7224COCWL-24  | \$2,091 | \$2,216 | \$1,117 | 248 | 29.3 | 23.75 | 23.75 | 71.5  | 71.5  |
| 388-7230COCWL-24  | \$2,186 | \$2,317 | \$1,124 | 249 | 36.3 | 29.5  | 23.75 | 71.5  | 71.5  |
| 1 FIXED SHELF & 2 ADJUSTABLE SHELVES IN UPPER CABINET, 1 FIXED SHELF & 1 ADJUSTABLE SHELF IN LOWER CABINET. |         |         |         |     |      |       |       |       |       |
| 388-7724COCWL-24  | \$2,172 | \$2,302 | \$1,177 | 225 | 30   | 23.75 | 23.75 | 76.25 | 76.25 |
| 388-7730COCWL-24  | \$2,294 | \$2,432 | \$1,183 | 255 | 38   | 29.5  | 23.75 | 76.25 | 76.25 |
| 388-8424COCWL-24  | \$2,310 | \$2,449 | \$1,249 | 240 | 35   | 23.75 | 23.75 | 83.25 | 83.25 |
| 388-8430COCWL-24  | \$2,431 | \$2,577 | \$1,249 | 270 | 42   | 29.5  | 23.75 | 83.25 | 83.25 |

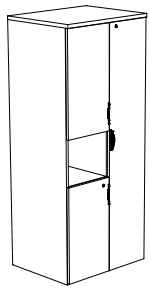

388-6530COCWR-24

CABINET/OPEN SHELF/CABINET/WARDROBE RIGHT

INCLUDES COAT ROD & HAT SHELF. LOWER CABINET & WARDROBE LOCK. 1 FIXED SHELF & 1 ADJUSTABLE SHELF IN EACH CABINET.

|   |         |         |         |     |      |       |       |       |       |
|---|---------|---------|---------|-----|------|-------|-------|-------|-------|
| 388-6524COCWR-24  | \$1,813 | \$1,922 | \$1,052 | 196 | 26   | 23.75 | 23.75 | 64.5  | 64.5  |
| 388-6530COCWR-24  | \$1,907 | \$2,021 | \$1,076 | 266 | 32.8 | 29.5  | 23.75 | 64.5  | 64.5  |
| 388-7224COCWR-24  | \$2,091 | \$2,216 | \$1,117 | 248 | 29.3 | 23.75 | 23.75 | 71.5  | 71.5  |
| 388-7230COCWR-24  | \$2,186 | \$2,317 | \$1,124 | 249 | 36.3 | 29.5  | 23.75 | 71.5  | 71.5  |
| 1 FIXED SHELF & 2 ADJUSTABLE SHELVES IN UPPER CABINET, 1 FIXED SHELF & 1 ADJUSTABLE SHELF IN LOWER CABINET. |         |         |         |     |      |       |       |       |       |
| 388-7724COCWR-24  | \$2,172 | \$2,302 | \$1,177 | 225 | 30   | 23.75 | 23.75 | 76.25 | 76.25 |
| 388-7730COCWR-24  | \$2,294 | \$2,432 | \$1,183 | 255 | 38   | 29.5  | 23.75 | 76.25 | 76.25 |
| 388-8424COCWR-24  | \$2,310 | \$2,449 | \$1,249 | 240 | 35   | 23.75 | 23.75 | 83.25 | 83.25 |
| 388-8430COCWR-24  | \$2,431 | \$2,577 | \$1,249 | 270 | 42   | 29.5  | 23.75 | 83.25 | 83.25 |

- 20" DEPTH AVAILABLE. REPLACE -24 W/ -20 WHEN ORDERING & USE -24 PRICE. COAT ROD REPLACED W/ COAT HOOKS IN 20" UNITS.
- TO ADD BOOTSHELF, ADD -BS TO SKU. UP-CHARGES APPLY SEE [388/600-5](#)

- UPPER CABINET DOOR LOCK OPTIONAL, ADD AN '-L' TO ITEM # & ADD UPCHARGE OF \$76  
**EXAMPLE:** 388-6524COCWL-24 - L

### \*OPTIONAL ALUMINUM GLAZED DOORS\*

- SELECT CLEAR (CL), FROSTED (FR) OR BRONZE (BR) PLEXIGLASS
- AGD DOORS INCLUDE SILVER FINISH BAR HANDLES. REFER TO [100-3](#) FOR OTHER HANDLE OPTIONS
- THE PRICE SHOWN FOR AGD DOORS IS AN UP-CHARGE THAT MUST BE ADDED TO THE BASE PRICE OF THE UNIT IT GOES ON.

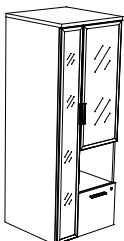

388-6524COFWL-24 -AGD-FR

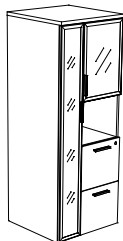

388-6524COFFWL-24-AGD-FR

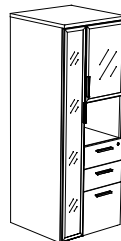

388-6524COUFWL-24-AGD-FR

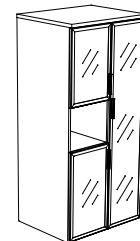

388-6530COCWR-24 -AGD-FR

| MODEL | 388  |      | 600       |      | AGD | WEIGHT | CUBE | W | D | 388             |    | 600 |    |
|-------|------|------|-----------|------|-----|--------|------|---|---|-----------------|----|-----|----|
|       | LIST | LIST | LIST      | LIST |     |        |      |   |   | H               | H  |     |    |
|       | 1"   | 1½"  | UP CHARGE | LBS  |     |        |      |   |   | FT <sup>3</sup> | IN | IN  | 1" |

**OPEN WARDROBE STORAGE**

OPEN SHELVES/FILE/WARDROBE LEFT

INCLUDES COAT ROD & HAT SHELF. LOCKING FILE DRAWER & WARDROBE. 1 FIXED SHELF & 2 ADJUSTABLE SHELVES

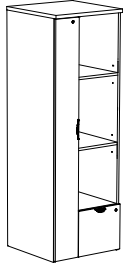

388-6524OFWL-24

|                                      |         |         |       |     |      |       |       |       |       |
|--------------------------------------|---------|---------|-------|-----|------|-------|-------|-------|-------|
| 388-6524OFWL-24                      | \$1,663 | \$1,763 | \$632 | 199 | 26   | 23.75 | 23.75 | 64.5  | 64.5  |
| 388-6530OFWL-24                      | \$1,706 | \$1,808 | \$671 | 222 | 32.8 | 29.5  | 23.75 | 64.5  | 64.5  |
| 1 FIXED SHELF & 3 ADJUSTABLE SHELVES |         |         |       |     |      |       |       |       |       |
| 388-7224OFWL-24                      | \$1,948 | \$2,065 | \$700 | 228 | 29.3 | 23.75 | 23.75 | 71.5  | 71.5  |
| 388-7230OFWL-24                      | \$2,090 | \$2,215 | \$744 | 249 | 36.3 | 29.5  | 23.75 | 71.5  | 71.5  |
| 388-7724OFWL-24                      | \$2,002 | \$2,122 | \$729 | 237 | 30   | 23.75 | 23.75 | 76.25 | 76.25 |
| 388-7730OFWL-24                      | \$2,169 | \$2,299 | \$802 | 252 | 38   | 29.5  | 23.75 | 76.25 | 76.25 |
| 1 FIXED SHELF & 4 ADJUSTABLE SHELVES |         |         |       |     |      |       |       |       |       |
| 388-8424OFWL-24                      | \$2,140 | \$2,268 | \$829 | 240 | 35   | 23.75 | 23.75 | 83.25 | 83.25 |
| 388-8430OFWL-24                      | \$2,307 | \$2,445 | \$901 | 270 | 42   | 29.5  | 23.75 | 83.25 | 83.25 |

OPEN SHELVES/FILE/WARDROBE RIGHT

INCLUDES COAT ROD & HAT SHELF. LOCKING FILE DRAWER & WARDROBE. 1 FIXED SHELF & 2 ADJUSTABLE SHELVES

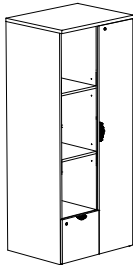

388-6530OFWR-24

|                                      |         |         |       |     |      |       |       |       |       |
|--------------------------------------|---------|---------|-------|-----|------|-------|-------|-------|-------|
| 388-6524OFWR-24                      | \$1,663 | \$1,763 | \$632 | 199 | 26   | 23.75 | 23.75 | 64.5  | 64.5  |
| 388-6530OFWR-24                      | \$1,706 | \$1,808 | \$671 | 232 | 32.8 | 29.5  | 23.75 | 64.5  | 64.5  |
| 1 FIXED SHELF & 3 ADJUSTABLE SHELVES |         |         |       |     |      |       |       |       |       |
| 388-7224OFWR-24                      | \$1,948 | \$2,065 | \$700 | 228 | 29.3 | 23.75 | 23.75 | 71.5  | 71.5  |
| 388-7230OFWR-24                      | \$2,090 | \$2,215 | \$744 | 249 | 36.3 | 29.5  | 23.75 | 71.5  | 71.5  |
| 388-7724OFWR-24                      | \$2,002 | \$2,122 | \$729 | 237 | 30   | 23.75 | 23.75 | 76.25 | 76.25 |
| 388-7730OFWR-24                      | \$2,169 | \$2,299 | \$802 | 252 | 38   | 29.5  | 23.75 | 76.25 | 76.25 |
| 1 FIXED SHELF & 4 ADJUSTABLE SHELVES |         |         |       |     |      |       |       |       |       |
| 388-8424OFWR-24                      | \$2,140 | \$2,268 | \$829 | 240 | 35   | 23.75 | 23.75 | 83.25 | 83.25 |
| 388-8430OFWR-24                      | \$2,307 | \$2,445 | \$901 | 270 | 42   | 29.5  | 23.75 | 83.25 | 83.25 |

- 20" DEPTH AVAILABLE. REPLACE -24 W/ -20 WHEN ORDERING & USE -24 PRICE. COAT ROD REPLACED W/ COAT HOOKS IN 20" UNITS.
- TO ADD BOOTSHELF, ADD -BS TO SKU. UP-CHARGES APPLY SEE [388/600-5](#)

**OPEN WARDROBE STORAGE**

OPEN SHELVES/FILE/FILE/ WARDROBE LEFT

INCLUDES COAT ROD & HAT SHELF. LOCKING DRAWERS & WARDROBE. 1 FIXED SHELF & 1 ADJUSTABLE SHELF

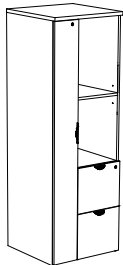

388-6524OFFWL-24

|                                      |         |         |       |     |      |       |       |       |       |
|--------------------------------------|---------|---------|-------|-----|------|-------|-------|-------|-------|
| 388-6524OFFWL-24                     | \$1,990 | \$2,109 | \$632 | 201 | 26   | 23.75 | 23.75 | 64.5  | 64.5  |
| 388-6530OFFWL-24                     | \$2,000 | \$2,120 | \$671 | 232 | 32.8 | 29.5  | 23.75 | 64.5  | 64.5  |
| 1 FIXED SHELF & 2 ADJUSTABLE SHELVES |         |         |       |     |      |       |       |       |       |
| 388-7224OFFWL-24                     | \$2,051 | \$2,174 | \$700 | 238 | 29.3 | 23.75 | 23.75 | 71.5  | 71.5  |
| 388-7230OFFWL-24                     | \$2,100 | \$2,226 | \$744 | 251 | 36.3 | 29.5  | 23.75 | 71.5  | 71.5  |
| 388-7724OFFWL-24                     | \$2,117 | \$2,244 | \$729 | 251 | 30   | 23.75 | 23.75 | 76.25 | 76.25 |
| 388-7730OFFWL-24                     | \$2,171 | \$2,301 | \$802 | 277 | 38   | 29.5  | 23.75 | 76.25 | 76.25 |
| 1 FIXED SHELF & 3 ADJUSTABLE SHELVES |         |         |       |     |      |       |       |       |       |
| 388-8424OFFWL-24                     | \$2,238 | \$2,372 | \$829 | 271 | 35   | 23.75 | 23.75 | 83.25 | 83.25 |
| 388-8430OFFWL-24                     | \$2,255 | \$2,390 | \$901 | 297 | 42   | 29.5  | 23.75 | 83.25 | 83.25 |

# 388/600 TALL WARDROBE CABINETS

| MODEL | 388  |      | 600       |      | AGD | WEIGHT | CUBE | W | D | 388 |    | 600 |    |
|-------|------|------|-----------|------|-----|--------|------|---|---|-----|----|-----|----|
|       | LIST | LIST | LIST      | LIST |     |        |      |   |   | H   | H  |     |    |
|       | 1"   | 1½"  | UP CHARGE | LBS  |     |        |      |   |   | FT³ | IN | IN  | 1" |

## OPEN SHELVES/FILE/FILE/ WARDROBE RIGHT

INCLUDES COAT ROD & HAT SHELF. LOCKING DRAWERS & WARDROBE. 1 FIXED SHELF & 1 ADJUSTABLE SHELF

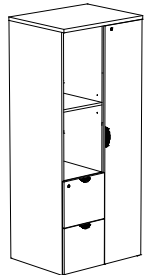

388-6530OFFWR-24

|                         |                |                |              |            |             |              |              |             |             |
|-------------------------|----------------|----------------|--------------|------------|-------------|--------------|--------------|-------------|-------------|
| <b>388-6524OFFWR-24</b> | <b>\$1,990</b> | <b>\$2,109</b> | <i>\$632</i> | <b>201</b> | <b>26</b>   | <b>23.75</b> | <b>23.75</b> | <b>64.5</b> | <b>64.5</b> |
| <b>388-6530OFFWR-24</b> | <b>\$2,000</b> | <b>\$2,120</b> | <i>\$671</i> | <b>232</b> | <b>32.8</b> | <b>29.5</b>  | <b>23.75</b> | <b>64.5</b> | <b>64.5</b> |

1 FIXED SHELF & 2 ADJUSTABLE SHELVES

|                         |                |                |              |            |             |              |              |              |              |
|-------------------------|----------------|----------------|--------------|------------|-------------|--------------|--------------|--------------|--------------|
| <b>388-7224OFFWR-24</b> | <b>\$2,051</b> | <b>\$2,174</b> | <i>\$700</i> | <b>238</b> | <b>29.3</b> | <b>23.75</b> | <b>23.75</b> | <b>71.5</b>  | <b>71.5</b>  |
| <b>388-7230OFFWR-24</b> | <b>\$2,100</b> | <b>\$2,226</b> | <i>\$744</i> | <b>251</b> | <b>36.3</b> | <b>29.5</b>  | <b>23.75</b> | <b>71.5</b>  | <b>71.5</b>  |
| <b>388-7724OFFWR-24</b> | <b>\$2,117</b> | <b>\$2,244</b> | <i>\$729</i> | <b>251</b> | <b>30</b>   | <b>23.75</b> | <b>23.75</b> | <b>76.25</b> | <b>76.25</b> |
| <b>388-7730OFFWR-24</b> | <b>\$2,171</b> | <b>\$2,301</b> | <i>\$802</i> | <b>277</b> | <b>38</b>   | <b>29.5</b>  | <b>23.75</b> | <b>76.25</b> | <b>76.25</b> |

1 FIXED SHELF & 3 ADJUSTABLE SHELVES

|                         |                |                |              |            |           |              |              |              |              |
|-------------------------|----------------|----------------|--------------|------------|-----------|--------------|--------------|--------------|--------------|
| <b>388-8424OFFWR-24</b> | <b>\$2,238</b> | <b>\$2,372</b> | <i>\$829</i> | <b>271</b> | <b>35</b> | <b>23.75</b> | <b>23.75</b> | <b>83.25</b> | <b>83.25</b> |
| <b>388-8430OFFWR-24</b> | <b>\$2,255</b> | <b>\$2,390</b> | <i>\$901</i> | <b>297</b> | <b>42</b> | <b>29.5</b>  | <b>23.75</b> | <b>83.25</b> | <b>83.25</b> |

- 20" DEPTH AVAILABLE. REPLACE -24 W/ -20 WHEN ORDERING & USE -24 PRICE. COAT ROD REPLACED W/ COAT HOOKS IN 20" UNITS.
- TO ADD BOOTSHELF, ADD -BS TO SKU. UP-CHARGES APPLY SEE [388/600-5](#)

## OPEN WARDROBE STORAGE

OPEN SHELVES/BOX/BOX/FILE/WARDROBE LEFT

INCLUDES COAT ROD & HAT SHELF. LOCKING DRAWERS & WARDROBE. 1 FIXED SHELF & 1 ADJUSTABLE SHELF.

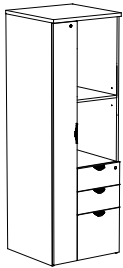

388-6524OUFWL-24

|                         |                |                |              |            |             |              |              |             |             |
|-------------------------|----------------|----------------|--------------|------------|-------------|--------------|--------------|-------------|-------------|
| <b>388-6524OUFWL-24</b> | <b>\$1,920</b> | <b>\$2,035</b> | <i>\$632</i> | <b>208</b> | <b>26</b>   | <b>23.75</b> | <b>23.75</b> | <b>64.5</b> | <b>64.5</b> |
| <b>388-6530OUFWL-24</b> | <b>\$2,012</b> | <b>\$2,133</b> | <i>\$671</i> | <b>229</b> | <b>32.3</b> | <b>29.5</b>  | <b>23.75</b> | <b>64.5</b> | <b>64.5</b> |

1 FIXED SHELF & 2 ADJUSTABLE SHELVES.

|                         |                |                |              |            |             |              |              |              |              |
|-------------------------|----------------|----------------|--------------|------------|-------------|--------------|--------------|--------------|--------------|
| <b>388-7224OUFWL-24</b> | <b>\$1,953</b> | <b>\$2,070</b> | <i>\$700</i> | <b>241</b> | <b>29.3</b> | <b>23.75</b> | <b>23.75</b> | <b>71.5</b>  | <b>71.5</b>  |
| <b>388-7230OUFWL-24</b> | <b>\$2,131</b> | <b>\$2,259</b> | <i>\$744</i> | <b>272</b> | <b>36.3</b> | <b>29.5</b>  | <b>23.75</b> | <b>71.5</b>  | <b>71.5</b>  |
| <b>388-7724OUFWL-24</b> | <b>\$2,014</b> | <b>\$2,135</b> | <i>\$729</i> | <b>251</b> | <b>30</b>   | <b>23.75</b> | <b>23.75</b> | <b>76.25</b> | <b>76.25</b> |
| <b>388-7730OUFWL-24</b> | <b>\$2,234</b> | <b>\$2,368</b> | <i>\$802</i> | <b>277</b> | <b>38</b>   | <b>29.5</b>  | <b>23.75</b> | <b>76.25</b> | <b>76.25</b> |

1 FIXED SHELF & 3 ADJUSTABLE SHELVES.

|                         |                |                |              |            |           |              |              |              |              |
|-------------------------|----------------|----------------|--------------|------------|-----------|--------------|--------------|--------------|--------------|
| <b>388-8424OUFWL-24</b> | <b>\$2,152</b> | <b>\$2,281</b> | <i>\$829</i> | <b>271</b> | <b>35</b> | <b>23.75</b> | <b>23.75</b> | <b>83.25</b> | <b>83.25</b> |
| <b>388-8430OUFWL-24</b> | <b>\$2,372</b> | <b>\$2,514</b> | <i>\$901</i> | <b>297</b> | <b>42</b> | <b>29.5</b>  | <b>23.75</b> | <b>83.25</b> | <b>83.25</b> |

## OPEN SHELVES/BOX/BOX/FILE/WARDROBE RIGHT

INCLUDES COAT ROD & HAT SHELF. LOCKING DRAWERS & WARDROBE. 1 FIXED SHELF & 1 ADJUSTABLE SHELF.

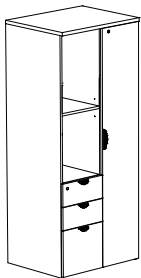

388-6530OUFWR-24

|                         |                |                |              |            |             |              |              |             |             |
|-------------------------|----------------|----------------|--------------|------------|-------------|--------------|--------------|-------------|-------------|
| <b>388-6524OUFWR-24</b> | <b>\$1,920</b> | <b>\$2,035</b> | <i>\$632</i> | <b>208</b> | <b>26</b>   | <b>23.75</b> | <b>23.75</b> | <b>64.5</b> | <b>64.5</b> |
| <b>388-6530OUFWR-24</b> | <b>\$2,012</b> | <b>\$2,133</b> | <i>\$671</i> | <b>229</b> | <b>32.3</b> | <b>29.5</b>  | <b>23.75</b> | <b>64.5</b> | <b>64.5</b> |

1 FIXED SHELF & 2 ADJUSTABLE SHELVES.

|                         |                |                |              |            |             |              |              |              |              |
|-------------------------|----------------|----------------|--------------|------------|-------------|--------------|--------------|--------------|--------------|
| <b>388-7224OUFWR-24</b> | <b>\$1,953</b> | <b>\$2,070</b> | <i>\$700</i> | <b>241</b> | <b>29.3</b> | <b>23.75</b> | <b>23.75</b> | <b>71.5</b>  | <b>71.5</b>  |
| <b>388-7230OUFWR-24</b> | <b>\$2,131</b> | <b>\$2,259</b> | <i>\$744</i> | <b>272</b> | <b>36.3</b> | <b>29.5</b>  | <b>23.75</b> | <b>71.5</b>  | <b>71.5</b>  |
| <b>388-7724OUFWR-24</b> | <b>\$2,014</b> | <b>\$2,135</b> | <i>\$729</i> | <b>251</b> | <b>30</b>   | <b>23.75</b> | <b>23.75</b> | <b>76.25</b> | <b>76.25</b> |
| <b>388-7730OUFWR-24</b> | <b>\$2,234</b> | <b>\$2,368</b> | <i>\$802</i> | <b>277</b> | <b>38</b>   | <b>29.5</b>  | <b>23.75</b> | <b>76.25</b> | <b>76.25</b> |

1 FIXED SHELF & 3 ADJUSTABLE SHELVES.

|                         |                |                |              |            |           |              |              |              |              |
|-------------------------|----------------|----------------|--------------|------------|-----------|--------------|--------------|--------------|--------------|
| <b>388-8424OUFWR-24</b> | <b>\$2,152</b> | <b>\$2,281</b> | <i>\$829</i> | <b>271</b> | <b>35</b> | <b>23.75</b> | <b>23.75</b> | <b>83.25</b> | <b>83.25</b> |
| <b>388-8430OUFWR-24</b> | <b>\$2,372</b> | <b>\$2,514</b> | <i>\$901</i> | <b>297</b> | <b>42</b> | <b>29.5</b>  | <b>23.75</b> | <b>83.25</b> | <b>83.25</b> |

- 20" DEPTH AVAILABLE. REPLACE -24 W/ -20 WHEN ORDERING & USE -24 PRICE. COAT ROD REPLACED W/ COAT HOOKS IN 20" UNITS.
- TO ADD BOOTSHELF, ADD -BS TO SKU. UP-CHARGES APPLY SEE [388/600-5](#)

| MODEL | 388  |      | 600       |      | AGD | WEIGHT | CUBE | W | D | 388 |    | 600 |    |
|-------|------|------|-----------|------|-----|--------|------|---|---|-----|----|-----|----|
|       | LIST | LIST | LIST      | LIST |     |        |      |   |   | H   | H  |     |    |
|       | 1"   | 1½"  | UP CHARGE | LBS  |     |        |      |   |   | FT³ | IN | IN  | 1" |

**OPEN WARDROBE STORAGE**

OPEN SHELVES/CABINET/WARDROBE LEFT. INCLUDES COAT ROD & HAT SHELF. LOWER CABINET & WARDROBE LOCK. 1 FIXED SHELF & 1 ADJUSTABLE SHELF IN UPPER CUBBY, 1 FIXED SHELF & 1 ADJUSTABLE SHELF IN LOWER CABINET.

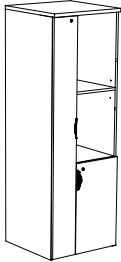

388-6524OCWL-24

|   |         |         |       |     |      |       |       |       |       |
|---|---------|---------|-------|-----|------|-------|-------|-------|-------|
| 388-6524OCWL-24   | \$1,590 | \$1,685 | \$675 | 182 | 26   | 23.75 | 23.75 | 64.5  | 64.5  |
| 388-6530OCWL-24   | \$1,727 | \$1,831 | \$724 | 232 | 32.8 | 29.5  | 23.75 | 64.5  | 64.5  |
| 1 FIXED SHELF & 2 ADJUSTABLE SHELVES IN UPPER CUBBY, 1 FIXED SHELF & 1 ADJUSTABLE SHELF IN LOWER CABINET. |         |         |       |     |      |       |       |       |       |
| 388-7224OCWL-24   | \$1,762 | \$1,868 | \$731 | 214 | 29.3 | 23.75 | 23.75 | 71.5  | 71.5  |
| 388-7230OCWL-24   | \$1,852 | \$1,963 | \$806 | 235 | 36.3 | 29.5  | 23.75 | 71.5  | 71.5  |
| 388-7724OCWL-24   | \$1,866 | \$1,978 | \$782 | 240 | 30   | 23.75 | 23.75 | 76.25 | 76.25 |
| 388-7730OCWL-24   | \$1,951 | \$2,068 | \$865 | 254 | 38   | 29.5  | 23.75 | 76.25 | 76.25 |
| 1 FIXED SHELF & 3 ADJUSTABLE SHELVES IN UPPER CUBBY, 1 FIXED SHELF & 1 ADJUSTABLE SHELF IN LOWER CABINET. |         |         |       |     |      |       |       |       |       |
| 388-8424OCWL-24   | \$2,002 | \$2,122 | \$882 | 244 | 35   | 23.75 | 23.75 | 83.25 | 83.25 |
| 388-8430OCWL-24   | \$2,089 | \$2,214 | \$965 | 273 | 42   | 29.5  | 23.75 | 83.25 | 83.25 |

OPEN SHELVES/CABINET/WARDROBE RIGHT. INCLUDES COAT ROD & HAT SHELF. LOWER CABINET & WARDROBE LOCK. 1 FIXED SHELF & 1 ADJUSTABLE SHELF IN UPPER CUBBY, 1 FIXED SHELF & 1 ADJUSTABLE SHELF IN LOWER CABINET.

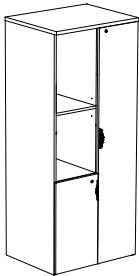

388-6530OCWR-24

|   |         |         |       |     |      |       |       |       |       |
|---|---------|---------|-------|-----|------|-------|-------|-------|-------|
| 388-6524OCWR-24   | \$1,590 | \$1,685 | \$675 | 182 | 26   | 23.75 | 23.75 | 64.5  | 64.5  |
| 388-6530OCWR-24   | \$1,727 | \$1,831 | \$724 | 232 | 32.8 | 29.5  | 23.75 | 64.5  | 64.5  |
| 1 FIXED SHELF & 2 ADJUSTABLE SHELVES IN UPPER CUBBY, 1 FIXED SHELF & 1 ADJUSTABLE SHELF IN LOWER CABINET. |         |         |       |     |      |       |       |       |       |
| 388-7224OCWR-24   | \$1,762 | \$1,868 | \$731 | 214 | 29.3 | 23.75 | 23.75 | 71.5  | 71.5  |
| 388-7230OCWR-24   | \$1,852 | \$1,963 | \$806 | 235 | 36.3 | 29.5  | 23.75 | 71.5  | 71.5  |
| 388-7724OCWR-24   | \$1,866 | \$1,978 | \$782 | 240 | 30   | 23.75 | 23.75 | 76.25 | 76.25 |
| 388-7730OCWR-24   | \$1,951 | \$2,068 | \$865 | 254 | 38   | 29.5  | 23.75 | 76.25 | 76.25 |
| 1 FIXED SHELF & 3 ADJUSTABLE SHELVES IN UPPER CUBBY, 1 FIXED SHELF & 1 ADJUSTABLE SHELF IN LOWER CABINET. |         |         |       |     |      |       |       |       |       |
| 388-8424OCWR-24   | \$2,002 | \$2,122 | \$882 | 244 | 35   | 23.75 | 23.75 | 83.25 | 83.25 |
| 388-8430OCWR-24   | \$2,089 | \$2,214 | \$965 | 273 | 42   | 29.5  | 23.75 | 83.25 | 83.25 |

- 20" DEPTH AVAILABLE. REPLACE -24 W/ -20 WHEN ORDERING & USE -24 PRICE. COAT ROD REPLACED W/ COAT HOOKS IN 20" UNITS.
- TO ADD BOOTSHELF, ADD -BS TO SKU. UP-CHARGES APPLY SEE [388/600-5](#)

**OPEN WARDROBE STORAGE**

OPEN SHELVES/WARDROBE LEFT

INCLUDES COAT ROD & HAT SHELF. LOCKING WARDROBE. 2 FIXED SHELVES & 2 ADJUSTABLE SHELVES.



388-6524OWL-24

|   |         |         |       |     |      |       |       |       |       |
|---|---------|---------|-------|-----|------|-------|-------|-------|-------|
| 388-6524OWL-24                          | \$1,408 | \$1,492 | \$632 | 200 | 26   | 23.75 | 23.75 | 64.5  | 64.5  |
| 388-6530OWL-24                          | \$1,557 | \$1,650 | \$671 | 222 | 32.8 | 29.5  | 23.75 | 64.5  | 64.5  |
| 2 FIXED SHELVES & 3 ADJUSTABLE SHELVES. |         |         |       |     |      |       |       |       |       |
| 388-7224OWL-24                          | \$1,611 | \$1,708 | \$700 | 233 | 30   | 23.75 | 23.75 | 71.5  | 71.5  |
| 388-7230OWL-24                          | \$1,754 | \$1,859 | \$744 | 225 | 36.3 | 29.5  | 23.75 | 71.5  | 71.5  |
| 388-7724OWL-24                          | \$1,684 | \$1,785 | \$729 | 233 | 30   | 23.75 | 23.75 | 76.25 | 76.25 |
| 388-7730OWL-24                          | \$1,866 | \$1,978 | \$802 | 241 | 38   | 29.5  | 23.75 | 76.25 | 76.25 |
| 2 FIXED SHELVES & 4 ADJUSTABLE SHELVES. |         |         |       |     |      |       |       |       |       |
| 388-8424OWL-24                          | \$1,822 | \$1,931 | \$829 | 234 | 35   | 23.75 | 23.75 | 83.25 | 83.25 |
| 388-8430OWL-24                          | \$2,002 | \$2,122 | \$901 | 262 | 42   | 29.5  | 23.75 | 83.25 | 83.25 |

# 388/600 TALL WARDROBE CABINETS

| MODEL | 388  |      | 600       |      | AGD | WEIGHT<br>LBS | CUBE<br>FT <sup>3</sup> | W<br>IN | D<br>IN | 388 |     | 600 |  |
|-------|------|------|-----------|------|-----|---------------|-------------------------|---------|---------|-----|-----|-----|--|
|       | LIST | LIST | LIST      | LIST |     |               |                         |         |         | H   | H   |     |  |
|       | 1"   | 1½"  | UP CHARGE |      |     |               |                         |         |         | 1"  | 1½" |     |  |

## OPEN SHELVES/WARDROBE RIGHT

INCLUDES COAT ROD & HAT SHELF. LOCKING WARDROBE. 2 FIXED SHELVES & 2 ADJUSTABLE SHELVES.

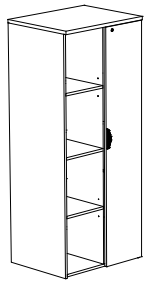

388-6524OWR-24

|                |         |         |       |     |      |       |       |      |      |
|----------------|---------|---------|-------|-----|------|-------|-------|------|------|
| 388-6524OWR-24 | \$1,408 | \$1,492 | \$632 | 200 | 26   | 23.75 | 23.75 | 64.5 | 64.5 |
| 388-6530OWR-24 | \$1,557 | \$1,650 | \$671 | 222 | 32.8 | 29.5  | 23.75 | 64.5 | 64.5 |

2 FIXED SHELVES & 3 ADJUSTABLE SHELVES.

|                |         |         |       |     |      |       |       |       |       |
|----------------|---------|---------|-------|-----|------|-------|-------|-------|-------|
| 388-7224OWR-24 | \$1,611 | \$1,708 | \$700 | 233 | 30   | 23.75 | 23.75 | 71.5  | 71.5  |
| 388-7230OWR-24 | \$1,754 | \$1,859 | \$744 | 225 | 36.3 | 29.5  | 23.75 | 71.5  | 71.5  |
| 388-7724OWR-24 | \$1,684 | \$1,785 | \$729 | 233 | 30   | 23.75 | 23.75 | 76.25 | 76.25 |
| 388-7730OWR-24 | \$1,866 | \$1,978 | \$802 | 241 | 38   | 29.5  | 23.75 | 76.25 | 76.25 |

2 FIXED SHELVES & 4 ADJUSTABLE SHELVES.

|                |         |         |       |     |    |       |       |       |       |
|----------------|---------|---------|-------|-----|----|-------|-------|-------|-------|
| 388-8424OWR-24 | \$1,822 | \$1,931 | \$829 | 234 | 35 | 23.75 | 23.75 | 83.25 | 83.25 |
| 388-8430OWR-24 | \$2,002 | \$2,122 | \$901 | 262 | 42 | 29.5  | 23.75 | 83.25 | 83.25 |

- 20" DEPTH AVAILABLE. REPLACE -24 W/ -20 WHEN ORDERING & USE -24 PRICE. COAT ROD REPLACED W/ COAT HOOKS IN 20" UNITS.
- TO ADD BOOTSHelf, ADD -BS TO SKU. UP-CHARGES APPLY SEE [388/600-5](#)

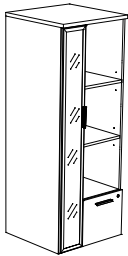

388-6524OFWL-24-AGD-FR

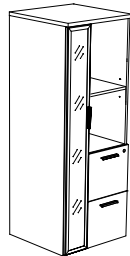

388-6524OFFWL-24-AGD FR

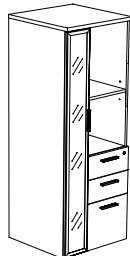

388-6524OUFWL-24-AGD-FR

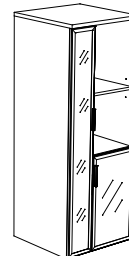

388-6524OCWL-24-AGD-FR

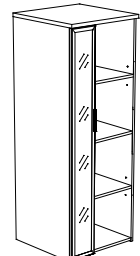

388-6524OWR-24-AGD-FR

## WARDROBE STORAGE

INCLUDES COAT ROD, HAT SHELF. WARDROBE & DRAWERS ARE LOCKING. OPTIONAL LOCK ON CABINET DOOR. CABINET/BOX/BOX/FILE WARDROBE LEFT. 1 FIXED SHELF & 1 ADJUSTABLE SHELF.

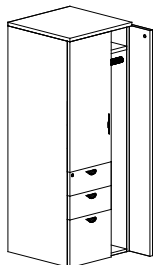

388-6524CUFWL-24

|                  |         |         |         |     |    |       |       |      |      |
|------------------|---------|---------|---------|-----|----|-------|-------|------|------|
| 388-6524CUFWL-24 | \$2,281 | \$2,418 | \$1,031 | 240 | 26 | 23.75 | 23.75 | 64.5 | 64.5 |
|------------------|---------|---------|---------|-----|----|-------|-------|------|------|

1 FIXED SHELF & 2 ADJUSTABLE SHELVES.

|                  |         |         |         |     |    |       |       |       |       |
|------------------|---------|---------|---------|-----|----|-------|-------|-------|-------|
| 388-7224CUFWL-24 | \$2,467 | \$2,615 | \$1,188 | 248 | 27 | 23.75 | 23.75 | 71.5  | 71.5  |
| 388-7724CUFWL-24 | \$2,635 | \$2,793 | \$1,213 | 260 | 30 | 23.75 | 23.75 | 76.25 | 76.25 |

1 FIXED SHELF & 3 ADJUSTABLE SHELVES.

|                  |         |         |         |     |    |       |       |       |       |
|------------------|---------|---------|---------|-----|----|-------|-------|-------|-------|
| 388-8424CUFWL-24 | \$2,865 | \$3,037 | \$1,310 | 281 | 35 | 23.75 | 23.75 | 83.25 | 83.25 |
|------------------|---------|---------|---------|-----|----|-------|-------|-------|-------|

CABINET/BOX/BOX/FILE WARDROBE RIGHT. 1 FIXED SHELF & 1 ADJUSTABLE SHELF.

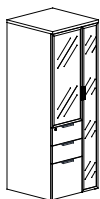

388-6524CUFWL-24- AGD-FR

|                  |         |         |         |     |    |       |       |      |      |
|------------------|---------|---------|---------|-----|----|-------|-------|------|------|
| 388-6524CUFWL-24 | \$2,281 | \$2,418 | \$1,031 | 240 | 26 | 23.75 | 23.75 | 64.5 | 64.5 |
|------------------|---------|---------|---------|-----|----|-------|-------|------|------|

1 FIXED SHELF & 2 ADJUSTABLE SHELVES.

|                  |         |         |         |     |    |       |       |       |       |
|------------------|---------|---------|---------|-----|----|-------|-------|-------|-------|
| 388-7224CUFWL-24 | \$2,467 | \$2,615 | \$1,188 | 248 | 27 | 23.75 | 23.75 | 71.5  | 71.5  |
| 388-7724CUFWL-24 | \$2,635 | \$2,793 | \$1,213 | 260 | 30 | 23.75 | 23.75 | 76.25 | 76.25 |

1 FIXED SHELF & 3 ADJUSTABLE SHELVES.

|                  |         |         |         |     |    |       |       |       |       |
|------------------|---------|---------|---------|-----|----|-------|-------|-------|-------|
| 388-8424CUFWL-24 | \$2,865 | \$3,037 | \$1,310 | 281 | 35 | 23.75 | 23.75 | 83.25 | 83.25 |
|------------------|---------|---------|---------|-----|----|-------|-------|-------|-------|

- 20" DEPTH AVAILABLE. REPLACE -24 W/ -20 WHEN ORDERING & USE -24 PRICE. COAT ROD REPLACED W/ COAT HOOKS IN 20" UNITS.
- TO ADD BOOTSHelf, ADD -BS TO SKU. UP-CHARGES APPLY SEE [388/600-5](#)



| MODEL | 388  | 600  | WEIGHT | CUBE | W | D | 388 | 600 |
|-------|------|------|--------|------|---|---|-----|-----|
|       | LIST | LIST |        |      |   |   | H   | H   |
|       | 1"   | 1½"  |        |      |   |   | 1"  | 1½" |

WHEN SIZING HUTCHES, OVERALL CAVITY CLEARANCE HEIGHT OF **600 SERIES** HUTCHES REDUCES BY 1" TO ACCOUNT FOR INCREASED THICKNESS OF **600 SERIES** WORKSURFACE TOP & INCREASED THICKNESS OF **600 SERIES** HUTCH TOP. TO ENSURE TOP ALIGNMENT, ORDER LIKE SERIES.

**OPEN HUTCH - 36" HIGH**

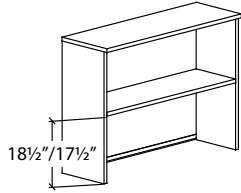

|           |       |       |    |     |       |    |      |    |
|-----------|-------|-------|----|-----|-------|----|------|----|
| 388-3630H | \$553 | \$630 | 69 | 3   | 29.5  | 16 | 35.5 | 35 |
| 388-3636H | \$601 | \$685 | 71 | 3   | 35.5  | 16 | 35.5 | 35 |
| 388-3642H | \$649 | \$740 | 79 | 3.5 | 41.5  | 16 | 35.5 | 35 |
| 388-3648H | \$717 | \$817 | 87 | 3.5 | 47.25 | 16 | 35.5 | 35 |

W/ DIVIDER

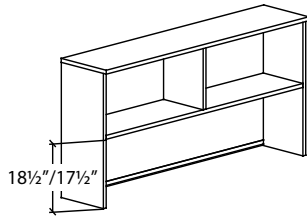

|           |         |         |     |     |       |    |      |    |
|-----------|---------|---------|-----|-----|-------|----|------|----|
| 388-3654H | \$779   | \$888   | 96  | 4   | 53.25 | 16 | 35.5 | 35 |
| 388-3660H | \$792   | \$903   | 105 | 4   | 59.25 | 16 | 35.5 | 35 |
| 388-3666H | \$840   | \$958   | 120 | 4.5 | 65    | 16 | 35.5 | 35 |
| 388-3672H | \$990   | \$1,129 | 135 | 5   | 71    | 16 | 35.5 | 35 |
| 388-3678H | \$1,077 | \$1,228 | 150 | 5.5 | 77    | 16 | 35.5 | 35 |
| 388-3684H | \$1,332 | \$1,518 | 165 | 6   | 82.75 | 16 | 35.5 | 35 |

**RTA**

NOTES:

- 36" HUTCHES ALIGN WITH 65" TALL STORAGE
- TO ORDER OPTIONAL VALANCE ADD -V TO SKU AND AN UP-CHARGE OF **\$218**  
**EXAMPLE: 600-3648H-V**

**OPEN HUTCHES - 43" HIGH**

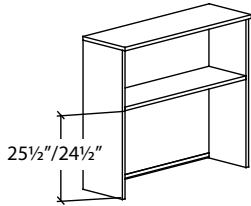

|           |       |       |     |     |       |    |      |    |
|-----------|-------|-------|-----|-----|-------|----|------|----|
| 388-4330H | \$621 | \$708 | 81  | 3.5 | 29.5  | 16 | 42.5 | 42 |
| 388-4336H | \$676 | \$771 | 83  | 3.5 | 35.5  | 16 | 42.5 | 42 |
| 388-4342H | \$744 | \$848 | 92  | 4   | 41.5  | 16 | 42.5 | 42 |
| 388-4348H | \$783 | \$893 | 102 | 4   | 47.25 | 16 | 42.5 | 42 |

W/ DIVIDER

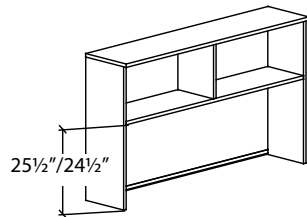

|           |         |         |     |     |       |    |      |    |
|-----------|---------|---------|-----|-----|-------|----|------|----|
| 388-4354H | \$853   | \$972   | 113 | 4.5 | 53.25 | 16 | 42.5 | 42 |
| 388-4360H | \$921   | \$1,050 | 123 | 5   | 59.25 | 16 | 42.5 | 42 |
| 388-4366H | \$950   | \$1,083 | 141 | 5   | 65    | 16 | 42.5 | 42 |
| 388-4372H | \$1,084 | \$1,236 | 158 | 6   | 71    | 16 | 42.5 | 42 |
| 388-4378H | \$1,332 | \$1,518 | 170 | 6.5 | 77    | 16 | 42.5 | 42 |
| 388-4384H | \$1,435 | \$1,636 | 185 | 7   | 82.75 | 16 | 42.5 | 42 |

**RTA**

- TO ORDER OPTIONAL VALANCE ADD -V TO SKU AND AN UP-CHARGE OF **\$218**  
**EXAMPLE: 600-4348H-V**

**RECORD DIVIDERS**

OPTIONAL RECORD DIVIDERS AVAILABLE. SET OF 6

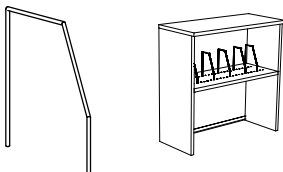

100-RD **\$99**

- COMPONENTS ARE NOT DRILLED FOR RECORD DIVIDERS UNLESS SPECIFIED AT THE TIME OF ORDER ON PO.

# 388/600 HUTCHES

## OPEN HUTCHES

| MODEL | 388  |      | 600    |                 |    |    | 388 |     | 600 |  |
|-------|------|------|--------|-----------------|----|----|-----|-----|-----|--|
|       | LIST | LIST | WEIGHT | CUBE            | W  | D  | H   | H   |     |  |
|       | 1"   | 1½"  | LBS    | FT <sup>3</sup> | IN | IN | 1"  | 1½" |     |  |

WHEN SIZING HUTCHES, OVERALL CAVITY CLEARANCE HEIGHT OF **600 SERIES** HUTCHES REDUCES BY 1" TO ACCOUNT FOR INCREASED THICKNESS OF **600 SERIES** WORKSURFACE TOP & INCREASED THICKNESS OF **600 SERIES** HUTCH TOP. TO ENSURE TOP ALIGNMENT, ORDER LIKE SERIES.

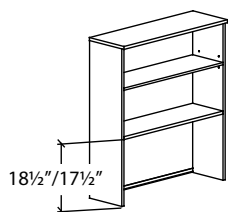

### DOUBLE HIGH OPEN HUTCHES - 48" HIGH

W/ 1 ADJUSTABLE SHELF

|           |         |         |     |     |       |    |       |       |
|-----------|---------|---------|-----|-----|-------|----|-------|-------|
| 388-4830H | \$888   | \$1,012 | 110 | 3.8 | 29.5  | 16 | 47.25 | 46.75 |
| 388-4836H | \$990   | \$1,129 | 114 | 3.8 | 35.5  | 16 | 47.25 | 46.75 |
| 388-4842H | \$1,059 | \$1,207 | 126 | 4.4 | 41.5  | 16 | 47.25 | 46.75 |
| 388-4848H | \$1,168 | \$1,332 | 139 | 4.4 | 47.25 | 16 | 47.25 | 46.75 |

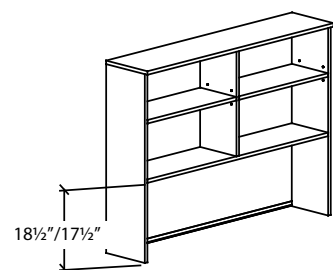

W/ DIVIDER & 2 ADJUSTABLE SHELVES.

|           |         |         |     |     |       |    |       |       |
|-----------|---------|---------|-----|-----|-------|----|-------|-------|
| 388-4854H | \$1,243 | \$1,417 | 154 | 5   | 53.25 | 16 | 47.25 | 46.75 |
| 388-4860H | \$1,379 | \$1,572 | 168 | 5   | 59.25 | 16 | 47.25 | 46.75 |
| 388-4866H | \$1,543 | \$1,759 | 192 | 5.6 | 65    | 16 | 47.25 | 46.75 |
| 388-4872H | \$1,640 | \$1,870 | 216 | 6.3 | 71    | 16 | 47.25 | 46.75 |

- ALL 36" HUTCH ACCESSORIES CAN BE USED W/ 48" HUTCHES
- ALL DOUBLE HIGH HUTCHES CAN BE ORDERED NO WIDER THAN 72".
- 48" HUTCHES ALIGN WITH 77" TALL STORAGE
- TO ORDER OPTIONAL VALANCE ADD -V TO SKU AND AN UP-CHARGE OF **\$218** TO THE PRICE  
**EXAMPLE:** 600-4872H-V

**RTA**

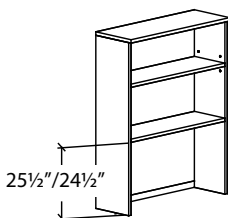

### DOUBLE HIGH OPEN HUTCH - 55" HIGH

1 ADJUSTABLE SHELF

|           |         |         |     |     |       |    |       |       |
|-----------|---------|---------|-----|-----|-------|----|-------|-------|
| 388-5530H | \$924   | \$979   | 115 | 3.8 | 29.5  | 16 | 54.25 | 53.75 |
| 388-5536H | \$1,040 | \$1,102 | 131 | 3.8 | 35.5  | 16 | 54.25 | 53.75 |
| 388-5542H | \$1,100 | \$1,166 | 147 | 4.4 | 41.5  | 16 | 54.25 | 53.75 |
| 388-5548H | \$1,218 | \$1,291 | 163 | 4.4 | 47.25 | 16 | 54.25 | 53.75 |

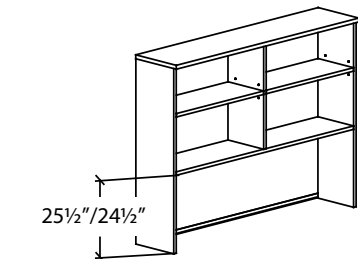

W/ DIVIDER & 2 ADJUSTABLE SHELVES

|           |         |         |     |     |       |    |       |       |
|-----------|---------|---------|-----|-----|-------|----|-------|-------|
| 388-5554H | \$1,463 | \$1,551 | 181 | 5   | 53.25 | 16 | 54.25 | 53.75 |
| 388-5560H | \$1,551 | \$1,644 | 197 | 5   | 59.25 | 16 | 54.25 | 53.75 |
| 388-5566H | \$1,648 | \$1,747 | 226 | 5.6 | 65    | 16 | 54.25 | 53.75 |
| 388-5572H | \$1,720 | \$1,823 | 253 | 6.3 | 71    | 16 | 54.25 | 53.75 |

- ALL DOUBLE HIGH HUTCHES CAN BE ORDERED NO WIDER THAN 72".
- 55" HUTCHES ALIGN WITH 84" TALL STORAGE
- TO ORDER OPTIONAL VALANCE ADD -V TO SKU AND AN UP-CHARGE OF **\$218** TO THE PRICE  
**EXAMPLE:** 600-5548H-V

**RTA**

| MODEL | 388  |      | 600       |      | AGD | WEIGHT | CUBE | W | D | 388 |    | 600 |    |
|-------|------|------|-----------|------|-----|--------|------|---|---|-----|----|-----|----|
|       | LIST | LIST | LIST      | LIST |     |        |      |   |   | H   | H  |     |    |
|       | 1"   | 1½"  | UP CHARGE | LBS  |     |        |      |   |   | FT³ | IN | IN  | 1" |

WHEN SIZING HUTCHES, OVERALL CAVITY CLEARANCE HEIGHT OF **600 SERIES** HUTCHES REDUCES BY 1" TO ACCOUNT FOR INCREASED THICKNESS OF **600 SERIES** WORKSURFACE TOP & INCREASED THICKNESS OF **600 SERIES** HUTCH TOP. TO ENSURE TOP ALIGNMENT, ORDER LIKE SERIES.

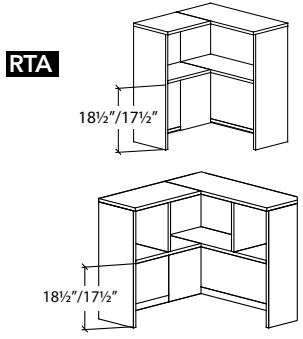

**CORNER HUTCH - 36" HIGH**

36" HUTCH

**388-3636CH**      **\$1,044**    **\$1,190**      N/A      102      5      35.5/  
35.5      16      35.5      35

42" HUTCH INCLUDES DIVIDERS

**388-4242CH**      **\$1,168**    **\$1,332**      N/A      118      5      41.5/  
41.5      16      35.5      35

**HINGED DOORS HUTCHES**

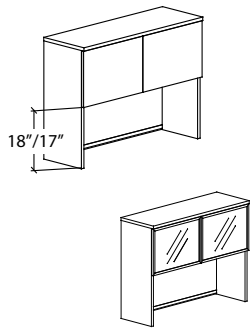

**HUTCH W/ HINGED DOORS - 36" HIGH**

DOORS SHIP IN A SECOND CARTON

**388-3630HHD**      **\$792**    **\$903**      \$420      79      3.5      29.5      16      35.5      35

**388-3636HHD**      **\$840**    **\$958**      \$466      84      3.5      35.5      16      35.5      35

**388-3642HHD**      **\$896**    **\$1,021**      \$513      94      4      41.5      16      35.5      35

**388-3648HHD**      **\$955**    **\$1,089**      \$532      105      4      47.25      16      35.5      35

W/ DIVIDER

**388-3654HHD**      **\$1,174**    **\$1,338**      \$814      116      4.5      53.25      16      35.5      35

**388-3660HHD**      **\$1,216**    **\$1,386**      \$834      128      4.5      59.25      16      35.5      35

**388-3666HHD**      **\$1,243**    **\$1,417**      \$886      145      5.5      65      16      35.5      35

**388-3672HHD**      **\$1,393**    **\$1,588**      \$893      163      6      71      16      35.5      35

**388-3678HHD**      **\$1,742**    **\$1,986**      \$1,019      180      7      77      16      35.5      35

**388-3684HHD**      **\$1,886**    **\$2,150**      \$1,044      198      7.5      82.75      16      35.5      35

- TO ORDER OPTIONAL VALANCE ADD -V TO SKU AND AN UP-CHARGE OF **\$218**  
**EXAMPLE:** 388-3648HHD-V

# 388/600 HUTCHES

## HINGED DOOR HUTCHES

| MODEL | 388  |      | 600       |      | AGD | WEIGHT | CUBE | W | D | 388             |    | 600 |    |
|-------|------|------|-----------|------|-----|--------|------|---|---|-----------------|----|-----|----|
|       | LIST | LIST | LIST      | LIST |     |        |      |   |   | H               | H  |     |    |
|       | 1"   | 1½"  | UP CHARGE | LBS  |     |        |      |   |   | FT <sup>3</sup> | IN | IN  | 1" |

WHEN SIZING HUTCHES, OVERALL CAVITY CLEARANCE HEIGHT OF **600 SERIES** HUTCHES REDUCES BY 1" TO ACCOUNT FOR INCREASED THICKNESS OF **600 SERIES** WORKSURFACE TOP & INCREASED THICKNESS OF **600 SERIES** HUTCH TOP. TO ENSURE TOP ALIGNMENT, ORDER LIKE SERIES.

### HUTCH W/ HINGED DOORS - 43" HIGH

DOORS SHIP IN A SECOND CARTON

|             |         |         |       |     |     |       |    |      |    |
|-------------|---------|---------|-------|-----|-----|-------|----|------|----|
| 388-4330HHD | \$851   | \$970   | \$420 | 91  | 4   | 29.5  | 16 | 42.5 | 42 |
| 388-4336HHD | \$905   | \$1,032 | \$466 | 96  | 4   | 35.5  | 16 | 42.5 | 42 |
| 388-4342HHD | \$974   | \$1,110 | \$513 | 107 | 4.5 | 41.5  | 16 | 42.5 | 42 |
| 388-4348HHD | \$1,038 | \$1,183 | \$532 | 120 | 4.5 | 47.25 | 16 | 42.5 | 42 |

W/ DIVIDER

|             |         |         |         |     |     |       |    |      |    |
|-------------|---------|---------|---------|-----|-----|-------|----|------|----|
| 388-4354HHD | \$1,293 | \$1,474 | \$814   | 133 | 5.3 | 53.25 | 16 | 42.5 | 42 |
| 388-4360HHD | \$1,361 | \$1,552 | \$834   | 146 | 5.8 | 59.25 | 16 | 42.5 | 42 |
| 388-4366HHD | \$1,390 | \$1,585 | \$886   | 166 | 6   | 65    | 16 | 42.5 | 42 |
| 388-4372HHD | \$1,526 | \$1,740 | \$893   | 186 | 7   | 71    | 16 | 42.5 | 42 |
| 388-4378HHD | \$1,817 | \$2,071 | \$1,019 | 200 | 8   | 77    | 16 | 42.5 | 42 |
| 388-4384HHD | \$1,918 | \$2,187 | \$1,044 | 218 | 8.5 | 82.75 | 16 | 42.5 | 42 |

#### \*\* OPTIONAL ALUMINUM GLAZED DOORS \*\*

- SELECT CLEAR (CL), FROSTED (FR) OR BRONZE (BR) PLEXIGLASS  
**EXAMPLE:** 388-4348HHD-AGD-CL
- TO LOCK HUTCH DOORS, ADD AN "L" TO ITEM # & ADD **\$76** TO RETAIL PRICE.  
**EXAMPLE:** 388-4348HHD-L
- HUTCH DOORS DO NOT REQUIRE HANDLES. TO ADD HANDLES PLEASE REFER TO PAGE [100-3](#).
- THE PRICE SHOWN FOR AGD DOORS IS AN UP-CHARGE THAT MUST BE ADDED TO THE BASE PRICE OF THE UNIT IT GOES ON.

RTA

### DOUBLE HIGH HUTCH W/ HINGED DOORS - 48" HIGH

W/ 1 ADJUSTABLE SHELF

|             |         |         |       |     |     |       |    |       |       |
|-------------|---------|---------|-------|-----|-----|-------|----|-------|-------|
| 388-4830HHD | \$1,246 | \$1,420 | \$591 | 127 | 4.3 | 29.5  | 16 | 47.25 | 46.75 |
| 388-4836HHD | \$1,347 | \$1,536 | \$676 | 136 | 4.3 | 35.5  | 16 | 47.25 | 46.75 |
| 388-4842HHD | \$1,417 | \$1,615 | \$742 | 151 | 4.9 | 41.5  | 16 | 47.25 | 46.75 |
| 388-4848HHD | \$1,526 | \$1,740 | \$809 | 168 | 5   | 47.25 | 16 | 47.25 | 46.75 |

W/ DIVIDER & 2 ADJUSTABLE SHELVES

|             |         |         |         |     |     |       |    |       |       |
|-------------|---------|---------|---------|-----|-----|-------|----|-------|-------|
| 388-4854HHD | \$1,878 | \$2,141 | \$1,110 | 188 | 5.7 | 53.25 | 16 | 47.25 | 46.75 |
| 388-4860HHD | \$2,014 | \$2,296 | \$1,176 | 206 | 5.8 | 59.25 | 16 | 47.25 | 46.75 |
| 388-4866HHD | \$2,177 | \$2,482 | \$1,268 | 233 | 6.4 | 65    | 16 | 47.25 | 46.75 |
| 388-4872HHD | \$2,276 | \$2,595 | \$1,293 | 261 | 7.2 | 71    | 16 | 47.25 | 46.75 |

- ALL 36" HUTCH ACCESSORIES CAN BE USED W/ 48" HUTCHES
- ALL DOUBLE HIGH HUTCHES CAN BE ORDERED NO WIDER THAN 72".
- DOORS SHIP IN A SECOND CARTON.
- TO ORDER OPTIONAL VALANCE ADD -V TO SKU AND AN UP-CHARGE OF **\$218**  
**EXAMPLE:** 388-4872HHD-V

RTA

| MODEL | 388  |      | 600       |      | AGD | WEIGHT | CUBE | W | D | 388 |    | 600 |    |
|-------|------|------|-----------|------|-----|--------|------|---|---|-----|----|-----|----|
|       | LIST | LIST | LIST      | LIST |     |        |      |   |   | H   | H  |     |    |
|       | 1"   | 1½"  | UP CHARGE | LBS  |     |        |      |   |   | FT³ | IN | IN  | 1" |

WHEN SIZING HUTCHES, OVERALL CAVITY CLEARANCE HEIGHT OF **600 SERIES** HUTCHES REDUCES BY 1" TO ACCOUNT FOR INCREASED THICKNESS OF **600 SERIES** WORKSURFACE TOP & INCREASED THICKNESS OF **600 SERIES** HUTCH TOP. TO ENSURE TOP ALIGNMENT, ORDER LIKE SERIES.

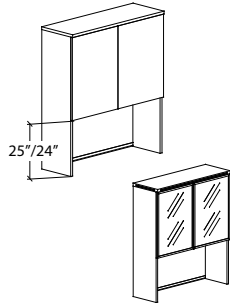

**DOUBLE HIGH HUTCH W/ HINGED DOORS - 55" HIGH**

1 ADJUSTABLE SHELF

|             |         |         |       |     |     |       |    |       |       |
|-------------|---------|---------|-------|-----|-----|-------|----|-------|-------|
| 388-5530HHD | \$1,282 | \$1,359 | \$623 | 135 | 4.2 | 29.5  | 16 | 54.25 | 53.75 |
| 388-5536HHD | \$1,388 | \$1,471 | \$710 | 156 | 4.3 | 35.5  | 16 | 54.25 | 53.75 |
| 388-5542HHD | \$1,449 | \$1,536 | \$776 | 177 | 5   | 41.5  | 16 | 54.25 | 53.75 |
| 388-5548HHD | \$1,549 | \$1,642 | \$840 | 198 | 5.1 | 47.25 | 16 | 54.25 | 53.75 |

HUTCH WITH AGD DOORS AND OPTIONAL VALANCE

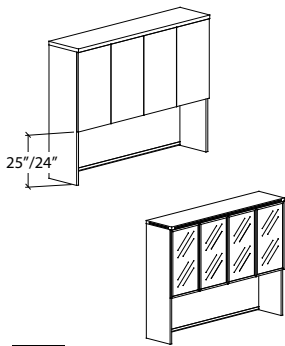

W/ DIVIDER & 2 ADJUSTABLE SHELVES

|             |         |         |         |     |     |       |    |       |       |
|-------------|---------|---------|---------|-----|-----|-------|----|-------|-------|
| 388-5554HHD | \$1,858 | \$1,969 | \$1,143 | 221 | 5.8 | 53.25 | 16 | 54.25 | 53.75 |
| 388-5560HHD | \$1,926 | \$2,042 | \$1,208 | 243 | 5.9 | 59.25 | 16 | 54.25 | 53.75 |
| 388-5566HHD | \$2,088 | \$2,213 | \$1,301 | 276 | 6.6 | 65    | 16 | 54.25 | 53.75 |
| 388-5572HHD | \$2,140 | \$2,440 | \$1,307 | 308 | 7.4 | 71    | 16 | 54.25 | 53.75 |

**\*\* OPTIONAL ALUMINUM GLAZED DOORS \*\***

- SELECT CLEAR (CL), FROSTED (FR) OR BRONZE (BR) PLEXIGLASS  
**EXAMPLE:** 600-5548HHD-AGD-**BR**
- TO LOCK HUTCH DOORS, **ADD AN "L" TO ITEM #** & ADD **\$76** TO RETAIL PRICE.  
**EXAMPLE:** 388-5548HHD-**L**
- HUTCH DOORS DO NOT REQUIRE HANDLES. TO ADD HANDLES TO DOORS, PLEASE REFER TO PAGE **100-3**
- THE PRICE SHOWN FOR AGD DOORS IS AN UP-CHARGE THAT MUST BE ADDED TO THE BASE PRICE OF THE UNIT IT GOES ON.
- DOORS SHIP IN A SECOND CARTON
- ALL DOUBLE HIGH HUTCHES CAN BE ORDERED NO WIDER THAN 72".
- TO ORDER OPTIONAL VALANCE ADD **-V** TO SKU AND AN UP-CHARGE OF **\$218**  
**EXAMPLE:** 600-5548HHD-**V**

**RTA**

**FLIPPER DOORS HUTCHES**

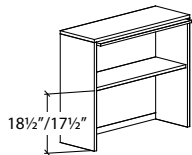

**HUTCH W/ FLIPPER DOORS - 36" HIGH**

|             |         |         |     |     |   |       |    |      |    |
|-------------|---------|---------|-----|-----|---|-------|----|------|----|
| 388-3630HFD | \$824   | \$939   | N/A | 74  | 4 | 29.5  | 16 | 35.5 | 35 |
| 388-3636HFD | \$873   | \$995   | N/A | 83  | 4 | 35.5  | 16 | 35.5 | 35 |
| 388-3642HFD | \$935   | \$1,066 | N/A | 92  | 4 | 41.5  | 16 | 35.5 | 35 |
| 388-3648HFD | \$1,001 | \$1,141 | N/A | 106 | 5 | 47.25 | 16 | 35.5 | 35 |

W/ DIVIDER

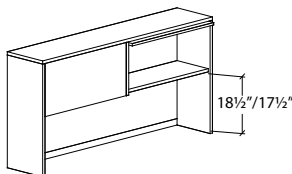

|             |         |         |     |     |     |       |    |      |    |
|-------------|---------|---------|-----|-----|-----|-------|----|------|----|
| 388-3654HFD | \$1,140 | \$1,300 | N/A | 140 | 5   | 53.25 | 16 | 35.5 | 35 |
| 388-3660HFD | \$1,244 | \$1,418 | N/A | 150 | 5   | 59.25 | 16 | 35.5 | 35 |
| 388-3666HFD | \$1,309 | \$1,492 | N/A | 160 | 6   | 65    | 16 | 35.5 | 35 |
| 388-3672HFD | \$1,448 | \$1,651 | N/A | 172 | 6   | 71    | 16 | 35.5 | 35 |
| 388-3678HFD | \$1,806 | \$2,059 | N/A | 185 | 6.5 | 77    | 16 | 35.5 | 35 |
| 388-3684HFD | \$1,912 | \$2,180 | N/A | 200 | 7   | 82.75 | 16 | 35.5 | 35 |

**RTA**

- TO ORDER OPTIONAL VALANCE ADD **-V** TO SKU AND AN UP-CHARGE OF **\$218**  
**EXAMPLE:** 600-5548HFD-**V**

# 388/600 HUTCHES + ACCESSORIES

## FLIPPER DOOR HUTCHES

| MODEL | 388  | 600  | WEIGHT | CUBE | W | D | 388 | 600 |
|-------|------|------|--------|------|---|---|-----|-----|
|       | LIST | LIST |        |      |   |   | H   | H   |
|       | 1"   | 1½"  |        |      |   |   | 1"  | 1½" |

WHEN SIZING HUTCHES, OVERALL CAVITY CLEARANCE HEIGHT OF **600 SERIES** HUTCHES REDUCES BY 1" TO ACCOUNT FOR INCREASED THICKNESS OF **600 SERIES** WORKSURFACE TOP & INCREASED THICKNESS OF **600 SERIES** HUTCH TOP. TO ENSURE TOP ALIGNMENT, ORDER LIKE SERIES.

### HUTCH W/ FLIPPER DOORS - 43" HIGH

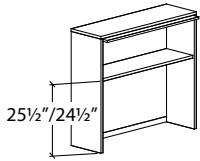

|             |         |         |     |     |       |    |      |    |
|-------------|---------|---------|-----|-----|-------|----|------|----|
| 388-4330HFD | \$957   | \$1,091 | 86  | 4   | 29.5  | 16 | 42.5 | 42 |
| 388-4336HFD | \$1,005 | \$1,146 | 93  | 4   | 35.5  | 16 | 42.5 | 42 |
| 388-4342HFD | \$1,067 | \$1,216 | 103 | 5   | 41.5  | 16 | 42.5 | 42 |
| 388-4348HFD | \$1,144 | \$1,304 | 115 | 5.6 | 47.25 | 16 | 42.5 | 42 |

### W/ DIVIDER

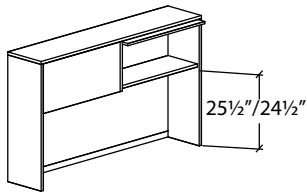

|             |         |         |     |     |       |    |      |    |
|-------------|---------|---------|-----|-----|-------|----|------|----|
| 388-4354HFD | \$1,307 | \$1,490 | 147 | 6   | 53.25 | 16 | 42.5 | 42 |
| 388-4360HFD | \$1,423 | \$1,622 | 179 | 6.6 | 59.25 | 16 | 42.5 | 42 |
| 388-4366HFD | \$1,500 | \$1,710 | 186 | 6.6 | 65    | 16 | 42.5 | 42 |
| 388-4372HFD | \$1,656 | \$1,888 | 193 | 7.5 | 71    | 16 | 42.5 | 42 |
| 388-4378HFD | \$2,089 | \$2,381 | 205 | 7.5 | 77    | 16 | 42.5 | 42 |
| 388-4384HFD | \$2,136 | \$2,435 | 220 | 8   | 82.75 | 16 | 42.5 | 42 |

- TO LOCK HUTCH DOORS, **ADD AN "L" TO ITEM #** & ADD **\$76** TO RETAIL PRICE.  
**EXAMPLE:** 388-4348HFD-L
- TO ORDER OPTIONAL VALANCE ADD **-V** TO SKU AND AN UP-CHARGE OF **\$218**  
**EXAMPLE:** 600-4372HFD-V

**RTA**

## TACKBOARDS

### TACK BOARDS - TO FIT 388 SERIES 36" & 48" HIGH HUTCHES

#### MOUNTING CLIPS INCLUDED

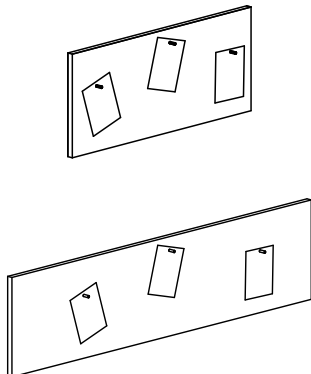

|            |       |       |    |     |       |   |       |       |
|------------|-------|-------|----|-----|-------|---|-------|-------|
| 388-3630TB | \$226 | \$226 | 10 | 1   | 26.5  | 1 | 14.75 | 14.75 |
| 388-3636TB | \$237 | \$237 | 11 | 1   | 32.5  | 1 | 14.75 | 14.75 |
| 388-3642TB | \$298 | \$298 | 12 | 1   | 38.5  | 1 | 14.75 | 14.75 |
| 388-3648TB | \$307 | \$307 | 12 | 1   | 44.75 | 1 | 14.75 | 14.75 |
| 388-3654TB | \$316 | \$316 | 13 | 2   | 50.25 | 1 | 14.75 | 14.75 |
| 388-3660TB | \$325 | \$325 | 15 | 2   | 56.25 | 1 | 14.75 | 14.75 |
| 388-3666TB | \$334 | \$334 | 16 | 2   | 62    | 1 | 14.75 | 14.75 |
| 388-3672TB | \$357 | \$357 | 17 | 2   | 68    | 1 | 14.75 | 14.75 |
| 388-3678TB | \$436 | \$436 | 18 | 2.5 | 74    | 1 | 14.75 | 14.75 |
| 388-3684TB | \$463 | \$463 | 19 | 2.5 | 79.75 | 1 | 14.75 | 14.75 |

| MODEL | 388  | 600  | WEIGHT | CUBE            | W  | D  | 388 | 600 |
|-------|------|------|--------|-----------------|----|----|-----|-----|
|       | LIST | LIST |        |                 |    |    | H   | H   |
|       | 1"   | 1½"  | LBS    | FT <sup>3</sup> | IN | IN | 1"  | 1½" |

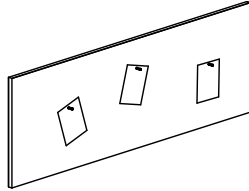
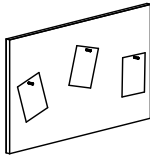

**TACK BOARD FOR 43" & 55" HIGH HUTCHES**

MOUNTING CLIPS INCLUDED.

|            |       |       |    |     |       |   |       |       |
|------------|-------|-------|----|-----|-------|---|-------|-------|
| 388-4330TB | \$279 | \$279 | 11 | 1   | 26.5  | 1 | 21.75 | 21.75 |
| 388-4336TB | \$290 | \$290 | 12 | 1   | 32.5  | 1 | 21.75 | 21.75 |
| 388-4342TB | \$342 | \$342 | 13 | 1   | 38.5  | 1 | 21.75 | 21.75 |
| 388-4348TB | \$353 | \$353 | 13 | 2   | 44.75 | 1 | 21.75 | 21.75 |
| 388-4354TB | \$360 | \$360 | 14 | 2   | 50.25 | 1 | 21.75 | 21.75 |
| 388-4360TB | \$370 | \$370 | 16 | 2   | 56.25 | 1 | 21.75 | 21.75 |
| 388-4366TB | \$381 | \$381 | 17 | 2   | 62    | 1 | 21.75 | 21.75 |
| 388-4372TB | \$387 | \$387 | 18 | 2   | 68    | 1 | 21.75 | 21.75 |
| 388-4378TB | \$463 | \$463 | 19 | 2.5 | 74    | 1 | 21.75 | 21.75 |
| 388-4384TB | \$516 | \$516 | 20 | 2.5 | 79.75 | 1 | 21.75 | 21.75 |

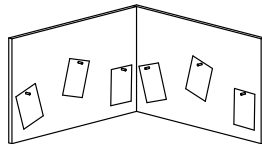

**TACK BOARDS -36" HIGH CORNER HUTCHES**

INCLUDES 2 TACK BOARDS. MOUNTING CLIPS INCLUDED.

|             |       |       |    |   |       |   |       |       |
|-------------|-------|-------|----|---|-------|---|-------|-------|
| 388-3636CTB | \$480 | \$480 | 22 | 2 | 31-31 | 1 | 14.75 | 14.75 |
| 388-4242CTB | \$511 | \$511 | 24 | 2 | 37-37 | 1 | 14.75 | 14.75 |

- 388/600 TACKBOARDS ARE SIZED FOR USE WITH 388/600 SERIES CORNER HUTCHES

**HUTCH ACCESSORIES**

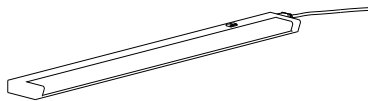

**TASK LIGHTS - FLUORESCENT**

24" TASK LIGHT

|          |       |     |     |     |       |     |      |     |
|----------|-------|-----|-----|-----|-------|-----|------|-----|
| 100-24TL | \$361 | N/A | 2.1 | 0.1 | 24.75 | 3.5 | 1.25 | N/A |
|----------|-------|-----|-----|-----|-------|-----|------|-----|

36" TASK LIGHT

|          |       |     |     |      |       |     |      |     |
|----------|-------|-----|-----|------|-------|-----|------|-----|
| 100-36TL | \$382 | N/A | 2.8 | 0.12 | 36.75 | 3.5 | 1.25 | N/A |
|----------|-------|-----|-----|------|-------|-----|------|-----|

48" TASK LIGHT

|          |       |     |   |      |       |     |      |     |
|----------|-------|-----|---|------|-------|-----|------|-----|
| 100-48TL | \$473 | N/A | 3 | 0.14 | 48.75 | 3.5 | 1.25 | N/A |
|----------|-------|-----|---|------|-------|-----|------|-----|

**WHEN ORDERING TASKLIGHTS, PLEASE KEEP IN MIND:**

- STANDARD HUTCHES DO NOT INCLUDE A GROMMET
- A CORD SWEEP IS INCLUDED ON THE BOTTOM OF THE HUTCH BACK
- TASKLIGHT INCLUDES A 9 FT. LONG CORD.
- DUE TO SLIMLINE DESIGN, TASKLIGHTS DO NOT REQUIRE A VALANCE.
- SWITCH AND CORD ARE ON THE RIGHT END

**AVAILABLE FINISH:** BLACK (BL)

# 388/600 HUTCHES + ACCESSORIES

## HUTCH ACCESSORIES

|       | 388  | 600  |        |                 |    |    | 388 | 600 |
|-------|------|------|--------|-----------------|----|----|-----|-----|
| MODEL | LIST | LIST | WEIGHT | CUBE            | W  | D  | H   | H   |
|       | 1"   | 1½"  | LBS    | FT <sup>3</sup> | IN | IN | 1"  | 1½" |

### LED TASK LIGHTS

|             |       |  |     |       |       |     |      |  |
|-------------|-------|--|-----|-------|-------|-----|------|--|
| 100-LED36TL | \$437 |  | 2.8 | 0.105 | 36.75 | 3.5 | 1.25 |  |
| 100-LED48TL | \$535 |  | 3   | 0.14  | 48.75 | 3.5 | 1.25 |  |

- BUILT-IN ON/OFF OCCUPANCY SENSOR
- 160° SWIVEL FEATURE TO POSITION THE LIGHT WHERE NEEDED
- MAX WATTS IS 180W IN LINE
- INCLUDES: 5' GROUNDED POWER CORD, MAGNET FOR METAL SHELF INSTALLATION AND SCREW KIT FOR WOOD SHELF MOUNTING
- CUL CERTIFIED

**AVAILABLE FINISH:** ALUMINIUM (AL)

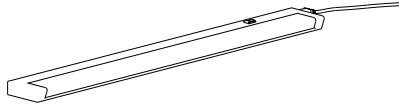

### RECORD DIVIDERS

OPTIONAL RECORD DIVIDERS AVAILABLE. SET OF 6

|        |      |  |  |  |  |  |  |  |
|--------|------|--|--|--|--|--|--|--|
| 100-RD | \$99 |  |  |  |  |  |  |  |
|--------|------|--|--|--|--|--|--|--|

- COMPONENTS ARE NOT DRILLED FOR RECORD DIVIDERS UNLESS SPECIFIED AT THE TIME OF ORDER ON PO.

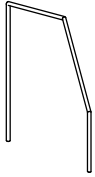

### VERTICAL CUBBY INSERT

OPTIONAL CUBBY INSERT, FITS 20" & 24" DEEP CABINETS

|             |       |       |    |      |       |    |       |     |
|-------------|-------|-------|----|------|-------|----|-------|-----|
| 388-1413VCI | \$257 | \$257 | 15 | .344 | 14.25 | 12 | 12.75 | N/A |
|-------------|-------|-------|----|------|-------|----|-------|-----|

**AVAILABLE FINISH:** BLACK (BL)

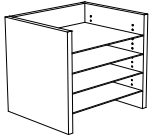

**RTA**

### VERTICAL CUBBY-HOLE - DESIGNED TO FIT IN HUTCHES

LETTER SIZE- FOR 36" & 48" HUTCHES - INCLUDES 5 ADJUSTABLE SHELVES

|            |       |       |    |   |    |    |      |      |
|------------|-------|-------|----|---|----|----|------|------|
| 388-1236VC | \$384 | \$384 | 25 | 1 | 12 | 11 | 18.5 | 18.5 |
|------------|-------|-------|----|---|----|----|------|------|

LEGAL SIZE- FOR 36" & 48" HUTCHES - INCLUDES 5 ADJUSTABLE SHELVES

|            |       |       |    |   |    |    |      |      |
|------------|-------|-------|----|---|----|----|------|------|
| 388-1836VC | \$446 | \$446 | 30 | 1 | 18 | 11 | 18.5 | 18.5 |
|------------|-------|-------|----|---|----|----|------|------|

LETTER SIZE- FOR 43" & 55" HUTCHES - INCLUDES 7 ADJUSTABLE SHELVES

|            |       |       |    |   |    |    |      |      |
|------------|-------|-------|----|---|----|----|------|------|
| 388-1243VC | \$416 | \$416 | 32 | 2 | 12 | 11 | 25.5 | 25.5 |
|------------|-------|-------|----|---|----|----|------|------|

LEGAL SIZE- FOR 43" & 55" HUTCHES - INCLUDES 7 ADJUSTABLE SHELVES

|            |       |       |    |   |    |    |      |      |
|------------|-------|-------|----|---|----|----|------|------|
| 388-1843VC | \$480 | \$480 | 38 | 2 | 18 | 11 | 25.5 | 25.5 |
|------------|-------|-------|----|---|----|----|------|------|

- 388 VERTICAL CUBBY HOLE STORAGE IS SIZED FOR USE WITH 388/600 SERIES.
- NO BACK FOR ACCESS ON BOTH SIDES.

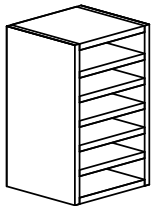

**RTA**

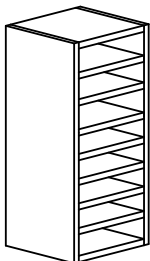



| MODEL | 388  | 600  | WEIGHT | CUBE | W | D | 388 | 600 |
|-------|------|------|--------|------|---|---|-----|-----|
|       | LIST | LIST |        |      |   |   | H   | H   |
|       | 1"   | 1½"  |        |      |   |   | 1"  | 1½" |

**HORIZONTAL CUBBY-HOLE**

W/ ADJUSTABLE DIVIDERS - GREAT FOR ORGANIZING PAPER, ENVELOPES, ETC.

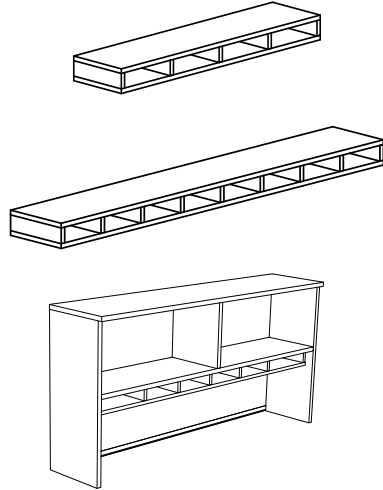

388-3672H WITH 388-7204HC

|            |       |       |    |     |       |    |   |   |
|------------|-------|-------|----|-----|-------|----|---|---|
| 388-3004HC | \$303 | \$303 | 11 | 1   | 27.5  | 11 | 4 | 4 |
| 388-3604HC | \$312 | \$312 | 14 | 1   | 33.5  | 11 | 4 | 4 |
| 388-4204HC | \$361 | \$361 | 17 | 1   | 39.5  | 11 | 4 | 4 |
| 388-4804HC | \$368 | \$368 | 20 | 2   | 45.75 | 11 | 4 | 4 |
| 388-5404HC | \$378 | \$378 | 23 | 2   | 51.25 | 11 | 4 | 4 |
| 388-6004HC | \$405 | \$405 | 26 | 2   | 57.25 | 11 | 4 | 4 |
| 388-6604HC | \$435 | \$435 | 29 | 2   | 63    | 11 | 4 | 4 |
| 388-7204HC | \$463 | \$463 | 32 | 2   | 69    | 11 | 4 | 4 |
| 388-7804HC | \$479 | \$479 | 35 | 2.5 | 75    | 11 | 4 | 4 |
| 388-8404HC | \$493 | \$493 | 38 | 2.5 | 80.75 | 11 | 4 | 4 |

• HORIZONTAL CUBBY-HOLE STORAGE **WILL NOT WORK WITH OPTIONAL VALENCE.**

**388/600 DESKTOP STORAGE ORGANIZERS**

**DESKTOP ORGANIZER - 12" DEEP UNIT**

FOR LETTER STORAGE. STAND ALONE UNIT W/ BACK.

1 DIVIDER, 6 ADJUSTABLE SHELVES

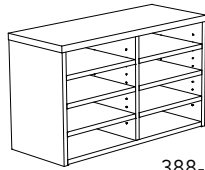

388-1830DTO

|             |       |       |    |   |       |    |       |       |
|-------------|-------|-------|----|---|-------|----|-------|-------|
| 388-1824DTO | \$585 | \$649 | 46 | 2 | 23.75 | 12 | 17.75 | 17.25 |
| 388-1830DTO | \$593 | \$658 | 49 | 2 | 29.5  | 12 | 17.75 | 17.25 |

2 DIVIDERS, 9 ADJUSTABLE SHELVES

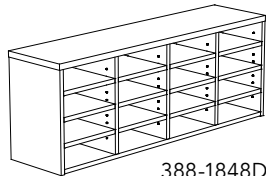

388-1848DTO

|             |       |       |    |     |      |    |       |       |
|-------------|-------|-------|----|-----|------|----|-------|-------|
| 388-1836DTO | \$603 | \$669 | 52 | 2   | 35.5 | 12 | 17.75 | 17.25 |
| 388-1842DTO | \$650 | \$722 | 56 | 2.3 | 41.5 | 12 | 17.75 | 17.25 |

3 DIVIDERS, 12 ADJUSTABLE SHELVES

|             |       |       |    |     |       |    |       |       |
|-------------|-------|-------|----|-----|-------|----|-------|-------|
| 388-1848DTO | \$664 | \$737 | 62 | 2.7 | 47.25 | 12 | 17.75 | 17.25 |
|-------------|-------|-------|----|-----|-------|----|-------|-------|

• WILL FIT IN 36" HIGH HUTCH CAVITY

1 DIVIDER, 8 ADJUSTABLE SHELVES

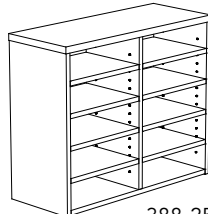

388-2530DTO

|             |       |       |    |   |       |    |       |       |
|-------------|-------|-------|----|---|-------|----|-------|-------|
| 388-2524DTO | \$593 | \$658 | 69 | 2 | 23.75 | 12 | 24.75 | 24.25 |
| 388-2530DTO | \$602 | \$668 | 72 | 2 | 29.5  | 12 | 24.75 | 24.25 |

2 DIVIDERS, 12 ADJUSTABLE SHELVES

|             |       |       |    |     |      |    |       |       |
|-------------|-------|-------|----|-----|------|----|-------|-------|
| 388-2536DTO | \$620 | \$688 | 76 | 2   | 35.5 | 12 | 24.75 | 24.25 |
| 388-2542DTO | \$700 | \$777 | 82 | 2.3 | 41.5 | 12 | 24.75 | 24.25 |

3 DIVIDERS, 16 ADJUSTABLE SHELVES

|             |       |       |    |     |       |    |       |       |
|-------------|-------|-------|----|-----|-------|----|-------|-------|
| 388-2548DTO | \$716 | \$795 | 89 | 2.7 | 47.25 | 12 | 24.75 | 24.25 |
|-------------|-------|-------|----|-----|-------|----|-------|-------|

• WILL FIT IN 43" HIGH HUTCH CAVITY

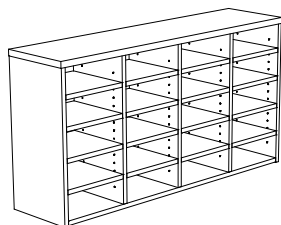

388-2548DTO

**RTA**

# 388/600 DESKTOP STORAGE MAIL SORTS

|       | 388  | 600  |        |                 |    |    | 388 | 600 |
|-------|------|------|--------|-----------------|----|----|-----|-----|
| MODEL | LIST | LIST | WEIGHT | CUBE            | W  | D  | H   | H   |
|       | 1"   | 1½"  | LBS    | FT <sup>3</sup> | IN | IN | 1"  | 1½" |

### DESKTOP MAIL SORT - 16" DEEP UNIT

DESIGNED TO MATCH DEPTH OF OTHER DESKTOP STORAGE UNITS (HUTCHES, DESKTOP STORAGE, OVERHEAD STORAGE & DESKTOP CABINETS).

2 DIVIDER, 9 ADJUSTABLE SHELVES

|            |       |       |    |     |      |    |       |       |
|------------|-------|-------|----|-----|------|----|-------|-------|
| 388-1836MS | \$598 | \$664 | 46 | 2   | 35.5 | 16 | 17.75 | 17.25 |
| 388-1842MS | \$665 | \$738 | 54 | 2.3 | 41.5 | 16 | 17.75 | 17.25 |

3 DIVIDERS, 12 ADJUSTABLE SHELVES

|            |       |       |    |     |       |    |       |       |
|------------|-------|-------|----|-----|-------|----|-------|-------|
| 388-1848MS | \$725 | \$805 | 66 | 2.7 | 47.25 | 16 | 17.75 | 17.25 |
|------------|-------|-------|----|-----|-------|----|-------|-------|

5 DIVIDERS, 18 ADJUSTABLE SHELVES

|            |       |         |    |     |    |    |       |       |
|------------|-------|---------|----|-----|----|----|-------|-------|
| 388-1872MS | \$962 | \$1,068 | 86 | 3.7 | 71 | 16 | 17.75 | 17.25 |
|------------|-------|---------|----|-----|----|----|-------|-------|

2 DIVIDER, 21 ADJUSTABLE SHELVES

|            |       |         |     |   |      |    |      |    |
|------------|-------|---------|-----|---|------|----|------|----|
| 388-3636MS | \$949 | \$1,053 | 90  | 3 | 35.5 | 16 | 35.5 | 35 |
| 388-3642MS | \$990 | \$1,099 | 106 | 3 | 41.5 | 16 | 35.5 | 35 |

3 DIVIDERS, 28 ADJUSTABLE SHELVES

|            |         |         |     |     |       |    |      |    |
|------------|---------|---------|-----|-----|-------|----|------|----|
| 388-3648MS | \$1,084 | \$1,203 | 130 | 3.5 | 47.25 | 16 | 35.5 | 35 |
|------------|---------|---------|-----|-----|-------|----|------|----|

5 DIVIDERS, 42 ADJUSTABLE SHELVES

|            |         |         |     |   |    |    |      |    |
|------------|---------|---------|-----|---|----|----|------|----|
| 388-3672MS | \$1,466 | \$1,627 | 151 | 4 | 71 | 16 | 35.5 | 35 |
|------------|---------|---------|-----|---|----|----|------|----|

2 DIVIDER, 27 ADJUSTABLE SHELVES

|            |         |         |     |     |      |    |      |    |
|------------|---------|---------|-----|-----|------|----|------|----|
| 388-4336MS | \$1,032 | \$1,146 | 111 | 3   | 35.5 | 16 | 42.5 | 42 |
| 388-4342MS | \$1,162 | \$1,290 | 131 | 3.3 | 41.5 | 16 | 42.5 | 42 |

3 DIVIDERS, 36 ADJUSTABLE SHELVES

|            |         |         |     |   |       |    |      |    |
|------------|---------|---------|-----|---|-------|----|------|----|
| 388-4348MS | \$1,278 | \$1,419 | 149 | 4 | 47.25 | 16 | 42.5 | 42 |
|------------|---------|---------|-----|---|-------|----|------|----|

5 DIVIDERS, 54 ADJUSTABLE SHELVES

|            |         |         |     |   |    |    |      |    |
|------------|---------|---------|-----|---|----|----|------|----|
| 388-4372MS | \$1,801 | \$1,999 | 194 | 6 | 71 | 16 | 42.5 | 42 |
|------------|---------|---------|-----|---|----|----|------|----|

2 DIVIDER, 30 ADJUSTABLE SHELVES

|            |         |         |     |     |      |    |       |       |
|------------|---------|---------|-----|-----|------|----|-------|-------|
| 388-4836MS | \$1,215 | \$1,349 | 143 | 3.5 | 35.5 | 16 | 47.25 | 46.75 |
| 388-4842MS | \$1,370 | \$1,521 | 168 | 4   | 41.5 | 16 | 47.25 | 46.75 |

3 DIVIDERS, 40 ADJUSTABLE SHELVES

|            |         |         |     |     |       |    |       |       |
|------------|---------|---------|-----|-----|-------|----|-------|-------|
| 388-4848MS | \$1,508 | \$1,674 | 192 | 4.5 | 47.25 | 16 | 47.25 | 46.75 |
|------------|---------|---------|-----|-----|-------|----|-------|-------|

5 DIVIDERS, 60 ADJUSTABLE SHELVES

|            |         |         |     |     |    |    |       |       |
|------------|---------|---------|-----|-----|----|----|-------|-------|
| 388-4872MS | \$2,170 | \$2,409 | 250 | 6.5 | 71 | 16 | 47.25 | 46.75 |
|------------|---------|---------|-----|-----|----|----|-------|-------|

- WALL HUNG & FLOOR MODELS ALSO AVAILABLE. CONTACT CUSTOMER SERVICE FOR MORE INFORMATION. SOME SIZE RESTRICTIONS APPLY.

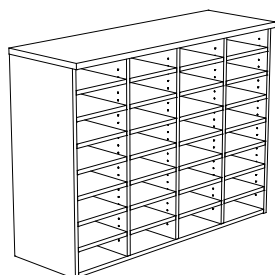

388-3648MS

RTA

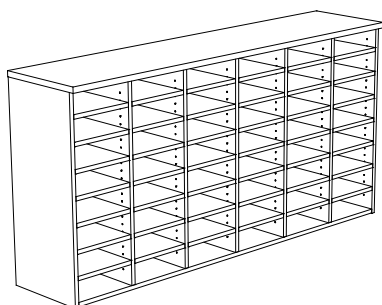

388-3672MS

RTA

### DESK TOP STORAGE EXAMPLES:

**EXAMPLE 1:**  
388-C2472C  
388-3636MS  
388-3636DTC

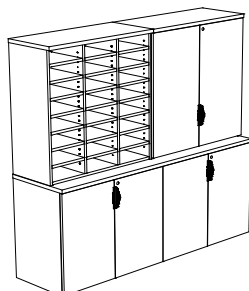

**EXAMPLE 2:**  
388-C2472C  
388-1818DTC-L  
388-1818DTC-R  
388-1836DTC  
388-4724OUFWR-24

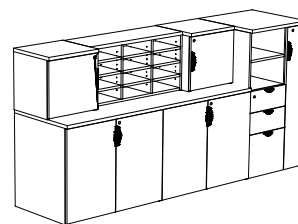

| MODEL | 388  | 600  | WEIGHT | CUBE | W | D | 388 | 600 |
|-------|------|------|--------|------|---|---|-----|-----|
|       | LIST | LIST |        |      |   |   | H   | H   |
|       | 1"   | 1½"  |        |      |   |   | 1"  | 1½" |

**DESKTOP OPEN STORAGE**

MATCHES 47" CABINETS HEIGHT. 1 ADJUSTABLE SHELF.



388-1818DTS

|             |       |       |    |     |       |    |       |       |
|-------------|-------|-------|----|-----|-------|----|-------|-------|
| 388-1818DTS | \$475 | \$542 | 36 | 3.2 | 17.75 | 16 | 17.75 | 17.25 |
| 388-1824DTS | \$513 | \$585 | 50 | 3.2 | 23.75 | 16 | 17.75 | 17.25 |
| 388-1830DTS | \$538 | \$613 | 52 | 4   | 29.5  | 16 | 17.75 | 17.25 |
| 388-1836DTS | \$638 | \$727 | 58 | 4.2 | 35.5  | 16 | 17.75 | 17.25 |

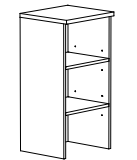

388-3618DTS

MATCHES 36" HUTCH OR 65" CABINET HEIGHTS. 2 ADJUSTABLE SHELVES.

|             |       |       |    |     |       |    |      |    |
|-------------|-------|-------|----|-----|-------|----|------|----|
| 388-3618DTS | \$490 | \$559 | 61 | 4   | 17.75 | 16 | 35.5 | 35 |
| 388-3624DTS | \$525 | \$599 | 66 | 4.5 | 23.75 | 16 | 35.5 | 35 |
| 388-3630DTS | \$585 | \$667 | 71 | 4.5 | 29.5  | 16 | 35.5 | 35 |
| 388-3636DTS | \$690 | \$787 | 73 | 4.5 | 35.5  | 16 | 35.5 | 35 |

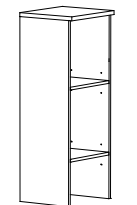

388-4318DTS

MATCHES 43" HUTCH OR 72" CABINET HEIGHTS. 2 ADJUSTABLE SHELVES.

|             |       |       |    |     |       |    |      |    |
|-------------|-------|-------|----|-----|-------|----|------|----|
| 388-4318DTS | \$509 | \$580 | 74 | 3   | 17.75 | 16 | 42.5 | 42 |
| 388-4324DTS | \$537 | \$612 | 79 | 3.5 | 23.75 | 16 | 42.5 | 42 |
| 388-4330DTS | \$638 | \$727 | 84 | 4   | 29.5  | 16 | 42.5 | 42 |
| 388-4336DTS | \$705 | \$804 | 90 | 4   | 35.5  | 16 | 42.5 | 42 |

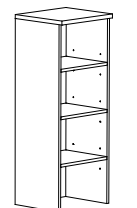

388-4818DTS

MATCHES DOUBLE HIGH 48" HUTCH OR 77" HIGH CABINET HEIGHTS. 3 ADJUSTABLE SHELVES.

|             |       |       |     |     |       |    |       |       |
|-------------|-------|-------|-----|-----|-------|----|-------|-------|
| 388-4818DTS | \$572 | \$652 | 86  | 4.5 | 17.75 | 16 | 47.25 | 46.75 |
| 388-4824DTS | \$601 | \$685 | 92  | 4.5 | 23.75 | 16 | 47.25 | 46.75 |
| 388-4830DTS | \$647 | \$738 | 100 | 4.7 | 29.5  | 16 | 47.25 | 46.75 |
| 388-4836DTS | \$787 | \$897 | 107 | 4.9 | 35.5  | 16 | 47.25 | 46.75 |

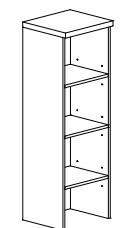

388-5518DTS

MATCHES DOUBLE HIGH 55" HUTCH OR 84" CABINET HEIGHT. 3 ADJUSTABLE SHELVES.

|             |       |       |     |     |       |    |       |       |
|-------------|-------|-------|-----|-----|-------|----|-------|-------|
| 388-5518DTS | \$605 | \$690 | 98  | 5   | 17.75 | 16 | 54.25 | 53.75 |
| 388-5524DTS | \$638 | \$727 | 107 | 5   | 23.75 | 16 | 54.25 | 53.75 |
| 388-5530DTS | \$758 | \$864 | 117 | 5.5 | 29.5  | 16 | 54.25 | 53.75 |
| 388-5536DTS | \$838 | \$955 | 132 | 5.5 | 35.5  | 16 | 54.25 | 53.75 |

**RTA**

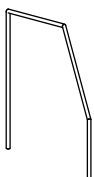

**RECORD DIVIDERS**

OPTIONAL RECORD DIVIDERS AVAILABLE. SET OF 6

100-RD **\$99**

- COMPONENTS ARE NOT DRILLED FOR RECORD DIVIDERS UNLESS SPECIFIED AT THE TIME OF ORDER ON PO.

# 388/600 DESK TOP STORAGE STORAGE W/ HINGED DOORS

|       | 388  | 600  |           |        |                 |    |    |    | 388 | 600 |
|-------|------|------|-----------|--------|-----------------|----|----|----|-----|-----|
| MODEL | LIST | LIST | AGD       | WEIGHT | CUBE            | W  | D  | H  | H   |     |
|       | 1"   | 1½"  | UP CHARGE | LBS    | FT <sup>3</sup> | IN | IN | 1" | 1½" |     |

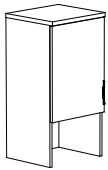

388-3618DTSHD-L

## DESKTOP STORAGE W/ HINGED DOORS

MATCHES 36" HUTCH OR 65" CABINET HEIGHTS. 1 ADJUSTABLE SHELF.  
SINGLE DOOR - HINGED LEFT

|                 |       |       |       |    |     |       |    |      |    |
|-----------------|-------|-------|-------|----|-----|-------|----|------|----|
| 388-3618DTSHD-L | \$601 | \$685 | \$418 | 63 | 7.5 | 17.75 | 16 | 35.5 | 35 |
| 388-3624DTSHD-L | \$656 | \$748 | \$452 | 81 | 10  | 23.75 | 16 | 35.5 | 35 |

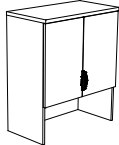

388-3630DTSHD

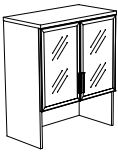

388-3630DTSHD-AGD

SINGLE DOOR - HINGED RIGHT

|                 |       |       |       |    |     |       |    |      |    |
|-----------------|-------|-------|-------|----|-----|-------|----|------|----|
| 388-3618DTSHD-R | \$601 | \$685 | \$418 | 63 | 7.5 | 17.75 | 16 | 35.5 | 35 |
| 388-3624DTSHD-R | \$656 | \$748 | \$452 | 81 | 10  | 23.75 | 16 | 35.5 | 35 |

DOUBLE DOOR

|               |       |       |       |    |    |      |    |      |    |
|---------------|-------|-------|-------|----|----|------|----|------|----|
| 388-3630DTSHD | \$757 | \$863 | \$589 | 92 | 12 | 29.5 | 16 | 35.5 | 35 |
| 388-3636DTSHD | \$872 | \$994 | \$622 | 97 | 14 | 35.5 | 16 | 35.5 | 35 |

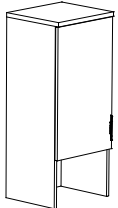

388-4318DTSHD-L

MATCHES 43" HUTCH OR 72" CABINET HEIGHTS. 1 ADJUSTABLE SHELF.  
SINGLE DOOR - HINGED LEFT

|                 |       |       |       |    |      |       |    |      |    |
|-----------------|-------|-------|-------|----|------|-------|----|------|----|
| 388-4318DTSHD-L | \$671 | \$765 | \$435 | 69 | 8.75 | 17.75 | 16 | 42.5 | 42 |
| 388-4324DTSHD-L | \$705 | \$804 | \$457 | 88 | 12   | 23.75 | 16 | 42.5 | 42 |

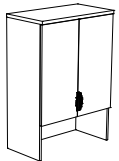

388-4330DTSHD

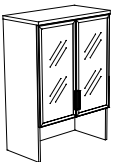

388-4330DTSHD-AGD

SINGLE DOOR - HINGED RIGHT

|                 |       |       |       |    |      |       |    |      |    |
|-----------------|-------|-------|-------|----|------|-------|----|------|----|
| 388-4318DTSHD-R | \$671 | \$765 | \$435 | 69 | 8.75 | 17.75 | 16 | 42.5 | 42 |
| 388-4324DTSHD-R | \$705 | \$804 | \$457 | 88 | 12   | 23.75 | 16 | 42.5 | 42 |

DOUBLE DOOR

|               |       |         |       |     |    |      |    |      |    |
|---------------|-------|---------|-------|-----|----|------|----|------|----|
| 388-4330DTSHD | \$851 | \$970   | \$619 | 94  | 14 | 29.5 | 16 | 42.5 | 42 |
| 388-4336DTSHD | \$976 | \$1,113 | \$629 | 107 | 17 | 35.5 | 16 | 42.5 | 42 |

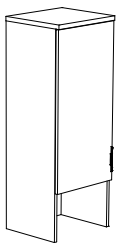

388-4818DTSHD-L

MATCHES DOUBLE HIGH 48" HUTCH OR 77" HIGH CABINET HEIGHTS. 2 ADJUSTABLE SHELVES.  
SINGLE DOOR - HINGED LEFT

|                 |       |       |       |     |      |       |    |       |       |
|-----------------|-------|-------|-------|-----|------|-------|----|-------|-------|
| 388-4818DTSHD-L | \$732 | \$834 | \$488 | 89  | 9.75 | 17.75 | 16 | 47.25 | 46.75 |
| 388-4824DTSHD-L | \$769 | \$877 | \$513 | 107 | 14   | 23.75 | 16 | 47.25 | 46.75 |

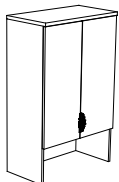

388-4830DTSHD

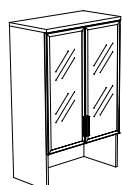

388-4830DTSHD-AGD

SINGLE DOOR - HINGED RIGHT

|                 |       |       |       |     |      |       |    |       |       |
|-----------------|-------|-------|-------|-----|------|-------|----|-------|-------|
| 388-4818DTSHD-R | \$732 | \$834 | \$488 | 89  | 9.75 | 17.75 | 16 | 47.25 | 46.75 |
| 388-4824DTSHD-R | \$769 | \$877 | \$513 | 107 | 14   | 23.75 | 16 | 47.25 | 46.75 |

DOUBLE DOOR

|               |         |         |       |     |    |      |    |       |       |
|---------------|---------|---------|-------|-----|----|------|----|-------|-------|
| 388-4830DTSHD | \$914   | \$1,042 | \$678 | 124 | 17 | 29.5 | 16 | 47.25 | 46.75 |
| 388-4836DTSHD | \$1,039 | \$1,184 | \$753 | 140 | 20 | 35.5 | 16 | 47.25 | 46.75 |

• TO LOCK DESK TOP STORAGE DOORS, **ADD AN "L" TO ITEM #** & ADD **\$76** TO RETAIL PRICE.  
**EXAMPLE:** 388-3630DTSHD-L.

| MODEL | 388  |      | 600       |  | AGD | WEIGHT<br>LBS | CUBE<br>FT <sup>3</sup> | W<br>IN | D<br>IN | 388 |     | 600 |  |
|-------|------|------|-----------|--|-----|---------------|-------------------------|---------|---------|-----|-----|-----|--|
|       | LIST | LIST | UP CHARGE |  |     |               |                         |         |         | H   | H   |     |  |
|       | 1"   | 1½"  |           |  |     |               |                         |         |         | 1"  | 1½" |     |  |

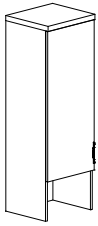

388-5518DTSHD-L

MATCHES DOUBLE HIGH 55" HUTCH OR 84" CABINET HEIGHT. 2 ADJUSTABLE SHELVES.  
SINGLE DOOR - HINGED LEFT

|                 |       |         |       |     |    |       |    |       |       |
|-----------------|-------|---------|-------|-----|----|-------|----|-------|-------|
| 388-5518DTSHD-L | \$792 | \$903   | \$501 | 120 | 14 | 17.75 | 16 | 54.25 | 53.75 |
| 388-5524DTSHD-L | \$906 | \$1,033 | \$544 | 141 | 21 | 23.75 | 16 | 54.25 | 53.75 |

SINGLE DOOR - HINGED RIGHT

|                 |       |         |       |     |    |       |    |       |       |
|-----------------|-------|---------|-------|-----|----|-------|----|-------|-------|
| 388-5518DTSHD-R | \$792 | \$903   | \$501 | 120 | 14 | 17.75 | 16 | 54.25 | 53.75 |
| 388-5524DTSHD-R | \$906 | \$1,033 | \$544 | 141 | 21 | 23.75 | 16 | 54.25 | 53.75 |

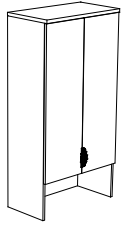

388-5530DTSHD



388-5530DTSHD-AGD-FR\*

DOUBLE DOOR

|               |         |         |       |     |    |      |    |       |       |
|---------------|---------|---------|-------|-----|----|------|----|-------|-------|
| 388-5530DTSHD | \$1,093 | \$1,246 | \$710 | 155 | 23 | 29.5 | 16 | 54.25 | 53.75 |
| 388-5536DTSHD | \$1,196 | \$1,363 | \$765 | 165 | 26 | 35.5 | 16 | 54.25 | 53.75 |

**\*\* OPTIONAL ALUMINUM GLAZED DOORS \*\***

- SELECT CLEAR (CL), FROSTED (FR) OR BRONZE (BR) PLEXIGLASS

**EXAMPLE:** 388-3618DTSHD-L-AGD-FR

- AGD DOORS INCLUDE SILVER FINISH BAR HANDLES. PLEASE REFER TO PAGE 100-3 FOR OTHER HANDLE SELECTIONS.

THE PRICE SHOWN FOR AGD DOORS IS AN UP-CHARGE THAT MUST BE ADDED TO THE BASE PRICE OF THE UNIT IT GOES ON.

**EXAMPLE 1:**

388-UFL2060C  
388-3618DTSHD-L  
388-3618DTSHD-R  
388-3624DTS - SHOWS  
OPTIONAL RECORD  
DIVIDERS

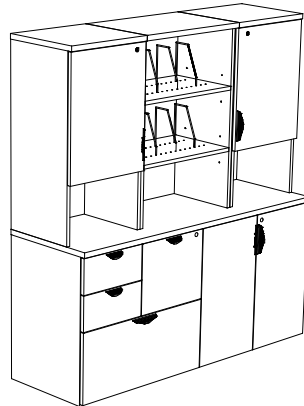

**EXAMPLE 2:**

388-C2078C  
388-3618DTSHD-L  
388-3618DTSHD-R  
388-3642MS

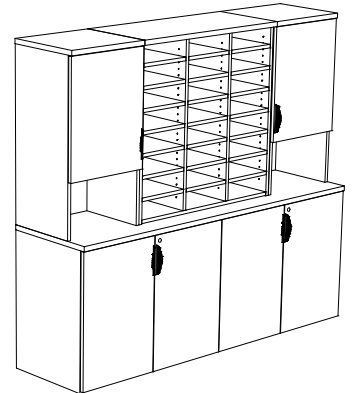

# 388/600 DESKTOP STORAGE CABINET W/ HINGED DOORS

| MODEL | 388  |      | 600       |           | AGD | WEIGHT<br>LBS | CUBE<br>FT <sup>3</sup> | W<br>IN | D<br>IN | 388 |     | 600 |  |
|-------|------|------|-----------|-----------|-----|---------------|-------------------------|---------|---------|-----|-----|-----|--|
|       | LIST | LIST | UP CHARGE | UP CHARGE |     |               |                         |         |         | H   | H   |     |  |
|       | 1"   | 1½"  |           |           |     |               |                         |         |         | 1"  | 1½" |     |  |

## DESKTOP CABINET

MATCHES 47" CABINET HEIGHT  
SINGLE DOOR - HINGED LEFT

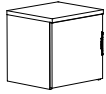

388-1818DTC-L

**388-1818DTC-L**    **\$493**    **\$562**    *\$270*    **68**    **4**    **17.75**    **16**    **17.75**    **17.25**

**388-1824DTC-L**    **\$537**    **\$612**    *\$281*    **86**    **5**    **23.75**    **16**    **17.75**    **17.25**

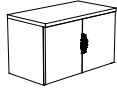

388-1830DTC

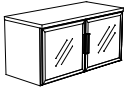

388-1830DTC-AGD-FR

SINGLE DOOR - HINGED RIGHT

**388-1818DTC-R**    **\$493**    **\$562**    *\$270*    **68**    **4**    **17.75**    **16**    **17.75**    **17.25**

**388-1824DTC-R**    **\$537**    **\$612**    *\$281*    **86**    **5**    **23.75**    **16**    **17.75**    **17.25**

DOUBLE DOOR

**388-1830DTC**    **\$606**    **\$691**    *\$513*    **91**    **6**    **29.5**    **16**    **17.75**    **17.25**

**388-1836DTC**    **\$675**    **\$770**    *\$562*    **102**    **7**    **35.5**    **16**    **17.75**    **17.25**



388-3618DTC-L

MATCHES 36" HUTCH OR 65" CABINET HEIGHTS. 2 ADJUSTABLE SHELVES.  
SINGLE DOOR - HINGED LEFT

**388-3618DTC-L**    **\$607**    **\$692**    *\$418*    **74**    **7.5**    **17.75**    **16**    **35.5**    **35**

**388-3624DTC-L**    **\$663**    **\$756**    *\$452*    **93**    **10**    **23.75**    **16**    **35.5**    **35**

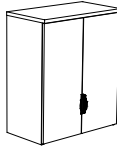

388-3630DTC

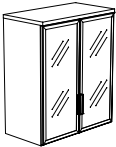

388-3630DTC-AGD-FR

SINGLE DOOR - HINGED RIGHT

**388-3618DTC-R**    **\$607**    **\$692**    *\$418*    **74**    **7.5**    **17.75**    **16**    **35.5**    **35**

**388-3624DTC-R**    **\$663**    **\$756**    *\$452*    **93**    **10**    **23.75**    **16**    **35.5**    **35**

DOUBLE DOOR

**388-3630DTC**    **\$757**    **\$863**    *\$589*    **99**    **12**    **29.5**    **16**    **35.5**    **35**

**388-3636DTC**    **\$872**    **\$994**    *\$622*    **112**    **14**    **35.5**    **16**    **35.5**    **35**

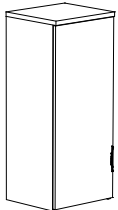

388-4318DTC-L

MATCHES 43" HUTCH OR 72" CABINET HEIGHTS. 2 ADJUSTABLE SHELVES.  
SINGLE DOOR - HINGED LEFT

**388-4318DTC-L**    **\$671**    **\$765**    *\$435*    **84**    **8.75**    **17.75**    **16**    **42.5**    **42**

**388-4324DTC-L**    **\$710**    **\$809**    *\$457*    **103**    **12**    **23.75**    **16**    **42.5**    **42**

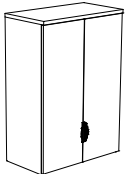

388-4330DTC

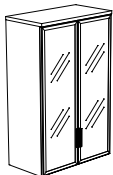

388-4330DTC-AGD-FR

SINGLE DOOR - HINGED RIGHT

**388-4318DTC-R**    **\$671**    **\$765**    *\$435*    **84**    **8.75**    **17.75**    **16**    **42.5**    **42**

**388-4324DTC-R**    **\$710**    **\$809**    *\$457*    **103**    **12**    **23.75**    **16**    **42.5**    **42**

DOUBLE DOOR

**388-4330DTC**    **\$851**    **\$970**    *\$619*    **109**    **14**    **29.5**    **16**    **42.5**    **42**

**388-4336DTC**    **\$976**    **\$1,113**    *\$629*    **122**    **17**    **35.5**    **16**    **42.5**    **42**

| MODEL | 388  |      | 600       |      | AGD | WEIGHT<br>LBS | CUBE<br>FT <sup>3</sup> | W<br>IN | D<br>IN | 388 |     | 600 |  |
|-------|------|------|-----------|------|-----|---------------|-------------------------|---------|---------|-----|-----|-----|--|
|       | LIST | LIST | LIST      | LIST |     |               |                         |         |         | H   | H   |     |  |
|       | 1"   | 1½"  | UP CHARGE |      |     |               |                         |         |         | 1"  | 1½" |     |  |

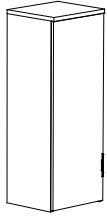

388-4818DTC-L

MATCHES DOUBLE HIGH 48" HUTCH OR 77" HIGH CABINET HEIGHTS. 3 ADJUSTABLE SHELVES.  
SINGLE DOOR - HINGED LEFT

|               |       |       |       |     |    |       |    |       |       |
|---------------|-------|-------|-------|-----|----|-------|----|-------|-------|
| 388-4818DTC-L | \$713 | \$813 | \$488 | 84  | 12 | 17.75 | 16 | 47.25 | 46.75 |
| 388-4824DTC-L | \$752 | \$857 | \$513 | 103 | 19 | 23.75 | 16 | 47.25 | 46.75 |

SINGLE DOOR - HINGED RIGHT

|               |       |       |       |     |    |       |    |       |       |
|---------------|-------|-------|-------|-----|----|-------|----|-------|-------|
| 388-4818DTC-R | \$713 | \$813 | \$488 | 84  | 12 | 17.75 | 16 | 47.25 | 46.75 |
| 388-4824DTC-R | \$752 | \$857 | \$513 | 103 | 19 | 23.75 | 16 | 47.25 | 46.75 |

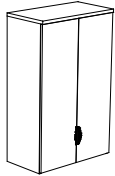

388-4830DTC

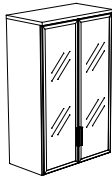

388-4830DTC-AGD-FR

DOUBLE DOOR

|             |         |         |       |     |    |      |    |       |       |
|-------------|---------|---------|-------|-----|----|------|----|-------|-------|
| 388-4830DTC | \$893   | \$1,018 | \$675 | 109 | 20 | 29.5 | 16 | 47.25 | 46.75 |
| 388-4836DTC | \$1,020 | \$1,163 | \$753 | 123 | 21 | 35.5 | 16 | 47.25 | 46.75 |

MATCHES DOUBLE HIGH 55" HUTCH OR 84" HIGH CABINET HEIGHTS. 3 ADJUSTABLE SHELVES.  
SINGLE DOOR - HINGED LEFT

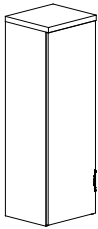

388-5518DTC-L

|               |       |       |       |     |    |       |    |       |       |
|---------------|-------|-------|-------|-----|----|-------|----|-------|-------|
| 388-5518DTC-L | \$792 | \$903 | \$501 | 110 | 14 | 17.75 | 16 | 54.25 | 53.75 |
| 388-5524DTC-L | \$842 | \$960 | \$544 | 130 | 21 | 23.75 | 16 | 54.25 | 53.75 |

SINGLE DOOR - HINGED RIGHT

|               |       |       |       |     |    |       |    |       |       |
|---------------|-------|-------|-------|-----|----|-------|----|-------|-------|
| 388-5518DTC-R | \$792 | \$903 | \$501 | 110 | 14 | 17.75 | 16 | 54.25 | 53.75 |
| 388-5524DTC-R | \$842 | \$960 | \$544 | 130 | 21 | 23.75 | 16 | 54.25 | 53.75 |

DOUBLE DOOR

|             |         |         |       |     |    |      |    |       |       |
|-------------|---------|---------|-------|-----|----|------|----|-------|-------|
| 388-5530DTC | \$1,093 | \$1,246 | \$710 | 155 | 23 | 29.5 | 16 | 54.25 | 53.75 |
| 388-5536DTC | \$1,197 | \$1,365 | \$765 | 165 | 26 | 35.5 | 16 | 54.25 | 53.75 |

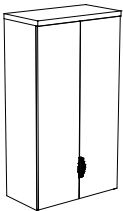

388-5530DTC

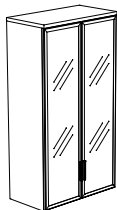

388-5530DTC-AGD-FR

- TO LOCK DESKTOP CABINET DOORS, **ADD AN "L" TO ITEM #** & ADD **\$76** TO RETAIL PRICE.  
**EXAMPLE:** 388-4330DTC-L

**\*\* OPTIONAL ALUMINUM GLAZED DOORS \*\***

- SELECT CLEAR (CL), FROSTED (FR) OR BRONZE (BR) PLEXIGLASS  
**EXAMPLE:** 388-4318DTC-L-AGD-FR
- AGD DOORS INCLUDE SILVER FINISH BAR HANDLES. PLEASE REFER TO PAGE **100-3** FOR OTHER HANDLE SELECTIONS.
- THE PRICE SHOWN FOR AGD DOORS IS AN UP-CHARGE THAT MUST BE ADDED TO THE BASE PRICE OF THE UNIT IT GOES ON.

**EXAMPLE 1:**  
388-UFL2060C  
388-3618DTC-L  
388-3618DTC-R  
388-3624DTS

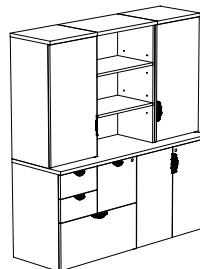

**EXAMPLE 2:**  
388-C2072C  
388-3618DTC-L  
(WITH OPT LOCK)  
388-3618DTC-R  
(WITH OPT LOCK)  
388-3636MS

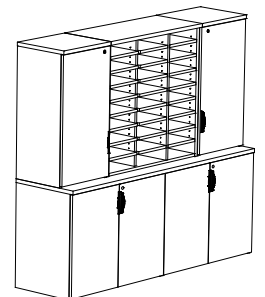

# 388/600 OVERHEAD STORAGE

## OPEN OVERHEAD STORAGE

|       | 388  | 600  |        |                 |    |    | 388 | 600 |
|-------|------|------|--------|-----------------|----|----|-----|-----|
| MODEL | LIST | LIST | WEIGHT | CUBE            | W  | D  | H   | H   |
|       | 1"   | 1½"  | LBS    | FT <sup>3</sup> | IN | IN | 1"  | 1½" |

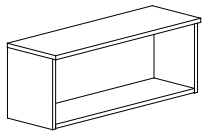

388-1848OS

### OVERHEAD STORAGE - OPEN

#### WALL HUNG

|            |       |       |    |   |       |    |      |    |
|------------|-------|-------|----|---|-------|----|------|----|
| 388-1830OS | \$501 | \$571 | 46 | 2 | 29.5  | 16 | 17.5 | 18 |
| 388-1836OS | \$544 | \$620 | 48 | 2 | 35.5  | 16 | 17.5 | 18 |
| 388-1842OS | \$591 | \$674 | 56 | 2 | 41.5  | 16 | 17.5 | 18 |
| 388-1848OS | \$656 | \$748 | 60 | 2 | 47.25 | 16 | 17.5 | 18 |

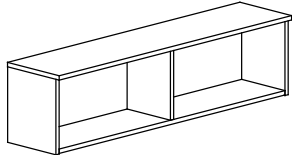

388-1872OS

#### WALL HUNG W/ DIVIDER.

|            |       |         |    |   |       |    |      |    |
|------------|-------|---------|----|---|-------|----|------|----|
| 388-1854OS | \$673 | \$767   | 64 | 3 | 53.25 | 16 | 17.5 | 18 |
| 388-1860OS | \$722 | \$823   | 70 | 3 | 59.25 | 16 | 17.5 | 18 |
| 388-1866OS | \$770 | \$878   | 75 | 4 | 65    | 16 | 17.5 | 18 |
| 388-1872OS | \$888 | \$1,012 | 80 | 4 | 71    | 16 | 17.5 | 18 |

RTA

### DOUBLE HIGH OVERHEAD STORAGE - OPEN

#### WALL HUNG W/ 1 ADJUSTABLE SHELF

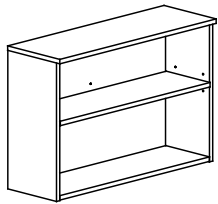

388-3048OS

|            |         |         |     |   |       |    |      |    |
|------------|---------|---------|-----|---|-------|----|------|----|
| 388-3030OS | \$803   | \$915   | 83  | 3 | 29.5  | 16 | 29.5 | 30 |
| 388-3036OS | \$871   | \$993   | 86  | 3 | 35.5  | 16 | 29.5 | 30 |
| 388-3042OS | \$946   | \$1,078 | 101 | 3 | 41.5  | 16 | 29.5 | 30 |
| 388-3048OS | \$1,047 | \$1,194 | 108 | 3 | 47.25 | 16 | 29.5 | 30 |

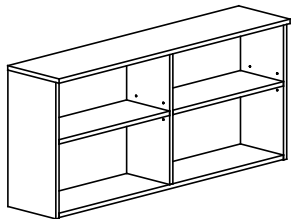

388-3072OS

#### WALL HUNG W/ DIVIDER & 2 ADJUSTABLE SHELVES

|            |         |         |     |     |       |    |      |    |
|------------|---------|---------|-----|-----|-------|----|------|----|
| 388-3054OS | \$1,075 | \$1,226 | 115 | 4.5 | 53.25 | 16 | 29.5 | 30 |
| 388-3060OS | \$1,156 | \$1,318 | 126 | 4.5 | 59.25 | 16 | 29.5 | 30 |
| 388-3066OS | \$1,231 | \$1,403 | 135 | 6   | 65    | 16 | 29.5 | 30 |
| 388-3072OS | \$1,419 | \$1,618 | 144 | 6   | 71    | 16 | 29.5 | 30 |

- ALL DOUBLE HIGH OVERHEADS CAN BE ORDERED **NO WIDER THAN 72"**.

RTA

### RECORD DIVIDERS

OPTIONAL RECORD DIVIDERS AVAILABLE. SET OF 6

100-RD **\$99**

- COMPONENTS ARE NOT DRILLED FOR RECORD DIVIDERS UNLESS SPECIFIED AT THE TIME OF ORDER ON PO.

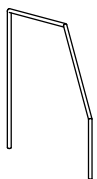



| MODEL | 388  |      | 600       |      | AGD | WEIGHT | CUBE | W | D | 388 |    | 600 |    |
|-------|------|------|-----------|------|-----|--------|------|---|---|-----|----|-----|----|
|       | LIST | LIST | LIST      | LIST |     |        |      |   |   | H   | H  |     |    |
|       | 1"   | 1½"  | UP CHARGE | LBS  |     |        |      |   |   | FT³ | IN | IN  | 1" |

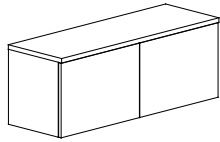

388-1848OSHD

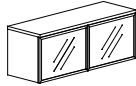

388-1848OSHD-AGD

**OVERHEAD STORAGE - W/ HINGED DOORS**

WALL HUNG. DOORS SHIP IN A SECOND CARTON.

|              |       |         |       |    |     |       |    |      |    |
|--------------|-------|---------|-------|----|-----|-------|----|------|----|
| 388-1830OSHD | \$742 | \$846   | \$420 | 56 | 2.5 | 29.5  | 16 | 17.5 | 18 |
| 388-1836OSHD | \$782 | \$891   | \$466 | 61 | 2.5 | 35.5  | 16 | 17.5 | 18 |
| 388-1842OSHD | \$837 | \$954   | \$513 | 71 | 2.5 | 41.5  | 16 | 17.5 | 18 |
| 388-1848OSHD | \$896 | \$1,021 | \$532 | 78 | 2.5 | 47.25 | 16 | 17.5 | 18 |

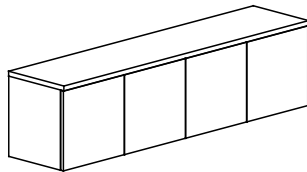

388-1872OSHD

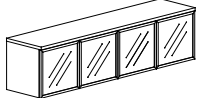

388-1872OSHD-AGD

WALL HUNG W/ DIVIDER. DOORS SHIP IN A SECOND CARTON.

|              |         |         |       |     |     |       |    |      |    |
|--------------|---------|---------|-------|-----|-----|-------|----|------|----|
| 388-1854OSHD | \$1,067 | \$1,216 | \$814 | 84  | 3.8 | 53.25 | 16 | 17.5 | 18 |
| 388-1860OSHD | \$1,145 | \$1,305 | \$834 | 93  | 3.8 | 59.25 | 16 | 17.5 | 18 |
| 388-1866OSHD | \$1,171 | \$1,335 | \$886 | 100 | 5   | 65    | 16 | 17.5 | 18 |
| 388-1872OSHD | \$1,290 | \$1,471 | \$893 | 110 | 5   | 71    | 16 | 17.5 | 18 |

**RTA**

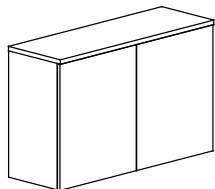

388-3048OSHD

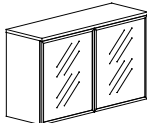

388-3048OSHD-AGD

**DOUBLE HIGH OVERHEAD STORAGE - W/ HINGED DOORS**

WALL HUNG W/ 1 ADJUSTABLE SHELF. DOORS SHIP IN A SECOND CARTON.

|              |         |         |       |     |     |       |    |      |    |
|--------------|---------|---------|-------|-----|-----|-------|----|------|----|
| 388-3030OSHD | \$1,163 | \$1,326 | \$591 | 101 | 3.5 | 29.5  | 16 | 29.5 | 30 |
| 388-3036OSHD | \$1,230 | \$1,402 | \$676 | 108 | 3.5 | 35.5  | 16 | 29.5 | 30 |
| 388-3042OSHD | \$1,304 | \$1,487 | \$742 | 126 | 3.5 | 41.5  | 16 | 29.5 | 30 |
| 388-3048OSHD | \$1,405 | \$1,602 | \$809 | 137 | 3.6 | 47.25 | 16 | 29.5 | 30 |

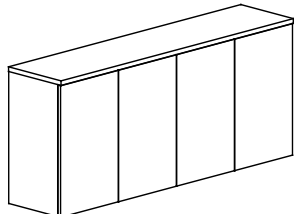

388-3072OSHD

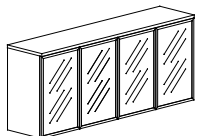

388-3072OSHD-AGD

WALL HUNG W/ DIVIDER & 2 ADJUSTABLE SHELVES. DOORS SHIP IN A SECOND CARTON.

|              |         |         |         |     |     |       |    |      |    |
|--------------|---------|---------|---------|-----|-----|-------|----|------|----|
| 388-3054OSHD | \$1,712 | \$1,952 | \$1,110 | 149 | 5.2 | 53.25 | 16 | 29.5 | 30 |
| 388-3060OSHD | \$1,790 | \$2,041 | \$1,176 | 164 | 5.3 | 59.25 | 16 | 29.5 | 30 |
| 388-3066OSHD | \$1,863 | \$2,124 | \$1,268 | 177 | 6.8 | 65    | 16 | 29.5 | 30 |
| 388-3072OSHD | \$2,053 | \$2,340 | \$1,293 | 189 | 6.9 | 71    | 16 | 29.5 | 30 |

**\*\* OPTIONAL ALUMINUM GLAZED DOORS \*\***

- SELECT CLEAR (CL), FROSTED (FR) OR BRONZE (BR) PLEXIGLASS  
**EXAMPLE:** 388-3072OSHD-AGD-BR
- TO LOCK OVERHEAD STORAGE DOORS, **ADD AN "-L" TO ITEM #** & ADD **\$76** TO RETAIL PRICE.  
**EXAMPLE:** 388-3072OSHD-L
- OVERHEAD STORAGE DOORS **DO NOT** REQUIRE HANDLES. TO ADD HANDLES PLEASE REFER TO PAGE **100-3**.
- THE PRICE SHOWN FOR AGD DOORS IS AN UP-CHARGE THAT MUST BE ADDED TO THE BASE PRICE OF THE UNIT IT GOES ON.
- ALL DOUBLE HIGH OVERHEADS CAN BE ORDERED **NO WIDER THAN 72"**.

**RTA**

# 388/600 OVERHEAD STORAGE

## FLIPPER DOOR OVERHEAD STORAGE

|       | 388  | 600  |        |                 |    |    | 388 | 600 |
|-------|------|------|--------|-----------------|----|----|-----|-----|
| MODEL | LIST | LIST | WEIGHT | CUBE            | W  | D  | H   | H   |
|       | 1"   | 1½"  | LBS    | FT <sup>3</sup> | IN | IN | 1"  | 1½" |

### OVERHEAD STORAGE - W/ FLIPPER DOORS DOORS

WALL HUNG W/ 1 FLIPPER DOOR.

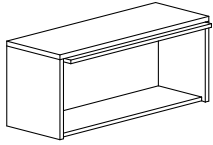

388-1848OSFD

|              |              |              |    |   |       |    |      |    |
|--------------|--------------|--------------|----|---|-------|----|------|----|
| 388-1830OSFD | <b>\$729</b> | <b>\$831</b> | 51 | 2 | 29.5  | 16 | 17.5 | 18 |
| 388-1836OSFD | <b>\$770</b> | <b>\$878</b> | 60 | 2 | 35.5  | 16 | 17.5 | 18 |
| 388-1842OSFD | <b>\$816</b> | <b>\$930</b> | 69 | 2 | 41.5  | 16 | 17.5 | 18 |
| 388-1848OSFD | <b>\$872</b> | <b>\$994</b> | 80 | 2 | 47.25 | 16 | 17.5 | 18 |

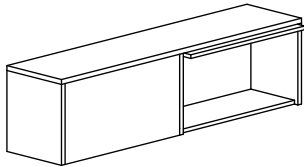

388-1872OSFD

WALL HUNG W/ DIVIDER & 2 FLIPPER DOORS.

|              |                |                |     |   |       |    |      |    |
|--------------|----------------|----------------|-----|---|-------|----|------|----|
| 388-1854OSFD | <b>\$995</b>   | <b>\$1,134</b> | 90  | 3 | 53.25 | 16 | 17.5 | 18 |
| 388-1860OSFD | <b>\$1,082</b> | <b>\$1,233</b> | 100 | 3 | 59.25 | 16 | 17.5 | 18 |
| 388-1866OSFD | <b>\$1,141</b> | <b>\$1,301</b> | 110 | 4 | 65    | 16 | 17.5 | 18 |
| 388-1872OSFD | <b>\$1,260</b> | <b>\$1,436</b> | 120 | 4 | 71    | 16 | 17.5 | 18 |

**RTA**

- ON ALL OVERHEAD STORAGES, CARE SHOULD BE TAKEN TO MOUNT UNITS SECURELY TO WALL. ALL UNITS INCLUDE FRENCH CLEAT CONNECTION. WALL ATTACHMENT HARDWARE IS NOT INCLUDED AS WALL MOUNTING HARDWARE WILL DEPEND ON WALL MATERIAL.

| MODEL | 388  | 600  | WEIGHT | CUBE | W | D | 388 | 600 |
|-------|------|------|--------|------|---|---|-----|-----|
|       | LIST | LIST |        |      |   |   | H   | H   |
|       | 1"   | 1½"  |        |      |   |   | 1"  | 1½" |

**STACKING BOOKCASE**

- STACK ON TOP OF NO-TOP UNITS. **FOR EXAMPLE** 388-18", 24" 30" OR 36" WIDE DCLHX, DCX, LFX, UFLX OR CX TO CREATE A 65", 71" OR 84" HIGH COMBO UNIT.

MATCHES 47" CABINET HEIGHT WHEN PLACED ON NO TOP UNITS. 1 ADJUSTABLE SHELF.

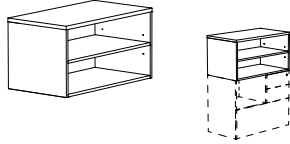

|                |       |       |    |    |       |       |       |       |
|----------------|-------|-------|----|----|-------|-------|-------|-------|
| 388-1916SBK-19 | \$605 | \$690 | 62 | 4  | 15.75 | 18.75 | 18.75 | 18.75 |
| 388-1924SBK-19 | \$640 | \$730 | 70 | 5  | 23.75 | 18.75 | 18.75 | 18.75 |
| 388-1930SBK-19 | \$700 | \$798 | 76 | 8  | 29.5  | 18.75 | 18.75 | 18.75 |
| 388-1936SBK-19 | \$776 | \$885 | 82 | 10 | 35.5  | 18.75 | 18.75 | 18.75 |

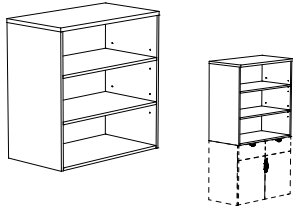

MATCHES 36" HUTCH OR 65" CABINET HEIGHTS WHEN PLACED ON NO TOP UNITS. 2 ADJUSTABLE SHELVES.

|                |       |         |     |    |       |       |      |      |
|----------------|-------|---------|-----|----|-------|-------|------|------|
| 388-3716SBK-19 | \$730 | \$832   | 122 | 11 | 15.75 | 18.75 | 36.5 | 36.5 |
| 388-3724SBK-19 | \$800 | \$912   | 152 | 15 | 23.75 | 18.75 | 36.5 | 36.5 |
| 388-3730SBK-19 | \$921 | \$1,050 | 175 | 18 | 29.5  | 18.75 | 36.5 | 36.5 |
| 388-3736SBK-19 | \$983 | \$1,121 | 200 | 20 | 35.5  | 18.75 | 36.5 | 36.5 |

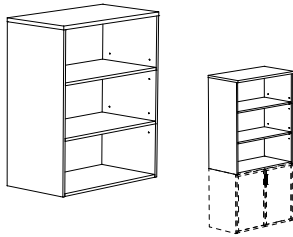

MATCHES 43" HUTCH OR 72" CABINET HEIGHTS WHEN PLACED ON NO TOP UNITS. 2 ADJUSTABLE SHELVES.

|                |         |         |     |    |       |       |      |      |
|----------------|---------|---------|-----|----|-------|-------|------|------|
| 388-4416SBK-19 | \$806   | \$919   | 138 | 12 | 15.75 | 18.75 | 43.5 | 43.5 |
| 388-4424SBK-19 | \$863   | \$984   | 168 | 16 | 23.75 | 18.75 | 43.5 | 43.5 |
| 388-4430SBK-19 | \$981   | \$1,118 | 193 | 20 | 29.5  | 18.75 | 43.5 | 43.5 |
| 388-4436SBK-19 | \$1,012 | \$1,154 | 211 | 22 | 35.5  | 18.75 | 43.5 | 43.5 |

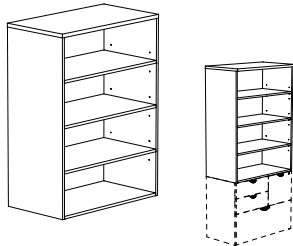

MATCHES DOUBLE HIGH 48" HUTCH OR 77" HIGH CABINET HEIGHTS WHEN PLACED ON NO TOP UNITS. 3 ADJUSTABLE SHELVES.

|                |         |         |     |      |       |       |       |       |
|----------------|---------|---------|-----|------|-------|-------|-------|-------|
| 388-4924SBK-19 | \$899   | \$1,025 | 180 | 17   | 23.75 | 18.75 | 48.25 | 48.25 |
| 388-4930SBK-19 | \$1,005 | \$1,146 | 193 | 20.5 | 29.5  | 18.75 | 48.25 | 48.25 |
| 388-4936SBK-19 | \$1,039 | \$1,184 | 221 | 22.5 | 35.5  | 18.75 | 48.25 | 48.25 |

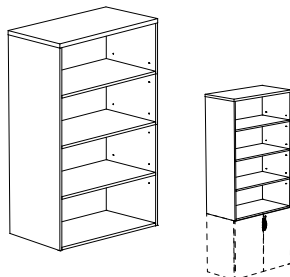

MATCHES DOUBLE HIGH 55" HUTCH OR 84" CABINET HEIGHTS WHEN PLACED ON NO TOP UNITS. 3 ADJUSTABLE SHELVES.

|                |         |         |     |    |       |       |       |       |
|----------------|---------|---------|-----|----|-------|-------|-------|-------|
| 388-5624SBK-19 | \$922   | \$1,051 | 192 | 18 | 23.75 | 18.75 | 55.25 | 55.25 |
| 388-5630SBK-19 | \$1,022 | \$1,165 | 201 | 21 | 29.5  | 18.75 | 55.25 | 55.25 |
| 388-5636SBK-19 | \$1,076 | \$1,227 | 235 | 23 | 35.5  | 18.75 | 55.25 | 55.25 |

# 388/600 STACKING STORAGE

## STACKING HINGED DOOR CABINET



| MODEL | 388  |      | 600       |     | AGD | WEIGHT | CUBE | W | D | 388             |    | 600 |   |   |
|-------|------|------|-----------|-----|-----|--------|------|---|---|-----------------|----|-----|---|---|
|       | LIST | LIST | UP CHARGE | LBS |     |        |      |   |   | FT <sup>3</sup> | IN | IN  | H | H |
|       | 1"   | 1½"  |           |     |     |        |      |   |   |                 | 1" | 1½" |   |   |

### STACKING CABINET

MATCHES 47" CABINET HEIGHT WHEN STACKED ON A NO TOP UNIT. 1 ADJUSTABLE SHELF.

SINGLE DOOR - HINGED LEFT

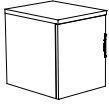

388-1916STC-L-19

|                  |       |       |       |    |   |       |       |       |       |
|------------------|-------|-------|-------|----|---|-------|-------|-------|-------|
| 388-1916STC-L-19 | \$730 | \$832 | \$318 | 72 | 4 | 15.75 | 18.75 | 18.75 | 18.75 |
| 388-1924STC-L-19 | \$765 | \$872 | \$331 | 79 | 5 | 23.75 | 18.75 | 18.75 | 18.75 |

SINGLE DOOR - HINGED RIGHT

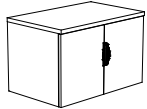

388-1930STC-19

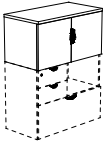

|                  |       |       |       |    |   |       |       |       |       |
|------------------|-------|-------|-------|----|---|-------|-------|-------|-------|
| 388-1916STC-R-19 | \$730 | \$832 | \$318 | 72 | 4 | 15.75 | 18.75 | 18.75 | 18.75 |
| 388-1924STC-R-19 | \$765 | \$872 | \$331 | 79 | 5 | 23.75 | 18.75 | 18.75 | 18.75 |

DOUBLE DOOR

|                |       |         |       |    |    |      |       |       |       |
|----------------|-------|---------|-------|----|----|------|-------|-------|-------|
| 388-1930STC-19 | \$826 | \$942   | \$552 | 85 | 8  | 29.5 | 18.75 | 18.75 | 18.75 |
| 388-1936STC-19 | \$900 | \$1,026 | \$613 | 92 | 10 | 35.5 | 18.75 | 18.75 | 18.75 |

MATCHES 36" HUTCH OR 65" CABINET HEIGHTS WHEN STACKED ON A NO TOP UNIT. 2 ADJUSTABLE SHELVES.

SINGLE DOOR - HINGED LEFT



388-3716STC-L-19

|                  |       |         |       |     |    |       |       |      |      |
|------------------|-------|---------|-------|-----|----|-------|-------|------|------|
| 388-3716STC-L-19 | \$855 | \$975   | \$420 | 134 | 11 | 15.75 | 18.75 | 36.5 | 36.5 |
| 388-3724STC-L-19 | \$924 | \$1,053 | \$456 | 152 | 15 | 23.75 | 18.75 | 36.5 | 36.5 |

SINGLE DOOR - HINGED RIGHT

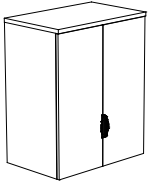

388-3730STC-19

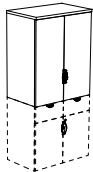

|                  |       |         |       |     |    |       |       |      |      |
|------------------|-------|---------|-------|-----|----|-------|-------|------|------|
| 388-3716STC-R-19 | \$855 | \$975   | \$420 | 134 | 11 | 15.75 | 18.75 | 36.5 | 36.5 |
| 388-3724STC-R-19 | \$924 | \$1,053 | \$456 | 152 | 15 | 23.75 | 18.75 | 36.5 | 36.5 |

DOUBLE DOOR

|                |         |         |       |     |    |      |       |      |      |
|----------------|---------|---------|-------|-----|----|------|-------|------|------|
| 388-3730STC-19 | \$1,011 | \$1,153 | \$589 | 167 | 18 | 29.5 | 18.75 | 36.5 | 36.5 |
| 388-3736STC-19 | \$1,072 | \$1,222 | \$622 | 172 | 20 | 35.5 | 18.75 | 36.5 | 36.5 |

MATCHES 43" HUTCH OR 72" CABINET HEIGHTS WHEN STACKED ON A NO TOP UNIT. 2 ADJUSTABLE SHELVES.

SINGLE DOOR - HINGED LEFT



388-4416STC-L-19

|                  |         |         |       |     |    |       |       |      |      |
|------------------|---------|---------|-------|-----|----|-------|-------|------|------|
| 388-4416STC-L-19 | \$933   | \$1,064 | \$455 | 149 | 12 | 15.75 | 18.75 | 43.5 | 43.5 |
| 388-4424STC-L-19 | \$1,205 | \$1,374 | \$477 | 171 | 16 | 23.75 | 18.75 | 43.5 | 43.5 |

SINGLE DOOR - HINGED RIGHT

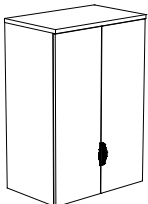

388-4430STC-19

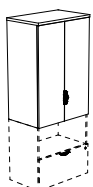

|                  |         |         |       |     |    |       |       |      |      |
|------------------|---------|---------|-------|-----|----|-------|-------|------|------|
| 388-4416STC-R-19 | \$933   | \$1,064 | \$455 | 149 | 12 | 15.75 | 18.75 | 43.5 | 43.5 |
| 388-4424STC-R-19 | \$1,205 | \$1,374 | \$477 | 171 | 16 | 23.75 | 18.75 | 43.5 | 43.5 |

DOUBLE DOOR

|                |         |         |       |     |      |      |       |      |      |
|----------------|---------|---------|-------|-----|------|------|-------|------|------|
| 388-4430STC-19 | \$1,262 | \$1,439 | \$629 | 180 | 20.5 | 29.5 | 18.75 | 43.5 | 43.5 |
| 388-4436STC-19 | \$1,301 | \$1,483 | \$682 | 187 | 22.5 | 35.5 | 18.75 | 43.5 | 43.5 |

| MODEL | 388  |      | 600       |     | AGD | WEIGHT | CUBE | W | D | 388             |    | 600 |    |     |
|-------|------|------|-----------|-----|-----|--------|------|---|---|-----------------|----|-----|----|-----|
|       | LIST | LIST | UP CHARGE | LBS |     |        |      |   |   | FT <sup>3</sup> | IN | IN  | H  | H   |
|       | 1"   | 1½"  |           |     |     |        |      |   |   |                 |    |     | 1" | 1½" |



388-4924STC-L-19

MATCHES DOUBLE HIGH 48" HUTCH OR 77" HIGH CABINET HEIGHTS WHEN STACKED ON A NO TOP UNIT. 3 ADJUSTABLE SHELVES.

SINGLE DOOR - HINGED LEFT

**388-4924STC-L-19**    **\$1,282**    **\$1,461**    \$552    172    17    23.75    18.75    **48.75**    48.75

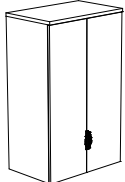

SINGLE DOOR - HINGED RIGHT

**388-4924STC-R-19**    **\$1,282**    **\$1,461**    \$552    172    17    23.75    18.75    **48.75**    48.75

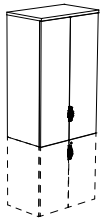

DOUBLE DOOR

**388-4930STC-19**    **\$1,362**    **\$1,553**    \$706    192    20.5    29.5    18.75    **48.75**    48.75

388-4930STC-19

**388-4936STC-19**    **\$1,401**    **\$1,597**    \$742    200    22.5    35.5    18.75    **48.75**    48.75



388-5624STC-L-19

MATCHES DOUBLE HIGH 55" HUTCH OR 84" CABINET HEIGHTS WHEN PLACED ON NO TOP UNITS. 3 ADJUSTABLE SHELVES.

SINGLE DOOR - HINGED LEFT

**388-5624STC-L-19**    **\$1,315**    **\$1,499**    \$601    181    18    23.75    18.75    **55.25**    55.25

SINGLE DOOR - HINGED RIGHT

**388-5624STC-R-19**    **\$1,315**    **\$1,499**    \$601    181    18    23.75    18.75    **55.25**    55.25

DOUBLE DOOR

**388-5630STC-19**    **\$1,377**    **\$1,570**    \$826    197    21    29.5    18.75    **55.25**    55.25

388-5630STC-19

**388-5636STC-19**    **\$1,418**    **\$1,617**    \$861    205    23    35.5    18.75    **55.25**    55.25

STACK ON TOP OF NO-TOP UNITS. FOR EXAMPLE 388-18", 24" 30" OR 36" WIDE DCLHX, DCX, LFX, UFLX OR CX TO CREATE A 65", 71" OR 84" HIGH COMBO UNIT.

**\*OPTIONAL ALUMINUM GLAZED DOORS\***

- SELECT CLEAR (CL), FROSTED (FR) OR BRONZE (BR) PLEXIGLASS  
**EXAMPLE: 388-3736STC-AGD-FR**
- AGD DOORS INCLUDE SILVER FINISH BAR HANDLES. PLEASE REFER TO PAGE 100-3 FOR OTHER HANDLE SELECTIONS.
- THE PRICE SHOWN FOR AGD DOORS IS AN UP-CHARGE THAT MUST BE ADDED TO THE BASE PRICE OF THE UNIT IT GOES ON.

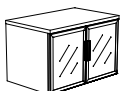

388-1930STC-19-AGD-BR

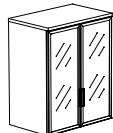

388-3730STC-19-AGD-BR



388-4430STC-19-AGD-BR

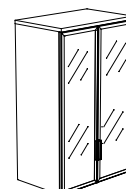

388-4930STC-19-AGD-FR

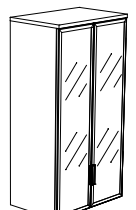

388-5630STC-19-AGD-FR

# 388 FLIP TOP STORAGE BENCH

| MODEL | 388  |        | 388             |    |    |    |  |
|-------|------|--------|-----------------|----|----|----|--|
|       | LIST | WEIGHT | CUBE            | W  | D  | H  |  |
|       | 1"   | LBS    | FT <sup>3</sup> | IN | IN | 1" |  |

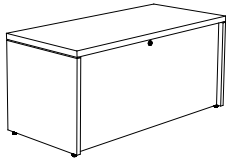

388-1836BFT-L

### FLIP TOP STORAGE BENCH

|             |       |      |      |       |       |       |
|-------------|-------|------|------|-------|-------|-------|
| 388-1818BFT | \$746 | 32.2 | 0.90 | 17.75 | 17.75 | 17.25 |
| 388-2424BFT | \$806 | 68.8 | 1.58 | 23.75 | 23.75 | 17.25 |
| 388-1824BFT | \$780 | 44.6 | 1.19 | 23.75 | 17.75 | 17.25 |
| 388-1836BFT | \$837 | 61.9 | 1.33 | 35.5  | 17.75 | 17.25 |
| 388-1848BFT | \$922 | 79.1 | 1.77 | 47.25 | 17.75 | 17.25 |

- TO LOCK BENCHES, ADD AN "-L" TO SKU AND AN UPCHARGE OF **\$76**  
**EXAMPLE:** 388-1836BFT-L
- SHIPS FULLY ASSEMBLED

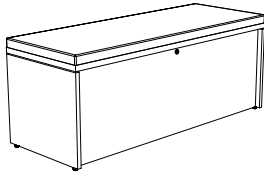

388-1848BFT-L &  
388-1848BFT-CUSH

### BENCH CUSHION

|                  |       |      |      |       |       |      |
|------------------|-------|------|------|-------|-------|------|
| 388-1818BFT-CUSH | \$393 | 8.2  | 0.33 | 17.75 | 17.75 | 1.75 |
| 388-2424BFT-CUSH | \$424 | 14.5 | 0.59 | 23.75 | 23.75 | 1.75 |
| 388-1824BFT-CUSH | \$411 | 10.9 | 0.44 | 23.75 | 17.75 | 1.75 |
| 388-1836BFT-CUSH | \$467 | 16.4 | 0.66 | 35.5  | 17.75 | 1.75 |
| 388-1848BFT-CUSH | \$533 | 21.8 | 0.87 | 47.25 | 17.75 | 1.75 |

# BOOKCASES

| MODEL | 388  |      | 600    |                 | 388 |    |    | 600 |  |
|-------|------|------|--------|-----------------|-----|----|----|-----|--|
|       | LIST | LIST | WEIGHT | CUBE            | W   | D  | H  | H   |  |
|       | 1"   | 1½"  | LBS    | FT <sup>3</sup> | IN  | IN | 1" | 1½" |  |

### BOOKCASES

1 FIXED SHELF & 1 ADJUSTABLE SHELF

|            |       |       |    |    |      |       |      |      |
|------------|-------|-------|----|----|------|-------|------|------|
| 388-3636BK | \$675 | \$716 | 70 | 11 | 35.5 | 12.75 | 35.5 | 35.5 |
|------------|-------|-------|----|----|------|-------|------|------|

1 FIXED SHELF & 2 ADJUSTABLE SHELVES

|            |       |       |    |    |      |       |       |       |
|------------|-------|-------|----|----|------|-------|-------|-------|
| 388-4836BK | \$815 | \$864 | 95 | 14 | 35.5 | 12.75 | 47.75 | 47.75 |
|------------|-------|-------|----|----|------|-------|-------|-------|

2 FIXED SHELVES & 2 ADJUSTABLE SHELVES

|            |       |       |     |    |      |       |      |      |
|------------|-------|-------|-----|----|------|-------|------|------|
| 388-6536BK | \$868 | \$920 | 105 | 18 | 35.5 | 12.75 | 64.5 | 64.5 |
|------------|-------|-------|-----|----|------|-------|------|------|

2 FIXED SHELVES & 3 ADJUSTABLE SHELVES

|            |       |         |     |    |      |       |      |      |
|------------|-------|---------|-----|----|------|-------|------|------|
| 388-7236BK | \$988 | \$1,047 | 125 | 20 | 35.5 | 12.75 | 71.5 | 71.5 |
|------------|-------|---------|-----|----|------|-------|------|------|

#### NOTE:

- BOOKCASES HAVE MATCHING COLOURED, ¾" BACKS.

### BOOKCASE SHELF

W/ 4 SHELF CLIPS

|             |       |       |   |   |      |       |   |   |
|-------------|-------|-------|---|---|------|-------|---|---|
| 388-1236BKS | \$127 | \$127 | 9 | 1 | 33.5 | 11.75 | 1 | 1 |
|-------------|-------|-------|---|---|------|-------|---|---|

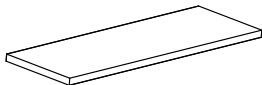
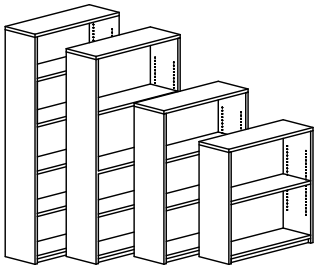

|       | 388  | 600  |        |                 |    |    | 388 | 600 |
|-------|------|------|--------|-----------------|----|----|-----|-----|
| MODEL | LIST | LIST | WEIGHT | CUBE            | W  | D  | H   | H   |
|       | 1"   | 1½"  | LBS    | FT <sup>3</sup> | IN | IN | 1"  | 1½" |

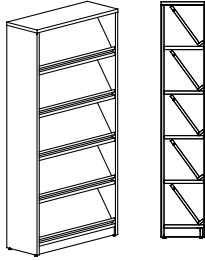

**DISPLAY BOOKCASE**

W/ 5 ANGLED DISPLAY SHELVES. SHIPS IN 2 CARTONS

|                    |                |                |     |    |      |      |             |           |
|--------------------|----------------|----------------|-----|----|------|------|-------------|-----------|
| <b>388-7336DBK</b> | <b>\$1,312</b> | <b>\$1,391</b> | 150 | 20 | 35.5 | 13.5 | <b>73.5</b> | <b>74</b> |
|--------------------|----------------|----------------|-----|----|------|------|-------------|-----------|

- EACH SHELF LIFTS TO EXPOSE STORAGE BEHIND

**CURVED SINGLE-SIDED BOOKCASE**

32" HIGH

|                     |                |     |      |       |       |       |             |     |
|---------------------|----------------|-----|------|-------|-------|-------|-------------|-----|
| <b>388-3236CSBK</b> | <b>\$1,012</b> | N/A | 97.0 | 13.17 | 36.75 | 15.75 | <b>31.5</b> | N/A |
|---------------------|----------------|-----|------|-------|-------|-------|-------------|-----|

|                     |                |     |       |       |    |      |             |     |
|---------------------|----------------|-----|-------|-------|----|------|-------------|-----|
| <b>388-3272CSBK</b> | <b>\$2,027</b> | N/A | 165.3 | 33.32 | 71 | 21.5 | <b>31.5</b> | N/A |
|---------------------|----------------|-----|-------|-------|----|------|-------------|-----|

46" HIGH

|                     |                |     |       |      |       |       |             |     |
|---------------------|----------------|-----|-------|------|-------|-------|-------------|-----|
| <b>388-4636CSBK</b> | <b>\$1,268</b> | N/A | 116.8 | 18.6 | 36.75 | 15.75 | <b>45.5</b> | N/A |
|---------------------|----------------|-----|-------|------|-------|-------|-------------|-----|

|                     |                |     |       |       |    |      |             |     |
|---------------------|----------------|-----|-------|-------|----|------|-------------|-----|
| <b>388-4672CSBK</b> | <b>\$2,836</b> | N/A | 220.5 | 47.04 | 71 | 21.5 | <b>45.5</b> | N/A |
|---------------------|----------------|-----|-------|-------|----|------|-------------|-----|

60" HIGH

|                     |                |     |       |       |       |       |              |     |
|---------------------|----------------|-----|-------|-------|-------|-------|--------------|-----|
| <b>388-6036CSBK</b> | <b>\$1,647</b> | N/A | 141.1 | 24.02 | 36.75 | 15.75 | <b>59.25</b> | N/A |
|---------------------|----------------|-----|-------|-------|-------|-------|--------------|-----|

|                     |                |     |       |       |    |      |              |     |
|---------------------|----------------|-----|-------|-------|----|------|--------------|-----|
| <b>388-6072CSBK</b> | <b>\$3,688</b> | N/A | 253.5 | 60.76 | 71 | 21.5 | <b>59.25</b> | N/A |
|---------------------|----------------|-----|-------|-------|----|------|--------------|-----|

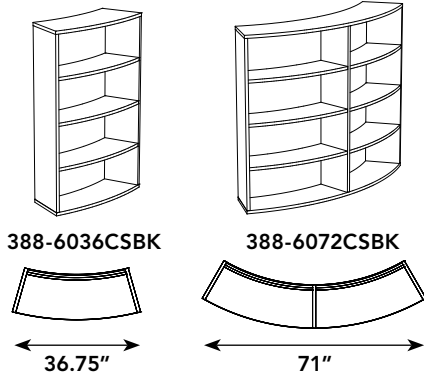

**CURVED DOUBLE-SIDED BOOKCASE**

32" HIGH

|                     |                |     |       |       |       |       |             |     |
|---------------------|----------------|-----|-------|-------|-------|-------|-------------|-----|
| <b>388-3236CDBK</b> | <b>\$1,519</b> | N/A | 178.6 | 21.66 | 36.75 | 27.25 | <b>31.5</b> | N/A |
|---------------------|----------------|-----|-------|-------|-------|-------|-------------|-----|

|                     |                |     |        |       |    |       |             |     |
|---------------------|----------------|-----|--------|-------|----|-------|-------------|-----|
| <b>388-3272CDBK</b> | <b>\$3,038</b> | N/A | 291.01 | 47.20 | 71 | 31.75 | <b>31.5</b> | N/A |
|---------------------|----------------|-----|--------|-------|----|-------|-------------|-----|

46" HIGH

|                     |                |     |       |       |       |       |             |     |
|---------------------|----------------|-----|-------|-------|-------|-------|-------------|-----|
| <b>388-4636CDBK</b> | <b>\$2,028</b> | N/A | 187.4 | 30.58 | 36.75 | 27.25 | <b>45.5</b> | N/A |
|---------------------|----------------|-----|-------|-------|-------|-------|-------------|-----|

|                     |                |     |       |       |    |       |             |     |
|---------------------|----------------|-----|-------|-------|----|-------|-------------|-----|
| <b>388-4672CDBK</b> | <b>\$4,351</b> | N/A | 341.7 | 66.64 | 71 | 31.75 | <b>45.5</b> | N/A |
|---------------------|----------------|-----|-------|-------|----|-------|-------------|-----|

60" HIGH

|                     |                |     |       |       |       |       |              |     |
|---------------------|----------------|-----|-------|-------|-------|-------|--------------|-----|
| <b>388-6036CDBK</b> | <b>\$2,389</b> | N/A | 220.5 | 39.49 | 36.75 | 27.25 | <b>59.25</b> | N/A |
|---------------------|----------------|-----|-------|-------|-------|-------|--------------|-----|

|                     |                |     |       |       |    |       |              |     |
|---------------------|----------------|-----|-------|-------|----|-------|--------------|-----|
| <b>388-6072CDBK</b> | <b>\$5,035</b> | N/A | 390.2 | 86.08 | 71 | 31.75 | <b>59.25</b> | N/A |
|---------------------|----------------|-----|-------|-------|----|-------|--------------|-----|

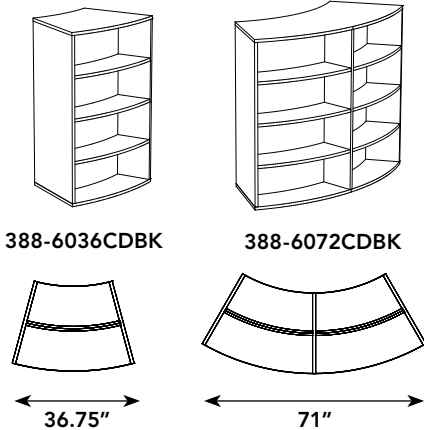

# CURVED BOOKCASES - MOBILE

|       | 388  | 600  |        |                 |    |    | 388 | 600 |
|-------|------|------|--------|-----------------|----|----|-----|-----|
| MODEL | LIST | LIST | WEIGHT | CUBE            | W  | D  | H   | H   |
|       | 1"   | 1½"  | LBS    | FT <sup>3</sup> | IN | IN | 1"  | 1½" |

## CURVED SINGLE-SIDED MOBILE BOOKCASE

32" HIGH

|                |         |     |       |       |       |       |      |     |
|----------------|---------|-----|-------|-------|-------|-------|------|-----|
| 388-3236CSBK-M | \$1,138 | N/A | 97.0  | 13.17 | 36.75 | 15.75 | 31.5 | N/A |
| 388-3272CSBK-M | \$2,151 | N/A | 165.3 | 33.32 | 71    | 21.5  | 31.5 | N/A |

46" HIGH

|                |         |     |       |       |       |       |      |     |
|----------------|---------|-----|-------|-------|-------|-------|------|-----|
| 388-4636CSBK-M | \$1,392 | N/A | 116.8 | 18.6  | 36.75 | 15.75 | 45.5 | N/A |
| 388-4672CSBK-M | \$2,963 | N/A | 220.5 | 47.04 | 71    | 21.5  | 45.5 | N/A |

60" HIGH

|                |         |     |       |       |       |       |       |     |
|----------------|---------|-----|-------|-------|-------|-------|-------|-----|
| 388-6036CSBK-M | \$1,772 | N/A | 141.1 | 24.02 | 36.75 | 15.75 | 59.25 | N/A |
| 388-6072CSBK-M | \$3,813 | N/A | 253.5 | 60.76 | 71    | 21.5  | 59.25 | N/A |

- INCLUDES HEAVY-DUTY LOCKING CASTERS

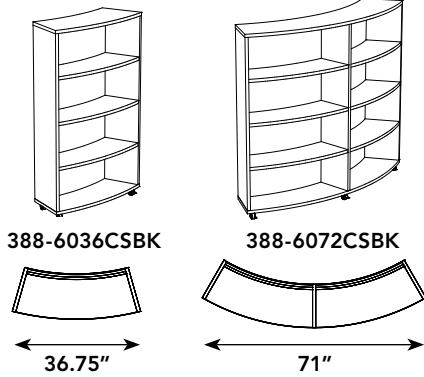

## CURVED DOUBLE-SIDED MOBILE BOOKCASE

32" HIGH

|                |         |     |       |       |       |       |      |     |
|----------------|---------|-----|-------|-------|-------|-------|------|-----|
| 388-3236CDBK-M | \$1,644 | N/A | 178.6 | 21.66 | 36.75 | 27.25 | 31.5 | N/A |
| 388-3272CDBK-M | \$3,163 | N/A | 291.0 | 47.20 | 71    | 31.75 | 31.5 | N/A |

46" HIGH

|                |         |     |       |       |       |       |      |     |
|----------------|---------|-----|-------|-------|-------|-------|------|-----|
| 388-4636CDBK-M | \$2,152 | N/A | 187.4 | 30.58 | 36.75 | 27.25 | 45.5 | N/A |
| 388-4672CDBK-M | \$4,475 | N/A | 341.7 | 66.64 | 71    | 31.75 | 45.5 | N/A |

60" HIGH

|                |         |     |       |       |       |       |       |     |
|----------------|---------|-----|-------|-------|-------|-------|-------|-----|
| 388-6036CDBK-M | \$2,513 | N/A | 220.5 | 39.49 | 36.75 | 27.25 | 59.25 | N/A |
| 388-6072CDBK-M | \$5,160 | N/A | 390.2 | 86.08 | 71    | 31.75 | 59.25 | N/A |

- INCLUDES HEAVY-DUTY LOCKING CASTERS

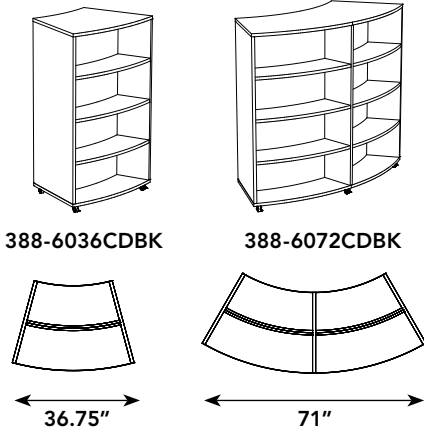



|       | 388  | 600  |        |                 |    |    |    | 388 | 600 |
|-------|------|------|--------|-----------------|----|----|----|-----|-----|
| MODEL | LIST | LIST | WEIGHT | CUBE            | W  | D  | H  | H   |     |
|       | 1"   | 1½"  | LBS    | FT <sup>3</sup> | IN | IN | 1" | 1½" |     |

(IF ORDERED WITH A GRAINED FINISH) CORNER SHELVES ARE DESIGNED TO HAVE THE GRAIN RUN PARALLEL TO THE WALL, SO LEFT OR RIGHT MUST BE ORDERED FOR EACH APPLICATION.

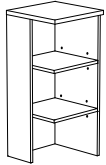

388-3616HSCSL

**HUTCH SQUARE CORNER SHELF**

FOR LEFT END APPLICATIONS

MATCHES 36" HUTCH OR 65" CABINET HEIGHTS. W/ 2 ADJUSTABLE SHELVES.

**388-3616HSCSL**     **\$487**     **\$555**     **65**     **1.2**     **16**     **16**     **35.5**     **35**

MATCHES 43" HUTCH OR 72" CABINET HEIGHTS. W/ 2 ADJUSTABLE SHELVES.

**388-4316HSCSL**     **\$534**     **\$609**     **72**     **1.8**     **16**     **16**     **42.5**     **42**

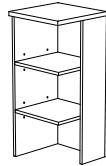

388-3616HSCSR

FOR RIGHT END APPLICATION

MATCHES 36" HUTCH OR 65" CABINET HEIGHTS. W/ 2 ADJUSTABLE SHELVES.

**388-3616HSCSR**     **\$487**     **\$555**     **65**     **1.2**     **16**     **16**     **35.5**     **35**

MATCHES 43" HUTCH OR 72" CABINET HEIGHTS. W/ 2 ADJUSTABLE SHELVES.

**388-4316HSCSR**     **\$534**     **\$609**     **72**     **1.8**     **16**     **16**     **42.5**     **42**

**RTA**

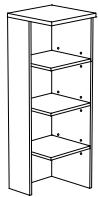

388-4816HSCSL

**DOUBLE HIGH HUTCH SQUARE CORNER SHELF**

FOR LEFT END APPLICATIONS

MATCHES 48" HUTCH OR 77" CABINET HEIGHTS. 3 ADJUSTABLE SHELVES.

**388-4816HSCSL**     **\$600**     **\$684**     **82**     **2**     **16**     **16**     **47.25**     **46.75**

MATCHES 55" HUTCH OR 84" CABINET HEIGHTS. 3 ADJUSTABLE SHELVES.

**388-5516HSCSL**     **\$731**     **\$833**     **98**     **2.7**     **16**     **16**     **54.25**     **53.75**

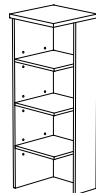

388-4816HSCSR

FOR RIGHT END APPLICATION

MATCHES 48" HUTCH OR 77" CABINET HEIGHTS. 3 ADJUSTABLE SHELVES.

**388-4816HSCSR**     **\$600**     **\$684**     **82**     **2**     **16**     **16**     **47.25**     **46.75**

MATCHES 55" HUTCH OR 84" CABINET HEIGHTS. 3 ADJUSTABLE SHELVES.

**388-5516HSCSR**     **\$731**     **\$833**     **98**     **2.7**     **16**     **16**     **54.25**     **53.75**

**RTA**

# 388/600 SQUARE CORNER SHELVES

| MODEL | 388  |      | 600  |                 | WEIGHT | CUBE | W | D | 388 |    | 600 |     |
|-------|------|------|------|-----------------|--------|------|---|---|-----|----|-----|-----|
|       | LIST | LIST | LIST | LIST            |        |      |   |   | H   | H  |     |     |
|       | 1"   | 1½"  | LBS  | FT <sup>3</sup> |        |      |   |   | IN  | IN | 1"  | 1½" |

(IF ORDERED WITH A GRAINED FINISH) CORNER SHELVES ARE DESIGNED TO HAVE THE GRAIN RUN PARALLEL TO THE WALL, SO LEFT OR RIGHT MUST BE ORDERED FOR EACH APPLICATION.

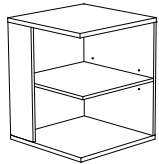

388-2924SCSL

RTA

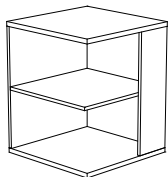

388-2924SCSR

## SQUARE CORNER SHELVES

FOR LEFT END APPLICATIONS  
1 ADJUSTABLE SHELF

|              |       |       |    |     |       |       |    |      |
|--------------|-------|-------|----|-----|-------|-------|----|------|
| 388-2920SCSL | \$525 | \$599 | 51 | 3   | 19.75 | 19.75 | 29 | 29.5 |
| 388-2924SCSL | \$585 | \$667 | 65 | 3.2 | 23.75 | 23.75 | 29 | 29.5 |
| 388-2930SCSL | \$615 | \$701 | 51 | 3.3 | 29.5  | 29.5  | 29 | 29.5 |

FOR RIGHT END APPLICATION  
1 ADJUSTABLE SHELF

|              |       |       |    |     |       |       |    |      |
|--------------|-------|-------|----|-----|-------|-------|----|------|
| 388-2920SCSR | \$525 | \$599 | 65 | 3   | 19.75 | 19.75 | 29 | 29.5 |
| 388-2924SCSR | \$585 | \$667 | 54 | 3.2 | 23.75 | 23.75 | 29 | 29.5 |
| 388-2930SCSR | \$615 | \$701 | 68 | 3.3 | 29.5  | 29.5  | 29 | 29.5 |

## FREESTANDING SQUARE CORNER SHELVES

FOR LEFT END APPLICATIONS  
4 ADJUSTABLE SHELVES.

|              |         |         |     |     |       |       |      |      |
|--------------|---------|---------|-----|-----|-------|-------|------|------|
| 388-6520SCSL | \$871   | \$993   | 154 | 5   | 19.5  | 19.5  | 64.5 | 64.5 |
| 388-6524SCSL | \$1,012 | \$1,154 | 170 | 6   | 23.75 | 23.75 | 64.5 | 64.5 |
| 388-7220SCSL | \$1,024 | \$1,167 | 163 | 6.1 | 19.5  | 19.5  | 71.5 | 71.5 |
| 388-7224SCSL | \$1,100 | \$1,254 | 180 | 6.5 | 23.75 | 23.75 | 71.5 | 71.5 |

5 ADJUSTABLE SHELVES.

|              |         |         |     |     |       |       |       |       |
|--------------|---------|---------|-----|-----|-------|-------|-------|-------|
| 388-7720SCSL | \$1,055 | \$1,203 | 177 | 6.1 | 19.75 | 19.75 | 76.25 | 76.25 |
| 388-7724SCSL | \$1,152 | \$1,313 | 191 | 6.9 | 23.75 | 23.75 | 76.25 | 76.25 |
| 388-8420SCSL | \$1,193 | \$1,360 | 192 | 7.5 | 19.75 | 19.75 | 83.25 | 83.25 |
| 388-8424SCSL | \$1,290 | \$1,471 | 204 | 8   | 23.75 | 23.75 | 83.25 | 83.25 |

FOR RIGHT END APPLICATION  
4 ADJUSTABLE SHELVES.

|              |         |         |     |     |       |       |      |      |
|--------------|---------|---------|-----|-----|-------|-------|------|------|
| 388-6520SCSR | \$871   | \$993   | 154 | 5   | 19.5  | 19.5  | 64.5 | 64.5 |
| 388-6524SCSR | \$1,012 | \$1,154 | 170 | 6   | 23.75 | 23.75 | 64.5 | 64.5 |
| 388-7220SCSR | \$1,024 | \$1,167 | 163 | 6.1 | 19.5  | 19.5  | 71.5 | 71.5 |
| 388-7224SCSR | \$1,100 | \$1,254 | 180 | 6.5 | 23.75 | 23.75 | 71.5 | 71.5 |

5 ADJUSTABLE SHELVES.

|              |         |         |     |     |       |       |       |       |
|--------------|---------|---------|-----|-----|-------|-------|-------|-------|
| 388-7720SCSR | \$1,055 | \$1,203 | 177 | 6.1 | 19.75 | 19.75 | 76.25 | 76.25 |
| 388-7724SCSR | \$1,152 | \$1,313 | 191 | 6.9 | 23.75 | 23.75 | 76.25 | 76.25 |
| 388-8420SCSR | \$1,193 | \$1,360 | 192 | 7.5 | 19.75 | 19.75 | 83.25 | 83.25 |
| 388-8424SCSR | \$1,290 | \$1,471 | 204 | 8   | 23.75 | 23.75 | 83.25 | 83.25 |

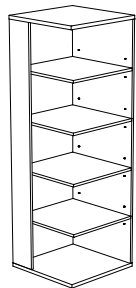

388-7224SCSL

RTA

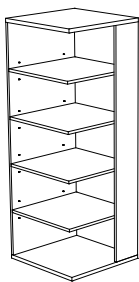

388-7224SCSR

RTA

|       | 388  | 600  |        |                 |    |    | 388 | 600 |
|-------|------|------|--------|-----------------|----|----|-----|-----|
| MODEL | LIST | LIST | WEIGHT | CUBE            | W  | D  | H   | H   |
|       | 1"   | 1½"  | LBS    | FT <sup>3</sup> | IN | IN | 1"  | 1½" |

(IF ORDERED WITH A GRAINED FINISH) CORNER SHELVES ARE DESIGNED TO HAVE THE GRAIN RUN PARALLEL TO THE WALL, SO LEFT OR RIGHT MUST BE ORDERED FOR EACH APPLICATION.

**HUTCH CORNER SHELF**

FOR LEFT END APPLICATIONS  
MATCHES 36" HUTCH OR 65" CABINET HEIGHTS. 2 ADJUSTABLE SHELVES.

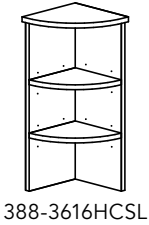

388-3616HCSL

**RTA**

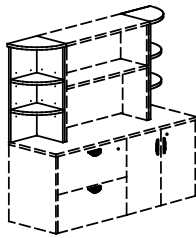

|                     |              |              |           |          |           |           |             |           |
|---------------------|--------------|--------------|-----------|----------|-----------|-----------|-------------|-----------|
| <b>388-3616HCSL</b> | <b>\$514</b> | <b>\$586</b> | <b>60</b> | <b>1</b> | <b>16</b> | <b>16</b> | <b>35.5</b> | <b>35</b> |
|---------------------|--------------|--------------|-----------|----------|-----------|-----------|-------------|-----------|

MATCHES 43" HUTCH OR 72" CABINET HEIGHTS. 2 ADJUSTABLE SHELVES.

|                     |              |              |           |            |           |           |             |           |
|---------------------|--------------|--------------|-----------|------------|-----------|-----------|-------------|-----------|
| <b>388-4316HCSL</b> | <b>\$616</b> | <b>\$702</b> | <b>70</b> | <b>1.5</b> | <b>16</b> | <b>16</b> | <b>42.5</b> | <b>42</b> |
|---------------------|--------------|--------------|-----------|------------|-----------|-----------|-------------|-----------|

FOR RIGHT END APPLICATION  
MATCHES 36" HUTCH OR 65" CABINET HEIGHTS. 2 ADJUSTABLE SHELVES.

|                     |              |              |           |          |           |           |             |           |
|---------------------|--------------|--------------|-----------|----------|-----------|-----------|-------------|-----------|
| <b>388-3616HCSR</b> | <b>\$514</b> | <b>\$586</b> | <b>60</b> | <b>1</b> | <b>16</b> | <b>16</b> | <b>35.5</b> | <b>35</b> |
|---------------------|--------------|--------------|-----------|----------|-----------|-----------|-------------|-----------|

MATCHES 43" HUTCH OR 72" CABINET HEIGHTS. 2 ADJUSTABLE SHELVES.

|                     |              |              |           |            |           |           |             |           |
|---------------------|--------------|--------------|-----------|------------|-----------|-----------|-------------|-----------|
| <b>388-4316HCSR</b> | <b>\$616</b> | <b>\$702</b> | <b>70</b> | <b>1.5</b> | <b>16</b> | <b>16</b> | <b>42.5</b> | <b>42</b> |
|---------------------|--------------|--------------|-----------|------------|-----------|-----------|-------------|-----------|

**DOUBLE HIGH HUTCH CORNER SHELF**

FOR LEFT END APPLICATIONS  
MATCHES 48" HUTCH OR 77" CABINET HEIGHTS. 3 ADJUSTABLE SHELVES.

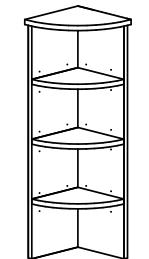

388-4816HCSL

**RTA**

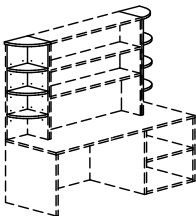

|                     |              |              |           |          |           |           |              |              |
|---------------------|--------------|--------------|-----------|----------|-----------|-----------|--------------|--------------|
| <b>388-4816HCSL</b> | <b>\$799</b> | <b>\$911</b> | <b>80</b> | <b>2</b> | <b>16</b> | <b>16</b> | <b>47.25</b> | <b>46.75</b> |
|---------------------|--------------|--------------|-----------|----------|-----------|-----------|--------------|--------------|

MATCHES 55" HUTCH OR 84" CABINET HEIGHTS. 3 ADJUSTABLE SHELVES.

|                     |              |              |           |          |           |           |              |              |
|---------------------|--------------|--------------|-----------|----------|-----------|-----------|--------------|--------------|
| <b>388-5516HCSL</b> | <b>\$826</b> | <b>\$942</b> | <b>53</b> | <b>2</b> | <b>16</b> | <b>16</b> | <b>54.25</b> | <b>53.75</b> |
|---------------------|--------------|--------------|-----------|----------|-----------|-----------|--------------|--------------|

FOR RIGHT END APPLICATION  
MATCHES 48" HUTCH OR 77" CABINET HEIGHTS. 3 ADJUSTABLE SHELVES.

|                     |              |              |           |          |           |           |              |              |
|---------------------|--------------|--------------|-----------|----------|-----------|-----------|--------------|--------------|
| <b>388-4816HCSR</b> | <b>\$799</b> | <b>\$911</b> | <b>80</b> | <b>2</b> | <b>16</b> | <b>16</b> | <b>47.25</b> | <b>46.75</b> |
|---------------------|--------------|--------------|-----------|----------|-----------|-----------|--------------|--------------|

MATCHES 55" HUTCH OR 84" CABINET HEIGHTS. 3 ADJUSTABLE SHELVES.

|                     |              |              |           |          |           |           |              |              |
|---------------------|--------------|--------------|-----------|----------|-----------|-----------|--------------|--------------|
| <b>388-5516HCSR</b> | <b>\$826</b> | <b>\$942</b> | <b>53</b> | <b>2</b> | <b>16</b> | <b>16</b> | <b>54.25</b> | <b>53.75</b> |
|---------------------|--------------|--------------|-----------|----------|-----------|-----------|--------------|--------------|

**CORNER SHELF**

WORKSURFACE HEIGHT FOR LEFT END APPLICATIONS  
1 ADJUSTABLE SHELF

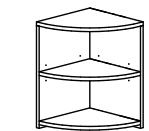

388-2924CSL

|                    |              |              |           |            |              |              |           |             |
|--------------------|--------------|--------------|-----------|------------|--------------|--------------|-----------|-------------|
| <b>388-2920CSL</b> | <b>\$514</b> | <b>\$586</b> | <b>62</b> | <b>1.5</b> | <b>19.75</b> | <b>19.75</b> | <b>29</b> | <b>29.5</b> |
|--------------------|--------------|--------------|-----------|------------|--------------|--------------|-----------|-------------|

|                    |              |              |           |          |              |              |           |             |
|--------------------|--------------|--------------|-----------|----------|--------------|--------------|-----------|-------------|
| <b>388-2924CSL</b> | <b>\$607</b> | <b>\$692</b> | <b>74</b> | <b>2</b> | <b>23.75</b> | <b>23.75</b> | <b>29</b> | <b>29.5</b> |
|--------------------|--------------|--------------|-----------|----------|--------------|--------------|-----------|-------------|

|                    |              |              |           |            |             |             |           |             |
|--------------------|--------------|--------------|-----------|------------|-------------|-------------|-----------|-------------|
| <b>388-2930CSL</b> | <b>\$675</b> | <b>\$770</b> | <b>86</b> | <b>2.4</b> | <b>29.5</b> | <b>29.5</b> | <b>29</b> | <b>29.5</b> |
|--------------------|--------------|--------------|-----------|------------|-------------|-------------|-----------|-------------|

WORKSURFACE HEIGHT FOR RIGHT END APPLICATIONS  
1 ADJUSTABLE SHELF

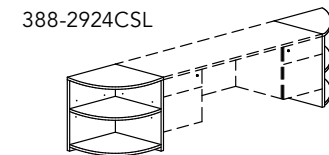

**RTA**

|                    |              |              |           |            |              |              |           |             |
|--------------------|--------------|--------------|-----------|------------|--------------|--------------|-----------|-------------|
| <b>388-2920CSR</b> | <b>\$514</b> | <b>\$586</b> | <b>62</b> | <b>1.5</b> | <b>19.75</b> | <b>19.75</b> | <b>29</b> | <b>29.5</b> |
|--------------------|--------------|--------------|-----------|------------|--------------|--------------|-----------|-------------|

|                    |              |              |           |          |              |              |           |             |
|--------------------|--------------|--------------|-----------|----------|--------------|--------------|-----------|-------------|
| <b>388-2924CSR</b> | <b>\$607</b> | <b>\$692</b> | <b>74</b> | <b>2</b> | <b>23.75</b> | <b>23.75</b> | <b>29</b> | <b>29.5</b> |
|--------------------|--------------|--------------|-----------|----------|--------------|--------------|-----------|-------------|

|                    |              |              |           |            |             |             |           |             |
|--------------------|--------------|--------------|-----------|------------|-------------|-------------|-----------|-------------|
| <b>388-2930CSR</b> | <b>\$675</b> | <b>\$770</b> | <b>86</b> | <b>2.4</b> | <b>29.5</b> | <b>29.5</b> | <b>29</b> | <b>29.5</b> |
|--------------------|--------------|--------------|-----------|------------|-------------|-------------|-----------|-------------|

# 388/600 CORNER SHELVES

| MODEL | 388  | 600  | WEIGHT | CUBE | W | D | 388 | 600 |
|-------|------|------|--------|------|---|---|-----|-----|
|       | LIST | LIST |        |      |   |   | H   | H   |
|       | 1"   | 1½"  |        |      |   |   | 1"  | 1½" |

### FREESTANDING CORNER SHELF

FOR LEFT END APPLICATIONS  
4 ADJUSTABLE SHELVES.

|             |         |         |     |     |       |       |      |      |
|-------------|---------|---------|-----|-----|-------|-------|------|------|
| 388-6520CSL | \$871   | \$993   | 122 | 3.5 | 19.75 | 19.75 | 64.5 | 64.5 |
| 388-6524CSL | \$1,057 | \$1,205 | 127 | 3.5 | 23.75 | 23.75 | 64.5 | 64.5 |
| 388-7220CSL | \$1,072 | \$1,222 | 130 | 4   | 19.75 | 19.75 | 71.5 | 71.5 |
| 388-7224CSL | \$1,093 | \$1,246 | 150 | 5   | 23.75 | 23.75 | 71.5 | 71.5 |

5 ADJUSTABLE SHELVES.

|             |         |         |     |     |       |       |       |       |
|-------------|---------|---------|-----|-----|-------|-------|-------|-------|
| 388-7720CSL | \$1,105 | \$1,260 | 145 | 5   | 19.75 | 19.75 | 76.25 | 76.25 |
| 388-7724CSL | \$1,128 | \$1,286 | 158 | 5.5 | 23.75 | 23.75 | 76.25 | 76.25 |
| 388-8420CSL | \$1,242 | \$1,416 | 153 | 6   | 19.75 | 19.75 | 83.25 | 83.25 |
| 388-8424CSL | \$1,264 | \$1,441 | 169 | 6.5 | 23.75 | 23.75 | 83.25 | 83.25 |

FOR RIGHT END APPLICATIONS  
4 ADJUSTABLE SHELVES.

|             |         |         |     |     |       |       |      |      |
|-------------|---------|---------|-----|-----|-------|-------|------|------|
| 388-6520CSR | \$871   | \$993   | 122 | 3.5 | 19.75 | 19.75 | 64.5 | 64.5 |
| 388-6524CSR | \$1,057 | \$1,205 | 127 | 3.5 | 23.75 | 23.75 | 64.5 | 64.5 |
| 388-7220CSR | \$1,072 | \$1,222 | 130 | 4   | 19.75 | 19.75 | 71.5 | 71.5 |
| 388-7224CSR | \$1,093 | \$1,246 | 150 | 5   | 23.75 | 23.75 | 71.5 | 71.5 |

5 ADJUSTABLE SHELVES.

|             |         |         |     |     |       |       |       |       |
|-------------|---------|---------|-----|-----|-------|-------|-------|-------|
| 388-7720CSR | \$1,105 | \$1,260 | 145 | 5   | 19.75 | 19.75 | 76.25 | 76.25 |
| 388-7724CSR | \$1,128 | \$1,286 | 158 | 5.5 | 23.75 | 23.75 | 76.25 | 76.25 |
| 388-8420CSR | \$1,242 | \$1,416 | 153 | 6   | 19.75 | 19.75 | 83.25 | 83.25 |
| 388-8424CSR | \$1,264 | \$1,441 | 169 | 6.5 | 23.75 | 23.75 | 83.25 | 83.25 |

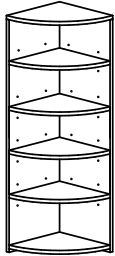

388-6520CSL

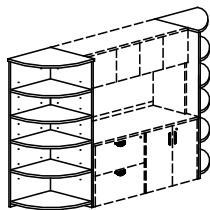

RTA

### OVERHEAD STORAGE CORNER SHELF

FOR LEFT END APPLICATIONS

|              |       |       |    |   |    |    |      |    |
|--------------|-------|-------|----|---|----|----|------|----|
| 388-1816OCSL | \$444 | \$506 | 30 | 1 | 16 | 16 | 17.5 | 18 |
|--------------|-------|-------|----|---|----|----|------|----|

FOR RIGHT END APPLICATIONS

|              |       |       |    |   |    |    |      |    |
|--------------|-------|-------|----|---|----|----|------|----|
| 388-1816OCSR | \$444 | \$506 | 30 | 1 | 16 | 16 | 17.5 | 18 |
|--------------|-------|-------|----|---|----|----|------|----|

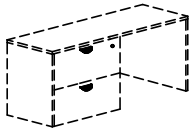
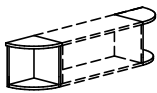
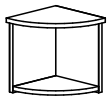

RTA

### DOUBLE HIGH OVERHEAD STORAGE CORNER SHELF

FOR LEFT END APPLICATIONS

1 ADJUSTABLE SHELF

|              |       |       |    |   |    |    |      |    |
|--------------|-------|-------|----|---|----|----|------|----|
| 388-3016OCSL | \$488 | \$556 | 50 | 1 | 16 | 16 | 29.5 | 30 |
|--------------|-------|-------|----|---|----|----|------|----|

FOR RIGHT END APPLICATIONS

1 ADJUSTABLE SHELF

|              |       |       |    |   |    |    |      |    |
|--------------|-------|-------|----|---|----|----|------|----|
| 388-3016OCSR | \$488 | \$556 | 50 | 1 | 16 | 16 | 29.5 | 30 |
|--------------|-------|-------|----|---|----|----|------|----|

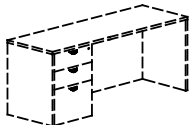
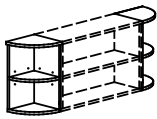
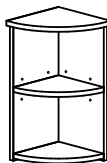

RTA

| MODEL | 388  | 600  | WEIGHT | CUBE | W | D | 388 | 600 |
|-------|------|------|--------|------|---|---|-----|-----|
|       | LIST | LIST |        |      |   |   | H   | H   |
|       | 1"   | 1½"  |        |      |   |   | 1"  | 1½" |

**TRANSACTION SHELVES**

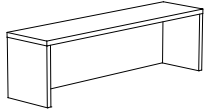

388-1448TA

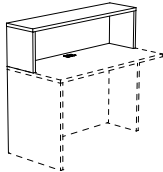

**RTA**

|            |       |       |    |     |       |    |    |    |
|------------|-------|-------|----|-----|-------|----|----|----|
| 388-1430TA | \$428 | \$488 | 32 | 0.8 | 29.5  | 12 | 14 | 14 |
| 388-1436TA | \$428 | \$488 | 34 | 0.9 | 35.5  | 12 | 14 | 14 |
| 388-1442TA | \$428 | \$488 | 37 | 1.1 | 41.5  | 12 | 14 | 14 |
| 388-1448TA | \$428 | \$488 | 40 | 1.2 | 47.25 | 12 | 14 | 14 |
| 388-1454TA | \$479 | \$546 | 44 | 1.4 | 53.25 | 12 | 14 | 14 |
| 388-1460TA | \$479 | \$546 | 46 | 1.5 | 59.25 | 12 | 14 | 14 |
| 388-1466TA | \$544 | \$620 | 52 | 1.7 | 65    | 12 | 14 | 14 |
| 388-1472TA | \$544 | \$620 | 58 | 1.8 | 71    | 12 | 14 | 14 |

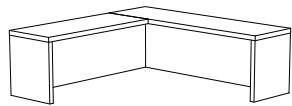

388-1442CTA

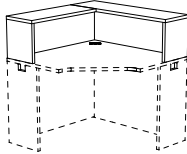

**RTA**

**CORNER TRANSACTION SHELVES**

|             |       |       |    |     |                 |    |    |    |
|-------------|-------|-------|----|-----|-----------------|----|----|----|
| 388-1436CTA | \$527 | \$601 | 46 | 1.2 | 35.5/<br>35.5   | 12 | 14 | 14 |
| 388-1442CTA | \$571 | \$651 | 53 | 1.4 | 41.5/<br>41.5   | 12 | 14 | 14 |
| 388-1448CTA | \$621 | \$708 | 60 | 1.6 | 47.25/<br>47.25 | 12 | 14 | 14 |

**EXAMPLE 1:**  
388-1442CTA  
388-4272CM  
388-1830DTO  
388-4204HC  
388-1918DCRH  
388-2442CT-B

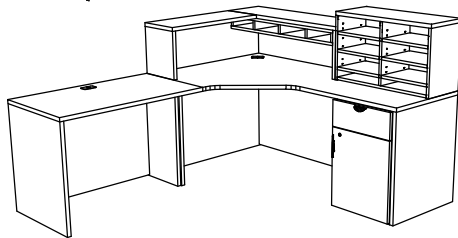

**EXAMPLE 2:**  
388-4204HC  
388-2442CT388-1442CTA  
388-4272CM  
388-1918DCRH  
388-1830DTO

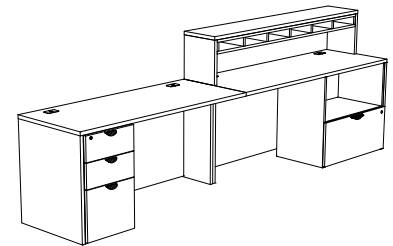

**388/600 GALLERY SHELLS**

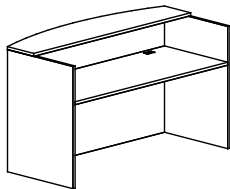

**RTA**

**GALLERY RECEPTION DESK SHELL**

|             |         |         |     |   |    |      |    |      |
|-------------|---------|---------|-----|---|----|------|----|------|
| 388-G3672DS | \$1,841 | \$2,099 | 255 | 7 | 71 | 35.5 | 43 | 43.5 |
|-------------|---------|---------|-----|---|----|------|----|------|

• RETURN MUST BE ORDERED SEPARATELY, SEE BELOW

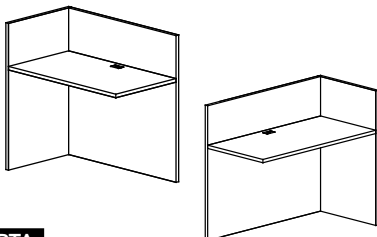

**RTA**

**GALLERY RETURN SHELL - NON HANDED**

|             |       |         |     |     |       |       |    |    |
|-------------|-------|---------|-----|-----|-------|-------|----|----|
| 388-G2442RS | \$880 | \$1,003 | 100 | 3   | 41.5  | 23.75 | 42 | 42 |
| 388-G2448RS | \$924 | \$1,053 | 110 | 3.8 | 47.25 | 23.75 | 42 | 42 |

|       | 388  |        |                 |    |    |    | 388 |
|-------|------|--------|-----------------|----|----|----|-----|
| MODEL | LIST | WEIGHT | CUBE            | W  | D  | H  |     |
|       | 1"   | LBS    | FT <sup>3</sup> | IN | IN | 1" |     |

♥ Default handles are Scoop Handles, available in Black (BL) & Silver (SL). See default handle/laminate finishes page [388/600-3](#). For handle substitutions see [388/600-5](#).

♥ Beds are commercial grade quality with steel frame and any HML laminate finish surrounding shell.

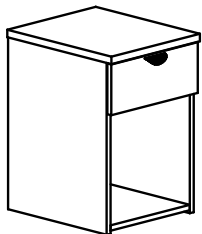
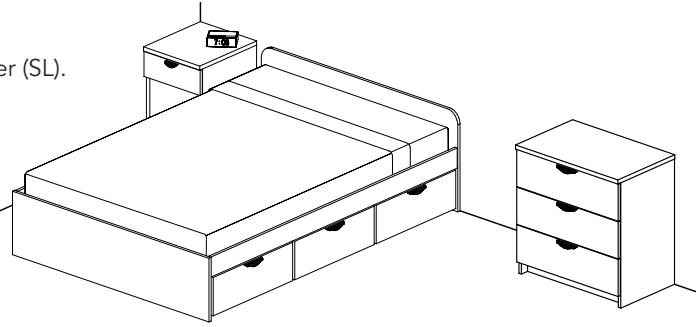

741-1916NS

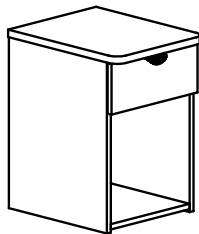

742-2016NS

**NIGHTSTAND**

|                   |              |    |     |    |       |      |
|-------------------|--------------|----|-----|----|-------|------|
| <b>741-1916NS</b> | <b>\$822</b> | 60 | 4.1 | 16 | 18.75 | 23.5 |
|-------------------|--------------|----|-----|----|-------|------|

- DEFAULT SMALL SCOOP HANDLE
- NON-LOCKING DRAWER

|                   |              |    |     |    |       |      |
|-------------------|--------------|----|-----|----|-------|------|
| <b>742-2016NS</b> | <b>\$872</b> | 63 | 4.3 | 16 | 19.75 | 23.5 |
|-------------------|--------------|----|-----|----|-------|------|

- RADIUSED FRONT TOP CORNERS
- DEFAULT SMALL SCOOP HANDLE
- NON-LOCKING DRAWER

**FULL CARTON**

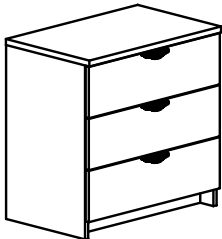

788-1930DR-3

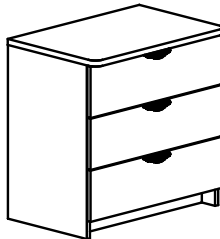

789-2030DR-3

**3 DRAWER DRESSER**

|                     |                |     |     |      |       |    |
|---------------------|----------------|-----|-----|------|-------|----|
| <b>788-1930DR-3</b> | <b>\$1,935</b> | 120 | 9.3 | 29.5 | 18.75 | 29 |
|---------------------|----------------|-----|-----|------|-------|----|

- DEFAULT LARGE SCOOP HANDLES
- NON-LOCKING DRAWERS

|                     |                |     |     |      |       |    |
|---------------------|----------------|-----|-----|------|-------|----|
| <b>789-2030DR-3</b> | <b>\$1,985</b> | 126 | 9.8 | 29.5 | 19.75 | 29 |
|---------------------|----------------|-----|-----|------|-------|----|

- RADIUSED FRONT TOP CORNERS
- DEFAULT LARGE SCOOP HANDLES
- NON-LOCKING DRAWERS

**FULL CARTON**

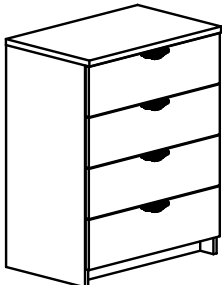

788-1930DR-4

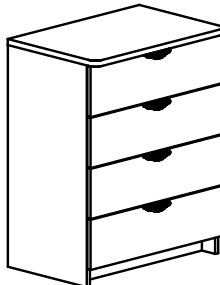

789-2030DR-4

**4 DRAWER DRESSER**

|                     |                |     |      |      |       |      |
|---------------------|----------------|-----|------|------|-------|------|
| <b>788-1930DR-4</b> | <b>\$2,173</b> | 156 | 12.1 | 29.5 | 18.75 | 37.5 |
|---------------------|----------------|-----|------|------|-------|------|

- DEFAULT LARGE SCOOP HANDLES
- NON-LOCKING DRAWERS

|                     |                |     |      |      |       |      |
|---------------------|----------------|-----|------|------|-------|------|
| <b>789-2030DR-4</b> | <b>\$2,223</b> | 163 | 12.6 | 29.5 | 19.75 | 37.5 |
|---------------------|----------------|-----|------|------|-------|------|

- RADIUSED FRONT TOP CORNERS
- DEFAULT LARGE SCOOP HANDLES
- NON-LOCKING DRAWERS

**FULL CARTON**

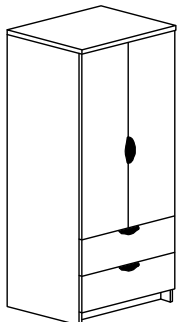

788-6530W2DR-24

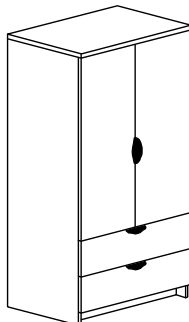

788-6536W2DR-24

**WARDROBE / 2 DRAWER DRESSER**

|                             |                |     |      |      |       |      |
|-----------------------------|----------------|-----|------|------|-------|------|
| <b>NEW!</b> 788-6530W2DR-24 | <b>\$2,025</b> | 206 | 26.2 | 29.5 | 23.75 | 64.5 |
|-----------------------------|----------------|-----|------|------|-------|------|

- DEFAULT SMALL SCOOP HANDLE
- NON-LOCKING DRAWERS

|                             |                |     |      |      |       |      |
|-----------------------------|----------------|-----|------|------|-------|------|
| <b>NEW!</b> 788-6536W2DR-24 | <b>\$2,145</b> | 232 | 31.5 | 35.5 | 23.75 | 64.5 |
|-----------------------------|----------------|-----|------|------|-------|------|

- DEFAULT SMALL SCOOP HANDLE
- NON-LOCKING DRAWERS

**FULL CARTON**

| MODEL | 388  |        |                 |    |    | 388 |
|-------|------|--------|-----------------|----|----|-----|
|       | LIST | WEIGHT | CUBE            | W  | D  | H   |
|       | 1"   | LBS    | FT <sup>3</sup> | IN | IN | 1"  |

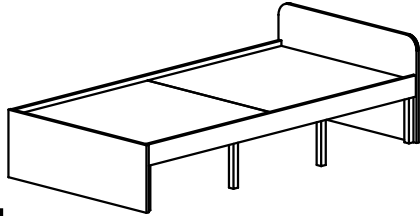

**RTA**

743-4081BD

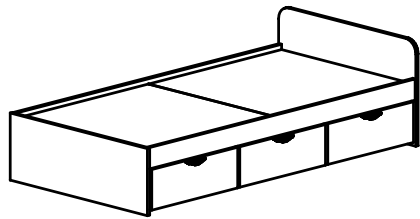

743-4081BD-DWR

**RTA**

(1X) 743-4081BD

**FULL CARTON**

(3X) DRAWERS

**TWIN BED**

FRAME ONLY

|                   |                |            |             |              |             |             |
|-------------------|----------------|------------|-------------|--------------|-------------|-------------|
| <b>743-4081BD</b> | <b>\$1,325</b> | <b>118</b> | <b>6.05</b> | <b>41.75</b> | <b>82.5</b> | <b>23.5</b> |
|-------------------|----------------|------------|-------------|--------------|-------------|-------------|

- MATTRESS NOT SOLD THROUGH HEARTWOOD - MUST BE SOURCED ELSEWHERE
- STEEL REINFORCED INTERNAL FRAME
- 40 X 81" BED DECK

FRAME WITH 3 MOBILE DRAWERS

|                       |                |            |             |              |             |             |
|-----------------------|----------------|------------|-------------|--------------|-------------|-------------|
| <b>743-4081BD-DWR</b> | <b>\$1,892</b> | <b>189</b> | <b>11.7</b> | <b>41.75</b> | <b>82.5</b> | <b>23.5</b> |
|-----------------------|----------------|------------|-------------|--------------|-------------|-------------|

- MATTRESS NOT SOLD THROUGH HEARTWOOD - MUST BE SOURCED ELSEWHERE
- STEEL REINFORCED INTERNAL FRAME
- THREE MOBILE DRAWERS
- 40 X 81" BED DECK

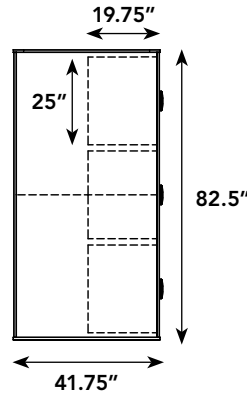

|          | W (IN) | L (IN) |
|----------|--------|--------|
| BED DECK | 40     | 81     |

|                  | W (IN) | L (IN) |   |
|------------------|--------|--------|---|
| TWIN             | 38     | 75*    | ✓ |
| TWIN (XL)        | 38     | 80     | ✓ |
| FULL/DOUBLE      | 54     | 75     | ✗ |
| FULL/DOUBLE (XL) | 54     | 80     | ✗ |
| QUEEN            | 60     | 80     | ✗ |

\* WILL RESULT IN A 6" GAP

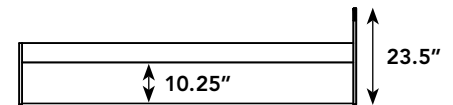

**FULL/DOUBLE BED**

FRAME ONLY

|                   |                |            |            |              |             |             |
|-------------------|----------------|------------|------------|--------------|-------------|-------------|
| <b>743-5581BD</b> | <b>\$1,431</b> | <b>151</b> | <b>8.2</b> | <b>56.75</b> | <b>82.5</b> | <b>23.5</b> |
|-------------------|----------------|------------|------------|--------------|-------------|-------------|

- MATTRESS NOT SOLD THROUGH HEARTWOOD - MUST BE SOURCED ELSEWHERE
- STEEL REINFORCED INTERNAL FRAME
- 55 X 81" BED DECK

FRAME WITH 3 MOBILE DRAWERS

|                       |                |            |             |              |             |             |
|-----------------------|----------------|------------|-------------|--------------|-------------|-------------|
| <b>743-5581BD-DWR</b> | <b>\$2,011</b> | <b>222</b> | <b>13.8</b> | <b>56.75</b> | <b>82.5</b> | <b>23.5</b> |
|-----------------------|----------------|------------|-------------|--------------|-------------|-------------|

- MATTRESS NOT SOLD THROUGH HEARTWOOD - MUST BE SOURCED ELSEWHERE
- STEEL REINFORCED INTERNAL FRAME
- THREE MOBILE DRAWERS
- 55 X 81" BED DECK

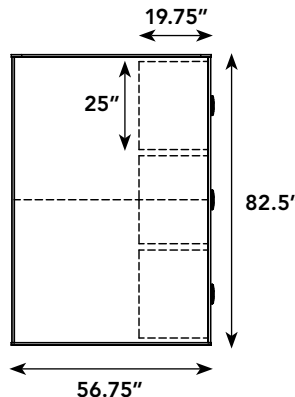

|          | W (IN) | L (IN) |
|----------|--------|--------|
| BED DECK | 55     | 81     |

|                  | W (IN) | L (IN) |   |
|------------------|--------|--------|---|
| TWIN             | 38     | 75     | ✗ |
| TWIN (XL)        | 38     | 80     | ✗ |
| FULL/DOUBLE      | 54     | 75*    | ✓ |
| FULL/DOUBLE (XL) | 54     | 80     | ✓ |
| QUEEN            | 60     | 80     | ✗ |

\* WILL RESULT IN A 6" GAP

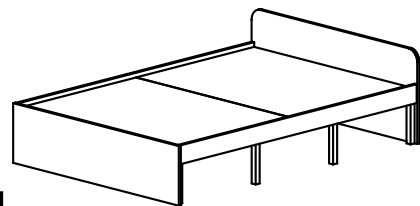
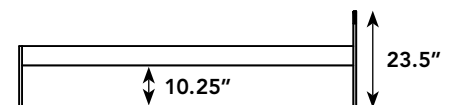

**RTA**

743-5581BD

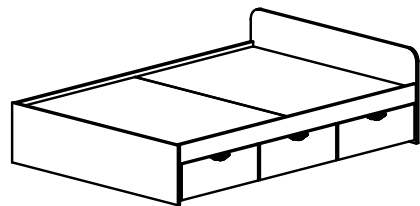

743-5581BD-DWR

**RTA**

(1X) 743-5581BD

**FULL CARTON**

(3X) DRAWERS

|  |       |      |        |                 |    |    |     |
|--|-------|------|--------|-----------------|----|----|-----|
|  |       |      |        |                 |    |    | 388 |
|  | MODEL | LIST | WEIGHT | CUBE            | W  | D  | H   |
|  |       | 1"   | LBS    | FT <sup>3</sup> | IN | IN | 1"  |

**TWIN BED**

**NEW!** FRAME ONLY

**744-3681BD-HF**      **\$680**      **63**      **9.4**      **38**      **83.25**      **35.5**

- MATTRESS NOT SOLD THROUGH HEARTWOOD - MUST BE SOURCED ELSEWHERE
- METAL HEADBOARD (H) AND FOOTBOARD (F)
- STEEL FRAME
- 40 X 81" BED DECK

**NEW!** FRAME ONLY WITH LAMINATE TRIM, INCLUDING SQUARE HEADBOARD

**745-3681SBD-HFR**      **\$950**      **104**      **10.3**      **38**      **83.25**      **35.5**

- MATTRESS NOT SOLD THROUGH HEARTWOOD - MUST BE SOURCED ELSEWHERE
- LAMINATE HEADBOARD (H), FOOTBOARD (F), AND RAILS (R)
- STEEL FRAME
- 40 X 81" BED DECK

**NEW!** FRAME ONLY WITH LAMINATE TRIM, INCLUDING RADIUS HEADBOARD

**745-3681BD-HFR**      **\$1,000**      **106**      **10.3**      **38**      **83.25**      **38.5**

- MATTRESS NOT SOLD THROUGH HEARTWOOD - MUST BE SOURCED ELSEWHERE
- LAMINATE HEADBOARD (H), FOOTBOARD (F), AND RAILS (R)
- STEEL FRAME
- 40 X 81" BED DECK

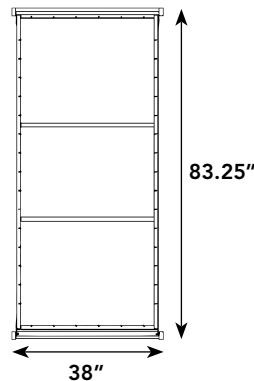
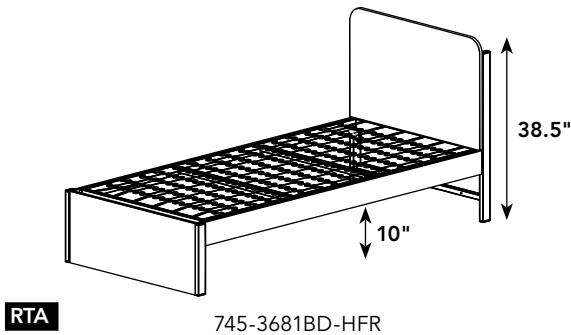
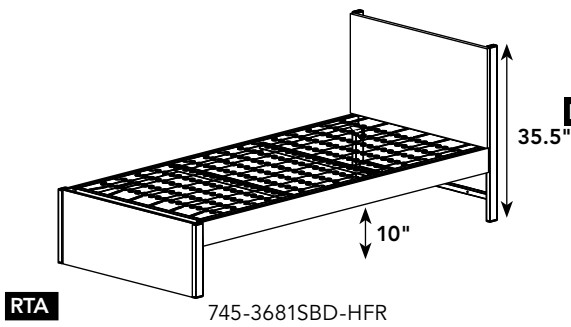
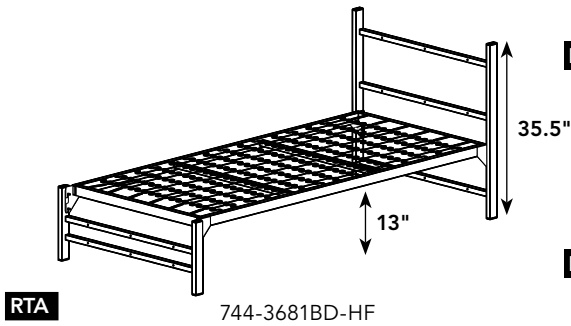

|                  | W (IN) | L (IN) |   |
|------------------|--------|--------|---|
| BED DECK         | 36     | 81     |   |
|                  | W (IN) | L (IN) |   |
| TWIN             | 38     | 75*    | ✓ |
| TWIN (XL)        | 38     | 80     | ✓ |
| FULL/DOUBLE      | 54     | 75     | ✗ |
| FULL/DOUBLE (XL) | 54     | 80     | ✗ |
| QUEEN            | 60     | 80     | ✗ |

\* WILL RESULT IN A 6" GAP

**NEW!** 1 DRAWER DRESSER

**744-1930DR**      **\$575**      **45**      **3.1**      **29.5**      **18.75**      **9.75**

- FITS UNDER 744- AND 745- BED FRAMES
- DEFAULT SMALL SCOOP HANDLE
- NON-LOCKING DRAWER

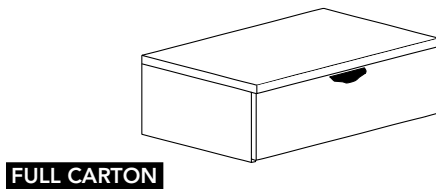

**EXAMPLES:**

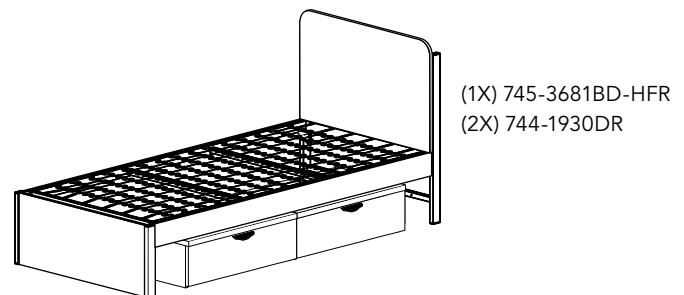
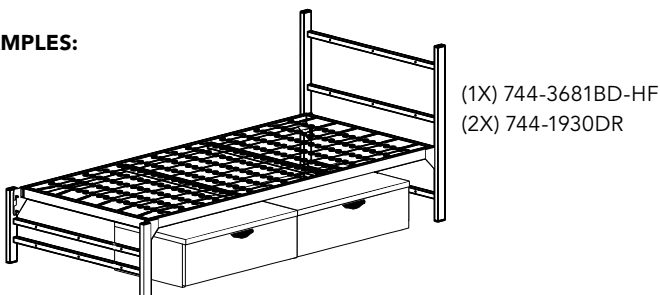



|       |      |            |                 |    |    |    |            |
|-------|------|------------|-----------------|----|----|----|------------|
|       |      | <b>388</b> |                 |    |    |    | <b>388</b> |
| MODEL | LIST | WEIGHT     | CUBE            | W  | D  | H  |            |
|       | 1"   | LBS        | FT <sup>3</sup> | IN | IN | 1" |            |

**FULL/DOUBLE BED**

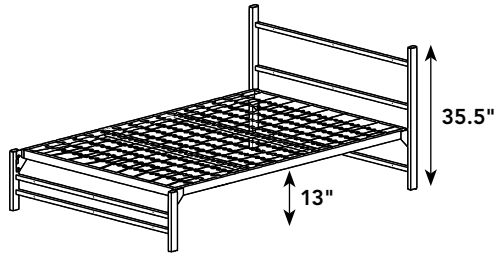

**RTA**

744-5381BD-HF

**NEW!** FRAME ONLY

**744-5381BD-HF**    **\$800**    **88**    **13.6**    **54.75**    **83.25**    **35.5**

- MATTRESS NOT SOLD THROUGH HEARTWOOD - MUST BE SOURCED ELSEWHERE
- METAL HEADBOARD (H) AND FOOTBOARD (F)
- STEEL FRAME
- 55 X 81" BED DECK

**NEW!** FRAME ONLY WITH LAMINATE TRIM, INCLUDING SQUARE HEADBOARD

**745-5381SBD-HFR**    **\$1,075**    **141**    **14.8**    **54.75**    **83.25**    **35.5**

- MATTRESS NOT SOLD THROUGH HEARTWOOD - MUST BE SOURCED ELSEWHERE
- LAMINATE HEADBOARD (H), FOOTBOARD (F), AND RAILS (R)
- STEEL FRAME
- 55 X 81" BED DECK

**NEW!** FRAME ONLY WITH LAMINATE TRIM, INCLUDING RADIUSSED HEADBOARD

**745-5381BD-HFR**    **\$1,125**    **144**    **14.9**    **54.75**    **83.25**    **38.5**

- MATTRESS NOT SOLD THROUGH HEARTWOOD - MUST BE SOURCED ELSEWHERE
- LAMINATE HEADBOARD (H), FOOTBOARD (F), AND RAILS (R)
- STEEL FRAME
- 55 X 81" BED DECK

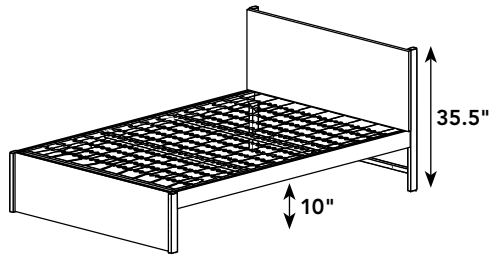

**RTA**

745-5381SBD-HFR

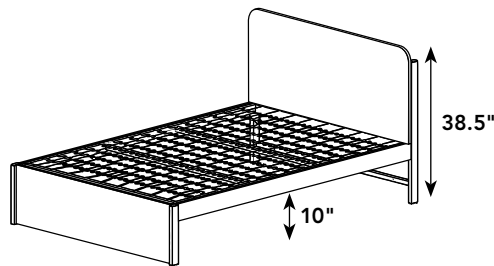

**RTA**

745-5381BD-HFR

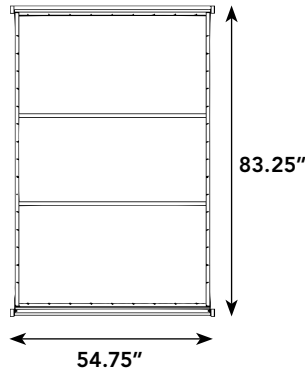

|                  | W (IN) | L (IN) |   |
|------------------|--------|--------|---|
| BED DECK         | 53     | 81     |   |
|                  | W (IN) | L (IN) |   |
| TWIN             | 38     | 75     | X |
| TWIN (XL)        | 38     | 80     | X |
| FULL/DOUBLE      | 54     | 75*    | ✓ |
| FULL/DOUBLE (XL) | 54     | 80     | ✓ |
| QUEEN            | 60     | 80     | X |

\* WILL RESULT IN A 6" GAP

**NEW!** 1 DRAWER DRESSER

**744-1930DR**    **\$575**    **45**    **3.1**    **29.5**    **18.75**    **9.75**

- FITS UNDER 744- AND 745- BED FRAMES
- DEFAULT SMALL SCOOP HANDLE
- NON-LOCKING DRAWER

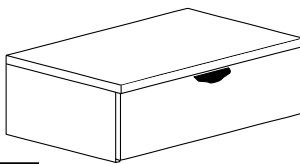

**FULL CARTON**

**EXAMPLES:**

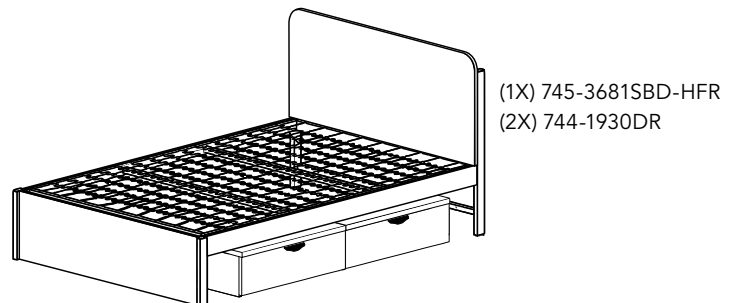
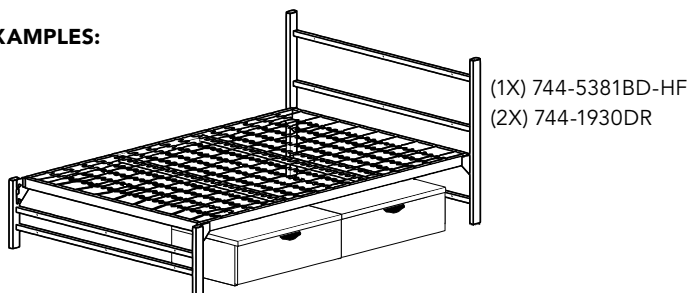

- ♥ All locker units come with locking door/s & unique locks per door. Electronic combination locks are an available add-on - see below.
- ♥ Default handles are Bar Handles, available in Black (BL) & Silver (SL). See default handle/laminate finishes page [388/600-3](#).  
For handle substitutions see [388/600-5](#)
- ♥ Lockers have toe kick design and leveling glides are standard
- ♥ Locker units ship full carton

**THE FOLLOWING ADD-ON FEATURES ARE AVAILABLE FOR OUR 388 SERIES LAMINATE LOCKERS**

| LOCKER OPTIONS  | UPCHARGE     | LOCKER OPTIONS   | UPCHARGE    |
|---|--------------|--|-------------|
| VENT IN BACKSIDE - ADD V TO SKU   | <b>\$64</b>  | <b>BOOT SHELF</b> - ADD TO DESCRIPTION   | <b>\$60</b> |
| <b>ELECTRONIC LOCK</b> - ADD EL TO SKU                                    | <b>\$148</b> | <ul style="list-style-type: none"> <li>• FIXED SHELF, CAVITY HEIGHT 12.25"</li> <li>• BOOT SHELVES ARE RECOMMENDED FOR 1 DOOR OR 2 DOOR WIDE UNITS, 1 DOOR TALL. FOR ADDITIONAL SIZES CONTACT CUSTOMER SERVICE.</li> </ul> |             |
| <b>NUMBER PLATE</b> - ADD NP TO SKU                                       | <b>\$37</b>  | <b>HAT SHELF</b> - ADD TO DESCRIPTION  | <b>\$60</b> |
| <b>COAT HOOKS</b> - ADD TO DESCRIPTION                                    | <b>\$28</b>  | <ul style="list-style-type: none"> <li>• FIXED SHELF, CAVITY HEIGHT 12.25"</li> <li>• HAT SHELVES ARE RECOMMENDED FOR 1 DOOR OR 2 DOOR WIDE UNITS, 1 DOOR TALL. FOR ADDITIONAL SIZES CONTACT CUSTOMER SERVICE.</li> </ul>  |             |
| <ul style="list-style-type: none"> <li>• 1 PER GABLE / DIVIDER</li> </ul> |              | <b>GANGING HARDWARE</b> - ADD TO DESCRIPTION   | <b>\$37</b> |
|   |              | <b>BOOT TRAY</b> - ADD TO DESCRIPTION  | <b>\$35</b> |

THE ABOVE FEATURE UPCHARGES ARE APPLIED PER CUBBY & PER UNIT. A SINGLE WIDE, 3 DOOR LOCKER HAS THREE CUBBIES & WHEN A FEATURE IS APPLIED, IT IS ADDED TO **ALL** CUBBIES.  
**ELECTRONIC LOCK:**  
 EXAMPLE LOC-6518CLH2-18-EL - 2 X **\$148**  
**VENT INTO BACKSIDE:**  
 EXAMPLE LOC-7218CRH3-18-V - 3 X **\$64**

**LAYOUT & SIZING EXAMPLE**

**SINGLE DOOR EXAMPLES**

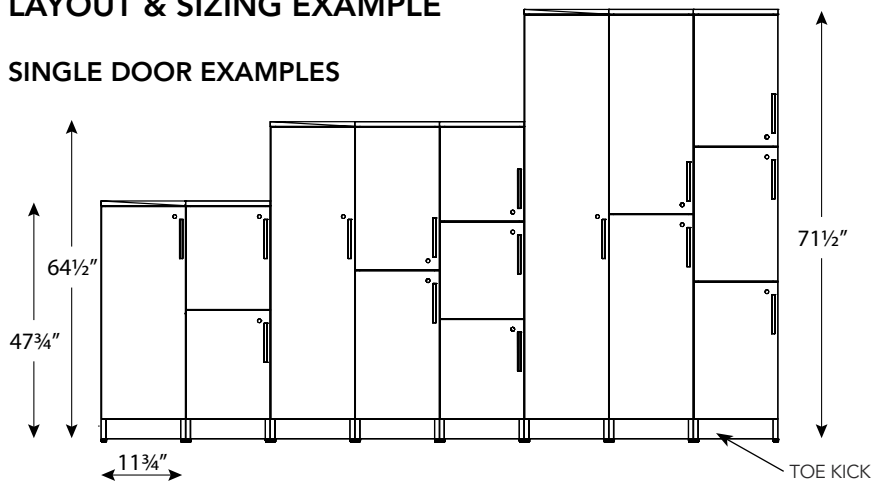

**DOUBLE DOOR EXAMPLES**

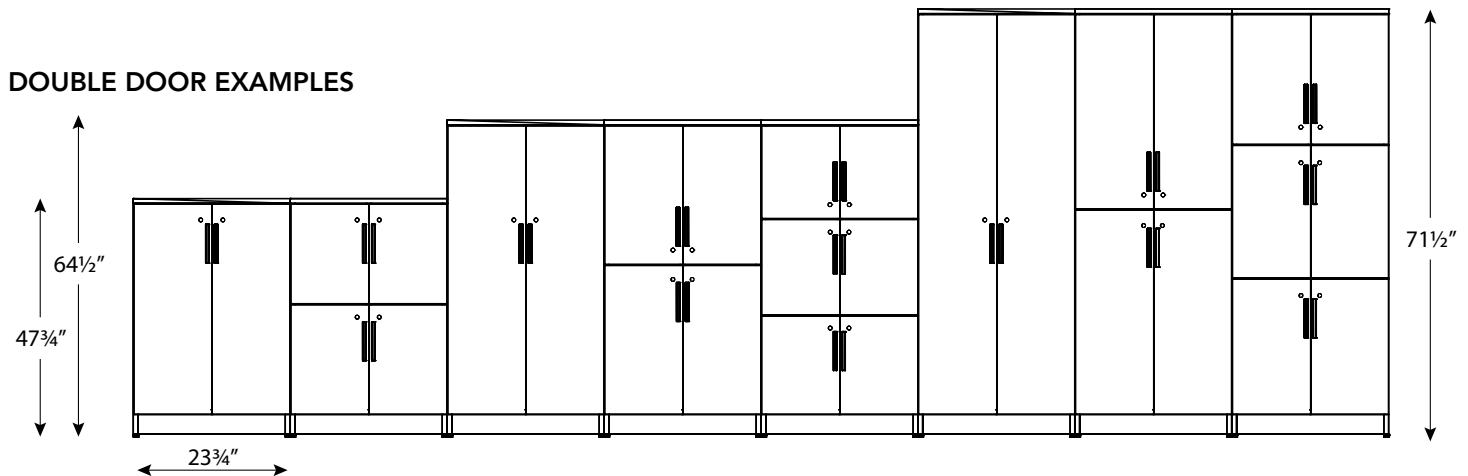

| MODEL | 388  |        |                 |    |    |    | 388 |
|-------|------|--------|-----------------|----|----|----|-----|
|       | LIST | WEIGHT | CUBE            | W  | D  | H  |     |
|       | 1"   | LBS    | FT <sup>3</sup> | IN | IN | 1" |     |

**48" TALL - 1 DOOR LOCKER**

LEFT HINGE, 1 SINGLE DOOR

|                 |         |      |      |       |       |       |
|-----------------|---------|------|------|-------|-------|-------|
| LOC-4812CLH1-18 | \$965   | 55   | 5.8  | 12    | 17.75 | 47.75 |
| LOC-4812CLH1-24 | \$1,058 | 67.6 | 7.8  | 12    | 23.75 | 47.75 |
| LOC-4818CLH1-18 | \$1,145 | 68.8 | 8.7  | 17.75 | 17.75 | 47.75 |
| LOC-4818CLH1-24 | \$1,270 | 82.7 | 11.6 | 17.75 | 23.75 | 47.75 |

RIGHT HINGE, 1 SINGLE DOOR

|                 |         |      |      |       |       |       |
|-----------------|---------|------|------|-------|-------|-------|
| LOC-4812CRH1-18 | \$965   | 55   | 5.8  | 12    | 17.75 | 47.75 |
| LOC-4812CRH1-24 | \$1,058 | 67.6 | 7.8  | 12    | 23.75 | 47.75 |
| LOC-4818CRH1-18 | \$1,145 | 68.8 | 8.7  | 17.75 | 17.75 | 47.75 |
| LOC-4818CRH1-24 | \$1,270 | 82.7 | 11.6 | 17.75 | 23.75 | 47.75 |

- LOCKING DOOR
- DEFAULT BAR HANDLE

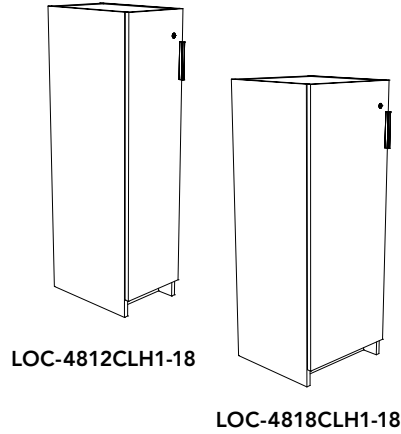

**48" TALL - 2 DOOR LOCKER**

LEFT HINGE, SINGLE WIDE 2 DOOR

|                 |         |      |      |       |       |       |
|-----------------|---------|------|------|-------|-------|-------|
| LOC-4812CLH2-18 | \$1,071 | 55   | 5.8  | 12    | 17.75 | 47.75 |
| LOC-4812CLH2-24 | \$1,164 | 67.6 | 7.8  | 12    | 23.75 | 47.75 |
| LOC-4818CLH2-18 | \$1,251 | 68.8 | 8.7  | 17.75 | 17.75 | 47.75 |
| LOC-4818CLH2-24 | \$1,376 | 82.7 | 11.6 | 17.75 | 23.75 | 47.75 |

RIGHT HINGE, SINGLE WIDE 2 DOOR

|                 |         |      |      |       |       |       |
|-----------------|---------|------|------|-------|-------|-------|
| LOC-4812CRH2-18 | \$1,071 | 55   | 5.8  | 12    | 17.75 | 47.75 |
| LOC-4812CRH2-24 | \$1,164 | 67.6 | 7.8  | 12    | 23.75 | 47.75 |
| LOC-4818CRH2-18 | \$1,251 | 68.8 | 8.7  | 17.75 | 17.75 | 47.75 |
| LOC-4818CRH2-24 | \$1,376 | 82.7 | 11.6 | 17.75 | 23.75 | 47.75 |

- ALL DOORS LOCK WITH UNIQUE LOCKS
- DEFAULT BAR HANDLES

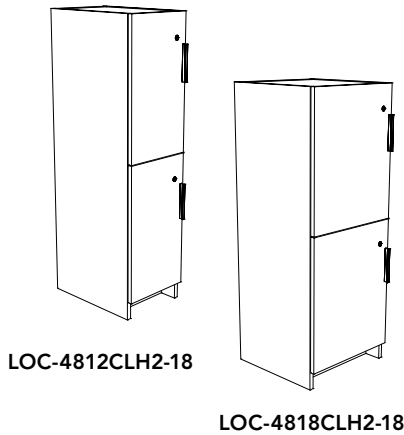

# 388/600 LOCKERS

## 48" HIGH

| MODEL | 388  |        | 388             |    |    |    |
|-------|------|--------|-----------------|----|----|----|
|       | LIST | WEIGHT | CUBE            | W  | D  | H  |
|       | 1"   | LBS    | FT <sup>3</sup> | IN | IN | 1" |

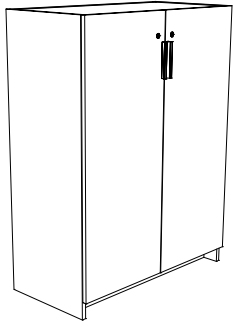

LOC-4836C2-18

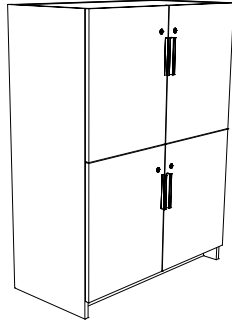

LOC-4836C4-18

### 48" TALL - 2 DOOR LOCKER

2 WIDE, SINGLE DOOR

|               |         |       |      |       |       |       |
|---------------|---------|-------|------|-------|-------|-------|
| LOC-4824C2-18 | \$1,158 | 82.6  | 11.6 | 23.75 | 17.75 | 47.75 |
| LOC-4824C2-24 | \$1,270 | 97.7  | 15.5 | 23.75 | 23.75 | 47.75 |
| LOC-4836C2-18 | \$1,293 | 110.2 | 17.4 | 35.5  | 17.75 | 47.75 |
| LOC-4836C2-24 | \$1,467 | 128   | 23.2 | 35.5  | 23.75 | 47.75 |

### 48" TALL - 4 DOOR LOCKER

2 WIDE, 2 DOOR

|               |         |       |      |       |       |       |
|---------------|---------|-------|------|-------|-------|-------|
| LOC-4824C4-18 | \$1,317 | 82.6  | 11.6 | 23.75 | 17.75 | 47.75 |
| LOC-4824C4-24 | \$1,429 | 97.7  | 15.5 | 23.75 | 23.75 | 47.75 |
| LOC-4836C4-18 | \$1,452 | 110.2 | 17.4 | 35.5  | 17.75 | 47.75 |
| LOC-4836C4-24 | \$1,626 | 128   | 23.2 | 35.5  | 23.75 | 47.75 |

- ALL DOORS LOCK WITH UNIQUE LOCKS
- DEFAULT BAR HANDLES

## 65" HIGH

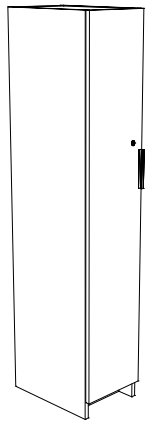

LOC-6512CLH1-18

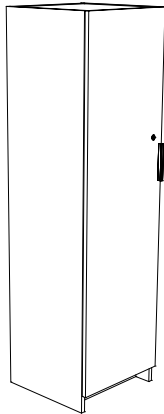

LOC-6518CLH1-18

### 65" TALL - 1 DOOR LOCKER

LEFT HINGE, 1 SINGLE DOOR

|                 |         |       |      |       |       |      |
|-----------------|---------|-------|------|-------|-------|------|
| LOC-6512CLH1-18 | \$1,431 | 72.3  | 7.9  | 12    | 17.75 | 64.5 |
| LOC-6512CLH1-24 | \$1,591 | 88.5  | 10.6 | 12    | 23.75 | 64.5 |
| LOC-6518CLH1-18 | \$1,558 | 89.8  | 11.7 | 17.75 | 17.75 | 64.5 |
| LOC-6518CLH1-24 | \$1,639 | 107.3 | 15.7 | 17.75 | 23.75 | 64.5 |

RIGHT HINGE, 1 SINGLE DOOR

|                 |         |       |      |       |       |      |
|-----------------|---------|-------|------|-------|-------|------|
| LOC-6512CRH1-18 | \$1,431 | 72.3  | 7.9  | 12    | 17.75 | 64.5 |
| LOC-6512CRH1-24 | \$1,591 | 88.5  | 10.6 | 12    | 23.75 | 64.5 |
| LOC-6518CRH1-18 | \$1,558 | 89.8  | 11.7 | 17.75 | 17.75 | 64.5 |
| LOC-6518CRH1-24 | \$1,639 | 107.3 | 15.7 | 17.75 | 23.75 | 64.5 |

- LOCKING DOOR
- DEFAULT BAR HANDLES

| MODEL | 388  |        |                 |    |    |    | 388 |
|-------|------|--------|-----------------|----|----|----|-----|
|       | LIST | WEIGHT | CUBE            | W  | D  | H  |     |
|       | 1"   | LBS    | FT <sup>3</sup> | IN | IN | 1" |     |

**65" TALL - 2 DOOR LOCKER**

LEFT HINGE, SINGLE WIDE 2 DOOR

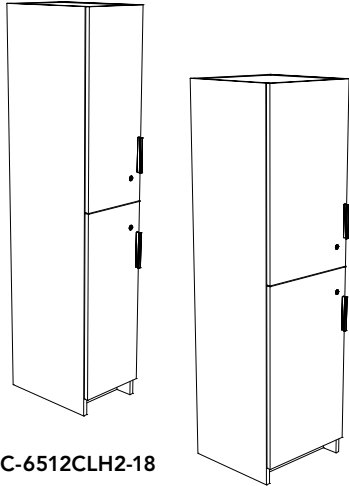

LOC-6512CLH2-18

LOC-6518CLH2-18

|                 |                |       |      |       |       |      |
|-----------------|----------------|-------|------|-------|-------|------|
| LOC-6512CLH2-18 | <b>\$1,537</b> | 72.3  | 7.9  | 12    | 17.75 | 64.5 |
| LOC-6512CLH2-24 | <b>\$1,697</b> | 88.5  | 10.6 | 12    | 23.75 | 64.5 |
| LOC-6518CLH2-18 | <b>\$1,664</b> | 89.8  | 11.7 | 17.75 | 17.75 | 64.5 |
| LOC-6518CLH2-24 | <b>\$1,745</b> | 107.3 | 15.7 | 17.75 | 23.75 | 64.5 |

RIGHT HINGE, SINGLE WIDE 2 DOOR

|                 |                |       |      |       |       |      |
|-----------------|----------------|-------|------|-------|-------|------|
| LOC-6512CRH2-18 | <b>\$1,537</b> | 72.3  | 7.9  | 12    | 17.75 | 64.5 |
| LOC-6512CRH2-24 | <b>\$1,697</b> | 88.5  | 10.6 | 12    | 23.75 | 64.5 |
| LOC-6518CRH2-18 | <b>\$1,664</b> | 89.8  | 11.7 | 17.75 | 17.75 | 64.5 |
| LOC-6518CRH2-24 | <b>\$1,745</b> | 107.3 | 15.7 | 17.75 | 23.75 | 64.5 |

- ALL DOORS LOCK WITH UNIQUE LOCKS
- DEFAULT BAR HANDLES

**65" TALL - 3 DOOR LOCKER**

LEFT HINGE, SINGLE WIDE 3 DOOR

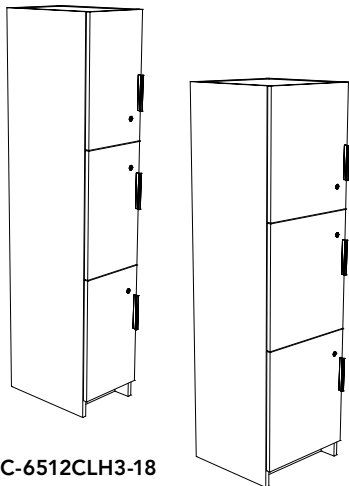

LOC-6512CLH3-18

LOC-6518CLH3-18

|                 |                |       |      |       |       |      |
|-----------------|----------------|-------|------|-------|-------|------|
| LOC-6512CLH3-18 | <b>\$1,643</b> | 72.3  | 7.9  | 12    | 17.75 | 64.5 |
| LOC-6512CLH3-24 | <b>\$1,803</b> | 88.5  | 10.6 | 12    | 23.75 | 64.5 |
| LOC-6518CLH3-18 | <b>\$1,770</b> | 89.8  | 11.7 | 17.75 | 17.75 | 64.5 |
| LOC-6518CLH3-24 | <b>\$1,851</b> | 107.3 | 15.7 | 17.75 | 23.75 | 64.5 |

RIGHT HINGE, SINGLE WIDE 3 DOOR

|                 |                |       |      |       |       |      |
|-----------------|----------------|-------|------|-------|-------|------|
| LOC-6512CRH3-18 | <b>\$1,643</b> | 72.3  | 7.9  | 12    | 17.75 | 64.5 |
| LOC-6512CRH3-24 | <b>\$1,803</b> | 88.5  | 10.6 | 12    | 23.75 | 64.5 |
| LOC-6518CRH3-18 | <b>\$1,770</b> | 89.8  | 11.7 | 17.75 | 17.75 | 64.5 |
| LOC-6518CRH3-24 | <b>\$1,851</b> | 107.3 | 15.7 | 17.75 | 23.75 | 64.5 |

- ALL DOORS LOCK WITH UNIQUE LOCKS
- DEFAULT BAR HANDLES

**388/600 LOCKERS**  
65" HIGH

|       | 388  |        |                 |    |    |    | 388 |
|-------|------|--------|-----------------|----|----|----|-----|
| MODEL | LIST | WEIGHT | CUBE            | W  | D  | H  |     |
|       | 1"   | LBS    | FT <sup>3</sup> | IN | IN | 1" |     |

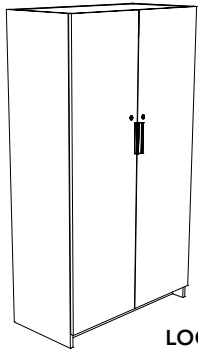

LOC-6536C2-18

**65" TALL - 2 DOOR LOCKER**

2 WIDE, SINGLE DOOR

|               |         |       |      |       |       |      |
|---------------|---------|-------|------|-------|-------|------|
| LOC-6524C2-18 | \$2,311 | 107.2 | 15.7 | 23.75 | 17.75 | 64.5 |
| LOC-6524C2-24 | \$2,435 | 126   | 21   | 23.75 | 23.75 | 64.5 |
| LOC-6536C2-18 | \$2,648 | 142.1 | 23.5 | 35.5  | 17.75 | 64.5 |
| LOC-6536C2-24 | \$2,846 | 163.5 | 31.4 | 35.5  | 23.75 | 64.5 |

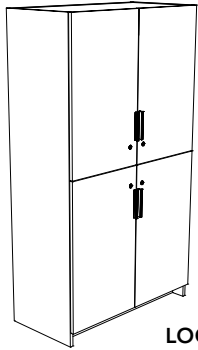

LOC-6536C4-18

**65" TALL - 4 DOOR LOCKER**

2 WIDE, 2 DOOR

|               |         |       |      |       |       |      |
|---------------|---------|-------|------|-------|-------|------|
| LOC-6524C4-18 | \$2,417 | 107.2 | 15.7 | 23.75 | 17.75 | 64.5 |
| LOC-6524C4-24 | \$2,541 | 126   | 21   | 23.75 | 23.75 | 64.5 |
| LOC-6536C4-18 | \$2,754 | 142.1 | 23.5 | 35.5  | 17.75 | 64.5 |
| LOC-6536C4-24 | \$2,952 | 163.5 | 31.4 | 35.5  | 23.75 | 64.5 |

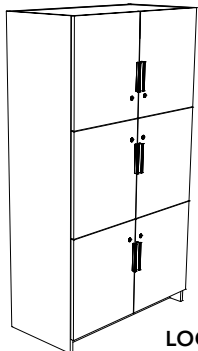

LOC-6536C6-18

**65" TALL - 6 DOOR LOCKER**

2 WIDE, 3 DOOR

|               |         |       |      |       |       |      |
|---------------|---------|-------|------|-------|-------|------|
| LOC-6524C6-18 | \$2,576 | 107.2 | 15.7 | 23.75 | 17.75 | 64.5 |
| LOC-6524C6-24 | \$2,592 | 126   | 21   | 23.75 | 23.75 | 64.5 |
| LOC-6536C6-18 | \$2,910 | 142.1 | 23.5 | 35.5  | 17.75 | 64.5 |
| LOC-6536C6-24 | \$3,046 | 163.5 | 31.4 | 35.5  | 23.75 | 64.5 |

- ALL DOORS LOCK WITH UNIQUE LOCKS
- DEFAULT BAR HANDLES

| MODEL | 388  |        |                 |    |    |    | 388 |
|-------|------|--------|-----------------|----|----|----|-----|
|       | LIST | WEIGHT | CUBE            | W  | D  | H  |     |
|       | 1"   | LBS    | FT <sup>3</sup> | IN | IN | 1" |     |

**72" TALL - 1 DOOR LOCKER**

LEFT HINGE, 1 SINGLE DOOR

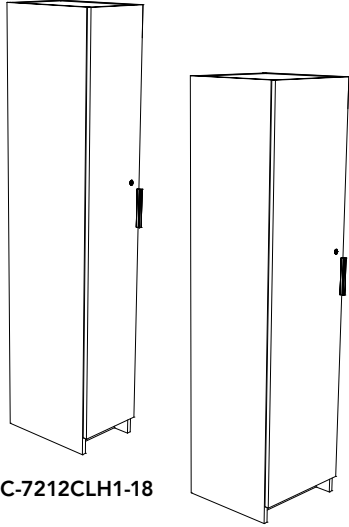

LOC-7212CLH1-18

LOC-7218CLH1-18

|                 |         |       |      |       |       |      |
|-----------------|---------|-------|------|-------|-------|------|
| LOC-7212CLH1-18 | \$1,521 | 79.4  | 8.8  | 12    | 17.75 | 71.5 |
| LOC-7212CLH1-24 | \$1,681 | 97.2  | 11.7 | 12    | 23.75 | 71.5 |
| LOC-7218CLH1-18 | \$1,648 | 98.4  | 13   | 17.75 | 17.75 | 71.5 |
| LOC-7218CLH1-24 | \$1,729 | 117.4 | 17.4 | 17.75 | 23.75 | 71.5 |

RIGHT HINGE, 1 SINGLE DOOR

|                 |         |       |      |       |       |      |
|-----------------|---------|-------|------|-------|-------|------|
| LOC-7212CRH1-18 | \$1,521 | 79.4  | 8.8  | 12    | 17.75 | 71.5 |
| LOC-7212CRH1-24 | \$1,681 | 97.2  | 11.7 | 12    | 23.75 | 71.5 |
| LOC-7218CRH1-18 | \$1,648 | 98.4  | 13   | 17.75 | 17.75 | 71.5 |
| LOC-7218CRH1-24 | \$1,729 | 117.4 | 17.4 | 17.75 | 23.75 | 71.5 |

- LOCKING DOOR
- DEFAULT BAR HANDLE

**72" TALL - 2 DOOR LOCKER**

LEFT HINGE, SINGLE WIDE 2 DOOR

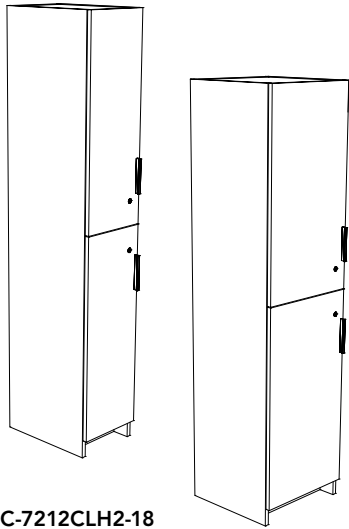

LOC-7212CLH2-18

LOC-7218CLH2-18

|                 |         |       |      |       |       |      |
|-----------------|---------|-------|------|-------|-------|------|
| LOC-7212CLH2-18 | \$1,627 | 79.4  | 8.8  | 12    | 17.75 | 71.5 |
| LOC-7212CLH2-24 | \$1,787 | 97.2  | 11.7 | 12    | 23.75 | 71.5 |
| LOC-7218CLH2-18 | \$1,754 | 98.4  | 13   | 17.75 | 17.75 | 71.5 |
| LOC-7218CLH2-24 | \$1,835 | 117.4 | 17.4 | 17.75 | 23.75 | 71.5 |

RIGHT HINGE, SINGLE WIDE 2 DOOR

|                 |         |       |      |       |       |      |
|-----------------|---------|-------|------|-------|-------|------|
| LOC-7212CRH2-18 | \$1,627 | 79.4  | 8.8  | 12    | 17.75 | 71.5 |
| LOC-7212CRH2-24 | \$1,787 | 97.2  | 11.7 | 12    | 23.75 | 71.5 |
| LOC-7218CRH2-18 | \$1,754 | 98.4  | 13   | 17.75 | 17.75 | 71.5 |
| LOC-7218CRH2-24 | \$1,835 | 117.4 | 17.4 | 17.75 | 23.75 | 71.5 |

- ALL DOORS LOCK WITH UNIQUE LOCKS
- DEFAULT BAR HANDLES

# 388/600 LOCKERS

## 72" HIGH

| MODEL | 388  |        |                 |    |    | 388 |
|-------|------|--------|-----------------|----|----|-----|
|       | LIST | WEIGHT | CUBE            | W  | D  | H   |
|       | 1"   | LBS    | FT <sup>3</sup> | IN | IN | 1"  |

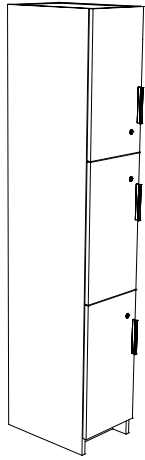

LOC-7212CLH3-18

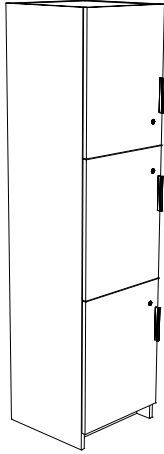

LOC-7218CLH3-18

### 72" TALL - 3 DOOR LOCKER

LEFT HINGE, SINGLE WIDE 3 DOOR

|                 |         |       |      |       |       |      |
|-----------------|---------|-------|------|-------|-------|------|
| LOC-7212CLH3-18 | \$1,733 | 79.4  | 8.8  | 12    | 17.75 | 71.5 |
| LOC-7212CLH3-24 | \$1,893 | 97.2  | 11.7 | 12    | 23.75 | 71.5 |
| LOC-7218CLH3-18 | \$1,860 | 98.4  | 13   | 17.75 | 17.75 | 71.5 |
| LOC-7218CLH3-24 | \$1,941 | 117.4 | 17.4 | 17.75 | 23.75 | 71.5 |

RIGHT HINGE, SINGLE WIDE 3 DOOR

|                 |         |       |      |       |       |      |
|-----------------|---------|-------|------|-------|-------|------|
| LOC-7212CRH3-18 | \$1,733 | 79.4  | 8.8  | 12    | 17.75 | 71.5 |
| LOC-7212CRH3-24 | \$1,893 | 97.2  | 11.7 | 12    | 23.75 | 71.5 |
| LOC-7218CRH3-18 | \$1,860 | 98.4  | 13   | 17.75 | 17.75 | 71.5 |
| LOC-7218CRH3-24 | \$1,941 | 117.4 | 17.4 | 17.75 | 23.75 | 71.5 |

- ALL DOORS LOCK WITH UNIQUE LOCKS
- DEFAULT BAR HANDLES

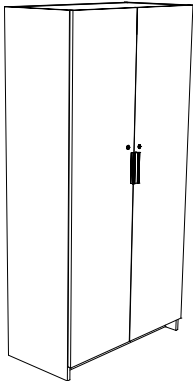

LOC-7236C2-18

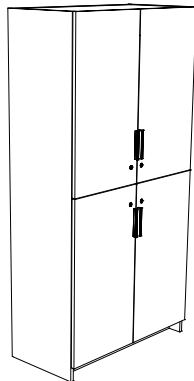

LOC-7236C4-18

### 72" TALL - 2 DOORS LOCKER

2 WIDE, SINGLE DOOR

|               |         |       |      |       |       |      |
|---------------|---------|-------|------|-------|-------|------|
| LOC-7224C2-18 | \$2,443 | 117.3 | 17.4 | 23.75 | 17.75 | 71.5 |
| LOC-7224C2-24 | \$2,567 | 137.6 | 23.3 | 23.75 | 23.75 | 71.5 |
| LOC-7236C2-18 | \$2,661 | 155.3 | 26   | 35.5  | 17.75 | 71.5 |
| LOC-7236C2-24 | \$2,848 | 178.2 | 34.8 | 35.5  | 23.75 | 71.5 |

### 72" TALL - 4 DOORS LOCKER

2 WIDE, 2 DOOR

|               |         |       |      |       |       |      |
|---------------|---------|-------|------|-------|-------|------|
| LOC-7224C4-18 | \$2,549 | 117.3 | 17.4 | 23.75 | 17.75 | 71.5 |
| LOC-7224C4-24 | \$2,673 | 137.6 | 23.3 | 23.75 | 23.75 | 71.5 |
| LOC-7236C4-18 | \$2,886 | 155.3 | 26   | 35.5  | 17.75 | 71.5 |
| LOC-7236C4-24 | \$3,085 | 178.2 | 34.8 | 17.75 | 23.75 | 71.5 |

### 72" TALL - 6 DOORS LOCKER

2 WIDE, 3 DOOR

|               |         |       |      |       |       |      |
|---------------|---------|-------|------|-------|-------|------|
| LOC-7224C6-18 | \$2,708 | 117.3 | 17.4 | 23.75 | 17.75 | 71.5 |
| LOC-7224C6-24 | \$2,724 | 137.6 | 23.3 | 23.75 | 23.75 | 71.5 |
| LOC-7236C6-18 | \$2,984 | 155.3 | 26   | 35.5  | 17.75 | 71.5 |
| LOC-7236C6-24 | \$3,233 | 178.2 | 34.8 | 35.5  | 23.75 | 71.5 |

- ALL DOORS LOCK WITH UNIQUE LOCKS
- DEFAULT BAR HANDLES

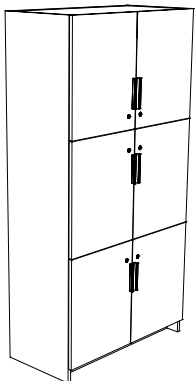

LOC-7236C6-18



|  | ITEMS   | ITEM DESCRIPTION   | QTY  | 388/600 LIST   |                  |
|--|---|--------------------|--|----------------|------------------|
|  | <b>LAYOUT #1 (SHOWN IN 388 SERIES BROCHURE)</b> |                    |  |                |                  |
|  |   | 388-BF4272F        | DOUBLE PEDESTAL BOW TOP DESK                             |                | \$1,866          |
|  |   | 388-2036LF         | LATERAL FILE   |                | \$1,113          |
|  |   | 388-2072CT-A       | FREESTANDING CONNECTOR TOP                               |                | \$801            |
|  |   | 388-19FPUFX        | FREESTANDING - BBF - NO TOP                              |                | \$871            |
|  |   | 388-19FPFFX        | FREESTANDING PED - FF - NO TOP                           |                | \$939            |
|  |   | 388-3672HHD-AGD-FR | HUTCH W/ ALUM GLAZED HINGED DOORS<br><i>AGD UPCHARGE</i> |                | \$1,393<br>\$893 |
|  |   | 388-3672TB         | TACKBOARD FOR 72" HUTCH                                  |                | \$357            |
|  |   | 388-2920CSR        | CORNER SHELF - RIGHT                                     |                | \$514            |
|  |   | 388-3616HCSR       | HUTCH CORNER SHELF - RIGHT                               |                | \$514            |
|  |   | 100-AKTM-2         | ARTICULATING KEYBOARD TRAY                               |                | \$275            |
|  |   |                    | <b>TOTAL</b>   |                | <b>\$9,536</b>   |
|  |   | <b>LAYOUT #2</b>   |  |                |                  |
|  |   | 388-3672BTG        | BULLET TOPS WITH GABLE                                   |                | \$935            |
|  |   | 388-2442BR         | BRIDGE RETURN - 24" DEEP                                 |                | \$576            |
|  |   | 388-3672CM-B       | EXTENDED CORNER MODULE                                   |                | \$1,168          |
|  |   | 388-3672HHD        | HUTCH W/ HINGED DOORS - 36" HIGH                         |                | \$1,393          |
|  |   | 388-3672TB         | TACKBOARD FOR 72" HUTCH                                  |                | \$357            |
|  |   | 388-1236VC         | VERTICAL CUBBY-HOLE                                      |                | \$384            |
|  |   | 388-6524CUFWR-24   | PERSONAL WARDROBE STORAGE - RIGHT                        |                | \$2,281          |
|  |   | 100-KD28           | KEYBOARD DRAWER  |                | \$202            |
|  |   |                    | <b>TOTAL</b>   |                | <b>\$7,296</b>   |
|  | <b>LAYOUT #3</b>                                |                    |  |                |                  |
|  |   | 388-7236UFL-20     | STORAGE CABINET/LATERAL COMBO                            |                | \$2,453          |
|  |   | 388-2436LC-CR-B    | LEFT CONNECTOR - CUTBACK RIGHT                           |                | \$646            |
|  |   | 388-1836CM-C       | CORNER MODULE  |                | \$820            |
|  |   | 388-2436RC-CL-C    | RIGHT CONNECTOR - CUTBACK LEFT                           |                | \$646            |
|  |   | 388-HPF            | HANGING BOX/FILE PEDESTAL                                |                | \$752            |
|  |   | 388-4372HFD        | HUTCH W/ FLIPPER DOORS - 43" H                           |                | \$1,656          |
|  |   | 388-4372TB         | TACKBOARD FOR 72" HUTCH                                  |                | \$387            |
|  |   | 388-7204HC         | HORIZONTAL CUBBY-HOLE                                    |                | \$463            |
|  |   | 388-3072PTG-R      | P-TOP RIGHT  |                | \$1,081          |
|  |   | 100-KD28           | KEYBOARD DRAWER  |                | \$202            |
|  |   | <b>TOTAL</b>       |  | <b>\$9,106</b> |                  |
|  | <b>LAYOUT #4</b>                                |                    |  |                |                  |
|  |   | 388-7242CMPTM      | CORNER MODULE P-TOP                                      |                | \$1,650          |
|  |   | 388-2436BR         | BRIDGE   |                | \$543            |
|  |   | 388-1860OSFD       | OVERHEAD STORAGE W/ FLIPPER DOORS                        |                | \$1,082          |
|  |   | 388-1816OSCSL      | O.H. STORAGE CORNER SHELF - LEFT                         |                | \$444            |
|  |   | 388-2472CT-A       | FREESTANDING CONNECTOR TOP                               |                | \$801            |
|  |   | 388-1936UFLX       | LATERAL FILE / BBF COMBO - NO TOP                        |                | \$1,405          |
|  |   | 100-KB2            | ARTICULATING KEYBOARD TRAY                               |                | \$305            |
|  |   | <b>TOTAL</b>       |  | <b>\$6,230</b> |                  |

# 388/600 SERIES LAYOUTS

|  | ITEMS   | ITEM DESCRIPTION             | QTY | 388/600 LIST   |
|--|---|------------------------------|-----|----------------|
|  | <b>LAYOUT #5 (SHOWN IN 388 SERIES BROCHURE)</b> |                              |     |                |
|  | 388-2430RS                                      | RETURN SHELL                 |     | <b>\$576</b>   |
|  | 388-3666CM-B                                    | CORNER MODULE EXTENDED RIGHT |     | <b>\$1,113</b> |
|  | 388-HPF   | HANGING BOX/FILE PEDESTAL    |     | <b>\$752</b>   |
|  | 388-3666H                                       | OPEN HUTCH - 36" H           |     | <b>\$840</b>   |
|  | 388-3666TB                                      | TACKBOARD FOR 66" HUTCH      |     | <b>\$334</b>   |
|  | 100-KB2   | ARTICULATING KEYBOARD TRAY   |     | <b>\$305</b>   |
|  | <b>TOTAL</b>                                    |                              |     | <b>\$3,920</b> |

|  |                  |                                 |  |                |
|--|------------------|---------------------------------|--|----------------|
|  | <b>LAYOUT #6</b> |                                 |  |                |
|  | 388-F3672        | SINGLE LEFT PEDESTAL DESK       |  | <b>\$1,321</b> |
|  | 388-2048BR       | BRIDGE RETURN                   |  | <b>\$471</b>   |
|  | 388-2072F        | SINGLE RIGHT PEDESTAL CREDENZA  |  | <b>\$1,144</b> |
|  | 388-3672HHD      | HUTCH W/ HINGED DOORS- 36" HIGH |  | <b>\$1,393</b> |
|  | 388-3672TB       | TACKBOARD FOR 72" HUTCH         |  | <b>\$357</b>   |
|  | 100-KD28         | KEYBOARD DRAWER                 |  | <b>\$202</b>   |
|  | <b>TOTAL</b>     |                                 |  | <b>\$4,888</b> |

|  |                       |   |  |                                |
|--|-----------------------|---|--|--------------------------------|
|  | <b>LAYOUT #7</b>      |   |  |                                |
|  | 388-B7248CMD          | BOW FRONT BOW TOP CORNER MODULE DESK LEFT                     |  | <b>\$1,708</b>                 |
|  | 388-2436BR            | 24" DEEP BRIDGE   |  | <b>\$543</b>                   |
|  | 388-2072CT-A          | FREESTANDING CONNECTOR TOP                                    |  | <b>\$801</b>                   |
|  | 388-3672HHD-AGD-FR    | HUTCH W/ HINGED DOORS - 36" HIGH<br><i>AGD UPCHARGE</i>       |  | <b>\$1,393</b><br><b>\$893</b> |
|  | 388-3672TB            | TACKBOARD FOR 72" HUTCH                                       |  | <b>\$357</b>                   |
|  | 388-19FPUFX           | FREESTANDING PEDESTAL - NO TOP                                |  | <b>\$871</b>                   |
|  | 388-6536CLF-20-AGD-FR | TALL CAB/LAT FILE W/ ALUM GLAZED DOORS<br><i>AGD UPCHARGE</i> |  | <b>\$2,113</b><br><b>\$769</b> |
|  | 388-6520CSR           | FREESTANDING CORNER SHELF - RIGHT                             |  | <b>\$871</b>                   |
|  | 100-KB2               | ARTICULATING KEYBOARD TRAY                                    |  | <b>\$305</b>                   |
|  | <b>TOTAL</b>          |   |  | <b>\$10,624</b>                |

|  |                   |  |    |                 |
|--|-------------------|--|----|-----------------|
|  | <b>LAYOUT #8</b>  |  |    |                 |
|  | 388-2436LC-CR-AGC | LEFT CONNECTOR - CUTBACK RIGHT W/ GALLERY BACK | 4X | <b>\$905</b>    |
|  | 388-1836CM-CGMC   | CORNER MODULE W/ 1 GALLERY BACK LEFT           | 4X | <b>\$1,149</b>  |
|  | 388-2436RC-CL-B   | RIGHT CONNECTOR - CUTBACK LEFT                 | 4X | <b>\$646</b>    |
|  | 388-1261BGT       | BULLET GALLERY TOP                             | 4X | <b>\$262</b>    |
|  | 388-1271XTB       | TACKBOARD                                      | 8X | <b>\$330</b>    |
|  | 388-2212QUADTOP   | 4 WAY TOP                                      |    | <b>\$440</b>    |
|  | 388-HPF           | HANGING B/F PED                                | 4X | <b>\$752</b>    |
|  | 100-KB2           | ARTICULATING KEYBOARD TRAY                     | 4X | <b>\$305</b>    |
|  | <b>TOTAL</b>      |  |    | <b>\$19,156</b> |

|            | ITEMS  | ITEM DESCRIPTION   | QTY     | 388/600 LIST    |
|------------|--|--|---------|-----------------|
|            | <b>LAYOUT #9</b>                                 |  |         |                 |
|            | 388-G3672DS                                      | GALLERY RECEPTION DESK SHELL   |         | \$1,841         |
|            | 388-G2442RS                                      | GALLERY RETURN SHELL - NON HANDED  |         | \$880           |
|            | 388-HPF  | B/F HANGING PEDESTAL   | 2X      | \$752           |
|            | 388-LF2072C                                      | LATERAL FILE/CABINET CREDENZA  |         | \$2,229         |
|            | 388-4872HHD                                      | HUTCH W/ HINGED DOORS - 48" HIGH   |         | \$2,276         |
|            | 388-3672TB                                       | TACKBOARD  |         | \$357           |
|            | 100-KD28   | KEYBOARD DRAWER  |         | \$202           |
|            | <b>TOTAL</b>                                     |  |         | <b>\$9,289</b>  |
|            | <b>LAYOUT #10 (SHOWN IN 388 SERIES BROCHURE)</b> |  |         |                 |
|            | 388-2436LC-CR-AGC                                | LEFT CONNECTOR - CUTBACK RIGHT W/ GALLERY BACK   |         | \$905           |
|            | 388-1836CM-CGGC                                  | GALLERY CORNER MODULE  |         | \$1,232         |
|            | 388-2436RC-CL-CGA                                | RIGHT CONNECTOR - CUTBACK RIGHT W/ GALLERY BACK  |         | \$905           |
|            | 388-1627MPUF                                     | B/B/F MOBILE PEDESTAL  |         | \$965           |
|            | 388-HPF  | B/F HANGING PEDESTAL   | 2X      | \$752           |
|            | 388-1260GT                                       | GALLERY TOP  |         | \$290           |
|            | 388-17.517.5RCI                                  | RADIUS CORNER INSERT   |         | \$335           |
| 100-KD28   | KEYBOARD DRAWER                                  |  | \$202   |                 |
|            | <b>TOTAL</b>                                     |  |         | <b>\$5,876</b>  |
|            | <b>LAYOUT #11 (SHOWN IN 388 SERIES BROCHURE)</b> |  |         |                 |
|            | 388-SB4272DS-AGM                                 | BOW TOP DESK SHELL W/ GLAZED MP  |         | \$2,116         |
|            | 388-2072CT-A                                     | FREESTANDING CONNECTOR TOP   |         | \$801           |
|            | 388-19FPUFX                                      | FREESTANDING PEDESTAL - NO TOP   |         | \$871           |
|            | 388-19FPFFX                                      | FREESTANDING PEDESTAL - NO TOP   |         | \$939           |
|            | 388-3672HHD-AGD-BR                               | HUTCH W/ ALUM GLAZED HINGED DOORS<br><i>AGD UPCHARGE</i>                               |         | \$1,393         |
|            | 388-3672TB                                       | TACKBOARD  |         | \$893           |
|            | 388-6536CLF-20-AGD-BR                            | CABINET/LATERAL FILE W/ GLAZED DOORS<br><i>AGD UPCHARGE</i>                            |         | \$357           |
| 100-AKTM-2 | ARTICULATING KEYBOARD TRAY                       |  | \$2,113 |                 |
|            | <b>TOTAL</b>                                     |  |         | <b>\$10,527</b> |
|            | <b>LAYOUT #12 (SHOWN IN 388 SERIES BROCHURE)</b> |  |         |                 |
|            | 388-SB7248CMD-AGM                                | EXTENDED LEFT BOW TOP CORNER MODULE DESK W/<br>EXTENDED PEDS                           |         | \$2,471         |
|            | 388-2436BR                                       | 24" DEEP   |         | \$543           |
|            | 388-2472FF                                       | SINGLE RIGHT PEDESTAL CREDENZA   |         | \$1,373         |
|            | 388-3672HHD-AGD-FR                               | HUTCH W/ ALUM GLAZED HINGED DOORS<br><i>AGD UPCHARGE</i>                               |         | \$1,393         |
|            | 388-3672TB                                       | TACKBOARD  |         | \$893           |
|            | 388-6524CUFWR-24-AGD-FR                          | PERSONAL WARDROBE STORAGE- RIGHT W/ ALUM<br>GLAZED HINGED DOORS<br><i>AGD UPCHARGE</i> |         | \$357           |
|            | 100-KD28   | KEYBOARD DRAWER  |         | \$2,281         |
|            | <b>TOTAL</b>                                     |  |         | <b>\$10,544</b> |

# 388/600 SERIES LAYOUTS

|  | ITEMS  | ITEM DESCRIPTION                   | QTY | 388/600 LIST   |
|--|--|------------------------------------|-----|----------------|
|  | <b>LAYOUT #13 (SHOWN IN 388 SERIES BROCHURE)</b> |                                    |     |                |
|  | 388-3672JCM                                      | J TOP CORNER MODULE EXTENDED RIGHT |     | <b>\$1,168</b> |
|  | 388-2436CT-B                                     | 24" CONNECTOR TOP                  |     | <b>\$615</b>   |
|  | 388-HPF  | HANGING PEDESTAL                   |     | <b>\$752</b>   |
|  | 388-3672H  | HUTCH                              |     | <b>\$990</b>   |
|  | 388-3672TB                                       | TACKBOARD                          |     | <b>\$357</b>   |
|  | 100-KB2  | ARTICULATING KEYBOARD TRAY         |     | <b>\$305</b>   |
|  |  | <b>TOTAL</b>                       |     | <b>\$4,187</b> |

|                  |   |  |              |                 |
|------------------|---|--|--------------|-----------------|
|                  | <b>LAYOUT #14 (SHOWN IN 388 SERIES BROCHURE - PERSONAL WORKSTATION P-TOP)</b> |  |              |                 |
|                  | 388-3072PTG-R   | P-TOP RIGHT W/ FULL GABLE & SQUARE LEG     |              | <b>\$1,081</b>  |
|                  | 388-2436RC-CL   | 24" RIGHT CONNECTOR, CUTBACK LEFT          |              | <b>\$646</b>    |
|                  | 388-2436LC-CR   | 24" LEFT CONNECTOR, CUTBACK RIGHT          |              | <b>\$646</b>    |
|                  | 388-1836CM-B2   | CORNER MODULE                              |              | <b>\$820</b>    |
|                  | 388-4872HHD-AGD-FR  | DBLE HIGH HUTCH WITH HINGED AGD DOORS      |              | <b>\$2,276</b>  |
|                  |   | <i>AGD UPGRADE</i>                         |              | <b>\$1,293</b>  |
|                  | 388-3672TB  | TACKBOARD                                  |              | <b>\$357</b>    |
|                  | 388-7204HC  | HORIZONTAL CUBBY-HOLE                      |              | <b>\$463</b>    |
|                  | 100-KB2   | ARTICULATING KEYBOARD TRAY                 |              | <b>\$305</b>    |
|                  | 388-2036LF3   | 3 DRAWER LATERAL. INCLUDES ANTI-TILT LOCK. |              | <b>\$2,156</b>  |
|                  | 388-1836OSHD-AGD-FR   | OVERHEAD STORAGE WITH AGD DOORS            |              | <b>\$782</b>    |
|                  |   | <i>AGD UPGRADE</i>                         |              | <b>\$466</b>    |
|                  | 388-1836VC  | VERTICLE CUBBY                             |              | <b>\$446</b>    |
| WRK-1621MPBO-R   | 21" MOBILE PEDESTAL   |  | <b>\$674</b> |                 |
| WRK-MPEDCUSH-ULT | 21" MOBILE PEDESTAL CUSHION (PARROT)  |  | <b>\$456</b> |                 |
|                  |   | <b>TOTAL</b>                               |              | <b>\$12,867</b> |

|            |   |                          |                |                |
|------------|---|--------------------------|----------------|----------------|
|            | <b>LAYOUT #15 - (SHOWN IN 388 SERIES BROCHURE - PERSONAL WORKSTATION WITH CLOSET)</b> |                          |                |                |
|            | 388-6524CUFWL-24  | WARDROBE STORAGE         |                | <b>\$2,281</b> |
|            | 388-19FPFFX   | FREESTANDING PEDESTAL    |                | <b>\$939</b>   |
|            | 388-2472CT-A  | 24" CONNECTOR TOP        |                | <b>\$801</b>   |
|            | 388-3672HFD   | HUTCH WITH FLIPPER DOORS |                | <b>\$1,448</b> |
|            | 388-7204HC  | HORIZONTAL CUBBY-HOLE    |                | <b>\$463</b>   |
|            | 388-3672TB  | TACKBOARD FOR 72" HUTCH  |                | <b>\$357</b>   |
|            | 388-2048BR  | BRIDGE RETURN            |                | <b>\$471</b>   |
| 388-3672DS | DESK SHELL  |                          | <b>\$1,077</b> |                |
|            |   | <b>TOTAL</b>             |                | <b>\$7,837</b> |

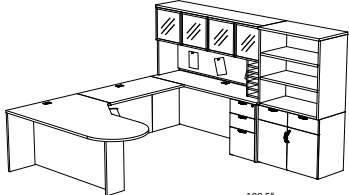
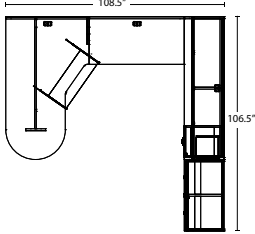
| ITEMS  | ITEM DESCRIPTION          | QTY  | 388/600 LIST                   |
|--|---------------------------|--|--------------------------------|
| <b>LAYOUT #16 - (SHOWN IN 388 SERIES BROCHURE - COVER)</b>   |                           |  |                                |
|                   | <b>388-7242CMBTM</b>      | LEFT EXTENSION W/ FULL MP & GABLE LEG                    | <b>\$1,551</b>                 |
|  | <b>388-2448BR</b>         | BRIDGE RETURN  | <b>\$583</b>                   |
|  | <b>388-2072UF</b>         | PEDESTAL CREDENZA - BOX / BOX / FILE                     | <b>\$1,339</b>                 |
|  | <b>388-3672HHD-AGD-FR</b> | HUTCH W/ ALUM GLAZED HINGED DOORS<br><i>AGD UPCHARGE</i> | <b>\$1,393</b><br><b>\$893</b> |
|  | <b>388-3672TB</b>         | TACKBOARD FOR 72" HUTCH                                  | <b>\$357</b>                   |
|  | <b>388-1236VC</b>         | VERTICAL CUBBY-HOLE - DESIGNED TO FIT IN HUTCHES         | <b>\$384</b>                   |
|  | <b>388-1936DCX</b>        | CABINET - DRAWERS OVER DOORS - NO TOP                    | <b>\$1,248</b>                 |
|  | <b>388-3736SBK-19</b>     | STACKING BOOKCASE  | <b>\$983</b>                   |
|  | <b>100-KD28</b>           | KEYBOARD DRAWER  | <b>\$202</b>                   |
|                   |                           |  |                                |
|  |                           | TOTAL  | <b>\$8,933</b>                 |
| <b>NOTE: FOR LAYOUT 16B AS SHOWN IN THE 388 SERIES BROCHURE USE 388-4272CMBTM &amp; 388-UF2072</b> |                           |  |                                |

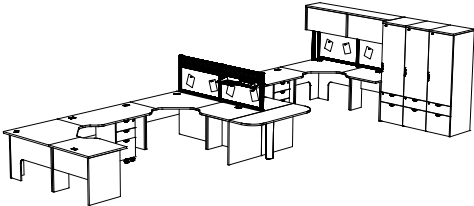
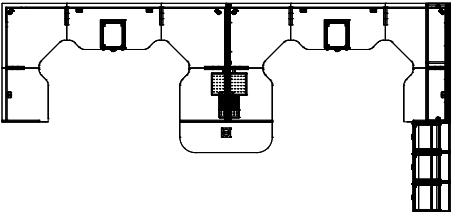
|   |                          |  |                   |
|---|--------------------------|--|-------------------|
| <b>LAYOUT #17 - (SHOWN IN 388 SERIES BROCHURE - DBLE WORKSTATION WITH OUTLINES)</b> |                          |  |                   |
|   | <b>388-R3036LC-CR-B2</b> | RECESSED 30" LT CONNECTOR, CUTBACK RT W/ 1/2 HEIGHT MP | <b>\$717</b>      |
|   | <b>388-R2442CM-C2</b>    | RECESSED CORNER MODULE W/ 1/2 HEIGHT MP                | 2X <b>\$973</b>   |
|   | <b>OUT1-4178HFD</b>      |  | <b>\$1,830</b>    |
|   | <b>OUT-2478TBP</b>       | 24" OUTLINES TACK BOARD PANEL (HUTCH)                  | <b>\$663</b>      |
|   | <b>388-R3060CC-CD-C2</b> | RECESSED 30" CENTER CONNECTOR, CUTBACK DBLE            | 2X <b>\$868</b>   |
|   | <b>388-RF2442CM-C4</b>   | CORNER MODULE W/ 1/2 HEIGHT RECESSED LT HAND MP        | <b>\$973</b>      |
|   | <b>388-3036RC-CL-B</b>   | 30" RIGHT CONNECTOR, CUTBACK LEFT                      | <b>\$717</b>      |
|   | <b>388-3036LC-CR-B</b>   | 30" LEFT CONNECTOR, CUTBACK RIGHT                      | <b>\$717</b>      |
|   | <b>388-FR2442CM-C6</b>   | CORNER MODULE W/ 1/2 HEIGHT RECESSED RT H& MP          | <b>\$973</b>      |
|   | <b>388-R3036RC-CL-B2</b> | RECESSED 30" RT CONNECTOR, CUTBACK LT W/ 1/2 HEIGHT MP | <b>\$717</b>      |
|  | <b>COUT1-7020CF-R-24</b> | TALL STORAGE, CABINET BOX/FILE - HINGED RIGHT          | 3X <b>\$1,840</b> |
|   | <b>C910-REC6020</b>      | CUSTOM RECTANGLE TOP                                   | <b>\$613</b>      |
|   | <b>900-RL5</b>           | 4 3/4" ROUND LEG                                       | <b>\$163</b>      |
|   | <b>388-1627MPUF</b>      | MOBILE PEDESTAL  | 2X <b>\$965</b>   |
|   | <b>OUT-24POST</b>        | 24" OUTLINES POST PACKAGE                              | 3X <b>\$158</b>   |
|   | <b>OUT-1878TBP</b>       | OUTLINES 18" TACK BOARD PANEL                          | <b>\$641</b>      |
|   | <b>COU-678PYP</b>        | CUSTOM 6" POLYCARBONATE PANEL                          | <b>\$538</b>      |
|   | <b>OUT-LTRLND</b>        | LETTER TRAY - LANDSCAPE                                | 2X <b>\$68</b>    |
|   | <b>OUT-ACCTRY</b>        | ACCESSORY TRAY   | 2X <b>\$59</b>    |
|   | <b>WRK-WABK</b>          | WORK SURFACE ANGLE BRACKET KIT                         | <b>\$40</b>       |
|   |                          | TOTAL  | <b>\$21,162</b>   |

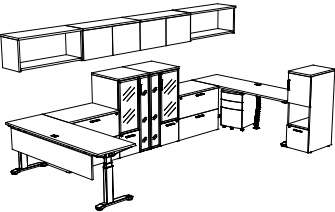
|   |                            |   |                                |
|---|----------------------------|---|--------------------------------|
| <b>LAYOUT #18 - (SHOWN IN 388 SERIES BROCHURE - DBLE WORKSTATION WITH APOLLO)</b>   |                            |   |                                |
|   | <b>388-2436LF</b>          | 36" LATERAL FILE                                    | 2X <b>\$1,167</b>              |
|  | <b>100-MMPUF</b>           | METAL MOBILE PEDESTAL - FULL CARTON                 | <b>\$540</b>                   |
|   | <b>388-1842OS</b>          | OVERHEAD STORAGE - OPEN                             | 2X <b>\$591</b>                |
|   | <b>388-1842OSHD</b>        | OVERHEAD STORAGE - W/ HINGED DOORS                  | 2X <b>\$837</b>                |
|   | <b>388-4716COF24-R</b>     | MID-HEIGHT CABINET/ OPEN/FILE DRAWER CABINET        | <b>\$897</b>                   |
|   | <b>388-4724CFWR-24-AGD</b> | MID-HEIGHT WARDROBE STORAGE<br><i>AGD UP-CHARGE</i> | <b>\$1,594</b><br><b>\$762</b> |

**CONTINUED....**

# 388/600 SERIES NEO ANGLE CORNER MODULE LAYOUTS

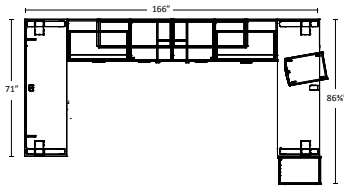
| ITEMS  | ITEM DESCRIPTION   | QTY | 388/600 LIST                   |
|--|--|-----|--------------------------------|
|  | <b>388-4724CFWL-24-AGD</b> MID-HEIGHT WARDROBE STORAGE<br><i>AGD UP-CHARGE</i> |     | <b>\$1,594</b><br><b>\$762</b> |
|  | <b>CAL-E1-2LEG</b> HEIGHT ADJUSTABLE 2 LEG BASE                                | 2X  | <b>\$1,364</b>                 |
|  | <b>CAL-REC3060</b> 30" RECTANGLE TOP   | 2X  | <b>\$410</b>                   |
|  | <b>CAL-MP1860LAP</b> 18" LAMINATE MODESTY PANELS                               |     | <b>\$264</b>                   |
|  | <b>100-WM1300</b> FLOOR WIRE MANAGEMENT  |     | <b>\$127</b>                   |
| <b>TOTAL</b>   |  |     | <b>\$15,278</b>                |

## LAYOUT 19

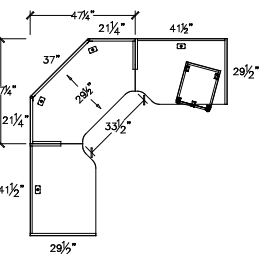
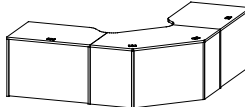
|   |  |  |                |
|---|--|--|----------------|
|   | <b>388-2448NACM</b> NEO-ANGLE CORNER MODULE            |  | <b>\$1,325</b> |
|  | <b>388-3042LC-CR</b> 30" LEFT CONNECTOR, CUTBACK RIGHT |  | <b>\$745</b>   |
|   | <b>388-3042RC-CL</b> 30" RIGHT CONNECTOR, CUTBACK LEFT |  | <b>\$745</b>   |
|   | <b>388-1627MPUF</b> MOBILE PEDESTAL                    |  | <b>\$965</b>   |
| <b>TOTAL</b>  |  |  | <b>\$3,780</b> |

## LAYOUT 20

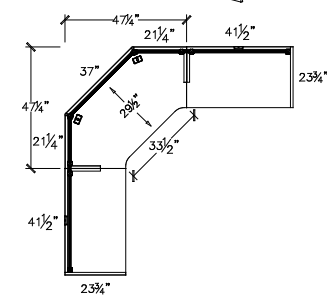
|  |   |     |                |
|--|---|-----|----------------|
|  | <b>388-2448NACM</b> NEO-ANGLE CORNER MODULE                   |     | <b>\$1,325</b> |
|  | <b>388-2442CT-B</b> 24" CONNECTOR TOP                         | 2 X | <b>\$638</b>   |
|  | <b>OUT-12POST</b> OUTLINES POST PACKAGE                       | 8 X | <b>\$94</b>    |
|  | <b>OUT-1242PYP-F</b> 12" POLYCARBONATE PANELS                 | 2 X | <b>\$323</b>   |
|  | <b>OUT-1248PYP-NAPS</b> 12" POLYCARBONATE NEO-ANGLE PANEL SET |     | <b>\$719</b>   |
| <b>TOTAL</b>   |   |     | <b>\$4,718</b> |

## LAYOUT 21

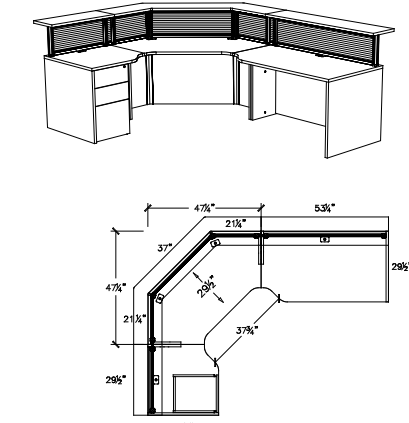
|  |   |     |                |
|--|---|-----|----------------|
|  | <b>388-3030LC-CR</b> 30" LEFT CONNECTOR, CUTBACK RIGHT        |     | <b>\$683</b>   |
|  | <b>388-2448NACM</b> NEO-ANGLE CORNER MODULE                   |     | <b>\$1,325</b> |
|  | <b>388-3054RC-CL</b> 30" RIGHT CONNECTOR, CUTBACK LEFT        |     | <b>\$814</b>   |
|  | <b>388-19FPUFX</b> FREESTANDING PEDESTAL - NO TOP             |     | <b>\$871</b>   |
|  | <b>OUT-12POST</b> OUTLINES POST PACKAGE                       | 8 X | <b>\$94</b>    |
|  | <b>OUT-1230PYP-F</b> 12" POLYCARBONATE PANEL                  |     | <b>\$240</b>   |
|  | <b>OUT-1254PYP-F</b> 12" POLYCARBONATE PANEL                  |     | <b>\$414</b>   |
|  | <b>OUT-1248PYP-NAPS</b> 12" POLYCARBONATE NEO-ANGLE PANEL SET |     | <b>\$719</b>   |
|  | <b>OUT1-1254TA</b> TRANSACTION TOP                            |     | <b>\$277</b>   |
|  | <b>OUT1-1248NATA</b> NEO ANGLE TRANSACTION TOP                |     | <b>\$534</b>   |
|  | <b>OUT1-1230TA</b> TRANSACTION TOP                            |     | <b>\$166</b>   |
| <b>TOTAL</b>   |   |     | <b>\$6,795</b> |

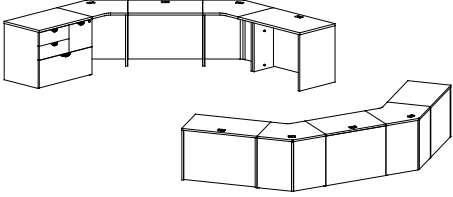
| ITEMS   | ITEM DESCRIPTION    | QTY                        | 388/600 LIST     |
|---|---------------------|----------------------------|------------------|
| <b>LAYOUT 22</b>  |                     |                            |                  |
|  | <b>388-2424NACW</b> | 24" NEO ANGLE CORNER WEDGE | 2 X <b>\$896</b> |
|   | <b>388-2436CT-C</b> | 24" CONNECTOR TOP          | <b>\$615</b>     |
|   | <b>388-2442CT-B</b> | 24" CONNECTOR TOP          | <b>\$638</b>     |
|   | <b>388-2436UFL</b>  | LATERAL BBF COMBO          | <b>\$1,491</b>   |
|   | <b>TOTAL</b>        |                            | <b>\$4,536</b>   |

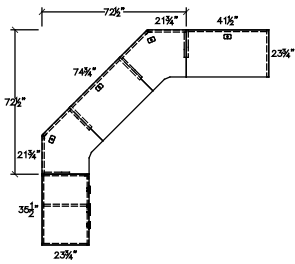

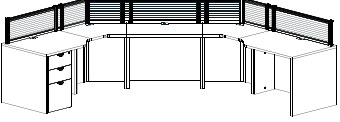
|   |                            |                                     |                  |
|---|----------------------------|-------------------------------------|------------------|
| <b>LAYOUT 23</b>  |                            |                                     |                  |
|  | <b>388-2424NACW</b>        | NEO ANGLE CORNER WEDGE              | 2 X <b>\$896</b> |
|   | <b>388-3036LC-CR</b>       | LEFT CONNECTOR, CUTBACK RIGHT       | <b>\$717</b>     |
|   | <b>388-3042RC-CL</b>       | RIGHT CONNECTOR, CUTBACK LEFT       | <b>\$745</b>     |
|   | <b>388-19FPUFX</b>         | FREE STANDING PEDESTAL              | <b>\$871</b>     |
|   | <b>388-2436CT-C</b>        | 24" CONNECTOR TOP                   | <b>\$615</b>     |
|   | <b>OUT-1224PYP-NAWPS-F</b> | NEO ANGLE WEDGE PANEL SET W/ FILLER | 2 X <b>\$505</b> |
|   | <b>OUT-1236PYP</b>         | 12" POLYCARBONATE PANEL             | 2 X <b>\$289</b> |
|   | <b>OUT-1242PYP</b>         | 12" POLYCARBONATE PANEL             | <b>\$323</b>     |
|   | <b>OUT-12POST</b>          | OUTLINES POST PACKAGE               | 12 X <b>\$94</b> |
|   | <b>TOTAL</b>               |                                     | <b>\$7,779</b>   |

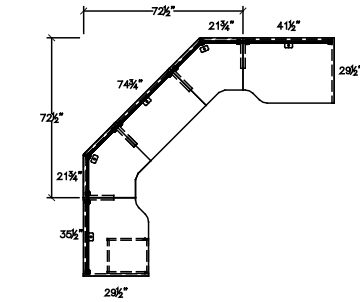

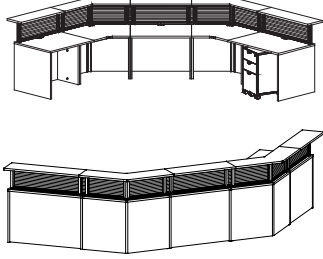
|   |                            |                                     |                    |
|---|----------------------------|-------------------------------------|--------------------|
| <b>LAYOUT 24</b>  |                            |                                     |                    |
|  | <b>388-3030NACW</b>        | NEO ANGLE CORNER WEDGE              | 2 X <b>\$1,059</b> |
|   | <b>388-3036CT-C</b>        | 30" CONNECTOR TOP                   | <b>\$683</b>       |
|   | <b>388-3042CT-B</b>        | 30" CONNECTOR TOP                   | <b>\$711</b>       |
|   | <b>388-3036CT-B</b>        | 30" CONNECTOR TOP                   | <b>\$683</b>       |
|   | <b>388-1627MPUF</b>        | MOBILE PEDESTAL                     | <b>\$965</b>       |
|   | <b>OUT-1230PYP-NAWPS-F</b> | NEO ANGLE WEDGE PANEL SET W/ FILLER | 2 X <b>\$505</b>   |
|   | <b>OUT-1236PYP</b>         | 12" POLYCARBONATE PANEL             | 2 X <b>\$289</b>   |
|   | <b>OUT-1242PYP</b>         | 12" POLYCARBONATE PANEL             | <b>\$323</b>       |
|   | <b>OUT1-1230NATAW</b>      | NEO ANGLE WEDGE TRANSACTION         | 2 X <b>\$419</b>   |
|   | <b>OUT1-1236TA</b>         | STRAIGHT TRANSACTION TOP            | 2 X <b>\$179</b>   |
|   | <b>OUT1-1242TA</b>         | STRAIGHT TRANSACTION TOP            | <b>\$223</b>       |
|   | <b>OUT-12POST</b>          | OUTLINES POST PACKAGE               | 12 X <b>\$94</b>   |
|   | <b>TOTAL</b>               |                                     | <b>\$9,618</b>     |

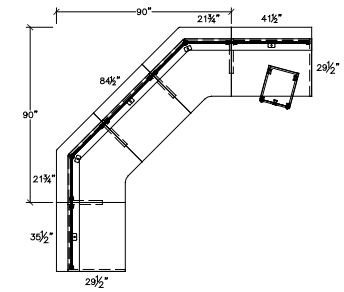

# 388/600 SERIES LAYOUTS

|   | ITEMS                  | ITEM DESCRIPTION                                      | QTY          | 388/600 LIST    |
|---|------------------------|---|--------------|-----------------|
|   | <b>LAYOUT #25</b>      |   |              |                 |
|   | 600-B7248CMD           | BOW TOP CORNER MODULE DESK LEFT                       |              | <b>\$1,947</b>  |
|   | 600-2436BR             | BRIDGE RETURN   |              | <b>\$619</b>    |
|   | 600-2472CT-A           | 24" CONNECTOR TOP W/ A GABLES                         |              | <b>\$913</b>    |
|   | 600-1930LFX            | LATERAL FILE - NO TOP                                 |              | <b>\$1,053</b>  |
|   | 600-4372HHD*           | HUTCH W/ HINGED DOORS                                 |              | <b>\$1,740</b>  |
|   | 600-7224CUFWR-24       | WARDROBE STORAGE                                      |              | <b>\$2,615</b>  |
|   | 600-4372TB             | TACK BOARD FOR 43" HUTCHES                            |              | <b>\$387</b>    |
|   | 100-AKTM-2             | ARTICULATING KEYBOARD TRAY                            |              | <b>\$275</b>    |
|   |                        | <b>TOTAL</b>  |              | <b>\$9,549</b>  |
| * IMAGE SHOWS OPTIONAL VALENCE. ADD -V TO SKU AND \$218 TO PRICE IF VALENCE IS REQUIRED |                        |   |              |                 |
|   | <b>LAYOUT #26</b>      |   |              |                 |
|   | 600-MB7248CMD          | BOW TOP CORNER MODULE DESK LEFT                       |              | <b>\$2,476</b>  |
|   | 600-2442BR             | BRIDGE RETURN   |              | <b>\$657</b>    |
|   | 600-2472CT-A           | 24" CONNECTOR TOP W/ A GABLES                         |              | <b>\$913</b>    |
|   | 600-1936UFLX           | LATERAL BBF COMBO - NO TOP                            |              | <b>\$1,405</b>  |
|   | 600-LF2072C            | CREDENZA LATERAL FILE/CABINET                         |              | <b>\$2,541</b>  |
|   | 600-4372HHD*           | HUTCH W/ HINGED DOORS                                 |              | <b>\$1,740</b>  |
|   | 600-4372TB             | TACK BOARD FOR 43" HUTCHES                            |              | <b>\$387</b>    |
|   |                        | <b>TOTAL</b>  |              | <b>\$10,119</b> |
| * IMAGE SHOWS OPTIONAL VALENCE. ADD -V TO SKU AND \$218 TO PRICE IF VALENCE IS REQUIRED |                        |   |              |                 |
|   | <b>LAYOUT #27</b>      |   |              |                 |
|   | 600-MB4272DS           | BOW TOP DESK SHELL                                    |              | <b>\$1,973</b>  |
|   | 600-2448BR             | BRIDGE RETURN   |              | <b>\$665</b>    |
|   | 600-2072CT-A           | 20" CONNECTOR TOP W/ A GABLES                         |              | <b>\$913</b>    |
|   | 600-2036LF             | LATERAL FILE  |              | <b>\$1,269</b>  |
|   | 600-19FPUFX            | FREESTANDING PEDESTAL - NO TOP                        |              | <b>\$871</b>    |
|   | 600-1730COX            | OPEN CABINET - NO TOP                                 |              | <b>\$792</b>    |
|   |                        |   | <b>TOTAL</b> |                 |
|   | <b>LAYOUT #28</b>      |   |              |                 |
|   | OUT2-1272SCTA-L        | SHAPED CORNER TRANSACTION TOP- LT                     |              | <b>\$605</b>    |
|   | OUT2-1272SCTA-R        | SHAPED CORNER TRANSACTION TOP- RT                     |              | <b>\$605</b>    |
|   | 600-7236CM-B           | EXTENDED CORNER MODULE LEFT                           |              | <b>\$1,332</b>  |
|   | 600-2436BR             | BRIDGE RETURN   |              | <b>\$619</b>    |
|   | 600-2072CT-A           | 24" CONNECTOR TOP W/ A GABLES                         |              | <b>\$913</b>    |
|   | OUT2-7036CLF-20-AGD-FR | TALL CABINET OVER LATERAL FILE<br><i>AGD UPCHARGE</i> |              | <b>\$2,678</b>  |
|   | OUT2-4172HHD-AGD-FR    | HUTCH W/ ALUMINUM GLASS DOORS<br><i>AGD UPCHARGE</i>  |              | <b>\$1,574</b>  |
|   | OUT-1272PYP            | 12" POLYCARBONATE PANEL                               | X2           | <b>\$545</b>    |
|   | OUT-12POST             | OUTLINES POST PACKAGE                                 | X4           | <b>\$94</b>     |
|   | OUT-1218PYP-F          | 12" POLYCARBONATE PANELS W/ FILLER                    |              | <b>\$206</b>    |
|   | OUT-2472TBP            | 24" TACKBOARD PANEL                                   |              | <b>\$586</b>    |
|   | OUT-12PYP-HFP          | POLYCARBONATE HUTCH FILLER PANEL                      |              | <b>\$178</b>    |
|   | 600-19FPUFX            | FREESTANDING PEDESTAL - NO TOP                        |              | <b>\$871</b>    |
| 100-KD28  | KEYBOARD DRAWER        |   | <b>\$202</b> |                 |
|   |                        | <b>TOTAL</b>  |              | <b>\$13,582</b> |



|  | ITEMS  | ITEM DESCRIPTION                                       | QTY | 388/600 LIST     |
|--|--|--|-----|------------------|
|  | <b>LAYOUT #29 (SHOWN IN 600 SERIES BROCHURE)</b> |  |     |                  |
|  | 600-3684DSM-3                                    | CENTER MODESTY DESK SHELL                              |     | \$1,525          |
|  | 600-2924CSL                                      | SQUARE CORNER SHELF LEFT                               |     | \$667            |
|  | 600-2436BBOLF                                    | OPEN LATERAL FILE/BOX/BOX COMBO STORAGE                |     | \$1,625          |
|  | 600-2436C-AGD-FR                                 | DOUBLE DOOR CABINET<br><i>AGD UPGRADE</i>              |     | \$1,115<br>\$572 |
|  | 600-2436OBBLF                                    | OPEN LATERAL FILE/BOX/BOX COMBO STORAGE                |     | \$1,511          |
|  | 600-2924CSR                                      | SQUARE CORNER SHELF RIGHT                              |     | \$667            |
|  | 600-4316HSCSL                                    | HUTCH SQUARE CORNER SHELF - LEFT                       |     | \$609            |
|  | 600-4316HSCSR                                    | HUTCH SQUARE CORNER SHELF - RIGHT                      |     | \$609            |
|  | 600-4336DTSHD-AGD-FR                             | DESKTOP STORAGE W/ HINGED DOORS<br><i>AGD UPCHARGE</i> | X2  | \$1,113<br>\$629 |
|  | 600-4336DTS                                      | DESKTOP OPEN STORAGE                                   |     | \$804            |
|  | <b>TOTAL \$13,188</b>                            |  |     |                  |

|  |  |                                      |  |         |
|--|--|--------------------------------------|--|---------|
|  | <b>LAYOUT #30 (SHOWN IN 600 SERIES BROCHURE)</b> |                                      |  |         |
|  | 600-3066RBT                                      | RECTANGULAR BULLET TOP               |  | \$970   |
|  | 600-2436CO                                       | OPEN CABINET                         |  | \$1,050 |
|  | 600-4336DTC                                      | DESKTOP CABINET                      |  | \$1,113 |
|  | 600-1872OSFD                                     | OVERHEAD STORAGE - FLIPPER DOOR      |  | \$1,436 |
|  | 600-2472CT-A                                     | 24" CONNECTOR TOP W/ A GABLES        |  | \$913   |
|  | 600-1936OLFX                                     | OPEN LATERAL FILE STORAGE - NO TOP   |  | \$962   |
|  | 600-7224COCWL-24                                 | WARDROBE STORAGE CABINETS            |  | \$2,216 |
|  | 600-4318DTSHD-L                                  | DESKTOP STORAGE W/ HINGED DOOR LEFT  |  | \$765   |
|  | 600-4336DTS                                      | DESKTOP OPEN STORAGE                 |  | \$804   |
|  | 600-4318DTSHD-R                                  | DESKTOP STORAGE W/ HINGED DOOR RIGHT |  | \$765   |
|  | 600-C2072C                                       | CABINET CREDENZA                     |  | \$2,210 |
|  | <b>TOTAL \$13,204</b>                            |                                      |  |         |

\* IMAGE SHOWS OPTIONAL VALENCE. ADD -V TO SKU AND \$218 TO PRICE IF VALENCE IS REQUIRED

|  |  |                                 |    |         |
|--|--|---------------------------------|----|---------|
|  | <b>LAYOUT #31 (SHOWN IN 600 SERIES BROCHURE)</b> |                                 |    |         |
|  | 600-8442RCMBTM5                                  | CORNER MODULE BULLET W/ 5" LEG  |    | \$2,417 |
|  | 600-2448CT-C                                     | 24" CONNECTOR TOP W/ C GABLES   |    | \$766   |
|  | 600-2472UF                                       | SINGLE RIGHT PEDESTAL CREDENZA  |    | \$1,916 |
|  | 600-1872OSFD                                     | OVERHEAD STORAGE - FLIPPER DOOR |    | \$1,436 |
|  | 600-7216COF-R-24                                 | STORAGE CABINET                 |    | \$1,650 |
|  | 388-1836DTO                                      | DESKTOP ORGANIZER               |    | \$603   |
|  | OUT-1824TBP-F                                    | 18" TACK BOARD PANEL            |    | \$285   |
|  | OUT-1848PYP-F                                    | 18" POLYCARBONATE PANEL         |    | \$435   |
|  | OUT-1242PYP                                      | 12" POLYCARBONATE PANEL         |    | \$323   |
|  | OUT-18POST                                       | 18" OUTLINES POST PACKAGE       | X5 | \$113   |
|  | OUT-12POST                                       | OUTLINES POST PACKAGE           |    | \$94    |
|  | <b>TOTAL \$10,490</b>                            |                                 |    |         |

\* IMAGE SHOWS OPTIONAL VALENCE. ADD -V TO SKU AND \$218 TO PRICE IF VALENCE IS REQUIRED

\*\*LAYOUT SHOWS NON-FLUTED EDGE. PLEASE INDICATED ON YOUR PO IF FLUTING IS NOT REQUIRED

# 388/600 SERIES LAYOUTS

|  | ITEMS  | ITEM DESCRIPTION                                     | QTY          | 388/600 LIST                   |
|--|--|--|--------------|--------------------------------|
|  | <b>LAYOUT #32 (SHOWN IN 600 SERIES BROCHURE)</b> |  |              |                                |
|  | 600-S3672DS-AGM                                  | STRAIGHT DESK SHELL W/ EXTENDED PEDESTALS            |              | <b>\$2,230</b>                 |
|  | 600-2448UF                                       | PEDESTAL RETURN                                      |              | <b>\$1,382</b>                 |
|  | 600-7724CLC-L-24                                 | SINGLE DOOR CLOSET CABINET                           |              | <b>\$2,179</b>                 |
|  | 600-UF2472CFF                                    | CREDENZA   |              | <b>\$2,560</b>                 |
|  | 600-1872OSHD-AGD-FR                              | OVERHEAD STORAGE - HINGED DOOR<br><i>AGD UPGRADE</i> |              | <b>\$1,471</b><br><b>\$893</b> |
|  | 600-7724SCSR                                     | FREESTANDING SQUARE CORNER SHELVES                   |              | <b>\$1,313</b>                 |
|  | 920-R54  | 53 1/4" ROUND TOP                                    |              | <b>\$1,041</b>                 |
|  | 900-CROSS36                                      | CROSS BASE   |              | <b>\$281</b>                   |
|  |  |  | <b>TOTAL</b> |                                |

\* IMAGE SHOWS OPTIONAL VALENCE. ADD -V TO SKU AND **\$218** TO PRICE IF VALENCE IS REQUIRED

|         |  |                                    |              |                |
|---------|--|------------------------------------|--------------|----------------|
|         | <b>LAYOUT #33 (SHOWN IN 600 SERIES BROCHURE)</b> |                                    |              |                |
|         | 600-FR3684JCM-B                                  | J TOP RIGHT EXTENDED CORNER MODULE |              | <b>\$1,668</b> |
|         | 600-2448BR                                       | BRIDGE RETURN                      |              | <b>\$665</b>   |
|         | 600-2484CT-A                                     | 24" CONNECTOR TOP                  |              | <b>\$1,190</b> |
|         | 600-19FPUFX                                      | FREESTANDING PEDESTAL - NO TOP     |              | <b>\$871</b>   |
|         | 600-1848OS                                       | OPEN OVERHEAD STORAGE              |              | <b>\$748</b>   |
|         | 600-3618DTC-L                                    | DESKTOP CABINET - HINGED LEFT      |              | <b>\$692</b>   |
|         | 600-3618DTC-R                                    | DESKTOP CABINET - HINGED RIGHT     |              | <b>\$692</b>   |
|         | C388-1848DTO                                     | DESKTOP ORGANIZER                  |              | <b>\$737</b>   |
|         | 600-6524OFFWL-24                                 | OPEN WARDROBE STORAGE              |              | <b>\$2,109</b> |
| 100-MA2 | PNEUMATIC LCD DUAL MONITOR ARM                   |                                    | <b>\$436</b> |                |
| 100-KTM | KEYBOARD TRAY                                    |                                    | <b>\$169</b> |                |
|         |  | <b>TOTAL</b>                       |              | <b>\$9,977</b> |

\* IMAGE SHOWS OPTIONAL VALENCE. ADD -V TO SKU AND **\$218** TO PRICE IF VALENCE IS REQUIRED

\*\*LAYOUT SHOWS NON-FLUTED EDGE. PLEASE INDICATED ON YOUR PO IF FLUTING IS **NOT** REQUIRED

|               |  |  |              |                 |
|---------------|--|--|--------------|-----------------|
|               | <b>LAYOUT #34 (SHOWN IN 600 SERIES BROCHURE)</b> |  |              |                 |
|               | 600-3060RBTG                                     | RECTANGULAR BULLET TOP W/ FULL GABLE & 3" SQUARE LEG |              | <b>\$937</b>    |
|               | 600-2442CT-C                                     | 24" CONNECTOR TOP                                    |              | <b>\$727</b>    |
|               | 600-2442CM-C                                     | CORNER MODULE  |              | <b>\$1,109</b>  |
|               | 600-2448CT-B                                     | 24" CONNECTOR TOP                                    | X2           | <b>\$766</b>    |
|               | 600-19FPUFX                                      | FREESTANDING PEDESTAL - NO TOP                       | X2           | <b>\$871</b>    |
|               | 600-4724OCWR-24                                  | OPEN SHELF/CABINET/WARDROBE RIGHT                    |              | <b>\$1,538</b>  |
|               | 600-4724OCWL-24                                  | OPEN SHELF/CABINET/WARDROBE LEFT                     |              | <b>\$1,538</b>  |
|               | 600-4272CM-B                                     | CORNER MODULE EXTENDED RIGHT                         |              | <b>\$1,620</b>  |
|               | OUT2-1272TA                                      | STRAIGHT TRANSACTION TOPS                            |              | <b>\$443</b>    |
|               | 600-1848DTO                                      | DESKTOP ORGANIZER                                    | X2           | <b>\$737</b>    |
|               | OUT-1272PLX-F-FR                                 | 12" PLEXIGLASS PANEL W/ FILLER                       | X2           | <b>\$555</b>    |
|               | OUT-1242PLX-FR                                   | 12" PLEXIGLASS PANEL                                 |              | <b>\$325</b>    |
|               | OUT-1242TBP                                      | 12" TACKBOARD PANEL                                  |              | <b>\$338</b>    |
|               | OUT-0642PLX-CL                                   | 6" TOP PANEL CLEAR                                   | X2           | <b>\$325</b>    |
|               | OUT-0672PLX-F-CL                                 | 6" TOP PANEL CLEAR W/ FILLER                         |              | <b>\$555</b>    |
| OUT-12POST-BL | POST PACKAGE                                     | X2   | <b>\$94</b>  |                 |
| OUT-18POST-BL | POST PACKAGE                                     | X5   | <b>\$113</b> |                 |
|               |  | <b>TOTAL</b>   |              | <b>\$16,391</b> |

\*\*LAYOUT SHOWS NON-FLUTED EDGE. PLEASE INDICATED ON YOUR PO IF FLUTING IS **NOT** REQUIRED

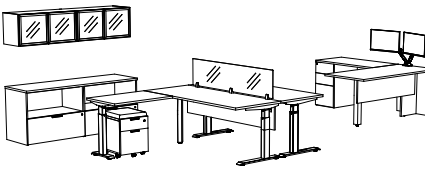
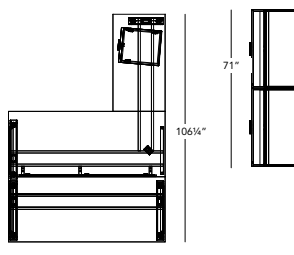
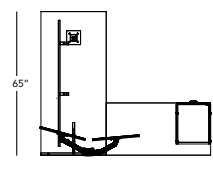
|  | ITEMS  | ITEM DESCRIPTION                                   | QTY       | 388/600 LIST     |
|--|--|--|-----------|------------------|
| <br><br> | <b>LAYOUT #35 (SHOWN IN 388 SERIES BROCHURE)</b> |  |           |                  |
|  | 388-1972FC                                       | FILE CABINET TOP                                   |           | \$361            |
|  | 388-1936OLFX                                     | OPEN LATERAL FILE STORAGE - NO TOP                 | X2        | \$962            |
|  | 388-1872OSHD-AGD-FR                              | OVERHEAD STORAGE WITH HINGED DOORS<br>AGD UPCHARGE |           | \$1,290<br>\$893 |
|  | CAL-E1-2LEG                                      | STRAIGHT ELECTRIC HEIGHT ADJUSTABLE 2 LEG BASE     |           | \$1,364          |
|  | CAL-E1-3LEG                                      | L SHAPED ELECTRIC HEIGHT ADJUSTABLE 3 LEG BASE     |           | \$1,988          |
|  | 388-1622MPF                                      | MOBILE B/F PEDESTAL                                |           | \$834            |
|  | WRK-MPEDCUSH-ESC                                 | USE ON 21" HIGH MOBILE PEDESTALS                   |           | \$393            |
|  | 388-3066RBTG                                     | RECTANGULAR BULLET TOP                             |           | \$888            |
|  | 388-19FPUFX                                      | FREESTANDING PEDESTAL - NO TOP                     |           | \$871            |
|  | FLXS-REC2448                                     | 24" RECTANGLE TOP                                  |           | \$246            |
|  | CAL-REC3072                                      | 30" RECTANGLE TOP                                  | X2        | \$453            |
|  | CAL-RS2448                                       | 24" RETURN TOP                                     |           | \$246            |
|  | CAL-MP1866LAP                                    | 18" LAMINATE MODESTY PANELS                        | X2        | \$282            |
|  | TM1-1566PLX                                      | 15" TOP MOUNT PLEXIGLASS PRIVACY PANEL             |           | \$546            |
| 100-MA2  | PNEUMATIC LCD DUAL MONITOR ARM                   |  | \$436     |                  |
| WRK-WFBK   | WORK SURFACE FLUSH BRACKET KIT                   | X2   | \$36      |                  |
|  | <b>TOTAL</b>                                     |  | <b>X2</b> | <b>\$13,822</b>  |

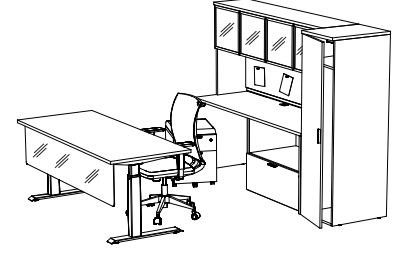
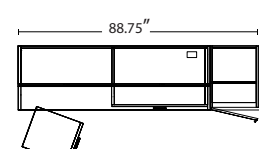
|   |  |  |  |                  |
|---|--|--|--|------------------|
| <br><br> | <b>LAYOUT #36 (SHOWN IN 388 SERIES BROCHURE)</b> |  |  |                  |
|   | 388-2472CT-A                                     | 24" CONNECTOR TOP                              |  | \$801            |
|   | 388-3672HHD-AGD-FR                               | 36" HUTCH W/ DOORS & DIVIDER<br>AGD UPCHARGE   |  | \$1,393<br>\$893 |
|   | 388-3672TB                                       | TACK BOARD FOR 36" HUTCHES                     |  | \$357            |
|   | 388-1936OLFX                                     | OPEN LATERAL FILE STORAGE - NO TOP             |  | \$962            |
|   | 388-1622MPF                                      | MOBILE B/F PEDESTAL                            |  | \$834            |
|   | WRK-MPEDCUSH-ESC                                 | USE ON 21" HIGH MOBILE PEDESTALS               |  | \$393            |
|   | CAL-E1-2LEG                                      | STRAIGHT ELECTRIC HEIGHT ADJUSTABLE 2 LEG BASE |  | \$1,364          |
|   | CAL-REC3072                                      | 30" RECTANGLE TOP                              |  | \$453            |
|   | CAL-MP1660PLX                                    | 16" PLEXIGLASS HANGING MODESTY PANEL           |  | \$491            |
|   | 388-6518CLC-L-24                                 | SINGLE DOOR CLOSET CABINET                     |  | \$1,862          |
|   | ECO-MB   | ECHO MID-BACK CHAIR                            |  | \$607            |
|   |  | <b>TOTAL</b>                                   |  | <b>\$10,410</b>  |

# 388/600 SERIES LAYOUTS

| ITEMS  | ITEM DESCRIPTION         | QTY                                    | 388/600 LIST    |
|--|--------------------------|--|-----------------|
| <b>LAYOUT #37 (SHOWN IN 388 SERIES BROCHURE)</b> |                          |  |                 |
|  | <b>388-2424MT</b>        | MAGAZINE TABLE                         | <b>\$398</b>    |
|  | <b>600-2484SCT-42</b>    | BAR HEIGHT 24" SHARED COMMUNITY TABLES | <b>\$1,650</b>  |
|  | <b>600-2466SCT</b>       | 24" SHARED COMMUNITY TABLES            | <b>\$1,014</b>  |
|  | <b>OUT-648PLX-NAPS-F</b> | NEO-ANGLE CORNER PANEL SETS            | <b>\$834</b>    |
|  | <b>OUT1-1248NATA</b>     | NEO-ANGLE TRANSACTION TOPS             | <b>\$534</b>    |
|  | <b>388-2448NACM</b>      | NEO-ANGLE CORNER MODULE                | <b>\$1,325</b>  |
|  | <b>OUT-1236PLX</b>       | 12" PLEXIGLASS PANEL                   | <b>\$299</b>    |
|  | <b>OUT-1248PLX</b>       | 12" PLEXIGLASS PANEL                   | <b>\$400</b>    |
|  | <b>OUT1-1236TA</b>       | STRAIGHT TRANSACTION TOP               | <b>\$179</b>    |
|  | <b>OUT1-1248TA</b>       | STRAIGHT TRANSACTION TOP               | <b>\$234</b>    |
|  | <b>OUT-12POST</b>        | OUTLINES POST PACKAGE                  | X4 <b>\$94</b>  |
|  | <b>OUT-6POST</b>         | 6" OUTLINES POST PACKAGE               | X4 <b>\$94</b>  |
|  | <b>388-2448CT-B</b>      | 24" CONNECTOR TOP                      | <b>\$672</b>    |
|  | <b>388-2436CT-B</b>      | 24" CONNECTOR TOP                      | <b>\$615</b>    |
|  | <b>388-2436O2LF4</b>     | OPEN TALL LATERAL FILE STORAGE         | <b>\$2,185</b>  |
| <b>TOTAL</b>                                     |                          |  | <b>\$11,091</b> |

|                   |                           |  |                 |
|-------------------|---------------------------|--|-----------------|
| <b>LAYOUT #38</b> |                           |  |                 |
|                   | <b>388-1836OSH</b>        | OVERHEAD STORAGE W/ HINGED DOORS               | <b>\$782</b>    |
|                   | <b>388-6530COUFWR-24</b>  | CABINET/OPEN SHELF/BOX/BOX/FILE/WARDROBE RIGHT | <b>\$2,139</b>  |
|                   | <b>388-2436DC</b>         | DRAWERS OVER DOUBLE DOOR CABINETS              | <b>\$1,368</b>  |
|                   | <b>388-3636TB</b>         | TACK BOARD                                     | <b>\$237</b>    |
|                   | <b>CAL-E1-3LEG</b>        | L SHAPED ELECTRIC HEIGHT ADJUSTABLE 3 LEG BASE | <b>\$1,988</b>  |
|                   | <b>CAL-3072-7224RCMLD</b> | ONE PIECE L-SHAPE TOP                          | <b>\$1,364</b>  |
|                   | <b>TM1-1572PLX</b>        | 15" TOP MOUNT PLEXIGLASS PRIVACY PANEL         | <b>\$605</b>    |
|                   | <b>CAL-MP1672PLX</b>      | 16" PLEXIGLASS HANGING MODESTY PANEL           | <b>\$538</b>    |
|                   | <b>900-LOOP30</b>         | 30" METAL LOOP LEG                             | X2 <b>\$207</b> |
|                   | <b>FLXS-REC3054</b>       | 30" RECTANGLE TOPS                             | <b>\$337</b>    |
|                   | <b>388-6524OWL-24</b>     | OPEN SHELVES/WARDROBE LEFT                     | <b>\$1,408</b>  |
|                   | <b>388-1848OSH</b>        | OVERHEAD STORAGE W/ HINGED DOORS               | <b>\$896</b>    |
|                   | <b>388-2448CT-B</b>       | 24" CONNECTOR TOP                              | <b>\$672</b>    |
|                   | <b>388-19FPUFX</b>        | FREESTANDING PEDESTAL - NO TOP                 | <b>\$871</b>    |
|                   | <b>388-4348TB</b>         | TACK BOARD FOR 43" HUTCHES                     | <b>\$353</b>    |
|                   | <b>CAL-E1-2LEG</b>        | STRAIGHT ELECTRIC HEIGHT ADJUSTABLE 2 LEG BASE | <b>\$1,364</b>  |
|                   | <b>CCAL-RCM2442-7230</b>  | RH EXTENDED CORNER MODULE TOPS                 | <b>\$734</b>    |
|                   | <b>CAL-E1-2LEG-CMF</b>    | CORNER MODULE FOOT                             | <b>\$212</b>    |
| <b>TOTAL</b>      |                           |  | <b>\$16,282</b> |

| ITEMS             | ITEM DESCRIPTION                       | QTY | 388/600 LIST    |
|-------------------|--|-----|-----------------|
| <b>LAYOUT #39</b> |  |     |                 |
| FLXS-REC2448      | 24" RECTANGLE TOP                      |     | \$246           |
| 900-LOOP24        | METAL LOOP LEGS                        |     | \$188           |
| CAL-MP1642PLX     | 16" PLEXIGLASS HANGING MODESTY PANEL   |     | \$346           |
| FLXS-REC3072      | 30" RECTANGLE TOPS                     | X6  | \$437           |
| 900-LOOP30        | 30" METAL LOOP LEG                     | X8  | \$207           |
| WRK-WFBK          | WORK SURFACE FLUSH BRACKET KIT         |     | \$36            |
| CAL-MP1666PLX     | 16" PLEXIGLASS HANGING MODESTY PANEL   | X2  | \$511           |
| CAL-MP1672PLX     | 16" PLEXIGLASS HANGING MODESTY PANEL   |     | \$538           |
| 388-1872OSHD      | OVERHEAD STORAGE WITH HINGED DOORS     |     | \$1,290         |
| 388-1236VC        | VERTICAL CUBBY-HOLE                    |     | \$384           |
| 388-6518CLC-L-24  | SINGLE DOOR CLOSET CABINET             |     | \$1,862         |
| 388-6536BK        | BOOKCASE                               |     | \$868           |
| 388-19FPUFX       | FREESTANDING PEDESTAL - NO TOP         | X4  | \$871           |
| TM1-1572PLX       | 15" TOP MOUNT PLEXIGLASS PRIVACY PANEL |     | \$605           |
| TM1-1572TBP       | 15" TOP MOUNT TACK BOARD PRIVACY PANEL | X2  | \$731           |
| <b>TOTAL</b>      |  |     | <b>\$16,609</b> |

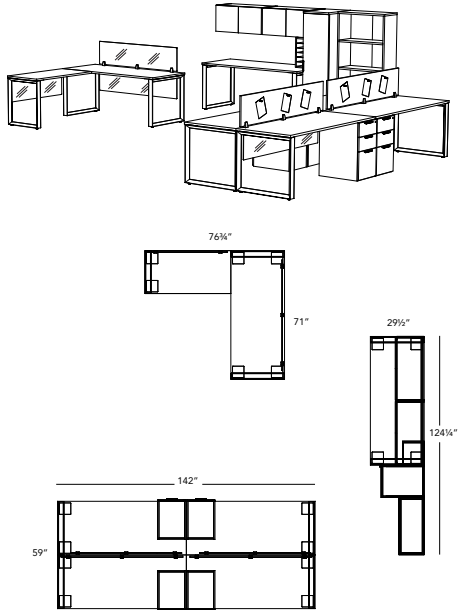

|                   |                              |    |                |
|-------------------|------------------------------|----|----------------|
| <b>LAYOUT #40</b> |                              |    |                |
| 388-3666H         | 36" OPEN HUTCH               |    | \$840          |
| 388-3666CM        | CORNER MODULE EXTENDED RIGHT |    | \$1,113        |
| 388-2430RS        | NON-HANDED RETURN SHELL      |    | \$576          |
| 388-3066DS        | 66" DESK SHELL               |    | \$837          |
| 388-2436RS        | NON-HANDED RETURN SHELL      |    | \$598          |
| 388-HPF           | BOX/FILE HANGING PEDESTAL    | X2 | \$752          |
| 100-AKTM-2        | ARTICULATING KEYBOARD TRAY   |    | \$275          |
| 100-KD28          | KEYBOARD DRAWER              |    | \$202          |
| 900-XB26          | LAMINATE CROSS BASE          |    | \$446          |
| 910-R42           | 42" ROUND TOP                |    | \$484          |
| <b>TOTAL</b>      |                              |    | <b>\$6,875</b> |

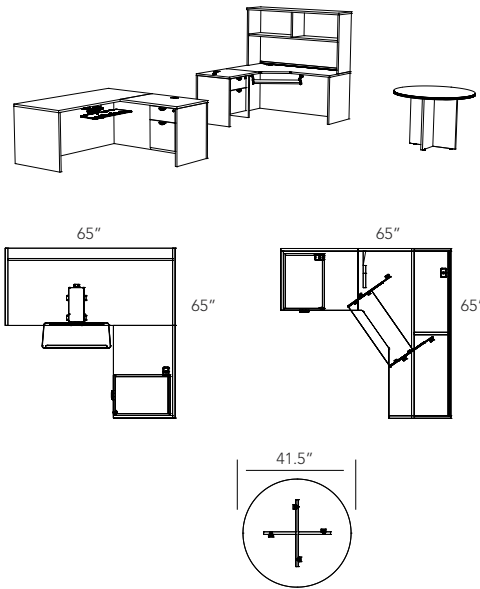

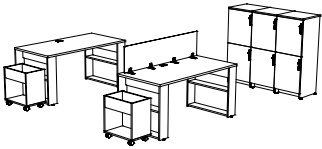
|  | ITEMS             | ITEM DESCRIPTION                                 | QTY | 388/600 LIST   |
|--|-------------------|--|-----|----------------|
|  | <b>LAYOUT #41</b> |  |     |                |
|  | LEV-3060TBL-SOX2  | 30" DEEP TABLE W/ 2 X SHELF OPEN                 | X2  | <b>\$1,002</b> |
|  | 388-1320MSO-22    | MOBILE STORAGE OPEN                              | X2  | <b>\$743</b>   |
|  | FS1-1560PLX       | 15" FREE STANDING PLEXIGLASS PRIVACY PANEL       |     | <b>\$536</b>   |
|  | LOC-6518CLH2-18   | 65" TALL - LEFT HINGE, SINGLE WIDE 2 DOOR LOCKER | X3  | <b>\$1,664</b> |
|  |                   | <b>TOTAL</b>                                     |     | <b>\$9,018</b> |

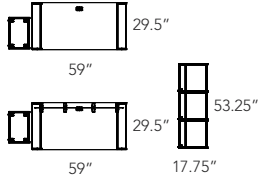

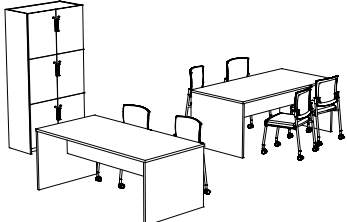
|  |                   |                                  |              |                |
|--|-------------------|----------------------------------|--------------|----------------|
|  | <b>LAYOUT #42</b> |                                  |              |                |
|  | LOC-7236C6-18     | 72" TALL - 2 WIDE, 3 DOOR LOCKER |              | <b>\$2,984</b> |
|  | 388-3672SCT       | SHARED COMMUNITY TABLE           | X2           | <b>\$1,131</b> |
|  |                   |                                  | <b>TOTAL</b> | <b>\$5,246</b> |

*SHOWN WITH DUNE CHAIRS*

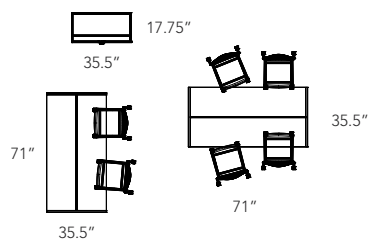

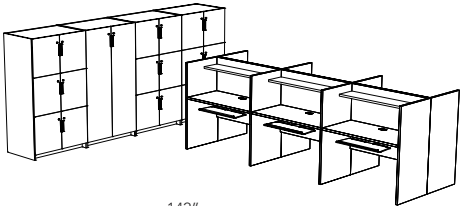
|  |                   |   |    |                 |
|--|-------------------|---|----|-----------------|
|  | <b>LAYOUT #43</b> |   |    |                 |
|  | TEM-2448GSC-48-2S | 48" WIDE GANGED STUDY CARREL W/ ½ HEIGHT BACK & SHELF | X6 | <b>\$1,158</b>  |
|  |                   | <i>SHELF UPCHARGE</i>                                 | X6 | <b>\$128</b>    |
|  | 100-AKTM-2        | ARTICULATING KEYBOARD TRAY                            | X6 | <b>\$275</b>    |
|  | LOC-6536C2-24     | 65" TALL - 2 WIDE, SINGLE DOOR LOCKER                 |    | <b>\$2,846</b>  |
|  | LOC-6536C6-24     | 65" TALL - 2 WIDE, 3 DOOR LOCKER                      | X3 | <b>\$3,046</b>  |
|  |                   | <b>TOTAL</b>  |    | <b>\$21,350</b> |

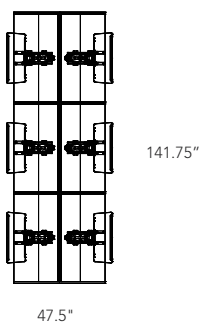
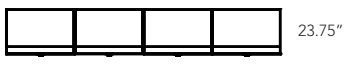

# LEVELS SERIES

This is a metric series (imperial sizing available). Please refer to page [INDEX-1](#) for details

|  |                         |
|--|-------------------------|
| <b>Series Specifications &amp; Description</b> .....                     | <a href="#">LEV-3</a>   |
| <b>Product by Category</b> .....   |                         |
| <b>Metal Leg Desking</b> .....   |                         |
| Rectangular Bullet Returns .....   | <a href="#">LEV-8</a>   |
| Tiered Rectangular Bullet Returns .....                                  | <a href="#">LEV-9</a>   |
| Metal Leg Tables .....   | <a href="#">LEV-11</a>  |
| Height Adjustable Desks .....  | <a href="#">LEV-14</a>  |
| <b>Laminate Desking</b> .....  |                         |
| Desk Shells .....  | <a href="#">LEV-15</a>  |
| Desk Shells with Extended Pedestals .....                                | <a href="#">LEV-16</a>  |
| Bridge Returns .....   | <a href="#">LEV-17</a>  |
| Return Shells .....  | <a href="#">LEV-17</a>  |
| Connector Tops .....   | <a href="#">LEV-18</a>  |
| Extended Corner Modules .....  | <a href="#">LEV-19</a>  |
| Peninsula Tops .....   | <a href="#">LEV-20</a>  |
| <b>Modesty   Divider Panels</b> .....                                    | <a href="#">LEV-24</a>  |
| <b>Drawer Pedestals</b> .....  |                         |
| Hanging Pedestal .....   | <a href="#">LEV-26</a>  |
| Mobile Pedestal .....  | <a href="#">LEV-26</a>  |
| Mobile Open Storage .....  | <a href="#">LEV-27</a>  |
| Metal Mobile Pedestals .....   | <a href="#">LEV-27</a>  |
| Freestanding Pedestals - No Top .....                                    | <a href="#">LEV-28</a>  |
| Freestanding Pedestals .....   | <a href="#">LEV-30</a>  |
| <b>Credenzas</b> .....   |                         |
| Desk Height Cabinet Credenzas .....                                      | <a href="#">LEV-32</a>  |
| Desk Height Cabinet Credenzas with Storage Risers .....                  | <a href="#">LEV-33</a>  |
| Low Height Cabinet Credenzas .....                                       | <a href="#">LEV-113</a> |
| Credenza Cushions .....  | <a href="#">LEV-39</a>  |
| <b>Storage Cabinets</b> .....  |                         |
| Lateral File Storage .....   | <a href="#">LEV-39</a>  |
| Cabinet Storage (Includes Desk Height & Low Height Cabinets) .....       | <a href="#">LEV-45</a>  |
| Open Storage Cabinets (Includes Desk Height & Low Height Cabinets) ..... | <a href="#">LEV-55</a>  |
| <b>File Cabinet Tops   Common Tops</b> .....                             | <a href="#">LEV-60</a>  |

**continued...**

|   |         |
|---|---------|
| <b>Mid-Height Storage Returns</b> .....                         |         |
| Closet Cabinet Returns .....                                    | LEV-62  |
| Cabinet Storage Returns .....                                   | LEV-63  |
| Wardrobe Returns .....  | LEV-65  |
| <b>Mid-Height Storage</b> .....                                 |         |
| Cabinet Storage .....   | LEV-69  |
| Open Storage .....  | LEV-70  |
| Closet Cabinet Storage .....                                    | LEV-71  |
| Wardrobe Storage .....  | LEV-71  |
| <b>Tall Storage</b> .....                                       |         |
| Cabinet Storage .....   | LEV-76  |
| Single Door Cabinet Storage .....                               | LEV-78  |
| Combo Cabinet Storage .....                                     | LEV-79  |
| Wardrobe Storage .....  | LEV-81  |
| <b>Bookcases</b> .....  | LEV-89  |
| <b>Stacking Storage</b> .....                                   |         |
| Stacking Bookcase .....   | LEV-90  |
| Stacking Hinged Door Cabinet .....                              | LEV-91  |
| <b>Hutches &amp; Accessories</b> .....                          |         |
| Laminate Hutches .....  | LEV-93  |
| Laminate Hutches with Plexi Bi-Pass or Sliding Doors .....      | LEV-97  |
| Tackboards .....  | LEV-98  |
| Metal Support Hutches .....                                     | LEV-99  |
| Metal Support Hutches with Plexi Bi-Pass or Sliding Doors ..... | LEV-102 |
| Open Divider Hutches .....                                      | LEV-104 |
| <b>Desktop Organizers   Mail Sorts</b> .....                    | LEV-106 |
| <b>Overhead Storage</b> .....                                   |         |
| Open Overhead Storage .....                                     | LEV-107 |
| Overhead Storage with Hinged Doors .....                        | LEV-107 |
| Overhead Storage with Plexi Bi-Pass or Sliding Doors .....      | LEV-109 |
| <b>Corner Shelves</b> .....                                     |         |
| Hutch Corner Shelves .....                                      | LEV-110 |
| Desk Height Corner Shelves .....                                | LEV-113 |
| Tall Corner Shelves .....                                       | LEV-111 |
| <b>Flip Top Storage Benches &amp; Cushions</b> .....            | LEV-112 |
| <b>Tables</b> .....   |         |
| Shared Community Tables .....                                   | LEV-113 |
| Magazine Tables .....   | LEV-115 |
| <b>LEVELS Series Layouts</b> .....                              | LEV-116 |

**NOTE:** Information is current at time of print. For up to date information check online at [www.heartwood.ca](http://www.heartwood.ca).



## Features

- ♥ Modern, layered aesthetic for contemporary office design
- ♥ Optional 7" contemporary storage riser feet available
- ♥ Tops have metal to metal connection – where applicable
- ♥ Over 800 components per series and ≈20 finishes to choose from.
- ♥ Two-tone combinations available at no extra charge.
- ♥ Any handle style available at no extra charge - default bar handle
- ♥ Soft close hinges are standard
- ♥ Compatible with HDL's Levels (default HML Finishes match HDL Levels)

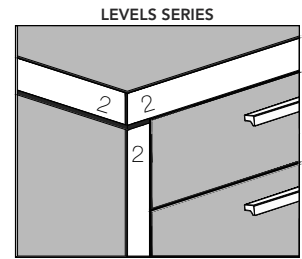

1" TOPS  
Matching 2mm edge band on  
all exposed edges

## Finishes

| LAMINATES |                    | SUITABLE FOR |          |        | DEFAULT FINISHES |                              |                      |              |                 |  |
|-----------|--------------------|--------------|----------|--------|------------------|------------------------------|----------------------|--------------|-----------------|--|
| ABBR      | LAMINATE COLOUR    | 1" TOPS      | 1½" TOPS | BASE   | MATCHING EDGE    | SHADOW STRIP (BLACK DEFAULT) | HANDLES- (BLACK BAR) | LOCK (BLACK) | GROMMET (BLACK) |  |
| AM        | Autumn Maple       | ✓            | ✓        | ✓      | ✓                | ✓                            | ✓                    | ✓            | ✓               |  |
| BL        | Black              | ✗            | ✗        | ✓      | ✓                | ✓                            | ✓                    | ✓            | ✓               |  |
| BW        | Black Walnut       | ✓            | ✓        | ✓      | ✓                | ✓                            | ✓                    | ✓            | ✓               |  |
| CD        | Cappuccino Dream** | ✓            | ✓        | ✓      | ✓                | ✓                            | ✓                    | ✓            | ✓               |  |
| CM        | Charcoal Matrix    | ✓            | ✓        | ✓      | Black            | ✓                            | ✓                    | ✓            | ✓               |  |
| DE        | Desert Sand        | ✓            | ✓        | ✓      | ✓                | Matching                     | ✓                    | ✓            | ✓               |  |
| DD        | Driftwood***       | ✓            | ✓        | ✓ (1") | ✓                | Matching                     | ✓                    | ✓            | ✓               |  |
| DW        | Driftwood Grey**   | ✗            | ✗        | ✓ (¾") | ✓                | Matching                     | ✓                    | ✓            | ✓               |  |
| EZ        | Evening Zen        | ✓            | ✓        | ✓      | ✓                | Silver                       | Aluminium            | ✓            | ✓               |  |
| GA        | Golden Ash         | ✓            | ✓        | ✓      | ✓                | ✓                            | ✓                    | ✓            | ✓               |  |
| GT        | Graphite           | ✗            | ✗        | ✓      | ✓                | ✓                            | ✓                    | ✓            | ✓               |  |
| GR        | Grey               | ✓            | ✓        | ✓      | ✓                | Matching                     | ✓                    | ✓            | ✓               |  |
| GD        | Grey Dusk          | ✓            | ✓        | ✓      | ✓                | ✓                            | Scoop Aluminium      | ✓            | ✓               |  |
| GM        | Grey Matrix        | ✓            | ✓        | ✓      | Grey             | ✓                            | ✓                    | ✓            | ✓               |  |
| HM        | Hardrock Maple     | ✓            | ✓        | ✓      | ✓                | ✓                            | ✓                    | ✓            | ✓               |  |
| NC        | Noce Cocoa         | ✓            | ✓        | ✓      | ✓                | Matching                     | Aluminium            | Silver       | Grey            |  |
| PW        | Pure White         | ✓            | ✓        | ✓      | ✓                | Matching                     | Aluminium            | Silver       | Grey            |  |
| RM        | Royal Mahogany     | ✓            | ✓        | ✓      | ✓                | ✓                            | ✓                    | ✓            | ✓               |  |
| SM        | Sugar Maple        | ✓            | ✓        | ✓      | ✓                | ✓                            | ✓                    | ✓            | ✓               |  |
| SW        | Seaside White      | ✓            | ✓        | ✓      | ✓                | Matching                     | Aluminium            | Silver       | Grey            |  |
| VA        | Volcanic Ash       | ✓            | ✓        | ✓      | ✓                | Matching                     | ✓                    | ✓            | ✓               |  |
| WW        | Winter Wood        | ✓            | ✓        | ✓      | ✓                | Matching                     | Aluminium            | Silver       | Grey            |  |

\*\* Textured Finish

\*\*\* Non-textured Finish 1" & 1½" only

High Pressure (HP) laminate available. Contact Customer Service

## Construction

- ♥ Tops and gables are 1" thick.
- ♥ Modesty panels are ¾" thick.
- ♥ All are thermally fused laminate on a 45lb industrial particleboard core.
- ♥ Leveling glides are standard on all floor models.

## Edge Detail:

- ♥ Edges: LEVELS exposed edges all finished in a matching 2mm edge banding.  
> Banding changes to an alternate Heartwood standard colour are available at no extra charge.
- ♥ Highlight/shadow/matching strip: Highlight/shadow/matching equivalent strip detail below tops on most components - see chart above.

**Metal Legs:**

- ♥ Metal desking available with powder-coated steel Loop Legs - **LOOP** or Square Offset Legs - **SO2**
- ♥ The default leg for peninsula tops is 3" square leg. Other leg options are available, no extra charge:
  - 5" round legs add - RL5 (Black - BL)
  - 2.5" round legs add - RL2.5 (Silver - SL or Black - BL)
- > **Ordering Example:** LEV-3066RBTG-**RL5-BL** for 5" round black leg



**Metal Storage Risers:**

- ♥ Powder-coated steel construction
- ♥ Storage risers include levelers
- ♥ All SKUs with "SR" include SStorage Riser feet



**Metal Hutch Supports:**

- ♥ Powder-coated steel construction



**Drawers:**

- ♥ Laminate units
  - ♥ All drawers are 5 pieces - 4½" black sides & 1 x ⅛" black bottom.
  - ♥ All drawers and doors have handles except hutch doors. Hutch door handles maybe added by request. See page **ACC 100-3** for selection details.
  - ♥ All box and file drawers mounted on full-extension ball bearing slides, 75lb load rating.
  - ♥ Lateral file drawers mounted on full-extension ball bearing slides, 100lb load rating.
  - ♥ Each file drawer features side rails and adjustable file bars that accommodate front-to-back letter or side to side legal sized hanging folders.
  - ♥ One pencil tray included with every box drawer unit.
- NOTE:** All file and lateral file drawers are constructed to support hanging file folders. Broken drawer bottoms are not covered by warranty. If you expect to store heavy items, ie. phone books, paper etc. on the drawer bottom, we offer an optional ½" bottom for these drawers. Please contact Customer Service for pricing.

**Metal Pedestal Drawers:**

- ♥ All drawers are steel, commercial-grade construction.
- ♥ Pedestal drawers have radius drawer fronts.
- ♥ All box & file drawers are mounted on FULL extension ball bearing slides.
- ♥ Each file drawer will hold letter or legal sized hanging folders.
- ♥ Mobile locking casters (heavy-duty)
- ♥ Ships fully assembled

**Grommets:**

Laminate finishes come with different default grommet colours. For alternate colours or custom grommet locations, contact customer service [cs@heartwood.ca](mailto:cs@heartwood.ca)

**Corner Module Profile:**

- ♥ Two standard contour profiles are available for corner module tops:
  - **CM** - traditional cutback
  - **RCM** - Radiused corner module

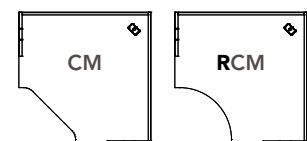

**NOTE:** Does not apply to Neo-angle wedge. For custom shapes contact customer service.

**Extended Corner Module Profiles:**

- ♥ Four standard contour profiles are available for extended corner module tops at no additional upcharge:
  - **CM** - traditional cutback
  - **\*SCM** - Scooped extended corner module
  - **RCM** - Radiused extended corner module
  - **JCM** - J extended corner module

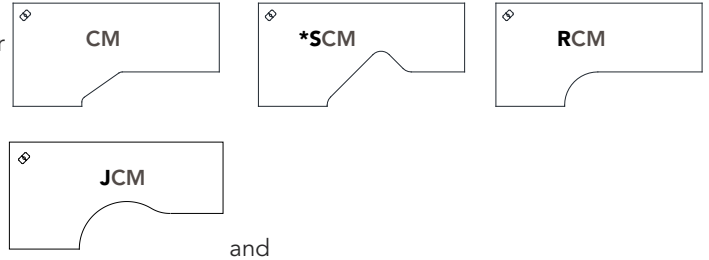

To order simply change the suffix accordingly  
> **Ordering Example:** LEV-3666CM for standard profile  
LEV-3666SCM for scooped corner module profile.

For custom shapes contact customer service.

\* We recommend cutback connecting returns to fit best with **SCM shape** units.

**Gable Sets:**

- ♥ Corner modules, extended corner modules and connector tops must be ordered with the required gable set.

- A:** Gable set comes with 2 wide gables
- B:** Gable set comes with 1 wide and 1 narrow gable
- C:** Gable set comes with 2 narrow gables

> **Ordering Example:** LEV-2472CT-C

- ♥ Unsupported units over 72" require a center support Gable. Add **+C** to Sku and **\$198** to list price.

> **Ordering Example:** LEV-2490CT-B+C

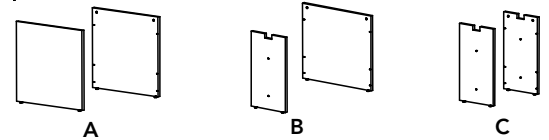

**Modesty Panels:**

- ♥ Flush modesty panels are standard on all corner modules and connector tops.
- ♥ Recessed modesty panels available on request. Standard recess is 2 1/2".
- > **Ordering Example:** (add "R" before unit size) LEV-R2442CM-C
- ♥ 30" desks have a 4" recessed MP; 36" desks have a 10" recessed MP.
- ♥ Other components have flush modesty panels unless otherwise noted.
- ♥ All modesty panels are FULL. 1/2 or 3/4 height MP available at no extra charge on most units.

For 1/2 height modesty add **2** to the Sku:

> **Ordering Example:** LEV-3072CT-B2 ( B gable set with 1/2 height modesty)

For 3/4 height modesty add **3** to the Sku:

> **Ordering Example:** LEV-3072CT-C3 ( C gable set with 3/4 height modesty)

All modesty panels on a component are raised equally. Contact Customer Service if not all modesties are to be raised.

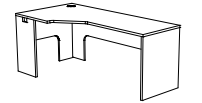

1/2 HEIGHT MODESTY

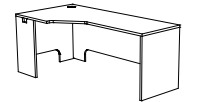

3/4 HEIGHT MODESTY

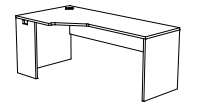

Call Customer Service

**Optional Boot Shelves:**

- ♥ All tall & mid-height wardrobe storage & storage cabinets can have an optional boot shelf.

Upcharges apply when ordering bootshelf: add **-BS** to product SKU.

> **Ordering Example:** LEV-5536C-20-SR-BS

| Bootshelf Upcharges |              |
|---------------------|--------------|
| 12"w to 23"w        | <b>\$119</b> |
| 24"w to 35"w        | <b>\$134</b> |
| 36"w or >           | <b>\$174</b> |

**Doors:**

- ♥ All cabinets, hutches and wardrobes now include **soft close hinge** doors.
- ♥ Our **NEW** writable / wipeable White Board (WB) laminate is available for door applications.

## Handles

- ♥ LEVELS Series default handle is black/aluminium Bar handles except for Grey Dusk finish which has Scoop - aluminium. Bar handle finish varies according to laminate finish - See Finish Chart [LEV-3](#)
- ♥ Any standard handle style available at no extra charge. Please specify choice if other than Bar.
- ♥ For handle choices see page [ACC 100-3](#).
- ♥ As handle choices are component specific, please clearly indicate your handle choices for each component on your PO. It is possible for different components to have different handle choices on the same PO.
- ♥ All drawers and doors have handles except for hutch doors. Hutch door handles may be added for an up-charge of **\$38** per handle

## Glazed Doors & Panels:

- ♥ All glazed doors and panels consist of an aluminum frame with a 5mm plexiglass panel.
- ♥ The price for aluminum frame glazed doors is an upcharge and must be added to the base price of the unit it goes on. Add **-AGD** and finish choice to base SKU.  
**Example:** LEV-2036C-**AGD-BR**
- ♥ AGD doors are not locking by default, add **-L** to the SKU and upcharge of **\$76**
- ♥ Doors include silver finish, bar handles (except on hutches and overheads which do not need handles).
- ♥ Frames have a natural, brushed aluminum finish.
- ♥ HML AGD doors differ from HDL and will not match if paired together.

|  |            |
|--|------------|
| Plexiglass panels are available in 3 finishes: |            |
| > Clear  | <b>-CL</b> |
| > Frosted                                      | <b>-FR</b> |
| > Bronze                                       | <b>-BR</b> |

Please indicate on your PO which plexi-glass style you would like.

## Locks:

- ♥ All tall cabinet and storage cabinet laminate doors and drawers lock, **except where noted in price book.**
- ♥ Two lock finishes are available (Silver - SL & Black BL) - see default lock finishes in the finishes chart [LEV-3](#). For substitutions, contact Customer Service
- ♥ To add an optional lock to a component or Aluminum Glazed Doors (AGD), add **-L** to the SKU and upcharge of **\$76**
- ♥ Hutch and overhead storage doors do not lock, unless requested. There is a **\$76** upcharge.
- ♥ Core removable locks are standard on all drawer pedestals, lateral files and storage cabinets.
  - > For keyed-alike locks, indicate on your order, which standard units you would like keyed-alike.
  - > Order the appropriate quantity of like numbered cores required at **\$11** each.
- ♥ **Ordering Example:** If you require 3 units to be keyed-alike, **order 100-COREPACK-3 (\$11 X 3 = \$33).**

## Accessories:

- ♥ See 100 Series ([ACC](#)) for a complete list of keyboard trays, pencil drawers, grommets, task lighting, CPU holders, etc
- ♥ Monitor arms are available in Black (BL) and Silver (SL) finish and can be both grommet mounted or clamp mounted.
- ♥ The 100 Series now has expanded options for power and data management. See the new power grommet options Accessories page [100-6](#).

## Custom Sizes:

- ♥ Custom available.....call Customer Service. Please specify quote number when ordering.
- ♥ Custom widths & depths available... For simple changes, use the price of the next model size up.
  - > **Ordering Example:** for the price of a **LEV-2766DS**: Take the price of **the next larger size...LEV-3066DS - \$837**
- ♥ **NOTE:** If doors, drawers or height are involved, or if there is no next size up, please contact Customer Service for a quote.
- ♥ Custom high-pressure laminate available, contact Customer Service for more information [cs@heartwood.ca](mailto:cs@heartwood.ca).

## Shipping:

- ♥ Some items are shipped fully assembled, some are shipped in RTA cartoning.
- ♥ Look for RTA symbol (**RTA**) at each model number.
- ♥ Weights and cubes shown are approximates and based on LEVELS Series.

## High Pressure Laminate:

- ♥ High-pressure finishes are approximations and not exact matches to Heartwood Manufacturing finishes. For more detailed finish information, please see the manufacturer's swatch (corresponding codes provided on HPL swatch card).
- ♥ See [heartwood.ca](http://heartwood.ca) for all available laminate and high pressure laminate finish.
- ♥ For custom high-pressure pressure matches or alternate choices, contact Customer Service for a quote [cs@heartwood.ca](mailto:cs@heartwood.ca)

**Sizing Comparison:**

Hutch Sizing Options

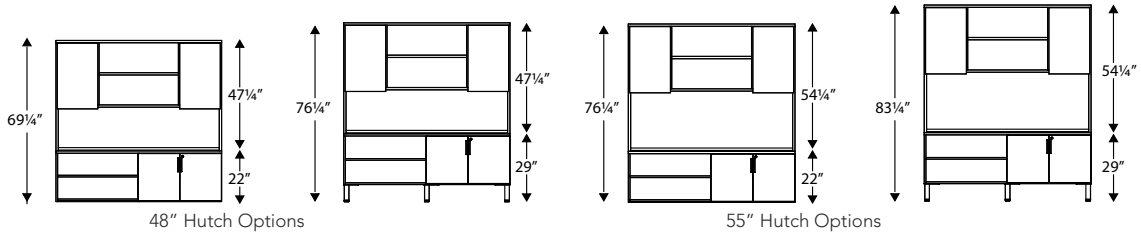
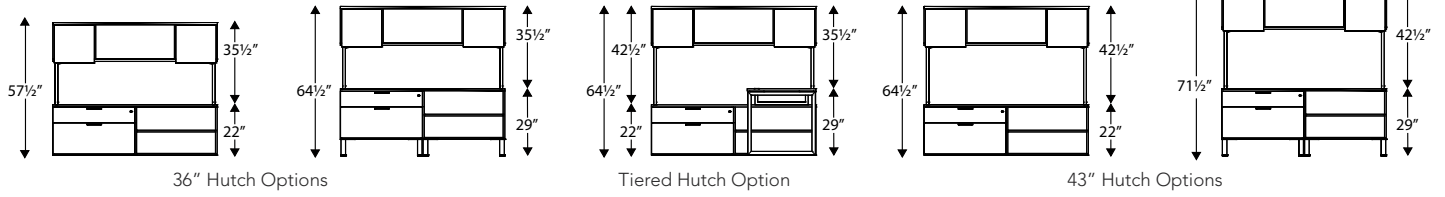

Tall Storage Sizing Options

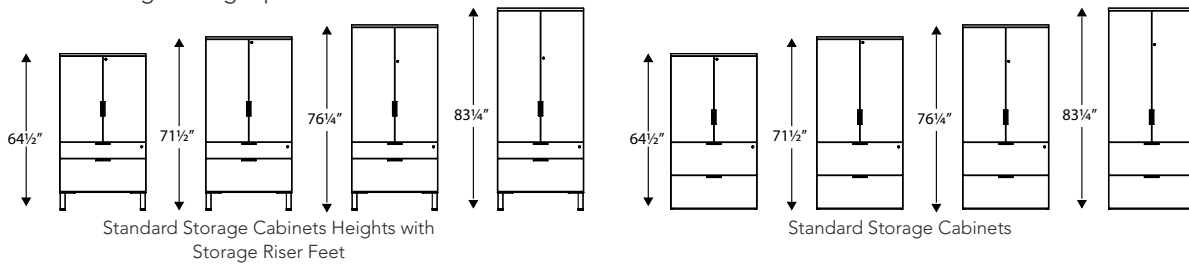

Credenza Storage Sizing

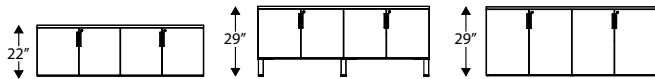

Mid-Height Storage Sizing

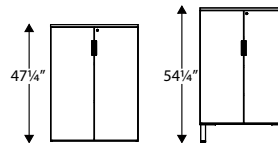

**LEVELS SERIES**  
**RECTANGULAR BULLET RETURNS**

| MODEL | LIST | WEIGHT | CUBE            | W  | D  | H  |
|-------|------|--------|-----------------|----|----|----|
|       |      | LBS    | FT <sup>3</sup> | IN | IN | IN |

**RECTANGULAR BULLET RETURN**

24" DEEP RECTANGULAR BULLET TOP DESK W/ LOOP LEG

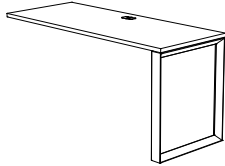

LEV-2460RET-LOOP

|                  |       |      |      |       |       |    |
|------------------|-------|------|------|-------|-------|----|
| LEV-2430RET-LOOP | \$406 | 34.8 | 2.07 | 29.5  | 23.75 | 29 |
| LEV-2436RET-LOOP | \$420 | 38.5 | 2.21 | 35.5  | 23.75 | 29 |
| LEV-2442RET-LOOP | \$441 | 42.2 | 2.36 | 41.5  | 23.75 | 29 |
| LEV-2448RET-LOOP | \$463 | 45.8 | 2.5  | 47.25 | 23.75 | 29 |
| LEV-2454RET-LOOP | \$484 | 49.2 | 2.64 | 53    | 23.75 | 29 |
| LEV-2460RET-LOOP | \$614 | 53.2 | 2.79 | 59.25 | 23.75 | 29 |
| LEV-2466RET-LOOP | \$635 | 56.7 | 2.93 | 65    | 23.75 | 29 |
| LEV-2472RET-LOOP | \$660 | 60.5 | 3.08 | 71    | 23.75 | 29 |

30" DEEP RECTANGULAR BULLET TOP DESK W/ LOOP LEG

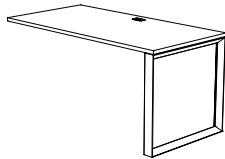

LEV-3060RET-LOOP

|                  |       |      |      |       |      |    |
|------------------|-------|------|------|-------|------|----|
| LEV-3048RET-LOOP | \$512 | 52.8 | 3.04 | 47.25 | 29.5 | 29 |
| LEV-3054RET-LOOP | \$593 | 95   | 3.21 | 53    | 29.5 | 29 |
| LEV-3060RET-LOOP | \$654 | 62.1 | 3.4  | 59.25 | 29.5 | 29 |
| LEV-3066RET-LOOP | \$664 | 66.5 | 3.57 | 65    | 29.5 | 29 |
| LEV-3072RET-LOOP | \$696 | 71.1 | 3.74 | 71    | 29.5 | 29 |

- STIFFENER INCLUDED - REQUIRES STIFFENER BAR IF UNSUPPORTED 48" OR GREATER

24" DEEP RECTANGULAR BULLET TOP DESK W/ SQUARE OFFSET LEGS

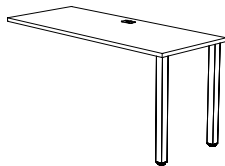

LEV-2460RET-SQ2

|                 |       |      |      |       |       |    |
|-----------------|-------|------|------|-------|-------|----|
| LEV-2430RET-SQ2 | \$393 | 34.8 | 2.07 | 29.5  | 23.75 | 29 |
| LEV-2436RET-SQ2 | \$408 | 38.5 | 2.21 | 35.5  | 23.75 | 29 |
| LEV-2442RET-SQ2 | \$429 | 42.2 | 2.36 | 41.5  | 23.75 | 29 |
| LEV-2448RET-SQ2 | \$449 | 45.8 | 2.5  | 47.25 | 23.75 | 29 |
| LEV-2454RET-SQ2 | \$471 | 49.2 | 2.64 | 53    | 23.75 | 29 |
| LEV-2460RET-SQ2 | \$602 | 53.2 | 2.79 | 59.25 | 23.75 | 29 |
| LEV-2466RET-SQ2 | \$623 | 56.7 | 2.93 | 65    | 23.75 | 29 |
| LEV-2472RET-SQ2 | \$648 | 60.5 | 3.08 | 71    | 23.75 | 29 |

30" DEEP RECTANGULAR BULLET TOP DESK W/ LOOP LEG

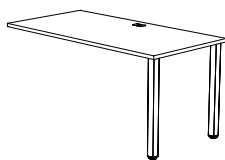

LEV-3060RET-SQ2

|                 |       |      |      |       |      |    |
|-----------------|-------|------|------|-------|------|----|
| LEV-3048RET-SQ2 | \$498 | 52.8 | 3.04 | 47.25 | 29.5 | 29 |
| LEV-3054RET-SQ2 | \$579 | 57.2 | 3.21 | 53    | 29.5 | 29 |
| LEV-3060RET-SQ2 | \$642 | 62.1 | 3.4  | 59.25 | 29.5 | 29 |
| LEV-3066RET-SQ2 | \$651 | 66.5 | 3.57 | 65    | 29.5 | 29 |
| LEV-3072RET-SQ2 | \$686 | 71.1 | 3.74 | 71    | 29.5 | 29 |

- STIFFENER INCLUDED - REQUIRES STIFFENER BAR IF UNSUPPORTED 48" OR GREATER
- CONNECTING HARDWARE (FLAT BRACKETS) INCLUDED
- RETURNS HAVE ONE CENTERED GROMMET. INDICATE ON PO IF GROMMET IS NOT REQUIRED, NO EXTRA CHARGE.

**RTA**

| MODEL | LIST | WEIGHT | CUBE            | W  | D  | H  |
|-------|------|--------|-----------------|----|----|----|
|       |      | LBS    | FT <sup>3</sup> | IN | IN | IN |

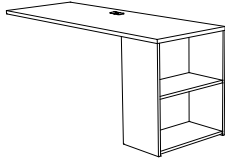

LEV-2460RET-COX

24" DEEP RECTANGULAR BULLET TOP DESK W/ OPEN CABINET

|                 |                |      |      |       |       |    |
|-----------------|----------------|------|------|-------|-------|----|
| LEV-2442RET-COX | <b>\$925</b>   | 61.4 | 2.41 | 41.5  | 23.75 | 29 |
| LEV-2448RET-COX | <b>\$978</b>   | 64.9 | 2.73 | 47.25 | 23.75 | 29 |
| LEV-2454RET-COX | <b>\$981</b>   | 68.4 | 3.03 | 53    | 23.75 | 29 |
| LEV-2460RET-COX | <b>\$1,072</b> | 72.4 | 3.38 | 59.25 | 23.75 | 29 |
| LEV-2466RET-COX | <b>\$1,074</b> | 75.9 | 3.69 | 65    | 23.75 | 29 |
| LEV-2472RET-COX | <b>\$1,098</b> | 79.6 | 4.02 | 71    | 23.75 | 29 |

- OPEN CABINET IS 13" DEEP, ADJUSTABLE SHELF
- STIFFENER INCLUDED - REQUIRES STIFFENER BAR IF UNSUPPORTED 60" OR GREATER

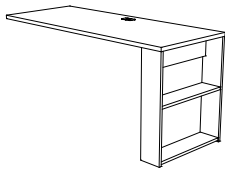

LEV-2460RET-SOX

24" DEEP RECTANGULAR BULLET TOP DESK W/ SHELF OPEN

|                 |              |      |     |       |       |    |
|-----------------|--------------|------|-----|-------|-------|----|
| LEV-2442RET-SOX | <b>\$660</b> | 37.9 | 2.3 | 41.5  | 23.75 | 29 |
| LEV-2448RET-SOX | <b>\$678</b> | 41.5 | 2.6 | 47.25 | 23.75 | 29 |
| LEV-2454RET-SOX | <b>\$790</b> | 45.1 | 2.9 | 53    | 23.75 | 29 |
| LEV-2460RET-SOX | <b>\$822</b> | 48.7 | 3.2 | 59.25 | 23.75 | 29 |
| LEV-2466RET-SOX | <b>\$933</b> | 52.2 | 3.6 | 65    | 23.75 | 29 |
| LEV-2472RET-SOX | <b>\$970</b> | 55.8 | 3.9 | 71    | 23.75 | 29 |

- GABLE DEPTH 6", NO BACK
- ONE CENTERED GROMMET. INDICATE ON PO IF GROMMET IS NOT REQUIRED, NO EXTRA CHARGE. STIFFENER INCLUDED - REQUIRES STIFFENER BAR IF UNSUPPORTED 60" OR GREATER

**TIERED RECTANGULAR BULLET RETURN**

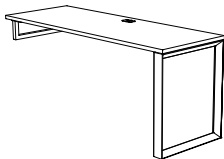

LEV-TR2466-LOOP

24" DEEP TIERED RECTANGULAR BULLET TOP W/ A LOOP LEG

|                 |              |      |      |       |       |    |
|-----------------|--------------|------|------|-------|-------|----|
| LEV-TR2460-LOOP | <b>\$783</b> | 57.2 | 5.2  | 59.25 | 23.75 | 29 |
| LEV-TR2466-LOOP | <b>\$803</b> | 60.7 | 5.51 | 65    | 23.75 | 29 |
| LEV-TR2472-LOOP | <b>\$828</b> | 64.4 | 5.84 | 71    | 23.75 | 29 |
| LEV-TR2484-LOOP | <b>\$841</b> | 71.7 | 6.48 | 82.75 | 23.75 | 29 |
| LEV-TR2496-LOOP | <b>\$961</b> | 79   | 7.11 | 94.5  | 23.75 | 29 |

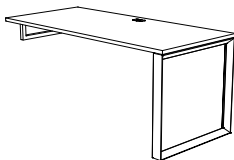

LEV-TR3066-LOOP

30" DEEP TIERED RECTANGULAR BULLET TOP W/ A LOOP LEG

|                 |              |      |      |       |      |    |
|-----------------|--------------|------|------|-------|------|----|
| LEV-TR3060-LOOP | <b>\$840</b> | 66   | 5.93 | 59.25 | 29.5 | 29 |
| LEV-TR3066-LOOP | <b>\$859</b> | 70.5 | 6.31 | 65    | 29.5 | 29 |
| LEV-TR3072-LOOP | <b>\$878</b> | 75.1 | 6.7  | 71    | 29.5 | 29 |
| LEV-TR3084-LOOP | <b>\$919</b> | 84.1 | 7.48 | 82.75 | 29.5 | 29 |
| LEV-TR3096-LOOP | <b>\$974</b> | 93.1 | 8.26 | 94.5  | 29.5 | 29 |

- STIFFENER INCLUDED - REQUIRES STIFFENER BAR IF UNSUPPORTED 60" OR GREATER

# LEVELS SERIES

## RECTANGULAR BULLET RETURNS

| MODEL | LIST | WEIGHT | CUBE            | W  | D  | H  |
|-------|------|--------|-----------------|----|----|----|
|       |      | LBS    | FT <sup>3</sup> | IN | IN | IN |

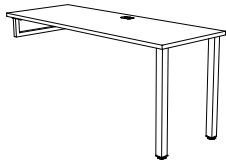

LEV-TR2466-SQ2

### 24" DEEP TIERED RECTANGULAR BULLET TOP W/ SQUARE OFFSET LEGS

|                |       |      |      |       |       |    |
|----------------|-------|------|------|-------|-------|----|
| LEV-TR2460-SQ2 | \$771 | 57.2 | 5.2  | 59.25 | 23.75 | 29 |
| LEV-TR2466-SQ2 | \$792 | 60.7 | 5.51 | 65    | 23.75 | 29 |
| LEV-TR2472-SQ2 | \$817 | 64.4 | 5.84 | 71    | 23.75 | 29 |
| LEV-TR2484-SQ2 | \$906 | 71.7 | 6.48 | 82.75 | 23.75 | 29 |
| LEV-TR2496-SQ2 | \$960 | 79   | 7.11 | 94.5  | 29.5  | 29 |

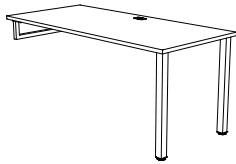

LEV-TR3066-SQ2

### 30" DEEP TIERED RECTANGULAR BULLET TOP W/ SQUARE OFFSET LEGS

|                |         |      |      |       |      |    |
|----------------|---------|------|------|-------|------|----|
| LEV-TR3060-SQ2 | \$826   | 66   | 5.93 | 59.25 | 29.5 | 29 |
| LEV-TR3066-SQ2 | \$846   | 70.5 | 6.31 | 65    | 29.5 | 29 |
| LEV-TR3072-SQ2 | \$866   | 75.1 | 6.7  | 71    | 29.5 | 29 |
| LEV-TR3084-SQ2 | \$982   | 84.1 | 7.48 | 82.75 | 29.5 | 29 |
| LEV-TR3096-SQ2 | \$1,134 | 93.1 | 8.26 | 94.5  | 29.5 | 29 |

- STIFFENER INCLUDED - REQUIRES STIFFENER BAR IF UNSUPPORTED 60" OR GREATER

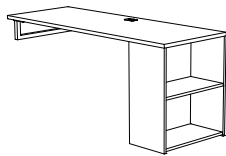

LEV-TR2466-COX

### 24" DEEP TIERED RECTANGULAR BULLET TOP W/ OPEN CABINET

|                |         |      |      |       |       |    |
|----------------|---------|------|------|-------|-------|----|
| LEV-TR2460-COX | \$1,098 | 72.4 | 3.38 | 59.25 | 23.75 | 29 |
| LEV-TR2466-COX | \$1,162 | 75.9 | 3.69 | 65    | 23.75 | 29 |
| LEV-TR2472-COX | \$1,182 | 79.6 | 4.02 | 71    | 23.75 | 29 |
| LEV-TR2484-COX | \$1,380 | 86.9 | 4.66 | 82.75 | 23.75 | 29 |
| LEV-TR2496-COX | \$1,391 | 94.2 | 5.29 | 94.5  | 23.75 | 29 |

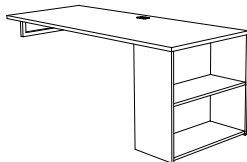

LEV-TR3072-COX

### 30" DEEP TIERED RECTANGULAR BULLET TOP W/ OPEN CABINET

|                |         |       |      |       |      |    |
|----------------|---------|-------|------|-------|------|----|
| LEV-TR3060-COX | \$1,142 | 87.1  | 4.11 | 59.25 | 29.5 | 29 |
| LEV-TR3066-COX | \$1,242 | 91.5  | 4.49 | 65    | 29.5 | 29 |
| LEV-TR3072-COX | \$1,270 | 96.1  | 4.89 | 71    | 29.5 | 29 |
| LEV-TR3084-COX | \$1,437 | 105.2 | 5.66 | 82.75 | 29.5 | 29 |
| LEV-TR3096-COX | \$1,560 | 114.2 | 6.44 | 94.5  | 29.5 | 29 |

- OPEN CABINET IS 13" DEEP, ADJUSTABLE SHELF
- STIFFENER INCLUDED - REQUIRES STIFFENER BAR IF UNSUPPORTED 60" OR GREATER
- TIERED RETURNS HAVE ONE CENTERED GROMMET. INDICATE ON PO IF GROMMET IS NOT REQUIRED, NO EXTRA CHARGE.

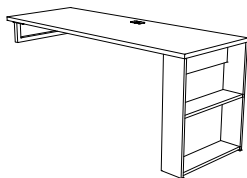

LEV-TR2466-SOX

### 24" DEEP TIERED RECTANGULAR BULLET TOP W/ SHELF OPEN

|                |         |      |     |       |       |    |
|----------------|---------|------|-----|-------|-------|----|
| LEV-TR2460-SOX | \$901   | 62.8 | 2.9 | 59.25 | 23.75 | 29 |
| LEV-TR2466-SOX | \$1,012 | 66.3 | 3.1 | 65    | 23.75 | 29 |
| LEV-TR2472-SOX | \$1,049 | 69.9 | 3.4 | 71    | 23.75 | 29 |
| LEV-TR2484-SOX | \$1,144 | 77.1 | 3.9 | 82.75 | 23.75 | 29 |
| LEV-TR2496-SOX | \$1,283 | 84.3 | 4.5 | 94.5  | 23.75 | 29 |



| MODEL | LIST | WEIGHT | CUBE            | W  | D  | H  |
|-------|------|--------|-----------------|----|----|----|
|       |      | LBS    | FT <sup>3</sup> | IN | IN | IN |



LEV-TR3060-SOX

30" DEEP TIERED RECTANGULAR BULLET TOP W/ SHELF OPEN

|                |         |       |     |       |      |    |
|----------------|---------|-------|-----|-------|------|----|
| LEV-TR3060-SOX | \$981   | 73.6  | 3.5 | 59.25 | 29.5 | 29 |
| LEV-TR3066-SOX | \$1,092 | 78.1  | 3.8 | 65    | 29.5 | 29 |
| LEV-TR3072-SOX | \$1,129 | 82.6  | 4.1 | 71    | 29.5 | 29 |
| LEV-TR3084-SOX | \$1,223 | 91.5  | 4.8 | 82.75 | 29.5 | 29 |
| LEV-TR3096-SOX | \$1,362 | 100.5 | 5.4 | 94.5  | 29.5 | 29 |

- GABLE DEPTH 6", NO BACK
- STIFFENER INCLUDED - REQUIRES STIFFENER BAR IF UNSUPPORTED 60" OR GREATER
- ONE CENTERED GROMMET. INDICATE ON PO IF GROMMET IS NOT REQUIRED, NO EXTRA CHARGE.

**BRIDGES**

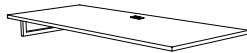

LEV-TR3072BR

24" DEEP TIERED BRIDGE

|              |       |    |     |       |       |    |
|--------------|-------|----|-----|-------|-------|----|
| LEV-TR2460BR | \$615 | 42 | 3   | 59.25 | 23.75 | 29 |
| LEV-TR2466BR | \$636 | 48 | 3.2 | 65    | 23.75 | 29 |
| LEV-TR2472BR | \$660 | 51 | 3.4 | 71    | 23.75 | 29 |

30" DEEP TIERED BRIDGE

|              |       |    |     |       |      |    |
|--------------|-------|----|-----|-------|------|----|
| LEV-TR3060BR | \$672 | 52 | 3.5 | 59.25 | 29.5 | 29 |
| LEV-TR3066BR | \$691 | 57 | 3.7 | 65    | 29.5 | 29 |
| LEV-TR3072BR | \$711 | 62 | 4   | 71    | 29.5 | 29 |

- REQUIRES STIFFENER BAR IF UNSUPPORTED 60" OR GREATER - STIFFENER INCLUDED
- CONNECTING HARDWARE (FLAT BRACKETS) INCLUDED
- ONE CENTERED GROMMET. INDICATE ON PO IF GROMMET IS NOT REQUIRED, NO EXTRA CHARGE.

**TABLES**

**TABLE W/ LOOP LEGS**

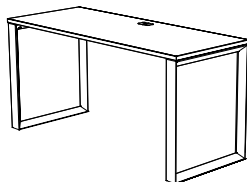

LEV-2460TBL-LOOP

24" DEEP W/ LOOP LEG

|                  |       |      |      |       |       |    |
|------------------|-------|------|------|-------|-------|----|
| LEV-2436TBL-LOOP | \$555 | 55   | 5.17 | 35.5  | 23.75 | 29 |
| LEV-2442TBL-LOOP | \$593 | 58.7 | 5.5  | 41.5  | 23.75 | 29 |
| LEV-2448TBL-LOOP | \$623 | 62.3 | 5.81 | 47.25 | 23.75 | 29 |
| LEV-2454TBL-LOOP | \$711 | 65.8 | 6.1  | 53    | 23.75 | 29 |
| LEV-2460TBL-LOOP | \$783 | 69.7 | 6.46 | 59.25 | 23.75 | 29 |
| LEV-2466TBL-LOOP | \$813 | 73.3 | 6.78 | 65    | 23.75 | 29 |
| LEV-2472TBL-LOOP | \$837 | 77   | 7.1  | 71    | 23.75 | 29 |

RTA

# LEVELS SERIES TABLES

| MODEL | LIST | WEIGHT | CUBE            | W  | D  | H  |
|-------|------|--------|-----------------|----|----|----|
|       |      | LBS    | FT <sup>3</sup> | IN | IN | IN |

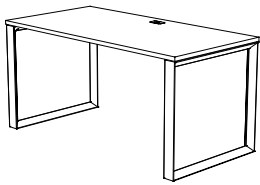

LEV-3060TBL-LOOP

### 30" DEEP W/ LOOP LEG

|                  |       |      |      |       |      |    |
|------------------|-------|------|------|-------|------|----|
| LEV-3048TBL-LOOP | \$691 | 62.3 | 5.81 | 47.25 | 29.5 | 29 |
| LEV-3054TBL-LOOP | \$823 | 65.8 | 6.12 | 53    | 29.5 | 29 |
| LEV-3060TBL-LOOP | \$868 | 69.7 | 6.46 | 59.25 | 29.5 | 29 |
| LEV-3066TBL-LOOP | \$898 | 73.3 | 6.78 | 65    | 29.5 | 29 |
| LEV-3072TBL-LOOP | \$915 | 77   | 7.1  | 71    | 29.5 | 29 |

- STIFFENER INCLUDED - REQUIRES STIFFENER BAR IF UNSUPPORTED 48" OR GREATER

### TABLE W/ SQUARE OFFSET LEGS

#### 24" DEEP W/ SQUARE OFFSET LEGS

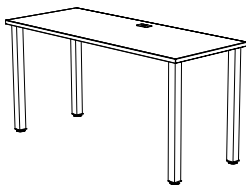

LEV-2460TBL-SQ2

|                 |       |      |      |       |       |    |
|-----------------|-------|------|------|-------|-------|----|
| LEV-2436TBL-SQ2 | \$527 | 55   | 5.17 | 35.5  | 23.75 | 29 |
| LEV-2442TBL-SQ2 | \$563 | 58.7 | 5.5  | 41.5  | 23.75 | 29 |
| LEV-2448TBL-SQ2 | \$594 | 62.3 | 5.81 | 47.25 | 23.75 | 29 |
| LEV-2454TBL-SQ2 | \$683 | 65.8 | 6.12 | 53    | 23.75 | 29 |
| LEV-2460TBL-SQ2 | \$753 | 69.7 | 6.46 | 59.25 | 23.75 | 29 |
| LEV-2466TBL-SQ2 | \$783 | 73.3 | 6.78 | 65    | 23.75 | 29 |
| LEV-2472TBL-SQ2 | \$806 | 77   | 7.1  | 71    | 23.75 | 29 |

#### 30" DEEP W/ SQUARE OFFSET LEGS

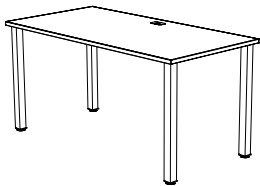

LEV-3060TBL-SQ2

|                 |       |      |      |       |      |    |
|-----------------|-------|------|------|-------|------|----|
| LEV-3048TBL-SQ2 | \$663 | 62.3 | 5.81 | 47.25 | 29.5 | 29 |
| LEV-3054TBL-SQ2 | \$793 | 65.8 | 6.12 | 53    | 29.5 | 29 |
| LEV-3060TBL-SQ2 | \$840 | 69.7 | 6.46 | 59.25 | 29.5 | 29 |
| LEV-3066TBL-SQ2 | \$868 | 73.3 | 6.78 | 65    | 29.5 | 29 |
| LEV-3072TBL-SQ2 | \$885 | 77   | 7.1  | 71    | 29.5 | 29 |

- STIFFENER INCLUDED - REQUIRES STIFFENER BAR IF UNSUPPORTED 48" OR GREATER
- TABLES INCLUDE ONE CENTERED GROMMET. INDICATE ON PO IF GROMMET IS NOT REQUIRED, NO EXTRA CHARGE.

### TABLE W/ OPEN CABINET

#### 30" DEEP W/ LOOP LEG & OPEN CABINET

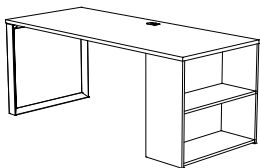

LEV-3072TBL-LOOP-COX

|                      |         |       |     |       |      |    |
|----------------------|---------|-------|-----|-------|------|----|
| LEV-3060TBL-LOOP-COX | \$886   | 102.9 | 4.1 | 59.25 | 29.5 | 29 |
| LEV-3066TBL-LOOP-COX | \$1,323 | 107.4 | 4.5 | 65    | 29.5 | 29 |
| LEV-3072TBL-LOOP-COX | \$1,342 | 111.9 | 4.9 | 71    | 29.5 | 29 |

#### 30" DEEP W/ SQUARE OFFSET LEGS & OPEN CABINET

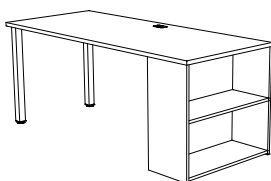

LEV-3072TBL-SQ2-COX

|                     |         |      |     |       |      |    |
|---------------------|---------|------|-----|-------|------|----|
| LEV-3060TBL-SQ2-COX | \$873   | 93.1 | 4.1 | 59.25 | 29.5 | 29 |
| LEV-3066TBL-SQ2-COX | \$1,310 | 97.5 | 4.5 | 65    | 29.5 | 29 |
| LEV-3072TBL-SQ2-COX | \$1,331 | 102  | 4.9 | 71    | 29.5 | 29 |

- STIFFENER INCLUDED - REQUIRES STIFFENER BAR IF UNSUPPORTED 60" OR GREATER
- LOOP LEG & OPEN SHELVING ARE NON-HANDED
- OPEN CABINET IS 13" DEEP, ADJUSTABLE SHELF
- TABLES INCLUDE ONE CENTERED GROMMET. INDICATE ON PO IF GROMMET IS NOT REQUIRED, NO EXTRA CHARGE.

| MODEL | LIST | WEIGHT | CUBE            | W  | D  | H  |
|-------|------|--------|-----------------|----|----|----|
|       |      | LBS    | FT <sup>3</sup> | IN | IN | IN |

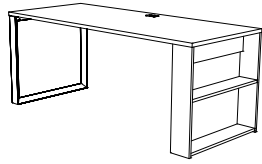

LEV-3072TBL-LOOP-SOX

30" DEEP TABLE, W/ LOOP LEG & SHELF OPEN

|                      |                |      |     |       |      |    |
|----------------------|----------------|------|-----|-------|------|----|
| LEV-3060TBL-LOOP-SOX | <b>\$1,028</b> | 76.8 | 4.1 | 59.25 | 29.5 | 29 |
| LEV-3066TBL-LOOP-SOX | <b>\$1,140</b> | 81.3 | 4.5 | 65    | 29.5 | 29 |
| LEV-3072TBL-LOOP-SOX | <b>\$1,177</b> | 85.8 | 4.9 | 71    | 29.5 | 29 |

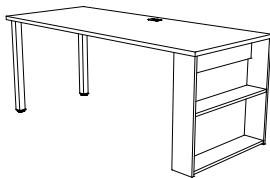

LEV-3072TBL-SQ2-SOX

30" DEEP TABLE, W/ SQUARE OFFSET LEGS & SHELF OPEN

|                     |                |      |     |       |      |    |
|---------------------|----------------|------|-----|-------|------|----|
| LEV-3060TBL-SQ2-SOX | <b>\$1,012</b> | 70.8 | 4.1 | 59.25 | 29.5 | 29 |
| LEV-3066TBL-SQ2-SOX | <b>\$1,124</b> | 75.3 | 4.5 | 65    | 29.5 | 29 |
| LEV-3072TBL-SQ2-SOX | <b>\$1,161</b> | 79.8 | 4.9 | 71    | 29.5 | 29 |

- GABLE DEPTH 6", NO BACK
- STIFFENER INCLUDED - REQUIRES STIFFENER BAR IF UNSUPPORTED 60" OR GREATER
- METAL LEGS & OPEN SHELVING ARE NON-HANDED
- INCLUDES ONE CENTERED GROMMET. INDICATE ON PO IF GROMMET IS NOT REQUIRED, NO EXTRA CHARGE.

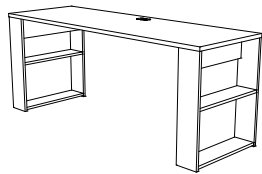

LEV-2472TBL-SOX2

24" DEEP TABLE W/ 2 X SHELF OPEN

|                  |                |      |     |       |       |    |
|------------------|----------------|------|-----|-------|-------|----|
| LEV-2442TBL-SOX2 | <b>\$793</b>   | 50.9 | 1.9 | 41.5  | 23.75 | 29 |
| LEV-2448TBL-SOX2 | <b>\$811</b>   | 54.5 | 2.2 | 47.25 | 23.75 | 29 |
| LEV-2454TBL-SOX2 | <b>\$922</b>   | 58.1 | 2.4 | 53    | 23.75 | 29 |
| LEV-2460TBL-SOX2 | <b>\$954</b>   | 61.7 | 2.7 | 59.25 | 23.75 | 29 |
| LEV-2466TBL-SOX2 | <b>\$1,065</b> | 65.3 | 2.9 | 65    | 23.75 | 29 |
| LEV-2472TBL-SOX2 | <b>\$1,102</b> | 68.9 | 3.2 | 71    | 23.75 | 29 |



LEV-3072TBL-SOX2

30" DEEP TABLE W/ 2 X SHELF OPEN

|                  |                |      |     |       |      |    |
|------------------|----------------|------|-----|-------|------|----|
| LEV-3048TBL-SOX2 | <b>\$859</b>   | 65.4 | 2.6 | 47.25 | 29.5 | 29 |
| LEV-3054TBL-SOX2 | <b>\$970</b>   | 69.9 | 3   | 53    | 29.5 | 29 |
| LEV-3060TBL-SOX2 | <b>\$1,002</b> | 74.4 | 3.3 | 59.25 | 29.5 | 29 |
| LEV-3066TBL-SOX2 | <b>\$1,113</b> | 78.9 | 3.6 | 65    | 29.5 | 29 |
| LEV-3072TBL-SOX2 | <b>\$1,150</b> | 83.4 | 3.9 | 71    | 29.5 | 29 |

- GABLE DEPTH 6", NO BACK
- INCLUDES ONE CENTERED GROMMET. INDICATE ON PO IF GROMMET IS NOT REQUIRED, NO EXTRA CHARGE.
- STIFFENER INCLUDED - REQUIRES STIFFENER BAR IF UNSUPPORTED 60" OR GREATER

RTA

**LEVELS SERIES**  
HEIGHT ADJUSTABLE DESKS

| MODEL | LIST | WEIGHT | CUBE            | W  | D  | H  |
|-------|------|--------|-----------------|----|----|----|
|       |      | LBS    | FT <sup>3</sup> | IN | IN | IN |

**ATHENA HEIGHT ADJUSTABLE DESK**

24" DEEP HEIGHT ADJUSTABLE DESK



LEV-2460-ATH-2L

|                 |         |       |     |       |       |           |
|-----------------|---------|-------|-----|-------|-------|-----------|
| LEV-2448-ATH-2L | \$1,442 | 103.9 | 4.8 | 47.25 | 23.75 | 28.5-46.5 |
| LEV-2460-ATH-2L | \$1,565 | 109.5 | 4.2 | 59.25 | 23.75 | 28.5-46.5 |
| LEV-2466-ATH-2L | \$1,594 | 113.1 | 4.3 | 65    | 23.75 | 28.5-46.5 |
| LEV-2472-ATH-2L | \$1,618 | 116.7 | 4.5 | 71    | 23.75 | 28.5-46.5 |
| LEV-2484-ATH-2L | \$1,689 | 123.9 | 4.8 | 82.75 | 23.75 | 28.5-46.5 |

30" DEEP HEIGHT ADJUSTABLE DESK

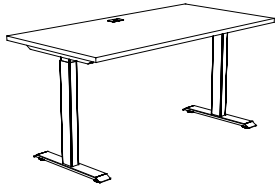

LEV-3060-ATH-2L

|                 |         |       |     |       |      |           |
|-----------------|---------|-------|-----|-------|------|-----------|
| LEV-3060-ATH-2L | \$1,610 | 118.5 | 4.5 | 59.25 | 29.5 | 28.5-46.5 |
| LEV-3066-ATH-2L | \$1,640 | 123   | 4.7 | 65    | 29.5 | 28.5-46.5 |
| LEV-3072-ATH-2L | \$1,663 | 127.5 | 4.9 | 71    | 29.5 | 28.5-46.5 |
| LEV-3084-ATH-2L | \$1,724 | 136.4 | 5.2 | 82.75 | 29.5 | 28.5-46.5 |

- HEIGHT RANGE INCLUDING TOP 28.5" - 46.5"
- MAX WEIGHT CAPACITY 220 LBS
- CENTER GROMMET

AVAILABLE BASE FINISHES:

SILVER (SL) & BLACK (BL)

AVAILABLE TOP FINISHES

ALL HEARTWOOD STANDARD LAMINATE TOP FINISHES

**CALYPSO HEIGHT ADJUSTABLE DESK**

24" DEEP HEIGHT ADJUSTABLE DESK

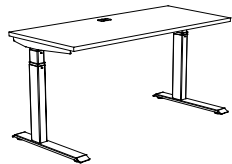

LEV-2460-CAL-2L

|                 |         |       |     |       |       |         |
|-----------------|---------|-------|-----|-------|-------|---------|
| LEV-2448-CAL-2L | \$1,784 | 121.5 | 4.7 | 47.25 | 23.75 | 25.5-51 |
| LEV-2460-CAL-2L | \$1,918 | 123.9 | 4.9 | 59.25 | 23.75 | 25.5-51 |
| LEV-2466-CAL-2L | \$1,946 | 127.5 | 5.1 | 65    | 23.75 | 25.5-51 |
| LEV-2472-CAL-2L | \$1,971 | 131   | 5.2 | 71    | 23.75 | 25.5-51 |
| LEV-2484-CAL-2L | \$2,041 | 138.2 | 5.5 | 82.75 | 23.75 | 25.5-51 |

30" DEEP HEIGHT ADJUSTABLE DESK



LEV-3060-CAL-2L

|                 |         |       |     |       |      |         |
|-----------------|---------|-------|-----|-------|------|---------|
| LEV-3060-CAL-2L | \$1,963 | 132.8 | 5.3 | 59.25 | 29.5 | 25.5-51 |
| LEV-3066-CAL-2L | \$2,007 | 137.3 | 5.4 | 65    | 29.5 | 25.5-51 |
| LEV-3072-CAL-2L | \$1,993 | 141.8 | 5.6 | 71    | 29.5 | 25.5-51 |
| LEV-3084-CAL-2L | \$2,051 | 150.8 | 5.9 | 82.75 | 29.5 | 25.5-51 |

- HEIGHT RANGE EXCLUDING TOP 22" - 48"
- MAX WEIGHT CAPACITY 265LBS
- CENTER GROMMET

AVAILABLE BASE FINISHES:

SILVER (SL), BLACK (BL) & WHITE (WH)

AVAILABLE TOP FINISHES

ALL HEARTWOOD STANDARD LAMINATE TOP FINISHES

SEE "HEIGHT ADJUSTABLE SERIES" FOR ADDITIONAL BASE SPECIFICATIONS

| MODEL | LIST | WEIGHT | CUBE            | W  | D  | H  |
|-------|------|--------|-----------------|----|----|----|
|       |      | LBS    | FT <sup>3</sup> | IN | IN | IN |

**BOW TOP DESK SHELL**

MODESTY PANEL RECESSED 10" AT GABLE

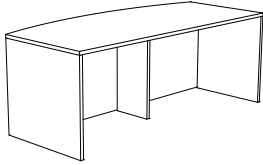

LEV-B3678DS

|             |         |       |     |       |      |    |
|-------------|---------|-------|-----|-------|------|----|
| LEV-B3678DS | \$1,275 | 153.7 | 7   | 77    | 35.5 | 29 |
| LEV-B3684DS | \$1,343 | 161.7 | 7.6 | 82.75 | 35.5 | 29 |
| LEV-B3690DS | \$1,498 | 169.7 | 8.1 | 88.75 | 35.5 | 29 |
| LEV-B3696DS | \$1,650 | 177.8 | 8.6 | 94.5  | 35.5 | 29 |

- UNSUPPORTED UNITS OVER 72" REQUIRE CENTER SUPPORT GABLE. ADD +C TO SKU & UPCHARGE OF **\$198**

|             |         |       |     |    |      |    |
|-------------|---------|-------|-----|----|------|----|
| LEV-B4272DS | \$1,235 | 164.7 | 7.5 | 71 | 41.5 | 29 |
|-------------|---------|-------|-----|----|------|----|

- UNSUPPORTED UNITS OVER 72" REQUIRE CENTER SUPPORT GABLE. ADD +C TO SKU & UPCHARGE OF **\$198**

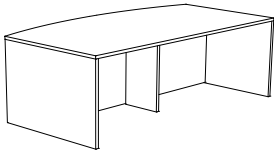

LEV-B4278DS

|             |         |       |     |       |      |    |
|-------------|---------|-------|-----|-------|------|----|
| LEV-B4278DS | \$1,389 | 173.6 | 8.1 | 77    | 41.5 | 29 |
| LEV-B4284DS | \$1,456 | 182.6 | 8.8 | 82.75 | 41.5 | 29 |
| LEV-B4290DS | \$1,613 | 191.5 | 9.4 | 88.75 | 41.5 | 29 |
| LEV-B4296DS | \$1,776 | 200.4 | 10  | 94.5  | 41.5 | 29 |

**RTA**

**DESK SHELL**

30" DESK, MODESTY PANEL RECESSED 4"

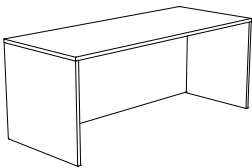

LEV-3072DS

|            |       |       |     |       |      |    |
|------------|-------|-------|-----|-------|------|----|
| LEV-3060DS | \$803 | 115.1 | 4.5 | 59.25 | 29.5 | 29 |
| LEV-3066DS | \$837 | 122.5 | 5   | 65    | 29.5 | 29 |
| LEV-3072DS | \$878 | 130   | 5.5 | 71    | 29.5 | 29 |

- UNSUPPORTED UNITS OVER 72" REQUIRE CENTER SUPPORT GABLE. ADD +C TO SKU & UPCHARGE OF **\$198**

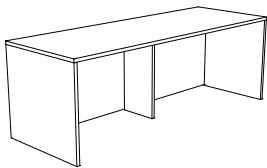

LEV-3084DS+C

|            |         |       |     |       |      |    |
|------------|---------|-------|-----|-------|------|----|
| LEV-3078DS | \$993   | 145.9 | 6   | 77    | 29.5 | 29 |
| LEV-3084DS | \$1,025 | 153.3 | 6.4 | 82.75 | 29.5 | 29 |
| LEV-3090DS | \$1,244 | 160.8 | 6.8 | 88.75 | 29.5 | 29 |
| LEV-3096DS | \$1,352 | 168.2 | 7.3 | 94.5  | 29.5 | 29 |

|            |         |     |     |    |      |    |
|------------|---------|-----|-----|----|------|----|
| LEV-3672DS | \$1,077 | 149 | 6.5 | 71 | 35.5 | 29 |
|------------|---------|-----|-----|----|------|----|

- UNSUPPORTED UNITS OVER 72" REQUIRE CENTER SUPPORT GABLE. ADD +C TO SKU & UPCHARGE OF **\$198**

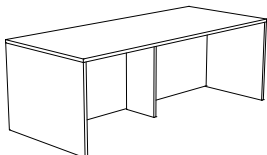

LEV-3684DS+C

|            |         |       |     |       |      |    |
|------------|---------|-------|-----|-------|------|----|
| LEV-3678DS | \$1,117 | 166   | 7   | 77    | 35.5 | 29 |
| LEV-3684DS | \$1,176 | 174.3 | 7.6 | 82.75 | 35.5 | 29 |
| LEV-3690DS | \$1,394 | 182.7 | 8.1 | 88.75 | 35.5 | 29 |
| LEV-3696DS | \$1,500 | 191   | 8.6 | 94.5  | 35.5 | 29 |

- MODESTY PANEL CAN BE TWO-TONED AT NO EXTRA CHARGE

**RTA**

| MODEL | LIST | WEIGHT | CUBE            | W  | D  | H  |
|-------|------|--------|-----------------|----|----|----|
|       |      | LBS    | FT <sup>3</sup> | IN | IN | IN |

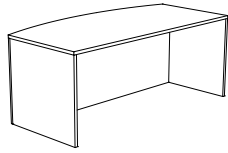

**BOW TOP DESK SHELL W/ EXTENDED PEDESTALS**

FLAT MODESTY

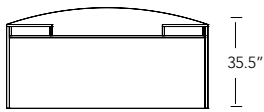

71"  
LEV-SB3672DS

|              |         |       |      |    |      |    |
|--------------|---------|-------|------|----|------|----|
| LEV-SB3672DS | \$1,400 | 159.3 | 11.1 | 71 | 41.5 | 29 |
|--------------|---------|-------|------|----|------|----|

- UNSUPPORTED UNITS OVER 72" REQUIRE CENTER SUPPORT GABLE. ADD +C TO SKU & UPCHARGE OF \$198

|              |         |       |    |    |      |    |
|--------------|---------|-------|----|----|------|----|
| LEV-SB3678DS | \$1,427 | 175.6 | 12 | 77 | 41.5 | 29 |
|--------------|---------|-------|----|----|------|----|

|              |         |       |      |       |      |    |
|--------------|---------|-------|------|-------|------|----|
| LEV-SB3684DS | \$1,470 | 186.7 | 12.9 | 82.75 | 41.5 | 29 |
|--------------|---------|-------|------|-------|------|----|

|              |         |       |      |       |      |    |
|--------------|---------|-------|------|-------|------|----|
| LEV-SB3690DS | \$1,622 | 191.7 | 13.8 | 88.75 | 41.5 | 29 |
|--------------|---------|-------|------|-------|------|----|

|              |         |       |      |      |      |    |
|--------------|---------|-------|------|------|------|----|
| LEV-SB3696DS | \$1,776 | 202.8 | 14.7 | 94.5 | 41.5 | 29 |
|--------------|---------|-------|------|------|------|----|

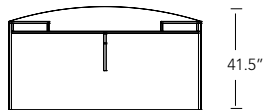
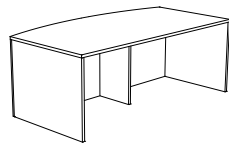

82.75"  
LEV-SB4284DS+C

|              |         |       |      |    |      |    |
|--------------|---------|-------|------|----|------|----|
| LEV-SB4272DS | \$1,513 | 178.4 | 11.9 | 71 | 41.5 | 29 |
|--------------|---------|-------|------|----|------|----|

- UNSUPPORTED UNITS OVER 72" REQUIRE CENTER SUPPORT GABLE. ADD +C TO SKU & UPCHARGE OF \$198

|              |         |       |      |    |      |    |
|--------------|---------|-------|------|----|------|----|
| LEV-SB4278DS | \$1,557 | 197.6 | 12.8 | 77 | 41.5 | 29 |
|--------------|---------|-------|------|----|------|----|

|              |         |       |      |       |      |    |
|--------------|---------|-------|------|-------|------|----|
| LEV-SB4284DS | \$1,582 | 209.6 | 13.8 | 82.75 | 41.5 | 29 |
|--------------|---------|-------|------|-------|------|----|

|              |         |       |      |       |      |    |
|--------------|---------|-------|------|-------|------|----|
| LEV-SB4290DS | \$1,738 | 215.6 | 14.7 | 88.75 | 41.5 | 29 |
|--------------|---------|-------|------|-------|------|----|

|              |         |       |      |      |      |    |
|--------------|---------|-------|------|------|------|----|
| LEV-SB4296DS | \$1,900 | 227.5 | 15.7 | 94.5 | 41.5 | 29 |
|--------------|---------|-------|------|------|------|----|

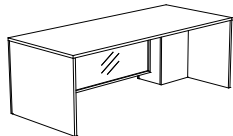

**DESK SHELL W/ EXTENDED PEDESTALS**

GLAZED MODESTY PANEL

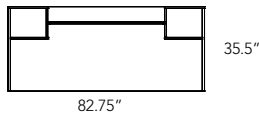

82.75"

|                 |         |       |   |    |      |    |
|-----------------|---------|-------|---|----|------|----|
| LEV-S3672DS-AGM | \$1,956 | 165.1 | 9 | 71 | 35.5 | 29 |
|-----------------|---------|-------|---|----|------|----|

- UNSUPPORTED UNITS OVER 72" REQUIRE CENTER SUPPORT GABLE. ADD +C TO SKU & UPCHARGE OF \$198

|                 |         |       |   |       |      |    |
|-----------------|---------|-------|---|-------|------|----|
| LEV-S3684DS-AGM | \$1,996 | 177.6 | 8 | 82.75 | 35.5 | 29 |
|-----------------|---------|-------|---|-------|------|----|

GLAZED PANEL FINISH: GLAZED MODESTY PANELS AVAILABLE IN CLEAR (CL), FROSTED (FR) OR BRONZE (BR) FINISH

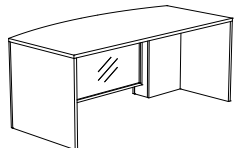

**BOW TOP DESK SHELL W/ EXTENDED PEDESTALS**

GLAZED MODESTY PANEL

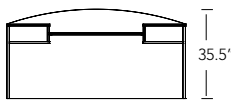

71"

|                  |         |       |   |    |      |    |
|------------------|---------|-------|---|----|------|----|
| LEV-SB3672DS-AGM | \$2,074 | 147.2 | 9 | 71 | 35.5 | 29 |
|------------------|---------|-------|---|----|------|----|

|                  |         |       |    |    |      |    |
|------------------|---------|-------|----|----|------|----|
| LEV-SB4272DS-AGM | \$2,116 | 172.3 | 10 | 71 | 41.5 | 29 |
|------------------|---------|-------|----|----|------|----|

GLAZED PANEL FINISH: GLAZED MODESTY PANELS AVAILABLE IN CLEAR (CL), FROSTED (FR) OR BRONZE (BR) FINISH

| MODEL | LIST | WEIGHT | CUBE            | W  | D  | H  |
|-------|------|--------|-----------------|----|----|----|
|       |      | LBS    | FT <sup>3</sup> | IN | IN | IN |

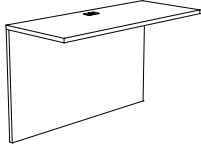

LEV-2048BR

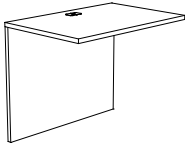

LEV-2436BR

**BRIDGE RETURN**

20" DEEP

|            |       |    |     |       |       |    |
|------------|-------|----|-----|-------|-------|----|
| LEV-2042BR | \$454 | 56 | 1.8 | 41.5  | 19.75 | 29 |
| LEV-2048BR | \$471 | 63 | 2   | 47.25 | 19.75 | 29 |

24" DEEP

|            |       |    |     |       |       |    |
|------------|-------|----|-----|-------|-------|----|
| LEV-2430BR | \$488 | 44 | 2   | 29.5  | 23.75 | 29 |
| LEV-2436BR | \$543 | 52 | 1.5 | 35.5  | 23.75 | 29 |
| LEV-2442BR | \$576 | 61 | 1.8 | 41.5  | 23.75 | 29 |
| LEV-2448BR | \$583 | 70 | 2   | 47.25 | 23.75 | 29 |

- ONE CENTERED GROMMET. INDICATE ON PO IF GROMMET IS NOT REQUIRED, NO EXTRA CHARGE

**NON-HANDED RETURN SHELL**

20" DEEP NON-HANDED, CAN BE INSTALLED LEFT OR RIGHT

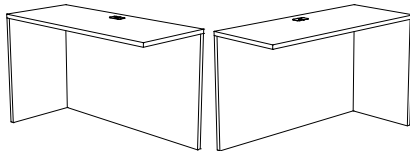

LEV-2048RS

|            |       |    |   |       |       |    |
|------------|-------|----|---|-------|-------|----|
| LEV-2030RS | \$551 | 50 | 2 | 29.5  | 19.75 | 29 |
| LEV-2036RS | \$566 | 57 | 2 | 35.5  | 19.75 | 29 |
| LEV-2042RS | \$594 | 63 | 2 | 41.5  | 19.75 | 29 |
| LEV-2048RS | \$606 | 69 | 2 | 47.25 | 19.75 | 29 |

24" DEEP NON-HANDED, CAN BE INSTALLED LEFT OR RIGHT

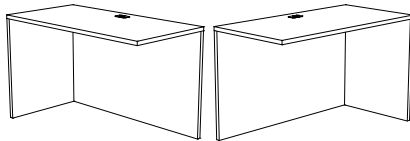

LEV-2448RS

|            |       |    |   |       |       |    |
|------------|-------|----|---|-------|-------|----|
| LEV-2430RS | \$576 | 50 | 2 | 29.5  | 23.75 | 29 |
| LEV-2436RS | \$598 | 57 | 2 | 35.5  | 23.75 | 29 |
| LEV-2442RS | \$639 | 63 | 2 | 41.5  | 23.75 | 29 |
| LEV-2448RS | \$655 | 69 | 2 | 47.25 | 23.75 | 29 |

- ONE CENTERED GROMMET. INDICATE ON PO IF GROMMET IS NOT REQUIRED, NO EXTRA CHARGE

**RTA**

# LEVELS SERIES CONNECTOR TOPS

| MODEL | LIST | WEIGHT | CUBE            | W  | D  | H  |
|-------|------|--------|-----------------|----|----|----|
|       |      | LBS    | FT <sup>3</sup> | IN | IN | IN |

## 24" CONNECTOR TOP

W/ FLUSH, FULL MODESTY PANEL. GABLE SETS ARE NON HANDED.

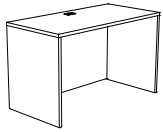

LEV-2448CT - GABLE SET "A"

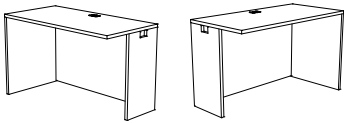

LEV-2448CT - GABLE SET "B"



LEV-2448CT - GABLE SET "C"

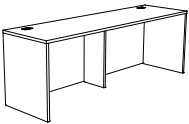

LEV-2484CT - GABLE SET "A"

|  |         |     |     |       |       |    |
|--|---------|-----|-----|-------|-------|----|
| LEV-2424CT   | \$577   | 60  | 1.6 | 23.75 | 23.75 | 29 |
| LEV-2430CT   | \$577   | 63  | 2   | 29.5  | 23.75 | 29 |
| LEV-2436CT   | \$615   | 68  | 2   | 35.5  | 23.75 | 29 |
| LEV-2442CT   | \$638   | 74  | 2.2 | 41.5  | 23.75 | 29 |
| LEV-2448CT   | \$672   | 80  | 2.5 | 47.25 | 23.75 | 29 |
| LEV-2454CT   | \$697   | 86  | 2.8 | 53.25 | 23.75 | 29 |
| LEV-2460CT   | \$716   | 92  | 3.1 | 59.25 | 23.75 | 29 |
| LEV-2466CT   | \$758   | 98  | 3.4 | 65    | 23.75 | 29 |
| LEV-2472CT   | \$801   | 104 | 3.7 | 71    | 23.75 | 29 |
| <ul style="list-style-type: none"> <li>UNSUPPORTED UNITS OVER 72" REQUIRE CENTER SUPPORT GABLE. ADD +C TO SKU &amp; UPCHARGE OF \$198</li> </ul> |         |     |     |       |       |    |
| LEV-2478CT   | \$946   | 140 | 4   | 77    | 23.75 | 29 |
| LEV-2484CT   | \$1,044 | 154 | 4.5 | 82.75 | 23.75 | 29 |
| LEV-2490CT   | \$1,138 | 170 | 5   | 88.75 | 23.75 | 29 |
| LEV-2496CT   | \$1,244 | 190 | 5.5 | 94.5  | 23.75 |    |

- ONE CENTERED GROMMET. INDICATE ON PO IF GROMMET IS NOT REQUIRED, NO EXTRA CHARGE

## 30" CONNECTOR TOP

W/ FLUSH, FULL MODESTY PANEL. GABLE SETS ARE NON HANDED.



LEV-3048CT - GABLE SET "A"

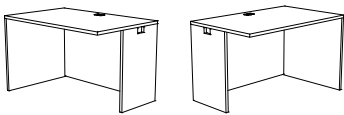

LEV-3048CT - GABLE SET "B"



LEV-3048CT - GABLE SET "C"

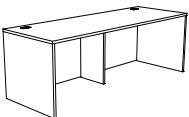





LEV-3084CT - GABLE SET "A"

|  |         |     |     |       |      |    |
|--|---------|-----|-----|-------|------|----|
| LEV-3030CT   | \$646   | 78  | 1.8 | 29.5  | 29.5 | 29 |
| LEV-3036CT   | \$683   | 84  | 2.1 | 35.5  | 29.5 | 29 |
| LEV-3042CT   | \$711   | 91  | 2.8 | 41.5  | 29.5 | 29 |
| LEV-3048CT   | \$734   | 97  | 3.6 | 47.25 | 29.5 | 29 |
| LEV-3054CT   | \$781   | 103 | 4   | 53.25 | 29.5 | 29 |
| 30" DEEP CONNECTORS OVER 54' WIDE RECEIVE 2 GROMMETS   |         |     |     |       |      |    |
| LEV-3060CT   | \$803   | 110 | 4.2 | 59.25 | 29.5 | 29 |
| LEV-3066CT   | \$837   | 117 | 4.7 | 65    | 29.5 | 29 |
| LEV-3072CT   | \$879   | 123 | 5.2 | 71    | 29.5 | 29 |
| <ul style="list-style-type: none"> <li>UNSUPPORTED UNITS OVER 72" REQUIRE CENTER SUPPORT GABLE. ADD +C TO SKU &amp; UPCHARGE OF \$198</li> </ul> |         |     |     |       |      |    |
| LEV-3078CT   | \$993   | 159 | 6.5 | 77    | 29.5 | 29 |
| LEV-3084CT   | \$1,118 | 173 | 7.5 | 82.75 | 29.5 | 29 |
| LEV-3090CT   | \$1,244 | 190 | 8   | 88.75 | 29.5 | 29 |
| LEV-3096CT   | \$1,352 | 209 | 8.5 | 94.5  | 29.5 | 29 |

- MUST BE ORDERED WITH A, B OR C GABLE SET - **ADD LETTER TO MODEL NUMBER**  
EXAMPLE: LEV-3048CT-**C**
- TO ORDER WITH 2.5" RECESSED, MODESTY PANEL - **ADD 'R' TO MODEL NUMBER**  
EXAMPLE: LEV-**R**3048CT-A
- TO ORDER WITH 1/2 OR 3/4 MODESTY PANEL - **ADD '2' (1/2) OR '3' (3/4) TO MODEL NUMBER**  
EXAMPLE: LEV-3048CT-A**2**

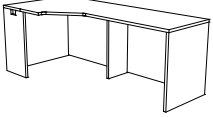
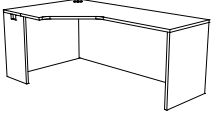
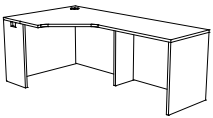
RTA

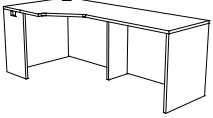
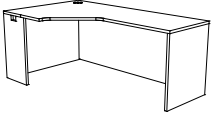
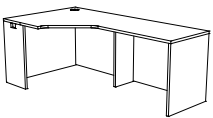
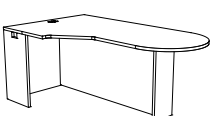

|   | MODEL  | LIST    | WEIGHT | CUBE            | W          | D         | H  |
|---|--|---------|--------|-----------------|------------|-----------|----|
|   |  |         | LBS    | FT <sup>3</sup> | IN         | IN        | IN |
|    | <b>RIGHT EXTENDED CORNER MODULE</b>  |         |        |                 |            |           |    |
|   | W/ FLUSH, FULL MODESTY PANEL   |         |        |                 |            |           |    |
| LEV-3672CM-B- GABLE SET "B"   | LEV-3666CM   | \$1,113 | 145    | 5.5             | 35.5/65    | 23.75     | 29 |
|    | LEV-3672CM   | \$1,168 | 155    | 6               | 35.5/71    | 23.75     | 29 |
| LEV-3678CM-B-C GABLE SET "B"  | • UNSUPPORTED UNITS OVER 72" REQUIRE CENTER SUPPORT GABLE. ADD +C TO SKU & UPCHARGE OF \$198                                   |         |        |                 |            |           |    |
|    | LEV-3678CM   | \$1,301 | 165    | 7               | 35.5/77    | 23.75     | 29 |
| LEV-4272CM-B - GABLE SET "B"  | LEV-3684CM   | \$1,532 | 175    | 7.5             | 35.5/82.75 | 23.75     | 29 |
|    | <b>LEFT EXTENDED CORNER MODULE</b>   |         |        |                 |            |           |    |
| LEV-4278CM-B-C - GABLE SET "B"  | W/ FLUSH, FULL MODESTY PANEL   |         |        |                 |            |           |    |
|   | LEV-6636CM   | \$1,113 | 145    | 5.5             | 65/35.5    | 23.75     | 29 |
| LEV-7236CM-B - GABLE SET "B"  | LEV-7236CM   | \$1,168 | 155    | 6               | 71/35.5    | 23.75     | 29 |
|  | • UNSUPPORTED UNITS OVER 72" REQUIRE CENTER SUPPORT GABLE. ADD +C TO SKU & UPCHARGE OF \$198                                   |         |        |                 |            |           |    |
| LEV-7836CM-B-C - GABLE SET "B"  | LEV-7836CM   | \$1,301 | 165    | 7               | 77/35.5    | 23.75     | 29 |
|  | LEV-8436CM   | \$1,532 | 175    | 7.5             | 82.75/35.5 | 23.75     | 29 |
| LEV-7242CM - B - GABLE SET "B"  | <b>CORNER MODULE BULLET</b>  |         |        |                 |            |           |    |
|  | RIGHT EXTENSION W/ FULL MODESTY PANEL & GABLE LEG  |         |        |                 |            |           |    |
| LEV-7842CM -B-C - GABLE SET "B"   | LEV-6642CM   | \$1,352 | 155    | 6               | 65/41.5    | 23.75     | 29 |
|  | LEV-7242CM   | \$1,421 | 165    | 7               | 71/41.5    | 23.75     | 29 |
| LEV-4272CMBTM-B - GABLE SET "B"   | • UNSUPPORTED UNITS OVER 72" REQUIRE CENTER SUPPORT GABLE. ADD +C TO SKU & UPCHARGE OF \$198                                   |         |        |                 |            |           |    |
|  | LEV-7842CM   | \$1,538 | 175    | 8               | 77/41.5    | 23.75     | 29 |
| LEV-7242CMBTM-B - GABLE SET "B"   | LEV-8442CM   | \$1,700 | 185    | 9               | 82.75/41.5 | 23.75     | 29 |
|   | LEFT EXTENSION W/ FULL MODESTY PANEL & GABLE LEG   |         |        |                 |            |           |    |
|   | LEV-7242CMBTM  | \$1,551 | 170    | 9               | 71/23.75   | 29.5/41.5 | 29 |
|   | • MUST BE ORDERED WITH A, B OR C GABLE SET - <b>ADD LETTER TO MODEL NUMBER</b><br>EXAMPLE: LEV-3672CM- <b>B</b>                |         |        |                 |            |           |    |
|   | • TO ORDER WITH 2.5" RECESSED, MODESTY PANEL - <b>ADD 'R' TO MODEL NUMBER</b><br>EXAMPLE: LEV- <b>R</b> 7836CM-A               |         |        |                 |            |           |    |
|   | • TO ORDER WITH 1/2 OR 3/4 MODESTY PANEL - <b>ADD '2' (1/2) OR '3' (3/4) TO MODEL NUMBER</b><br>EXAMPLE: LEV-8436CM-A <b>2</b> |         |        |                 |            |           |    |

RTA

# LEVELS SERIES

## PENINSULA TOPS

| MODEL | LIST | WEIGHT | CUBE            | W  | D  | H  |
|-------|------|--------|-----------------|----|----|----|
|       |      | LBS    | FT <sup>3</sup> | IN | IN | IN |



LEV-2466BT

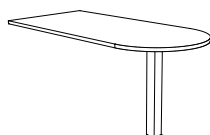

LEV-3066BT

47.25" - 59.25" - 65" - 71"

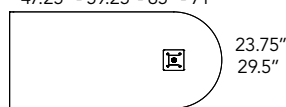

### BULLET TOP

24" DEEP W/ 3" SQUARE LEG

|            |       |    |     |       |       |    |
|------------|-------|----|-----|-------|-------|----|
| LEV-2448BT | \$587 | 45 | 4   | 47.25 | 23.75 | 29 |
| LEV-2460BT | \$629 | 50 | 4.2 | 59.25 | 23.75 | 29 |
| LEV-2466BT | \$650 | 55 | 4.2 | 65    | 23.75 | 29 |

30" DEEP W/ 3" SQUARE LEG

|            |       |    |     |       |      |    |
|------------|-------|----|-----|-------|------|----|
| LEV-3048BT | \$629 | 50 | 4.2 | 47.25 | 29.5 | 29 |
| LEV-3060BT | \$691 | 60 | 4.2 | 59.25 | 29.5 | 29 |
| LEV-3066BT | \$716 | 65 | 4.7 | 65    | 29.5 | 29 |
| LEV-3072BT | \$745 | 70 | 6.2 | 71    | 29.5 | 29 |

24" DEEP W/ FULL GABLE & 3" SQUARE LEG

|             |       |    |     |       |       |    |
|-------------|-------|----|-----|-------|-------|----|
| LEV-2448BTG | \$692 | 75 | 3.5 | 47.25 | 23.75 | 29 |
| LEV-2460BTG | \$729 | 80 | 4   | 59.25 | 23.75 | 29 |
| LEV-2466BTG | \$781 | 85 | 4   | 65    | 23.75 | 29 |

30" DEEP W/ FULL GABLE & 3" SQUARE LEG

|             |       |     |     |       |      |    |
|-------------|-------|-----|-----|-------|------|----|
| LEV-3048BTG | \$762 | 85  | 4   | 47.25 | 29.5 | 29 |
| LEV-3060BTG | \$772 | 95  | 4.2 | 59.25 | 29.5 | 29 |
| LEV-3066BTG | \$816 | 100 | 4.7 | 65    | 29.5 | 29 |
| LEV-3072BTG | \$871 | 105 | 6   | 71    | 29.5 | 29 |

36" DEEP W/ FULL GABLE & 3" SQUARE LEG

|             |       |     |   |    |      |    |
|-------------|-------|-----|---|----|------|----|
| LEV-3672BTG | \$935 | 115 | 7 | 71 | 35.5 | 29 |
|-------------|-------|-----|---|----|------|----|

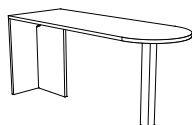

LEV-2466BTG

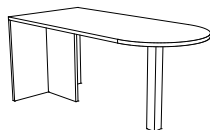

LEV-3066BTG

47.25" - 59.25" - 65" - 71"

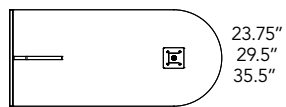

30" DEEP W/ FULL MODESTY & 3" SQUARE LEG

|              |       |     |     |       |      |    |
|--------------|-------|-----|-----|-------|------|----|
| LEV-3048BTGM | \$765 | 90  | 4   | 47.25 | 29.5 | 29 |
| LEV-3060BTGM | \$792 | 95  | 4.2 | 59.25 | 29.5 | 29 |
| LEV-3066BTGM | \$873 | 110 | 4.7 | 65    | 29.5 | 29 |
| LEV-3072BTGM | \$931 | 120 | 6.2 | 71    | 29.5 | 29 |

36" DEEP W/ FULL MODESTY & 3" SQUARE LEG

|              |       |     |   |    |      |    |
|--------------|-------|-----|---|----|------|----|
| LEV-3672BTGM | \$951 | 135 | 7 | 71 | 35.5 | 29 |
|--------------|-------|-----|---|----|------|----|

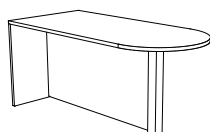

LEV-3066BTGM

47.25" - 59.25" - 65" - 71"

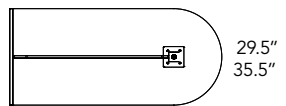

- NO GROMMET IN WORK SURFACE
- TO ORDER WITH ½ OR ¾ MODESTY PANEL - ADD '2' (½) OR '3' (¾) TO MODEL NUMBER  
**EXAMPLE:** LEV-3672BTGM-2
- DEFAULT LEG IS 3" SQUARE. PLEASE INDICATE FINISH CHOICE CLEARLY ON PO. LEG SUBSTITUTIONS AVAILABLE SEE [LEV-3](#)

METAL LEG  
FINISHES

BLACK (BL), SILVER (SL) OR WHITE (WH)

RTA

| MODEL | LIST | WEIGHT | CUBE            | W  | D  | H  |
|-------|------|--------|-----------------|----|----|----|
|       |      | LBS    | FT <sup>3</sup> | IN | IN | IN |

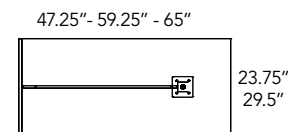
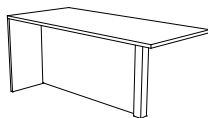
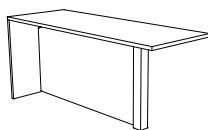
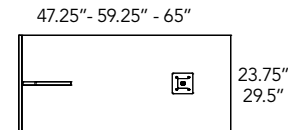
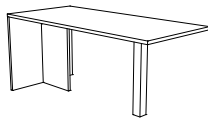
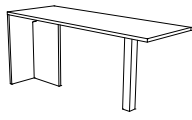
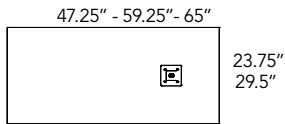
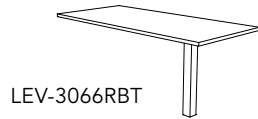
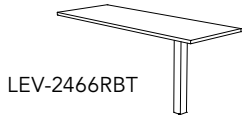

**RTA**

**RECTANGULAR BULLET TOP**

24" DEEP W/ 3" SQUARE LEG

|             |       |    |     |       |       |    |
|-------------|-------|----|-----|-------|-------|----|
| LEV-2448RBT | \$603 | 47 | 4   | 47.25 | 23.75 | 29 |
| LEV-2460RBT | \$626 | 52 | 4.2 | 59.25 | 23.75 | 29 |
| LEV-2466RBT | \$650 | 57 | 4.2 | 65    | 23.75 | 29 |

30" DEEP W/ 3" SQUARE LEG

|             |       |    |     |       |      |    |
|-------------|-------|----|-----|-------|------|----|
| LEV-3048RBT | \$653 | 52 | 4.2 | 47.5  | 29.5 | 29 |
| LEV-3060RBT | \$694 | 57 | 4.4 | 59.25 | 29.5 | 29 |
| LEV-3066RBT | \$851 | 62 | 4.4 | 65    | 29.5 | 29 |

24" DEEP W/ FULL GABLE & 3" SQUARE LEG

|              |       |    |     |       |       |    |
|--------------|-------|----|-----|-------|-------|----|
| LEV-2448RBTG | \$657 | 87 | 4   | 47.25 | 23.75 | 29 |
| LEV-2460RBTG | \$713 | 92 | 4.2 | 59.25 | 23.75 | 29 |
| LEV-2466RBTG | \$757 | 97 | 4.2 | 65    | 23.75 | 29 |

24" DEEP W/ FULL GABLE & 3" SQUARE LEG

|              |       |     |     |       |      |    |
|--------------|-------|-----|-----|-------|------|----|
| LEV-3048RBTG | \$784 | 92  | 4.2 | 47.25 | 29.5 | 29 |
| LEV-3060RBTG | \$822 | 100 | 4.4 | 59.25 | 29.5 | 29 |
| LEV-3066RBTG | \$888 | 106 | 4.4 | 65    | 29.5 | 29 |

24" DEEP W/ FULL MODESTY & 3" SQUARE LEG

|               |       |     |     |       |       |    |
|---------------|-------|-----|-----|-------|-------|----|
| LEV-2448RBTGM | \$670 | 92  | 4   | 47.25 | 23.75 | 29 |
| LEV-2460RBTGM | \$694 | 97  | 4.2 | 59.25 | 23.75 | 29 |
| LEV-2466RBTGM | \$762 | 102 | 4.2 | 65    | 23.75 | 29 |

24" DEEP W/ FULL MODESTY & 3" SQUARE LEG

|               |       |     |     |       |      |    |
|---------------|-------|-----|-----|-------|------|----|
| LEV-3048RBTGM | \$697 | 97  | 4.2 | 47.25 | 29.5 | 29 |
| LEV-3060RBTGM | \$800 | 112 | 4.4 | 59.25 | 29.5 | 29 |
| LEV-3066RBTGM | \$900 | 117 | 4.4 | 65    | 29.5 | 29 |

- NO GROMMET IN WORK SURFACE
- TO ORDER WITH 1/2 OR 3/4 MODESTY PANEL - ADD '2' (1/2) OR '3' (3/4) TO MODEL NUMBER  
**EXAMPLE:** LEV-3672RBTGM-2
- DEFAULT LEG IS 3" SQUARE. PLEASE INDICATE FINISH CHOICE CLEARLY ON PO. LEG SUBSTITUTIONS AVAILABLE SEE **LEV-3**

**METAL LEG FINISHES**

BLACK (BL), SILVER (SL) OR WHITE (WH)

**LEVELS SERIES**  
**PENINSULA TOPS**

| MODEL | LIST | WEIGHT | CUBE            | W  | D  | H  |
|-------|------|--------|-----------------|----|----|----|
|       |      | LBS    | FT <sup>3</sup> | IN | IN | IN |



LEV-3066PT-L

**PENINSULA TOP - LEFT**

24" DEEP W/ 3" SQUARE LEG

|                           |              |             |            |              |                   |           |
|---------------------------|--------------|-------------|------------|--------------|-------------------|-----------|
| <b>LEV-2448PT-L</b>       | <b>\$676</b> | <b>43.8</b> | <b>4.5</b> | <b>47.25</b> | <b>29.5/23.75</b> | <b>29</b> |
| <b>LEV-2460PT-L</b>       | <b>\$716</b> | <b>50.9</b> | <b>4.8</b> | <b>59.25</b> | <b>29.5/23.75</b> | <b>29</b> |
| 30" DEEP W/ 3" SQUARE LEG |              |             |            |              |                   |           |
| <b>LEV-3060PT-L</b>       | <b>\$781</b> | <b>59.4</b> | <b>4.8</b> | <b>59.25</b> | <b>35.5/29.5</b>  | <b>29</b> |
| <b>LEV-3066PT-L</b>       | <b>\$802</b> | <b>63.9</b> | <b>5.2</b> | <b>65</b>    | <b>35.5/29.5</b>  | <b>29</b> |
| <b>LEV-3072PT-L</b>       | <b>\$835</b> | <b>68.3</b> | <b>6</b>   | <b>71</b>    | <b>35.5/29.5</b>  | <b>29</b> |

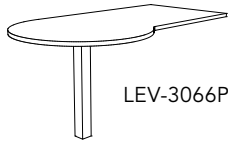
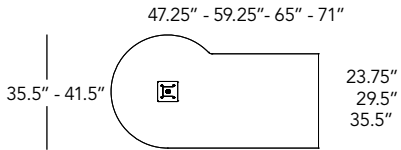

LEV-3066PT-R

**PENINSULA TOP - RIGHT**

24" DEEP W/ 3" SQUARE LEG

|                           |              |             |            |              |                   |           |
|---------------------------|--------------|-------------|------------|--------------|-------------------|-----------|
| <b>LEV-2448PT-R</b>       | <b>\$676</b> | <b>43.8</b> | <b>4.5</b> | <b>47.25</b> | <b>23.75/29.5</b> | <b>29</b> |
| <b>LEV-2460PT-R</b>       | <b>\$716</b> | <b>80</b>   | <b>4.8</b> | <b>59.25</b> | <b>23.75/29.5</b> | <b>29</b> |
| 30" DEEP W/ 3" SQUARE LEG |              |             |            |              |                   |           |
| <b>LEV-3060PT-R</b>       | <b>\$781</b> | <b>59.4</b> | <b>4.8</b> | <b>59.25</b> | <b>29.5/35.5</b>  | <b>29</b> |
| <b>LEV-3066PT-R</b>       | <b>\$802</b> | <b>63.9</b> | <b>5.2</b> | <b>65</b>    | <b>29.5/35.5</b>  | <b>29</b> |
| <b>LEV-3072PT-R</b>       | <b>\$835</b> | <b>68.3</b> | <b>6</b>   | <b>71</b>    | <b>29.5/35.5</b>  | <b>29</b> |

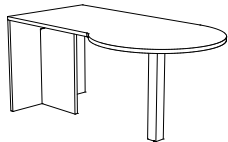
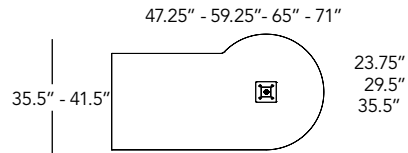

LEV-3066PTG-L

**PENINSULA TOP - LEFT**

30" DEEP W/ FULL GABLE & 3" SQUARE LEG

|                      |                |             |            |              |                  |           |
|----------------------|----------------|-------------|------------|--------------|------------------|-----------|
| <b>LEV-3060PTG-L</b> | <b>\$816</b>   | <b>90.5</b> | <b>6</b>   | <b>59.25</b> | <b>29.5/35.5</b> | <b>29</b> |
| <b>LEV-3066PTG-L</b> | <b>\$1,031</b> | <b>95</b>   | <b>6.5</b> | <b>65</b>    | <b>29.5/35.5</b> | <b>29</b> |
| <b>LEV-3072PTG-L</b> | <b>\$1,081</b> | <b>99.5</b> | <b>7</b>   | <b>71</b>    | <b>29.5/35.5</b> | <b>29</b> |

36" DEEP W/ FULL GABLE & 3" SQUARE LEG

|                      |                |              |            |           |                  |           |
|----------------------|----------------|--------------|------------|-----------|------------------|-----------|
| <b>LEV-3672PTG-L</b> | <b>\$1,113</b> | <b>113.6</b> | <b>7.5</b> | <b>71</b> | <b>35.5/41.5</b> | <b>29</b> |
|----------------------|----------------|--------------|------------|-----------|------------------|-----------|

**PENINSULA TOP - RIGHT**

30" DEEP W/ FULL GABLE & 3" SQUARE LEG

|                      |                |             |            |              |                  |           |
|----------------------|----------------|-------------|------------|--------------|------------------|-----------|
| <b>LEV-3060PTG-R</b> | <b>\$984</b>   | <b>90.5</b> | <b>6</b>   | <b>59.25</b> | <b>29.5/35.5</b> | <b>29</b> |
| <b>LEV-3066PTG-R</b> | <b>\$1,031</b> | <b>95.0</b> | <b>6.5</b> | <b>65</b>    | <b>29.5/35.5</b> | <b>29</b> |
| <b>LEV-3072PTG-R</b> | <b>\$1,081</b> | <b>99.5</b> | <b>7</b>   | <b>71</b>    | <b>29.5/35.5</b> | <b>29</b> |

36" DEEP W/ FULL GABLE & 3" SQUARE LEG

|                      |                |              |            |           |                  |           |
|----------------------|----------------|--------------|------------|-----------|------------------|-----------|
| <b>LEV-3672PTG-R</b> | <b>\$1,113</b> | <b>113.6</b> | <b>7.5</b> | <b>71</b> | <b>35.5/41.5</b> | <b>29</b> |
|----------------------|----------------|--------------|------------|-----------|------------------|-----------|



LEV-3066PTG-R

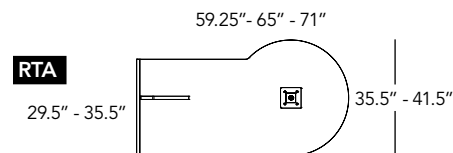

- NO GROMMET IN WORK SURFACE
- DEFAULT LEG IS 3" SQUARE. PLEASE INDICATE FINISH CHOICE CLEARLY ON PO. LEG SUBSTITUTIONS AVAILABLE SEE [LEV-3](#)

**METAL LEG FINISHES** BLACK (BL), SILVER (SL) OR WHITE (WH)

| MODEL | LIST | WEIGHT | CUBE            | W  | D  | H  |
|-------|------|--------|-----------------|----|----|----|
|       |      | LBS    | FT <sup>3</sup> | IN | IN | IN |

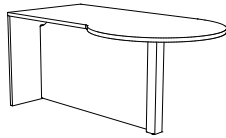

LEV-3066PTGM-L

**PENINSULA TOP - LEFT**

30" DEEP W/ FULL MODESTY PANEL & 3" SQUARE LEG

|                |         |       |     |       |           |    |
|----------------|---------|-------|-----|-------|-----------|----|
| LEV-3060PTGM-L | \$977   | 99.4  | 6   | 59.25 | 35.5/29.5 | 29 |
| LEV-3066PTGM-L | \$1,026 | 106.9 | 6   | 65    | 35.5/29.5 | 29 |
| LEV-3072PTGM-L | \$1,081 | 114.3 | 6.5 | 71    | 35.5/29.5 | 29 |

36" DEEP W/ FULL MODESTY PANEL & 3" SQUARE LEG

|                |         |       |   |    |           |    |
|----------------|---------|-------|---|----|-----------|----|
| LEV-3672PTGM-L | \$1,105 | 127.1 | 7 | 71 | 41.5/35.5 | 29 |
|----------------|---------|-------|---|----|-----------|----|

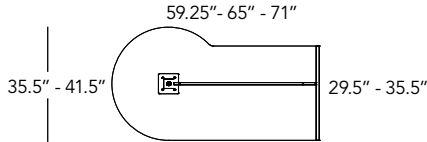

**PENINSULA TOP - RIGHT**

30" DEEP W/ FULL MODESTY PANEL & 3" SQUARE LEG

|                |         |       |     |       |           |    |
|----------------|---------|-------|-----|-------|-----------|----|
| LEV-3060PTGM-R | \$977   | 99.4  | 6   | 59.25 | 29.5/35.5 | 29 |
| LEV-3066PTGM-R | \$1,026 | 106.9 | 6   | 65    | 29.5/35.5 | 29 |
| LEV-3072PTGM-R | \$1,081 | 114.3 | 6.5 | 71    | 29.5/35.5 | 29 |

36" DEEP W/ FULL MODESTY PANEL & 3" SQUARE LEG

|                |         |       |   |    |           |    |
|----------------|---------|-------|---|----|-----------|----|
| LEV-3672PTGM-R | \$1,105 | 127.1 | 7 | 71 | 35.5/41.5 | 29 |
|----------------|---------|-------|---|----|-----------|----|

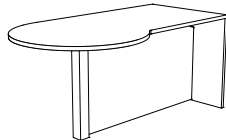

LEV-3066PTGM-R

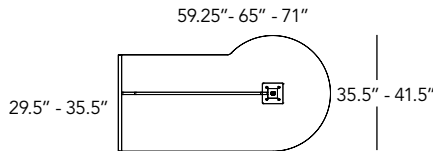

- NO GROMMET IN WORK SURFACE
- TO ORDER WITH 1/2 OR 3/4 MODESTY PANEL - ADD '2' (1/2) OR '3' (3/4) TO MODEL NUMBER  
**EXAMPLE:** LEV-3672PTGM-R-2
- DEFAULT LEG IS 3" SQUARE. PLEASE INDICATE FINISH CHOICE CLEARLY ON PO. LEG SUBSTITUTIONS AVAILABLE SEE [LEV-3](#)

**RTA**

**METAL LEG  
FINISHES**

BLACK (BL), SILVER (SL) OR WHITE (WH)

| MODEL | LIST | WEIGHT | CUBE            | W  | D  | H  |
|-------|------|--------|-----------------|----|----|----|
|       |      | LBS    | FT <sup>3</sup> | IN | IN | IN |

**LAMINATE MODESTY PANELS**

½ HEIGHT MODESTY PANELS - SUSPENDED

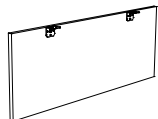

LEV-1436LMPS

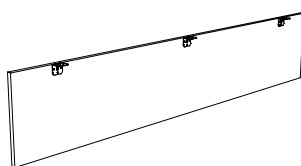

LEV-1472LMPS

|              |       |      |      |       |      |      |
|--------------|-------|------|------|-------|------|------|
| LEV-1424LMPS | \$172 | 6.7  | 0.2  | 23.75 | 0.75 | 13.5 |
| LEV-1430LMPS | \$175 | 8.3  | 0.2  | 29.5  | 0.75 | 13.5 |
| LEV-1436LMPS | \$189 | 9.8  | 0.2  | 35.5  | 0.75 | 13.5 |
| LEV-1442LMPS | \$215 | 11.4 | 0.3  | 41.5  | 0.75 | 13.5 |
| LEV-1448LMPS | \$222 | 12.9 | 0.3  | 47.25 | 0.75 | 13.5 |
| LEV-1454LMPS | \$227 | 14.5 | 0.3  | 53.25 | 0.75 | 13.5 |
| LEV-1460LMPS | \$241 | 16   | 0.4  | 59.25 | 0.75 | 13.5 |
| LEV-1466LMPS | \$262 | 18.7 | 0.72 | 65    | 0.75 | 13.5 |
| LEV-1472LMPS | \$294 | 20.8 | 0.8  | 71    | 0.75 | 13.5 |
| LEV-1478LMPS | \$332 | 22.9 | 0.87 | 77    | 0.75 | 13.5 |
| LEV-1484LMPS | \$387 | 25   | 0.95 | 82.75 | 0.75 | 13.5 |
| LEV-1490LMPS | \$427 | 27.1 | 1.03 | 88.75 | 0.75 | 13.5 |
| LEV-1496LMPS | \$488 | 29.1 | 1.1  | 94.5  | 0.75 | 13.5 |

- INCLUDES ALL MOUNTING HARDWARE

AVAILABLE FINISHES

ALL STANDARD HEARTWOOD LAMINATE FINISHES

**PLEXI MODESTY PANELS**

½ HEIGHT MODESTY PANELS - SUSPENDED

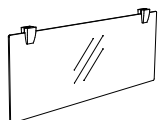

LEV-1436PMPS

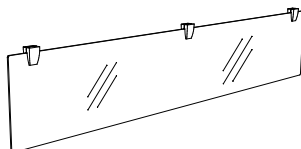

LEV-1472PMPS

|              |       |      |      |       |      |      |
|--------------|-------|------|------|-------|------|------|
| LEV-1424PMPS | \$241 | 3.6  | 0.38 | 23.75 | 0.25 | 13.5 |
| LEV-1430PMPS | \$260 | 4.5  | 0.47 | 29.5  | 0.25 | 13.5 |
| LEV-1436PMPS | \$299 | 5.4  | 0.55 | 35.5  | 0.25 | 13.5 |
| LEV-1442PMPS | \$368 | 6.4  | 0.64 | 41.5  | 0.25 | 13.5 |
| LEV-1448PMPS | \$477 | 7.2  | 0.72 | 47.25 | 0.25 | 13.5 |
| LEV-1454PMPS | \$497 | 8.2  | 0.8  | 53.25 | 0.25 | 13.5 |
| LEV-1460PMPS | \$525 | 9.1  | 0.89 | 59.25 | 0.25 | 13.5 |
| LEV-1466PMPS | \$546 | 10   | 0.97 | 65    | 0.25 | 13.5 |
| LEV-1472PMPS | \$605 | 10.9 | 1.06 | 71    | 0.25 | 13.5 |
| LEV-1478PMPS | \$667 | 11.8 | 1.14 | 77    | 0.25 | 13.5 |
| LEV-1484PMPS | \$701 | 12.7 | 1.22 | 82.75 | 0.25 | 13.5 |
| LEV-1490PMPS | \$725 | 13.6 | 1.31 | 88.75 | 0.25 | 13.5 |
| LEV-1496PMPS | \$740 | 14.5 | 1.39 | 94.5  | 0.25 | 13.5 |

- INCLUDES ALL MOUNTING HARDWARE

AVAILABLE FINISHES

CLEAR (CL), BRONZE (BR) & FROSTED (FR)

**RTA**

| MODEL | LIST | WEIGHT | CUBE            | W  | D  | H  |
|-------|------|--------|-----------------|----|----|----|
|       |      | LBS    | FT <sup>3</sup> | IN | IN | IN |

**PLEXI MODESTY/DIVIDER PANELS**

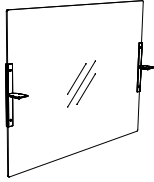

LEV-2836PMPDS

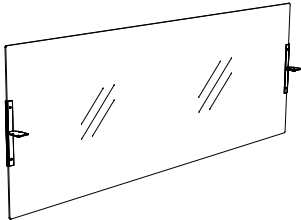

LEV-2872PMPDS

MODESTY PANEL/DIVIDER - SUSPENDED

|               |       |      |      |       |      |      |
|---------------|-------|------|------|-------|------|------|
| LEV-2824PMPDS | \$411 | 8.2  | 0.38 | 23.75 | 0.25 | 26.5 |
| LEV-2830PMPDS | \$417 | 9.2  | 0.4  | 29.5  | 0.25 | 26.5 |
| LEV-2836PMPDS | \$477 | 10.2 | 0.47 | 35.5  | 0.25 | 26.5 |
| LEV-2842PMPDS | \$541 | 14.3 | 0.64 | 41.5  | 0.25 | 26.5 |
| LEV-2848PMPDS | \$613 | 16.3 | 0.72 | 47.25 | 0.25 | 26.5 |
| LEV-2854PMPDS | \$676 | 18.4 | 0.8  | 53.25 | 0.25 | 26.5 |
| LEV-2860PMPDS | \$741 | 20.4 | 0.89 | 59.25 | 0.25 | 26.5 |
| LEV-2866PMPDS | \$813 | 22.4 | 0.97 | 65    | 0.25 | 26.5 |
| LEV-2872PMPDS | \$855 | 24.5 | 1.06 | 71    | 0.25 | 26.5 |
| LEV-2878PMPDS | \$868 | 26.6 | 1.14 | 77    | 0.25 | 26.5 |
| LEV-2884PMPDS | \$918 | 28.6 | 1.22 | 82.75 | 0.25 | 26.5 |
| LEV-2890PMPDS | \$942 | 30.6 | 1.31 | 88.75 | 0.25 | 26.5 |
| LEV-2896PMPDS | \$993 | 32.6 | 1.39 | 94.5  | 0.25 | 26.5 |

- INCLUDES ALL MOUNTING HARDWARE
- CONTACT CUSTOMER SERVICE FOR SIZING WHEN PAIRING WITH LOOP LEGS

AVAILABLE FINISHES

CLEAR (CL), BRONZE (BR) & FROSTED (FR)

**PLEXI DIVIDER PANELS**

WORK SURFACE MOUNT DIVIDER PANELS

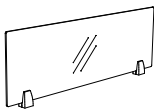

LEV-1236PDP

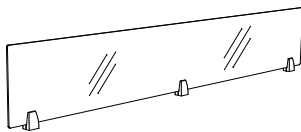

LEV-1272PDP

|             |       |     |      |       |      |    |
|-------------|-------|-----|------|-------|------|----|
| LEV-1224PDP | \$241 | 1.6 | 0.1  | 23.75 | 0.25 | 12 |
| LEV-1230PDP | \$260 | 2   | 0.12 | 29.5  | 0.25 | 12 |
| LEV-1236PDP | \$299 | 2.5 | 0.14 | 35.5  | 0.25 | 12 |
| LEV-1242PDP | \$332 | 2.9 | 0.16 | 41.5  | 0.25 | 12 |
| LEV-1248PDP | \$411 | 3.3 | 0.18 | 47.25 | 0.25 | 12 |
| LEV-1254PDP | \$436 | 3.7 | 0.2  | 53.25 | 0.25 | 12 |
| LEV-1260PDP | \$471 | 4.1 | 0.23 | 59.25 | 0.25 | 12 |
| LEV-1266PDP | \$509 | 4.5 | 0.25 | 65    | 0.25 | 12 |
| LEV-1272PDP | \$567 | 4.9 | 0.27 | 71    | 0.25 | 12 |
| LEV-1278PDP | \$631 | 5.3 | 0.29 | 77    | 0.25 | 12 |
| LEV-1284PDP | \$664 | 5.7 | 0.31 | 82.75 | 0.25 | 12 |
| LEV-1290PDP | \$689 | 6.2 | 0.33 | 88.75 | 0.25 | 12 |
| LEV-1296PDP | \$701 | 6.6 | 0.35 | 94.5  | 0.25 | 12 |

- INCLUDES ALL MOUNTING HARDWARE

AVAILABLE FINISHES

CLEAR (CL), BRONZE (BR) & FROSTED (FR)

**RTA**

| MODEL | LIST | WEIGHT | CUBE            | W  | D  | H  |
|-------|------|--------|-----------------|----|----|----|
|       |      | LBS    | FT <sup>3</sup> | IN | IN | IN |



LEV-HPB

**DRAWER PEDESTALS**

**ATTENTION:** NO-TOP PEDESTALS WILL NEED TO BE INSET FROM METAL LEGS IN ORDER TO CLEAR THE PLATE WIDTH OF LEG. PEDESTALS USED AS WORK SURFACE SUPPORT DO NOT NEED TO BE INSET IF NOT COMBINED WITH A METAL LEG.



LEV-HPU

**HANGING PEDESTAL**

BOX, NO LOCK

|         |       |    |     |       |       |   |
|---------|-------|----|-----|-------|-------|---|
| LEV-HPB | \$440 | 20 | 1.5 | 15.75 | 18.75 | 7 |
|---------|-------|----|-----|-------|-------|---|



LEV-HPF

**HANGING PEDESTAL**

BOX/BOX/BOX, ALL DRAWERS LOCK

|         |       |    |     |       |       |      |
|---------|-------|----|-----|-------|-------|------|
| LEV-HPU | \$753 | 70 | 4.2 | 15.75 | 18.75 | 20.5 |
|---------|-------|----|-----|-------|-------|------|

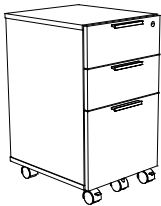

LEV-1627MPUF

**HANGING PEDESTAL**

BOX/FILE, ALL DRAWERS LOCK

|         |       |    |     |       |       |      |
|---------|-------|----|-----|-------|-------|------|
| LEV-HPF | \$752 | 65 | 4.2 | 15.75 | 18.75 | 20.5 |
|---------|-------|----|-----|-------|-------|------|

**MOBILE PEDESTAL**

BOX/BOX/FILE, ALL DRAWERS LOCK.

|              |       |    |     |    |       |      |
|--------------|-------|----|-----|----|-------|------|
| LEV-1627MPUF | \$965 | 85 | 5.8 | 16 | 18.75 | 27.5 |
|--------------|-------|----|-----|----|-------|------|

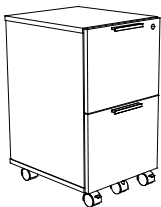

LEV-1627MPFF

**MOBILE PEDESTAL**

FILE/FILE, ALL DRAWERS LOCK.

|              |         |    |     |    |       |      |
|--------------|---------|----|-----|----|-------|------|
| LEV-1627MPFF | \$1,002 | 85 | 5.8 | 16 | 18.75 | 27.5 |
|--------------|---------|----|-----|----|-------|------|



LEV-1622MPF

**MOBILE PEDESTAL**

BOX/FILE, ALL DRAWERS LOCK.

|             |       |    |     |    |       |      |
|-------------|-------|----|-----|----|-------|------|
| LEV-1622MPF | \$834 | 65 | 4.5 | 16 | 18.75 | 21.5 |
|-------------|-------|----|-----|----|-------|------|

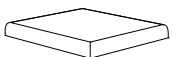

LEV-MPDCUSH

**OPTIONAL PEDESTAL CUSHION**

USE ON 21" HIGH MOBILE PEDESTALS **ONLY**

|                 |       |   |   |    |    |   |
|-----------------|-------|---|---|----|----|---|
| LEV-MPDCUSH-ESC | \$393 | 4 | 1 | 16 | 18 | 2 |
| LEV-MPDCUSH-HEA | \$424 | 4 | 1 | 16 | 18 | 2 |
| LEV-MPDCUSH-ULT | \$456 | 4 | 1 | 16 | 18 | 2 |

**ESCAPE** - 100% POLYESTER, JACQUARD WOVEN  
 - 100% POLYESTER, SOLID PLAIN WEAVE

**HEAVENLY** - 20% RAYON 80% POLYESTER, SOLID PLAIN WEAVE

**ULTRALEATHER** - 100% POLYVINYL CHLORIDE, FAUX LEATHER, ANTI-BACTERIAL

LEV-1622MPF &  
 LEV-MPDCUSH-ESC



**NOTES:** PLEASE REFER TO THE FINISHES & FABRICS TAB ON THE WWW.HEARTWOOD.CA WEBSITE FOR A COMPLETE LISTING OF THE COLOUR CHOICES AVAILABLE IN EACH FABRIC. CONTACT CUSTOMER SERVICE IF TWO SEAT CUSHIONS ARE REQUIRED TO BE SIDE BY SIDE AS SIZING MAY NEED TO BE ADJUSTED.



| MODEL | LIST | WEIGHT | CUBE            | W  | D  | H  |
|-------|------|--------|-----------------|----|----|----|
|       |      | LBS    | FT <sup>3</sup> | IN | IN | IN |

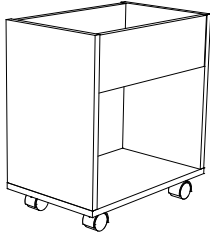

**MOBILE STORAGE OPEN**

|                       |              |             |            |              |           |           |
|-----------------------|--------------|-------------|------------|--------------|-----------|-----------|
| <b>LEV-1320MSO-22</b> | <b>\$743</b> | <b>25.2</b> | <b>3.2</b> | <b>19.75</b> | <b>13</b> | <b>22</b> |
|-----------------------|--------------|-------------|------------|--------------|-----------|-----------|

- WITH 2 LOCKING & 2 NON-LOCKING CASTORS

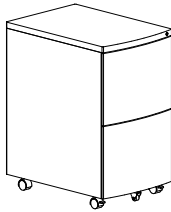

**METAL MOBILE PEDESTAL - FULL CARTON**

FILE / FILE PEDESTAL. ALL DRAWERS LOCK. LOCKING CASTERS.

|                  |              |           |          |             |             |             |
|------------------|--------------|-----------|----------|-------------|-------------|-------------|
| <b>100-MMPFF</b> | <b>\$540</b> | <b>55</b> | <b>7</b> | <b>15.5</b> | <b>22.5</b> | <b>27.1</b> |
|------------------|--------------|-----------|----------|-------------|-------------|-------------|

**METAL PEDESTAL FINISHES:** BLACK (BL), TITANIUM (TT) & WHITE (WH)

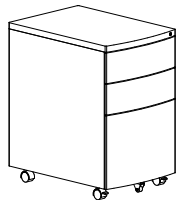

BOX / BOX / FILE PEDESTAL. ALL DRAWERS LOCK. LOCKING CASTERS.

|                  |              |           |          |             |             |             |
|------------------|--------------|-----------|----------|-------------|-------------|-------------|
| <b>100-MMPUF</b> | <b>\$540</b> | <b>55</b> | <b>7</b> | <b>15.5</b> | <b>22.5</b> | <b>25.2</b> |
|------------------|--------------|-----------|----------|-------------|-------------|-------------|

**METAL PEDESTAL FINISHES:** BLACK (BL), TITANIUM (TT) & WHITE (WH)

- FOR KEYED ALIKE CORE PACKS ADD 100-COREPACK. INCLUDES 1 CORE, 1 CORE REMOVAL KEY AND TWO LOCK KEYS.

**EXAMPLE:** IF YOU REQUIRE 3 UNITS TO BE KEYED-ALIKE, ORDER **100-COREPACK-3 (\$11 X 3 = \$33)**.

**NOTE: WE DO NOT RECOMMEND SITTING ON 100-MMPFF OR 100-MMPUF METAL MOBILE PEDESTALS.**

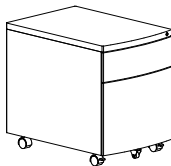

BOX / FILE PEDESTAL. ALL DRAWERS LOCK. LOCKING CASTERS.

|                 |              |             |             |             |             |             |
|-----------------|--------------|-------------|-------------|-------------|-------------|-------------|
| <b>100-MMPF</b> | <b>\$499</b> | <b>39.7</b> | <b>4.62</b> | <b>15.5</b> | <b>22.5</b> | <b>20.5</b> |
|-----------------|--------------|-------------|-------------|-------------|-------------|-------------|

- MEETS & EXCEEDS ANSI/BIFMA STANDARDS.
- MAXIMUM ADDITIONAL WEIGHT CAPACITY - 220LBS (HEAVY-DUTY CASTERS)
- INCLUDES PENCIL TRAY
- METAL MOBILE PEDESTALS CAN BE KEYED ALIKE: ORDER 100-COREPACK FOR THE NUMBER OF KEYED ALIKE UNITS REQUIRED.

**METAL PEDESTAL FINISHES:** BLACK (BL) & TITANIUM (TT)

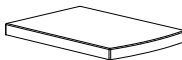

**NOT FOR USE WITH:**  
100-MMPUF  
100-MMPFF

**METAL MOBILE PEDESTAL CUSHION**

FOR USE WITH 100-MMPF **ONLY**

|                        |              |            |             |              |             |          |
|------------------------|--------------|------------|-------------|--------------|-------------|----------|
| <b>100-MMPF-CUSHFA</b> | <b>\$133</b> | <b>7.7</b> | <b>0.49</b> | <b>15.25</b> | <b>22.5</b> | <b>2</b> |
|------------------------|--------------|------------|-------------|--------------|-------------|----------|

**AVAILABLE SEAT CUSHION FINISH:** **CUSHFA** - BLACK (BL), BLUE (BU), LIGHT GREY (GR), RED (RD) & ORANGE (OR)

|                        |              |            |             |              |             |          |
|------------------------|--------------|------------|-------------|--------------|-------------|----------|
| <b>100-MMPF-CUSHPU</b> | <b>\$133</b> | <b>7.7</b> | <b>0.49</b> | <b>15.25</b> | <b>22.5</b> | <b>2</b> |
|------------------------|--------------|------------|-------------|--------------|-------------|----------|

**AVAILABLE SEAT CUSHION FINISH:** **CUSHPU** - BLACK POLYURETHANE (BL)

- CUSHIONS ATTACH WITH VELCRO STRIPS (SUPPLIED).
- 1 CUSHION PER CARTON.

# LEVELS SERIES

## 20" DEEP FREESTANDING PEDESTALS - NO TOP

|  | MODEL   | LIST  | WEIGHT | CUBE            | W     | D     | H  |
|--|---|-------|--------|-----------------|-------|-------|----|
|  |   |       | LBS    | FT <sup>3</sup> | IN    | IN    | IN |
|  | <b>ATTENTION:</b> NO-TOP PEDESTALS WILL NEED TO BE INSET FROM METAL LEGS IN ORDER TO CLEAR THE PLATE WIDTH OF LEG. PEDESTALS USED AS WORK SURFACE SUPPORT DO NOT NEED TO BE INSET IF NOT COMBINED WITH A METAL LEG. |       |        |                 |       |       |    |
|  | <b>FREESTANDING PEDESTAL - NO TOP</b><br>BOX/BOX/FILE, ALL DRAWERS LOCK   |       |        |                 |       |       |    |
|  | LEV-20FPUFX   | \$871 | 70     | 5.8             | 15.75 | 19.75 | 28 |
|  | <b>FREESTANDING PEDESTAL - NO TOP</b><br>FILE/FILE, ALL DRAWERS LOCK  |       |        |                 |       |       |    |
|  | LEV-20FPFFX   | \$939 | 70     | 5.8             | 15.75 | 19.75 | 28 |
|  | <b>FREESTANDING PEDESTAL - NO TOP</b><br>BOX/BOX/BOX/BOX, ALL DRAWERS LOCK  |       |        |                 |       |       |    |
|  | LEV-20FPUUX   | \$889 | 70     | 5.8             | 15.75 | 19.75 | 28 |
|  | <b>FREESTANDING PEDESTAL - NO TOP</b><br>21" HIGH BOX/FILE, ALL DRAWERS LOCK  |       |        |                 |       |       |    |
|  | LEV-20FPFX-21   | \$760 | 68     | 4.4             | 15.75 | 19.75 | 21 |
|  | <b>FREESTANDING PEDESTAL - NO TOP</b><br>21" HIGH BOX/BOX/BOX, ALL DRAWERS LOCK   |       |        |                 |       |       |    |
|  | LEV-20FPUX-21   | \$827 | 68     | 4.4             | 15.75 | 19.75 | 21 |
|  | <b>FREESTANDING PEDESTAL - NO TOP W/STORAGE RISER</b><br>28" HIGH BOX/FILE, ALL DRAWERS LOCK  |       |        |                 |       |       |    |
|  | LEV-20FPFX-SR28   | \$818 | 106.4  | 5.8             | 15.75 | 19.75 | 28 |
|  | <ul style="list-style-type: none"> <li>• 21" PEDESTAL BOX HEIGHT</li> </ul>   |       |        |                 |       |       |    |
|  | <b>FREESTANDING PEDESTAL - NO TOP W/ STORAGE RISER</b><br>28" HIGH BOX/BOX/BOX, ALL DRAWERS LOCK  |       |        |                 |       |       |    |
|  | LEV-20FPUX-SR28   | \$885 | 106.4  | 5.8             | 15.75 | 19.75 | 28 |
|  | <ul style="list-style-type: none"> <li>• 21" PEDESTAL BOX HEIGHT</li> </ul>   |       |        |                 |       |       |    |

| MODEL | LIST | WEIGHT | CUBE            | W  | D  | H  |
|-------|------|--------|-----------------|----|----|----|
|       |      | LBS    | FT <sup>3</sup> | IN | IN | IN |



**ATTENTION:** ATTENTION: NO-TOP PEDESTALS WILL NEED TO BE INSET FROM METAL LEGS IN ORDER TO CLEAR THE PLATE WIDTH OF LEG. PEDESTALS USED AS WORK SURFACE SUPPORT DO NOT NEED TO BE INSET IF NOT COMBINED WITH A METAL LEG.

**FREESTANDING PEDESTAL - NO TOP**

BOX/BOX/FILE, ALL DRAWERS LOCK.

|                    |              |              |            |              |              |           |
|--------------------|--------------|--------------|------------|--------------|--------------|-----------|
| <b>LEV-24FPUFX</b> | <b>\$940</b> | <b>109.3</b> | <b>6.9</b> | <b>15.75</b> | <b>23.75</b> | <b>28</b> |
|--------------------|--------------|--------------|------------|--------------|--------------|-----------|

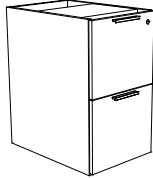

**FREESTANDING PEDESTAL - NO TOP**

FILE/FILE, ALL DRAWERS LOCK.

|                    |                |              |            |              |              |           |
|--------------------|----------------|--------------|------------|--------------|--------------|-----------|
| <b>LEV-24FPFFX</b> | <b>\$1,008</b> | <b>109.3</b> | <b>6.9</b> | <b>15.75</b> | <b>23.75</b> | <b>28</b> |
|--------------------|----------------|--------------|------------|--------------|--------------|-----------|



**FREESTANDING PEDESTAL - NO TOP**

BOX/BOX/BOX/BOX, ALL DRAWERS LOCK.

|                    |                |              |            |              |              |           |
|--------------------|----------------|--------------|------------|--------------|--------------|-----------|
| <b>LEV-24FPUUX</b> | <b>\$1,025</b> | <b>109.3</b> | <b>6.9</b> | <b>15.75</b> | <b>23.75</b> | <b>28</b> |
|--------------------|----------------|--------------|------------|--------------|--------------|-----------|

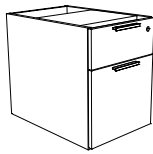

**FREESTANDING PEDESTAL - NO TOP**

21" HIGH BOX/FILE, ALL DRAWERS LOCK.

|                      |              |             |            |              |              |           |
|----------------------|--------------|-------------|------------|--------------|--------------|-----------|
| <b>LEV-24FPFX-21</b> | <b>\$830</b> | <b>80.7</b> | <b>5.2</b> | <b>15.75</b> | <b>23.75</b> | <b>21</b> |
|----------------------|--------------|-------------|------------|--------------|--------------|-----------|



**FREESTANDING PEDESTAL - NO TOP**

21" HIGH BOX/BOX/BOX, ALL DRAWERS LOCK.

|                      |              |             |            |              |              |           |
|----------------------|--------------|-------------|------------|--------------|--------------|-----------|
| <b>LEV-24FPUX-21</b> | <b>\$896</b> | <b>80.7</b> | <b>5.2</b> | <b>15.75</b> | <b>23.75</b> | <b>21</b> |
|----------------------|--------------|-------------|------------|--------------|--------------|-----------|

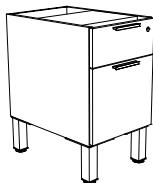

**FREESTANDING PEDESTAL - NO TOP W/ STORAGE RISER**

28" HIGH BOX/FILE, ALL DRAWERS LOCK.

|                        |              |             |            |              |              |           |
|------------------------|--------------|-------------|------------|--------------|--------------|-----------|
| <b>LEV-24FPFX-SR28</b> | <b>\$888</b> | <b>94.9</b> | <b>6.9</b> | <b>15.75</b> | <b>23.75</b> | <b>28</b> |
|------------------------|--------------|-------------|------------|--------------|--------------|-----------|

- 21" PEDESTAL BOX HEIGHT

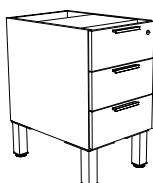







**FREESTANDING PEDESTAL - NO TOP W/ STORAGE RISER**



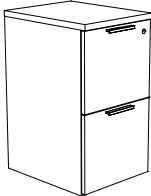

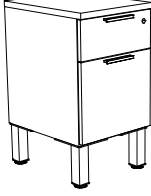

28" HIGH BOX/BOX/BOX, ALL DRAWERS LOCK.

|                        |              |             |            |              |              |           |
|------------------------|--------------|-------------|------------|--------------|--------------|-----------|
| <b>LEV-24FPUX-SR28</b> | <b>\$954</b> | <b>94.9</b> | <b>6.9</b> | <b>15.75</b> | <b>23.75</b> | <b>28</b> |
|------------------------|--------------|-------------|------------|--------------|--------------|-----------|

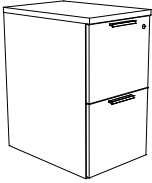
- 21" PEDESTAL BOX HEIGHT

**LEVELS SERIES**  
**20" DEEP FREESTANDING PEDESTALS**

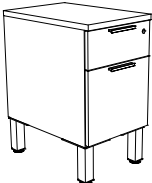
|   | MODEL  | LIST           | WEIGHT       | CUBE            | W            | D            | H         |
|---|--|----------------|--------------|-----------------|--------------|--------------|-----------|
|   |  |                | LBS          | FT <sup>3</sup> | IN           | IN           | IN        |
|    | <b>FREESTANDING PEDESTAL - W/ TOP</b><br>BOX/BOX/FILE, ALL DRAWERS LOCK                              |                |              |                 |              |              |           |
|   | <b>LEV-20FPUF</b>  | <b>\$1,028</b> | <b>101.2</b> | <b>6.1</b>      | <b>15.75</b> | <b>19.75</b> | <b>29</b> |
|    | <b>FREESTANDING PEDESTAL - W/ TOP</b><br>FILE/FILE, ALL DRAWERS LOCK                                 |                |              |                 |              |              |           |
|   | <b>LEV-20FPFF</b>  | <b>\$1,095</b> | <b>101.2</b> | <b>6.1</b>      | <b>15.75</b> | <b>19.75</b> | <b>29</b> |
|    | <b>FREESTANDING PEDESTAL - W/ TOP</b><br>BOX/BOX/BOX/BOX, ALL DRAWERS LOCK.                          |                |              |                 |              |              |           |
|   | <b>LEV-20FPUU</b>  | <b>\$1,113</b> | <b>101.2</b> | <b>6.1</b>      | <b>15.75</b> | <b>19.75</b> | <b>29</b> |
|  | <b>FREESTANDING PEDESTAL - W/ TOP</b><br>22" HIGH BOX/FILE, ALL DRAWERS LOCK.                        |                |              |                 |              |              |           |
|   | <b>LEV-20FPF-22</b>  | <b>\$916</b>   | <b>75.5</b>  | <b>4.6</b>      | <b>15.75</b> | <b>19.75</b> | <b>22</b> |
|  | <b>FREESTANDING PEDESTAL - W/ TOP</b><br>22" HIGH BOX/BOX/BOX, ALL DRAWERS LOCK.                     |                |              |                 |              |              |           |
|   | <b>LEV-20FPU-22</b>  | <b>\$983</b>   | <b>75.5</b>  | <b>4.6</b>      | <b>15.75</b> | <b>19.75</b> | <b>22</b> |
|  | <b>FREESTANDING PEDESTAL - W/ TOP &amp; STORAGE RISER</b><br>29" HIGH BOX/FILE, ALL DRAWERS LOCK.    |                |              |                 |              |              |           |
|   | <b>LEV-20FPF-SR29</b>  | <b>\$974</b>   | <b>89.8</b>  | <b>6.1</b>      | <b>15.75</b> | <b>19.75</b> | <b>29</b> |
|   | <ul style="list-style-type: none"> <li>• 22" PEDESTAL BOX HEIGHT</li> </ul>                          |                |              |                 |              |              |           |
|  | <b>FREESTANDING PEDESTAL - W/ TOP &amp; STORAGE RISER</b><br>29" HIGH BOX/BOX/BOX, ALL DRAWERS LOCK. |                |              |                 |              |              |           |
|   | <b>LEV-20FPU-SR29</b>  | <b>\$1,041</b> | <b>89.8</b>  | <b>6.1</b>      | <b>15.75</b> | <b>19.75</b> | <b>29</b> |
|   | <ul style="list-style-type: none"> <li>• 22" PEDESTAL BOX HEIGHT</li> </ul>                          |                |              |                 |              |              |           |

|   | MODEL  | LIST           | WEIGHT | CUBE            | W     | D     | H  |
|---|--|----------------|--------|-----------------|-------|-------|----|
|   |  |                | LBS    | FT <sup>3</sup> | IN    | IN    | IN |
|    | <b>FREESTANDING PEDESTAL - W/ TOP</b><br>BOX/BOX/FILE, ALL DRAWERS LOCK.                             |                |        |                 |       |       |    |
|   | <b>LEV-24FPUF</b>  | <b>\$1,096</b> | 119.2  | 7.2             | 15.75 | 23.75 | 29 |
|    | <b>FREESTANDING PEDESTAL - W/ TOP</b><br>FILE/FILE, ALL DRAWERS LOCK.                                |                |        |                 |       |       |    |
|   | <b>LEV-24FPFF</b>  | <b>\$1,133</b> | 119.2  | 7.2             | 15.75 | 23.75 | 29 |
|    | <b>FREESTANDING PEDESTAL - W/ TOP</b><br>BOX/BOX/BOX/BOX, ALL DRAWERS LOCK.                          |                |        |                 |       |       |    |
|   | <b>LEV-24FPUU</b>  | <b>\$1,150</b> | 119.2  | 7.2             | 15.75 | 23.75 | 29 |
|   | <b>FREESTANDING PEDESTAL - W/ TOP</b><br>22" HIGH BOX/FILE, ALL DRAWERS LOCK.                        |                |        |                 |       |       |    |
|   | <b>LEV-24FPF-22</b>  | <b>\$985</b>   | 89     | 5.5             | 15.75 | 23.75 | 22 |
|  | <b>FREESTANDING PEDESTAL - W/ TOP</b><br>22" HIGH BOX/BOX/BOX, ALL DRAWERS LOCK.                     |                |        |                 |       |       |    |
|   | <b>LEV-24FPU-22</b>  | <b>\$1,053</b> | 89     | 5.5             | 15.75 | 23.75 | 22 |
|  | <b>FREESTANDING PEDESTAL - W/ TOP &amp; STORAGE RISER</b><br>29" HIGH BOX/FILE, ALL DRAWERS LOCK.    |                |        |                 |       |       |    |
|   | <b>LEV-24FPF-SR29</b>  | <b>\$1,043</b> | 103.2  | 7.2             | 15.75 | 23.75 | 29 |
|   | <ul style="list-style-type: none"> <li>• 22" PEDESTAL BOX HEIGHT</li> </ul>                          |                |        |                 |       |       |    |
|  | <b>FREESTANDING PEDESTAL - W/ TOP &amp; STORAGE RISER</b><br>29" HIGH BOX/BOX/BOX, ALL DRAWERS LOCK. |                |        |                 |       |       |    |
|   | <b>LEV-24FPU-SR29</b>  | <b>\$1,111</b> | 103.2  | 7.2             | 15.75 | 23.75 | 29 |
|   | <ul style="list-style-type: none"> <li>• 22" PEDESTAL BOX HEIGHT</li> </ul>                          |                |        |                 |       |       |    |

**LEVELS SERIES**  
**29" HIGH CREDENZA CABINETS**

| MODEL | LIST     | *AGD | WEIGHT | CUBE            | W  | D  | H  |
|-------|----------|------|--------|-----------------|----|----|----|
|       | UPCHARGE |      | LBS    | FT <sup>3</sup> | IN | IN | IN |

**OPTIONAL AGD (ALUMINIUM GLAZED DOORS) DOORS**

- AGD DOORS INCLUDE SILVER FINISH BAR HANDLES
- THE PRICE SHOWN FOR AGD DOORS IS AN UPCHARGE THAT MUST BE ADDED TO THE BASE PRICE OF THE UNIT IT GOES ON

AGD FINISHES CLEAR (CL), FROSTED (FR) OR BRONZE (BR)

**CABINET CREDENZA**

20" DEEP 4 CABINET DOORS W/ CENTER DIVIDER & 1 ADJUSTABLE SHELF EACH SIDE

|            |                |                |     |    |       |       |    |
|------------|----------------|----------------|-----|----|-------|-------|----|
| LEV-C2060C | <b>\$1,834</b> | <i>\$1,116</i> | 240 | 26 | 59.25 | 19.75 | 29 |
| LEV-C2072C | <b>\$1,939</b> | <i>\$1,143</i> | 255 | 29 | 71    | 19.75 | 29 |

24" DEEP 4 CABINET DOORS W/ CENTER DIVIDER & 1 ADJUSTABLE SHELF EACH SIDE

|            |                |                |     |    |       |       |    |
|------------|----------------|----------------|-----|----|-------|-------|----|
| LEV-C2460C | <b>\$1,971</b> | <i>\$1,116</i> | 275 | 33 | 59.25 | 23.75 | 29 |
| LEV-C2472C | <b>\$2,094</b> | <i>\$1,143</i> | 295 | 36 | 71    | 22.75 | 29 |

- CABINET DOORS LOCK

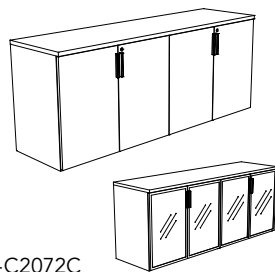

LEV-C2072C  
 LEV-C2072C-AGD

**CABINET/LATERAL FILE CREDENZA**

20" DEEP 2 DOOR CABINET W/ ADJUSTABLE SHELF & 2 DRAWER LATERAL FILES

|             |                |              |     |    |       |       |    |
|-------------|----------------|--------------|-----|----|-------|-------|----|
| LEV-C2060LF | <b>\$1,920</b> | <i>\$558</i> | 230 | 25 | 59.25 | 19.75 | 29 |
| LEV-C2072LF | <b>\$2,229</b> | <i>\$572</i> | 240 | 30 | 71    | 19.75 | 29 |

24" DEEP 2 DOOR CABINET W/ ADJUSTABLE SHELF & 2 DRAWER LATERAL FILES

|             |                |              |     |    |       |       |    |
|-------------|----------------|--------------|-----|----|-------|-------|----|
| LEV-C2460LF | <b>\$2,082</b> | <i>\$558</i> | 247 | 30 | 59.25 | 23.75 | 29 |
| LEV-C2472LF | <b>\$2,386</b> | <i>\$572</i> | 257 | 35 | 71    | 23.75 | 29 |

- CABINET DOORS & LATERAL FILE DRAWERS LOCK

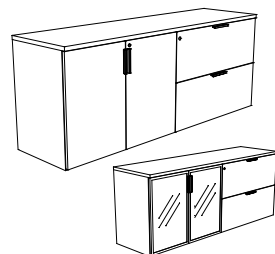

LEV-C2072LF  
 LEV-C2072LF-AGD

**LATERAL FILE/CABINET CREDENZA**

20" DEEP 2 DRAWER LATERAL FILES & 2 DOOR CABINET W/ ADJUSTABLE SHELF

|             |                |              |     |    |       |       |    |
|-------------|----------------|--------------|-----|----|-------|-------|----|
| LEV-LF2060C | <b>\$1,920</b> | <i>\$558</i> | 230 | 25 | 59.25 | 19.75 | 29 |
| LEV-LF2072C | <b>\$2,229</b> | <i>\$572</i> | 240 | 30 | 71    | 19.75 | 29 |

24" DEEP 2 DRAWER LATERAL FILES & 2 DOOR CABINET W/ ADJUSTABLE SHELF

|             |                |              |     |    |       |       |    |
|-------------|----------------|--------------|-----|----|-------|-------|----|
| LEV-LF2460C | <b>\$2,082</b> | <i>\$558</i> | 247 | 30 | 59.25 | 23.75 | 29 |
| LEV-LF2472C | <b>\$2,386</b> | <i>\$572</i> | 257 | 35 | 71    | 23.75 | 29 |

- LATERAL FILE DRAWERS & CABINET DOORS LOCK

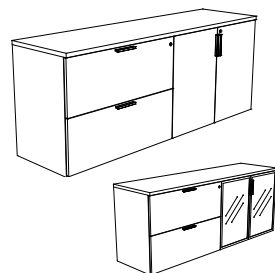

LEV-LF2072C  
 LEV-LF2072C-AGD

**CABINET/BOX/BOX/WIDE DRAWER/LATERAL FILE CREDENZA**

20" DEEP 2 DOOR CABINET W/ ADJUSTABLE SHELF & WIDE DRAWER/ LATERAL FILE

|                 |                |              |     |    |       |       |    |
|-----------------|----------------|--------------|-----|----|-------|-------|----|
| LEV-C2060BBWDLF | <b>\$2,177</b> | <i>\$558</i> | 255 | 25 | 59.25 | 19.75 | 29 |
| LEV-C2072BBWDLF | <b>\$2,407</b> | <i>\$572</i> | 275 | 30 | 71    | 19.75 | 29 |

24" DEEP 2 DOOR CABINET W/ ADJUSTABLE SHELF & BOX/BOX/ WIDE DRAWER/ LATERAL FILE

|                 |                |              |     |    |       |       |    |
|-----------------|----------------|--------------|-----|----|-------|-------|----|
| LEV-C2460BBWDLF | <b>\$2,244</b> | <i>\$558</i> | 275 | 30 | 59.25 | 23.75 | 29 |
| LEV-C2472BBWDLF | <b>\$2,471</b> | <i>\$572</i> | 295 | 36 | 71    | 23.75 | 29 |

- LOCKING CABINET DOORS, WIDE DRAWER & LATERAL FILE DRAWERS LOCK
- FOR LOCKING BOX DRAWERS, SEE OPTIONAL LOCK [LEV-6](#)

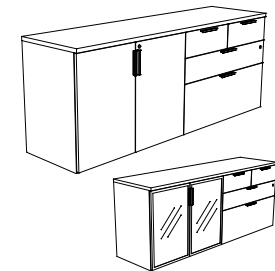

LEV-C2072BBWDLF  
 LEV-C2072BBWDLF-AGD

| MODEL | LIST | *AGD     | WEIGHT | CUBE            | W  | D  | H  |
|-------|------|----------|--------|-----------------|----|----|----|
|       |      | UPCHARGE | LBS    | FT <sup>3</sup> | IN | IN | IN |

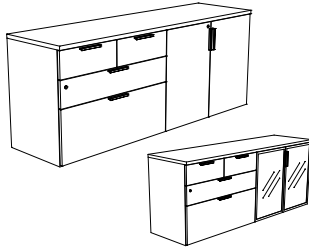

LEV-BBWDLF2072C  
LEV-BBWDLF2072C-AGD

**BOX/BOX/WIDE DRAWER/LATERAL FILE CABINET CREDENZA**

20" DEEP BOX/BOX/ WIDE DRAWER/ LATERAL FILE & 2 DOOR CABINET W/ ADJUSTABLE SHELF

|                 |                |              |     |    |       |       |    |
|-----------------|----------------|--------------|-----|----|-------|-------|----|
| LEV-BBWDLF2060C | <b>\$2,177</b> | <i>\$558</i> | 255 | 25 | 59.25 | 19.75 | 29 |
| LEV-BBWDLF2072C | <b>\$2,407</b> | <i>\$572</i> | 275 | 30 | 71    | 19.75 | 29 |

24" DEEP BOX/BOX/ WIDE DRAWER/ LATERAL FILE & 2 DOOR CABINET W/ ADJUSTABLE SHELF

|                 |                |              |     |    |       |       |    |
|-----------------|----------------|--------------|-----|----|-------|-------|----|
| LEV-BBWDLF2460C | <b>\$2,244</b> | <i>\$558</i> | 275 | 30 | 59.25 | 23.75 | 29 |
| LEV-BBWDLF2472C | <b>\$2,471</b> | <i>\$572</i> | 295 | 36 | 71    | 23.75 | 29 |

- LOCKING CABINET DOORS, WIDE DRAWER & LATERAL FILE DRAWERS LOCK

**29" HIGH CREDENZA CABINETS WITH STORAGE RISERS**

**\*OPTIONAL AGD (ALUMINIUM GLAZED DOORS) DOORS**

- AGD DOORS INCLUDE SILVER FINISH BAR HANDLES
- THE PRICE SHOWN FOR AGD DOORS IS AN UPCHARGE THAT MUST BE ADDED TO THE BASE PRICE OF THE UNIT IT GOES ON

AGD FINISHES: CLEAR (CL), FROSTED (FR) OR BRONZE (BR)

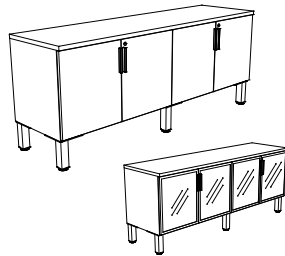

LEV-C2072C-SR29  
LEV-C2072C-SR29-AGD

**CABINET CREDENZA W/STORAGE RISER**

20" DEEP 4 CABINET DOORS W/ CENTER DIVIDER & 1 ADJUSTABLE SHELF EACH SIDE

|                 |                |                |     |    |       |       |    |
|-----------------|----------------|----------------|-----|----|-------|-------|----|
| LEV-C2060C-SR29 | <b>\$1,849</b> | <i>\$1,062</i> | 240 | 26 | 59.25 | 19.75 | 29 |
| LEV-C2072C-SR29 | <b>\$1,967</b> | <i>\$1,090</i> | 255 | 29 | 71    | 19.75 | 29 |

24" DEEP 4 CABINET DOORS W/ CENTER DIVIDER & 1 ADJUSTABLE SHELF EACH SIDE

|                 |                |                |     |    |       |       |    |
|-----------------|----------------|----------------|-----|----|-------|-------|----|
| LEV-C2460C-SR29 | <b>\$1,858</b> | <i>\$1,062</i> | 275 | 33 | 59.25 | 23.75 | 29 |
| LEV-C2472C-SR29 | <b>\$2,120</b> | <i>\$1,090</i> | 295 | 36 | 71    | 23.75 | 29 |

- CABINET DOORS LOCK

**DESK HEIGHT**

20" DEEP OPEN CABINET/CABINET STORAGE W/ 1 ADJUSTABLE SHELF BOTH SIDES

|                  |                |              |     |    |       |       |    |
|------------------|----------------|--------------|-----|----|-------|-------|----|
| LEV-CO2060C-SR29 | <b>\$1,419</b> | <i>\$532</i> | 255 | 25 | 59.25 | 19.75 | 29 |
| LEV-CO2072C-SR29 | <b>\$1,570</b> | <i>\$544</i> | 275 | 30 | 71    | 19.75 | 29 |

24" DEEP OPEN CABINET/CABINET STORAGE W/ 1 ADJUSTABLE SHELF BOTH SIDES

|                  |                |              |     |    |       |       |    |
|------------------|----------------|--------------|-----|----|-------|-------|----|
| LEV-CO2460C-SR29 | <b>\$1,512</b> | <i>\$532</i> | 275 | 30 | 59.25 | 23.75 | 29 |
| LEV-CO2472C-SR29 | <b>\$1,665</b> | <i>\$544</i> | 295 | 36 | 71    | 23.75 | 29 |

- CABINET DOORS LOCK

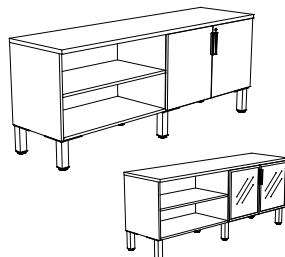

LEV-CO2072C-SR29  
LEV-CO2072C-SR29-AGD

# LEVELS SERIES

## 29" HIGH CREDENZA CABINETS WITH STORAGE RISERS

| MODEL | LIST     | *AGD | WEIGHT | CUBE            | W  | D  | H  |
|-------|----------|------|--------|-----------------|----|----|----|
|       | UPCHARGE |      | LBS    | FT <sup>3</sup> | IN | IN | IN |

### CABINET CREDENZA/OPEN SHELF W/ STORAGE RISER

20" DEEP OPEN CABINET/CABINET STORAGE W/ 1 ADJUSTABLE SHELF BOTH SIDES

|                  |         |       |     |    |       |       |    |
|------------------|---------|-------|-----|----|-------|-------|----|
| LEV-C2060CO-SR29 | \$1,419 | \$532 | 255 | 25 | 59.25 | 19.75 | 29 |
| LEV-C2072CO-SR29 | \$1,570 | \$544 | 275 | 30 | 71    | 19.75 | 29 |

24" DEEP OPEN CABINET/CABINET STORAGE W/ 1 ADJUSTABLE SHELF BOTH SIDES

|                  |         |       |     |    |       |       |    |
|------------------|---------|-------|-----|----|-------|-------|----|
| LEV-C2460CO-SR29 | \$1,512 | \$532 | 275 | 30 | 59.25 | 23.75 | 29 |
| LEV-C2472CO-SR29 | \$1,665 | \$544 | 295 | 36 | 71    | 23.75 | 29 |

- CABINET DOORS LOCK

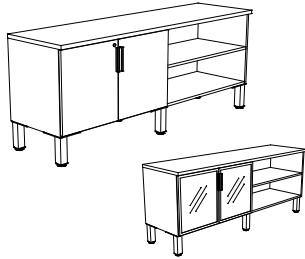

LEV-C2072CO-SR29  
LEV-C2072CO-SR29-AGD

### OPEN SHELF/ WIDE DRAWER/LATERAL FILE CREDENZA W/ STORAGE RISER

20" DEEP OPEN CABINET W/ ADJUSTABLE SHELF & WIDE DRAWER/ LATERAL FILE STORAGE

|                     |         |     |     |    |       |       |    |
|---------------------|---------|-----|-----|----|-------|-------|----|
| LEV-CO2060WDLF-SR29 | \$1,543 | N/A | 275 | 30 | 59.25 | 19.75 | 29 |
| LEV-CO2072WDLF-SR29 | \$1,644 | N/A | 212 | 23 | 71    | 19.75 | 29 |

24" DEEP OPEN CABINET W/ ADJUSTABLE SHELF & WIDE DRAWER/ LATERAL FILE STORAGE

|                     |         |     |     |    |       |       |    |
|---------------------|---------|-----|-----|----|-------|-------|----|
| LEV-CO2460WDLF-SR29 | \$1,638 | N/A | 275 | 30 | 59.25 | 23.75 | 29 |
| LEV-CO2472WDLF-SR29 | \$1,737 | N/A | 227 | 27 | 71    | 23.75 | 29 |

- LOCKING DRAWERS



LEV-CO2072WDLF-SR29

### WIDE DRAWER/LATERAL FILE/OPEN SHELF CREDENZA W/ STORAGE RISER

20" DEEP WIDE DRAWER/ LATERAL FILES STORAGE & OPEN CABINET W/ ADJUSTABLE SHELF

|                     |         |     |     |    |       |       |    |
|---------------------|---------|-----|-----|----|-------|-------|----|
| LEV-WDLF2060CO-SR29 | \$1,543 | N/A | 255 | 25 | 59.25 | 19.75 | 29 |
| LEV-WDLF2072CO-SR29 | \$1,644 | N/A | 212 | 23 | 71    | 19.75 | 29 |

24" DEEP WIDE DRAWER/ LATERAL FILES STORAGE & OPEN CABINET W/ ADJUSTABLE SHELF

|                     |         |     |     |    |       |       |    |
|---------------------|---------|-----|-----|----|-------|-------|----|
| LEV-WDLF2460CO-SR29 | \$1,638 | N/A | 275 | 30 | 59.25 | 23.75 | 29 |
| LEV-WDLF2472CO-SR29 | \$1,737 | N/A | 227 | 27 | 71    | 23.75 | 29 |

- LOCKING DRAWERS



LEV-WDLF2072CO-SR29

### OPEN SHELF/BOX/BOX/LATERAL FILE CREDENZA W/ STORAGE RISER

20" DEEP OPEN CABINET W/ 1 ADJUSTABLE SHELF & BOX/BOX LATERAL FILE STORAGE

|                     |         |     |     |    |       |       |    |
|---------------------|---------|-----|-----|----|-------|-------|----|
| LEV-CO2060BBLF-SR29 | \$1,804 | N/A | 255 | 25 | 59.25 | 19.75 | 29 |
| LEV-CO2072BBLF-SR29 | \$1,960 | N/A | 275 | 30 | 71    | 19.75 | 29 |

### OPEN SHELF/BOX/BOX/LATERAL FILE CREDENZA W/ STORAGE RISER

|                     |         |     |     |    |       |       |    |
|---------------------|---------|-----|-----|----|-------|-------|----|
| LEV-CO2460BBLF-SR29 | \$1,869 | N/A | 275 | 30 | 59.25 | 23.75 | 29 |
| LEV-CO2472BBLF-SR29 | \$2,026 | N/A | 295 | 36 | 71    | 23.75 | 29 |

- LATERAL FILE DRAWER LOCKS
- FOR LOCKING BOX DRAWERS, SEE OPTIONAL LOCK [LEV-6](#)



LEV-CO2072BBLF-SR29



| MODEL | LIST     | *AGD | WEIGHT | CUBE            | W  | D  | H  |
|-------|----------|------|--------|-----------------|----|----|----|
|       | UPCHARGE |      | LBS    | FT <sup>3</sup> | IN | IN | IN |



LEV-BBLF2072CO-SR29

**BOX/BOX/WIDE DRAWER/LATERAL FILE CABINET CREDENZA W/ STORAGE RISER**

20" DEEP BOX/BOX LATERAL FILE STORAGE & OPEN CABINET W/ 1 ADJUSTABLE SHELF

|                            |                |            |            |           |              |              |           |
|----------------------------|----------------|------------|------------|-----------|--------------|--------------|-----------|
| <b>LEV-BBLF2060CO-SR29</b> | <b>\$1,804</b> | <i>N/A</i> | <b>255</b> | <b>25</b> | <b>59.25</b> | <b>19.75</b> | <b>29</b> |
| <b>LEV-BBLF2072CO-SR29</b> | <b>\$1,960</b> | <i>N/A</i> | <b>275</b> | <b>30</b> | <b>71</b>    | <b>19.75</b> | <b>29</b> |

24" DEEP BOX/BOX LATERAL FILE STORAGE & OPEN CABINET W/ 1 ADJUSTABLE SHELF

|                            |                |            |            |           |              |              |           |
|----------------------------|----------------|------------|------------|-----------|--------------|--------------|-----------|
| <b>LEV-BBLF2460CO-SR29</b> | <b>\$1,869</b> | <i>N/A</i> | <b>275</b> | <b>30</b> | <b>59.25</b> | <b>23.75</b> | <b>29</b> |
| <b>LEV-BBLF2472CO-SR29</b> | <b>\$2,026</b> | <i>N/A</i> | <b>295</b> | <b>36</b> | <b>71</b>    | <b>23.75</b> | <b>29</b> |

- LATERAL FILE DRAWER LOCKS

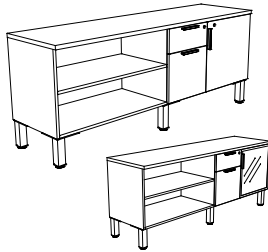

LEV-CO2072FC-SR29  
LEV-CO2072FC-SR29-AGD

**OPEN SHELF/BOX/FILE/CABINET CREDENZA W/ STORAGE RISER**

20" DEEP OPEN CABINET W/ ADJUSTABLE SHELF & BOX/FILE & 1 DOOR CABINET STORAGE WITH ADJUSTABLE SHELF

|                          |                |              |            |           |              |              |           |
|--------------------------|----------------|--------------|------------|-----------|--------------|--------------|-----------|
| <b>LEV-CO2060FC-SR29</b> | <b>\$1,758</b> | <i>\$262</i> | <b>255</b> | <b>25</b> | <b>59.25</b> | <b>19.75</b> | <b>29</b> |
| <b>LEV-CO2072FC-SR29</b> | <b>\$1,914</b> | <i>\$276</i> | <b>275</b> | <b>30</b> | <b>71</b>    | <b>19.75</b> | <b>29</b> |

24" DEEP OPEN CABINET W/ ADJUSTABLE SHELF & BOX/FILE & 1 DOOR CABINET STORAGE WITH ADJUSTABLE SHELF

|                          |                |              |            |           |              |              |           |
|--------------------------|----------------|--------------|------------|-----------|--------------|--------------|-----------|
| <b>LEV-CO2460FC-SR29</b> | <b>\$1,822</b> | <i>\$262</i> | <b>275</b> | <b>30</b> | <b>59.25</b> | <b>23.75</b> | <b>29</b> |
| <b>LEV-CO2472FC-SR29</b> | <b>\$1,979</b> | <i>\$276</i> | <b>295</b> | <b>36</b> | <b>71</b>    | <b>23.75</b> | <b>29</b> |

- LOCKING DRAWERS & DOOR

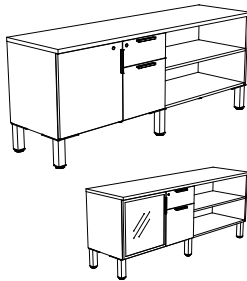

LEV-CF2072CO-SR29  
LEV-CF2072CO-SR29-AGD

**CABINET/BOX/FILE, OPEN SHELF CREDENZA W/ STORAGE RISER**

20" DEEP 1 DOOR/BOX/FILE CABINET W/ ADJUSTABLE SHELF & OPEN CABINET WITH ADJUSTABLE SHELF

|                          |                |              |            |           |              |              |           |
|--------------------------|----------------|--------------|------------|-----------|--------------|--------------|-----------|
| <b>LEV-CF2060CO-SR29</b> | <b>\$1,758</b> | <i>\$262</i> | <b>255</b> | <b>25</b> | <b>59.25</b> | <b>19.75</b> | <b>29</b> |
| <b>LEV-CF2072CO-SR29</b> | <b>\$1,914</b> | <i>\$276</i> | <b>275</b> | <b>23</b> | <b>71</b>    | <b>19.75</b> | <b>29</b> |

24" DEEP 1 DOOR/BOX/FILE CABINET W/ ADJUSTABLE SHELF & OPEN CABINET WITH ADJUSTABLE SHELF

|                          |                |              |            |           |              |              |           |
|--------------------------|----------------|--------------|------------|-----------|--------------|--------------|-----------|
| <b>LEV-CF2460CO-SR29</b> | <b>\$1,822</b> | <i>\$262</i> | <b>275</b> | <b>30</b> | <b>59.25</b> | <b>23.75</b> | <b>29</b> |
| <b>LEV-CF2472CO-SR29</b> | <b>\$1,979</b> | <i>\$276</i> | <b>295</b> | <b>36</b> | <b>71</b>    | <b>23.75</b> | <b>29</b> |

**OPEN SHELF CREDENZA & SLIDING DOOR W/ STORAGE RISER**

20" DEEP OPEN CABINETS W/ ADJUSTABLE SHELF & SLIDING DOOR

|                           |                |            |            |           |              |              |           |
|---------------------------|----------------|------------|------------|-----------|--------------|--------------|-----------|
| <b>LEV-CO2060SDC-SR29</b> | <b>\$1,498</b> | <i>N/A</i> | <b>255</b> | <b>25</b> | <b>59.25</b> | <b>19.75</b> | <b>29</b> |
| <b>LEV-CO2072SDC-SR29</b> | <b>\$1,654</b> | <i>N/A</i> | <b>275</b> | <b>30</b> | <b>71</b>    | <b>19.75</b> | <b>29</b> |

24" DEEP OPEN CABINETS W/ ADJUSTABLE SHELF & SLIDING DOOR

|                           |                |            |            |           |              |              |           |
|---------------------------|----------------|------------|------------|-----------|--------------|--------------|-----------|
| <b>LEV-CO2460SDC-SR29</b> | <b>\$1,563</b> | <i>N/A</i> | <b>275</b> | <b>30</b> | <b>59.25</b> | <b>23.75</b> | <b>29</b> |
| <b>LEV-CO2472SDC-SR29</b> | <b>\$1,719</b> | <i>N/A</i> | <b>295</b> | <b>36</b> | <b>71</b>    | <b>23.75</b> | <b>29</b> |

- CENTER LOCKING SLIDING DOOR
- HANDLES ON THE LEFT



LEV-CO2072SDC-SR29

**LEVELS SERIES**  
**22" HIGH CREDENZA CABINETS**

| MODEL | LIST     | *AGD | WEIGHT | CUBE            | W  | D  | H  |
|-------|----------|------|--------|-----------------|----|----|----|
|       | UPCHARGE |      | LBS    | FT <sup>3</sup> | IN | IN | IN |

**\*OPTIONAL AGD (ALUMINIUM GLAZED DOORS) DOORS**

- AGD DOORS INCLUDE SILVER FINISH BAR HANDLES
- THE PRICE SHOWN FOR AGD DOORS IS AN UPCHARGE THAT MUST BE ADDED TO THE BASE PRICE OF THE UNIT IT GOES ON

AGD FINISHES: CLEAR (CL), FROSTED (FR) OR BRONZE (BR)

**22" HIGH CABINET CREDENZA**

20" DEEP 4 CABINET DOORS W/ CENTER DIVIDER & 1 ADJUSTABLE SHELF EACH SIDE

|               |                |                |     |    |       |       |    |
|---------------|----------------|----------------|-----|----|-------|-------|----|
| LEV-C2060C-22 | <b>\$1,762</b> | <i>\$1,062</i> | 240 | 19 | 59.25 | 19.75 | 22 |
| LEV-C2072C-22 | <b>\$1,880</b> | <i>\$1,090</i> | 255 | 23 | 71    | 19.75 | 22 |

24" DEEP 4 CABINET DOORS W/ CENTER DIVIDER & 1 ADJUSTABLE SHELF EACH SIDE

|               |                |                |     |    |       |       |    |
|---------------|----------------|----------------|-----|----|-------|-------|----|
| LEV-C2460C-22 | <b>\$1,771</b> | <i>\$1,062</i> | 240 | 23 | 59.25 | 23.75 | 22 |
| LEV-C2472C-22 | <b>\$2,033</b> | <i>\$1,090</i> | 255 | 27 | 71    | 23.75 | 22 |

- CABINET DOORS LOCK

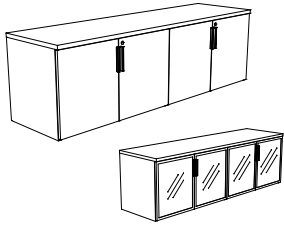

LEV-C2072C-22  
 LEV-C2072C-22-AGD

**22" HIGH OPEN SHELF/CABINET CREDENZA**

24" DEEP OPEN CABINET W/ ADJUSTABLE SHELF & 2 DOOR CABINET WITH ADJUSTABLE SHELF

|                |                |              |     |    |       |       |    |
|----------------|----------------|--------------|-----|----|-------|-------|----|
| LEV-CO2060C-22 | <b>\$1,332</b> | <i>\$532</i> | 178 | 19 | 59.25 | 19.75 | 22 |
| LEV-CO2072C-22 | <b>\$1,483</b> | <i>\$544</i> | 195 | 23 | 71    | 19.75 | 22 |

24" DEEP OPEN CABINET W/ ADJUSTABLE SHELF & 2 DOOR CABINET WITH ADJUSTABLE SHELF

|                |                |              |     |    |       |       |    |
|----------------|----------------|--------------|-----|----|-------|-------|----|
| LEV-CO2460C-22 | <b>\$1,425</b> | <i>\$532</i> | 187 | 23 | 59.25 | 23.75 | 22 |
| LEV-CO2472C-22 | <b>\$1,578</b> | <i>\$544</i> | 210 | 27 | 71    | 23.75 | 22 |

- CABINET DOORS LOCK

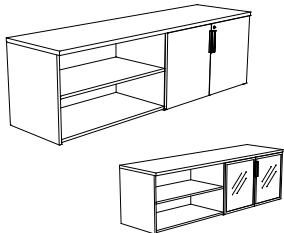

LEV-CO2072C-22  
 LEV-CO2072C-22-AGD

**22" HIGH CABINET CREDENZA/OPEN SHELF**

20" DEEP 2 DOOR CABINET W/ ADJUSTABLE SHELF & OPEN CABINET WITH ADJUSTABLE SHELF

|                |                |              |     |    |       |       |    |
|----------------|----------------|--------------|-----|----|-------|-------|----|
| LEV-C2060CO-22 | <b>\$1,332</b> | <i>\$532</i> | 178 | 19 | 59.25 | 19.75 | 22 |
| LEV-C2072CO-22 | <b>\$1,483</b> | <i>\$544</i> | 195 | 23 | 71    | 19.75 | 22 |

24" DEEP 2 DOOR CABINET W/ ADJUSTABLE SHELF & OPEN CABINET WITH ADJUSTABLE SHELF

|                |                |              |     |    |       |       |    |
|----------------|----------------|--------------|-----|----|-------|-------|----|
| LEV-C2460CO-22 | <b>\$1,425</b> | <i>\$532</i> | 187 | 23 | 59.25 | 23.75 | 22 |
| LEV-C2472CO-22 | <b>\$1,578</b> | <i>\$544</i> | 210 | 27 | 71    | 23.75 | 22 |

- CABINET DOORS LOCK

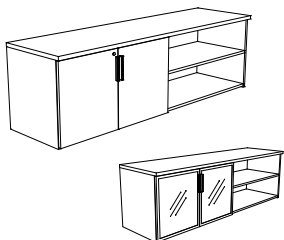

LEV-C2072CO-22  
 LEV-C2072CO-22-AGD

| MODEL | LIST     | *AGD | WEIGHT | CUBE            | W  | D  | H  |
|-------|----------|------|--------|-----------------|----|----|----|
|       | UPCHARGE |      | LBS    | FT <sup>3</sup> | IN | IN | IN |

**22" HIGH OPEN SHELF/WIDE DRAWER/LATERAL FILE CREDENZA**

20" DEEP OPEN CABINET W/ ADJUSTABLE SHELF & WIDE DRAWER/ LATERAL FILE

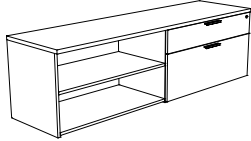

LEV-CO2072C-22

|                   |         |     |     |    |       |       |    |
|-------------------|---------|-----|-----|----|-------|-------|----|
| LEV-CO2060WDLF-22 | \$1,456 | N/A | 191 | 19 | 59.25 | 19.75 | 22 |
| LEV-CO2072WDLF-22 | \$1,557 | N/A | 207 | 23 | 71    | 19.75 | 22 |

24" DEEP OPEN CABINET W/ ADJUSTABLE SHELF & WIDE DRAWER/ LATERAL FILE

|                   |         |     |     |    |       |       |    |
|-------------------|---------|-----|-----|----|-------|-------|----|
| LEV-CO2460WDLF-22 | \$1,551 | N/A | 199 | 23 | 59.25 | 23.75 | 22 |
| LEV-CO2472WDLF-22 | \$1,650 | N/A | 222 | 27 | 71    | 23.75 | 22 |

**22" HIGH WIDE DRAWER/LATERAL FILE/OPEN SHELF CREDENZA**

20" DEEP W/ 1 ADJUSTABLE SHELF. ALL DRAWERS LOCK.



LEV-C2072CO-22

|                   |         |     |     |    |       |       |    |
|-------------------|---------|-----|-----|----|-------|-------|----|
| LEV-WDLF2060CO-22 | \$1,456 | N/A | 191 | 19 | 59.25 | 19.75 | 22 |
| LEV-WDLF2072CO-22 | \$1,557 | N/A | 207 | 23 | 71    | 19.75 | 22 |

24" DEEP W/ 1 ADJUSTABLE SHELF. ALL DRAWERS LOCK.

|                   |         |     |     |    |       |       |    |
|-------------------|---------|-----|-----|----|-------|-------|----|
| LEV-WDLF2460CO-22 | \$1,551 | N/A | 199 | 23 | 59.25 | 23.75 | 22 |
| LEV-WDLF2472CO-22 | \$1,650 | N/A | 222 | 27 | 71    | 23.75 | 22 |

- WIDE DRAWER & LATERAL FILE DRAWERS LOCK

**22" HIGH OPEN SHELF/BOX/BOX/LATERAL FILE CREDENZA**

20" DEEP OPEN CABINET W/ ADJUSTABLE SHELF & BOX/BOX LATERAL FILE



LEV-CO2072BBLF-22

|                   |         |     |     |    |       |       |    |
|-------------------|---------|-----|-----|----|-------|-------|----|
| LEV-CO2060BBLF-22 | \$1,717 | N/A | 196 | 19 | 59.25 | 19.75 | 22 |
| LEV-CO2072BBLF-22 | \$1,873 | N/A | 212 | 23 | 71    | 19.75 | 22 |

24" DEEP OPEN CABINET W/ ADJUSTABLE SHELF & BOX/BOX LATERAL FILE

|                   |         |     |     |    |       |       |    |
|-------------------|---------|-----|-----|----|-------|-------|----|
| LEV-CO2460BBLF-22 | \$1,782 | N/A | 204 | 23 | 59.25 | 23.75 | 22 |
| LEV-CO2472BBLF-22 | \$1,939 | N/A | 227 | 27 | 71    | 23.75 | 22 |

- LATERAL FILE DRAWERS LOCKS
- FOR LOCKING BOX DRAWERS, SEE OPTIONAL LOCK [LEV-6](#)

**22" HIGH BOX/BOX/WIDE DRAWER/LATERAL FILE OPEN CABINET CREDENZA**

20" DEEP BOX/BOX LATERAL FILE STORAGE & OPEN CABINET W/ ADJUSTABLE SHELF

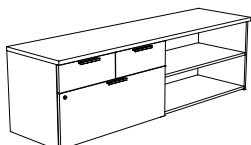

LEV-BBLF2072CO-22

|                   |         |     |     |    |       |       |    |
|-------------------|---------|-----|-----|----|-------|-------|----|
| LEV-BBLF2060CO-22 | \$1,717 | N/A | 196 | 19 | 59.25 | 19.75 | 22 |
| LEV-BBLF2072CO-22 | \$1,873 | N/A | 212 | 23 | 71    | 19.75 | 22 |

24" DEEP BOX/BOX LATERAL FILE STORAGE & OPEN CABINET W/ ADJUSTABLE SHELF

|                   |         |     |     |    |       |       |    |
|-------------------|---------|-----|-----|----|-------|-------|----|
| LEV-BBLF2460CO-22 | \$1,782 | N/A | 204 | 23 | 59.25 | 23.75 | 22 |
| LEV-BBLF2472CO-22 | \$1,939 | N/A | 227 | 27 | 71    | 23.75 | 22 |

- LATERAL FILE DRAWERS LOCKS
- FOR LOCKING BOX DRAWERS, SEE OPTIONAL LOCK [LEV-6](#)

# LEVELS SERIES

## 22" HIGH CREDENZA CABINETS

| MODEL | LIST     | *AGD | WEIGHT | CUBE            | W  | D  | H  |
|-------|----------|------|--------|-----------------|----|----|----|
|       | UPCHARGE |      | LBS    | FT <sup>3</sup> | IN | IN | IN |

### 22" HIGH OPEN SHELF/BOX/FILE/CABINET CREDENZA

20" DEEP OPEN CABINET W/ ADJUSTABLE SHELF & BOX/FILE & 1 DOOR CABINET STORAGE WITH ADJUSTABLE SHELF

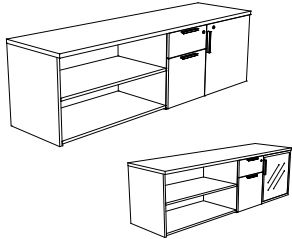

LEV-CO2072FC-22  
LEV-CO2072FC-22-AGD

|                 |                |       |     |    |       |       |    |
|-----------------|----------------|-------|-----|----|-------|-------|----|
| LEV-CO2060FC-22 | <b>\$1,671</b> | \$262 | 187 | 19 | 59.25 | 19.75 | 22 |
| LEV-CO2072FC-22 | <b>\$1,827</b> | \$276 | 203 | 23 | 71    | 19.75 | 22 |

24" DEEP OPEN CABINET W/ ADJUSTABLE SHELF & BOX/FILE & 1 DOOR CABINET STORAGE WITH ADJUSTABLE SHELF

|                 |                |       |     |    |       |       |    |
|-----------------|----------------|-------|-----|----|-------|-------|----|
| LEV-CO2460FC-22 | <b>\$1,735</b> | \$262 | 195 | 23 | 59.25 | 23.75 | 22 |
| LEV-CO2472FC-22 | <b>\$1,892</b> | \$276 | 218 | 27 | 71    | 23.75 | 22 |

### 22" HIGH CABINET/BOX/FILE, OPEN SHELF CREDENZAS

20" DEEP 1 DOOR/BOX/FILE CABINET W/ ADJUSTABLE SHELF & OPEN CABINET WITH ADJUSTABLE SHELF

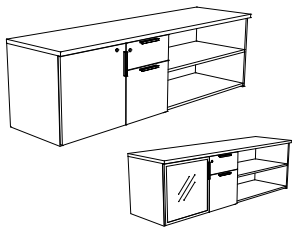

LEV-CF2072CO-22  
LEV-CF2072CO-22-AGD

|                 |                |       |     |    |       |       |    |
|-----------------|----------------|-------|-----|----|-------|-------|----|
| LEV-CF2060CO-22 | <b>\$1,671</b> | \$262 | 187 | 19 | 59.25 | 19.75 | 22 |
| LEV-CF2072CO-22 | <b>\$1,827</b> | \$276 | 203 | 23 | 71    | 19.75 | 22 |

24" DEEP 1 DOOR/BOX/FILE CABINET W/ ADJUSTABLE SHELF & OPEN CABINET WITH ADJUSTABLE SHELF

|                 |                |       |     |    |       |       |    |
|-----------------|----------------|-------|-----|----|-------|-------|----|
| LEV-CF2460CO-22 | <b>\$1,735</b> | \$262 | 195 | 23 | 59.25 | 23.75 | 22 |
| LEV-CF2472CO-22 | <b>\$1,892</b> | \$276 | 218 | 27 | 71    | 23.75 | 22 |

- LOCKING DRAWERS & DOOR

### 22" HIGH SLIDING DOOR CREDENZAS

20" DEEP OPEN CABINETS W/ ADJUSTABLE SHELF & SLIDING DOOR



LEV-CO2072SDC-22

|                  |                |     |     |    |       |       |    |
|------------------|----------------|-----|-----|----|-------|-------|----|
| LEV-CO2060SDC-22 | <b>\$1,411</b> | N/A | 178 | 19 | 59.25 | 19.75 | 22 |
| LEV-CO2072SDC-22 | <b>\$1,567</b> | N/A | 195 | 23 | 71    | 19.75 | 22 |

N/A24" DEEP OPEN CABINETS W/ ADJUSTABLE SHELF & SLIDING DOOR

|                  |                |     |     |    |       |       |    |
|------------------|----------------|-----|-----|----|-------|-------|----|
| LEV-CO2460SDC-22 | <b>\$1,476</b> | N/A | 187 | 23 | 59.25 | 23.75 | 22 |
| LEV-CO2472SDC-22 | <b>\$1,632</b> | N/A | 210 | 27 | 71    | 23.75 | 22 |

- CENTER LOCKING SLIDING DOOR
- HANDLES ON THE LEFT

### DESK HEIGHT | LOW STORAGE STORAGE SIZING

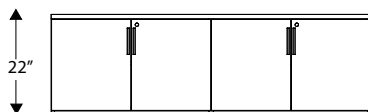

22" HIGH STORAGE - LOW HEIGHT

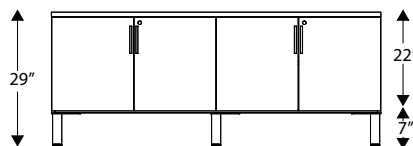

29" HIGH STORAGE WITH STORAGE RISERS - DESK HEIGHT

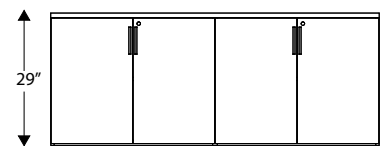

29" HIGH STORAGE - DESK HEIGHT

| MODEL | LIST | WEIGHT | CUBE            | W  | D  | H  |
|-------|------|--------|-----------------|----|----|----|
|       |      | LBS    | FT <sup>3</sup> | IN | IN | IN |

**SEAT CUSHIONS FOR 22" HIGH CREDENZAS**

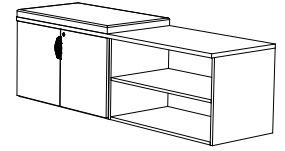

| MODEL        | USE ON            | LIST   |          |               |      |   |       |       |   |
|--------------|-------------------|--------|----------|---------------|------|---|-------|-------|---|
|              |                   | ESCAPE | HEAVENLY | ULTRA LEATHER |      |   |       |       |   |
| LEV-2030CUSH | 20 X 60" CREDENZA | \$457  | \$476    | \$519         | 11   | 2 | 29.75 | 19.75 | 2 |
| LEV-2036CUSH | 20 X 72" CREDENZA | \$457  | \$476    | \$519         | 13.1 | 2 | 35.5  | 19.75 | 2 |
| LEV-2430CUSH | 24 X 60" CREDENZA | \$525  | \$562    | \$569         | 13.3 | 2 | 29.75 | 23.75 | 2 |
| LEV-2436CUSH | 24 X 72" CREDENZA | \$525  | \$562    | \$569         | 15.9 | 2 | 35.5  | 23.75 | 2 |

- ESCAPE** - 100% POLYESTER, JACQUARD WOVEN  
 - 100% POLYESTER, SOLID PLAIN WEAVE  
 ADD '-ESC' TO ITEM #  
 EXAMPLE: WRK-2430CUSH-ESC
- HEAVENLY** - 20% RAYON 80% POLYESTER, SOLID PLAIN WEAVE  
 ADD '-HEA' TO ITEM #  
 EXAMPLE: WRK-2430CUSH-HEA
- ULTRALEATHER** - 100% POLYVINYL CHLORIDE, FAUX LEATHER, ANTI-BACTERIAL  
 ADD '-ULT' TO ITEM #  
 EXAMPLE: WRK-2430CUSH-ULT

**NOTES:** PLEASE REFER TO THE FINISHES & FABRICS TAB ON THE WWW.HEARTWOOD.CA WEBSITE FOR A COMPLETE LISTING OF THE COLOUR CHOICES AVAILABLE IN EACH FABRIC. CONTACT CUSTOMER SERVICE IF TWO SEAT CUSHIONS ARE REQUIRED TO BE SIDE BY SIDE AS SIZING MAY NEED TO BE ADJUSTED.

**LATERAL FILE**

20" DEEP LATERAL FILE

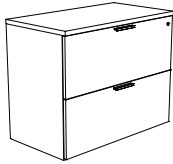

LEV-2036LF

|            |         |     |    |       |       |    |
|------------|---------|-----|----|-------|-------|----|
| LEV-2024LF | \$1,043 | 120 | 13 | 23.75 | 19.75 | 29 |
| LEV-2030LF | \$1,076 | 120 | 13 | 29.5  | 19.75 | 29 |
| LEV-2036LF | \$1,113 | 135 | 15 | 35.5  | 19.75 | 29 |

24" DEEP LATERAL FILE

|            |         |     |    |       |       |    |
|------------|---------|-----|----|-------|-------|----|
| LEV-2424LF | \$1,126 | 130 | 15 | 23.75 | 23.75 | 29 |
| LEV-2430LF | \$1,142 | 130 | 15 | 29.5  | 23.75 | 29 |
| LEV-2436LF | \$1,167 | 145 | 18 | 35.5  | 23.75 | 29 |

- LOCKING DRAWERS

**LATERAL FILE - NO TOP**

20" DEEP LATERAL FILE, NO TOP

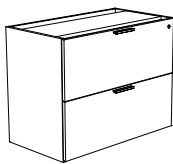

LEV-2036LFX

|             |         |    |    |       |       |    |
|-------------|---------|----|----|-------|-------|----|
| LEV-2024LFX | \$1,028 | 75 | 12 | 23.75 | 19.75 | 28 |
| LEV-2030LFX | \$1,053 | 75 | 12 | 29.5  | 19.75 | 28 |
| LEV-2036LFX | \$1,087 | 85 | 15 | 35.5  | 19.75 | 28 |

24" DEEP LATERAL FILE, NO TOP

|             |         |    |    |       |       |    |
|-------------|---------|----|----|-------|-------|----|
| LEV-2424LFX | \$1,095 | 75 | 12 | 23.75 | 23.75 | 28 |
| LEV-2430LFX | \$1,112 | 75 | 12 | 29.5  | 23.75 | 28 |
| LEV-2436LFX | \$1,136 | 85 | 15 | 35.5  | 23.75 | 28 |

- LOCKING DRAWERS
- FITS UNDER WORK SURFACE

**LEVELS SERIES**  
LATERAL FILE STORAGE

| MODEL | LIST | WEIGHT | CUBE            | W  | D  | H  |
|-------|------|--------|-----------------|----|----|----|
|       |      | LBS    | FT <sup>3</sup> | IN | IN | IN |



LEV-2036LF3

**3 DRAWER LATERAL FILE**

20" DEEP

|                    |                |            |           |             |              |              |
|--------------------|----------------|------------|-----------|-------------|--------------|--------------|
| <b>LEV-2036LF3</b> | <b>\$2,156</b> | <b>200</b> | <b>22</b> | <b>35.5</b> | <b>19.75</b> | <b>42.75</b> |
|--------------------|----------------|------------|-----------|-------------|--------------|--------------|

24" DEEP

|                    |                |            |           |             |              |              |
|--------------------|----------------|------------|-----------|-------------|--------------|--------------|
| <b>LEV-2436LF3</b> | <b>\$2,262</b> | <b>222</b> | <b>26</b> | <b>35.5</b> | <b>23.75</b> | <b>42.75</b> |
|--------------------|----------------|------------|-----------|-------------|--------------|--------------|

- INCLUDES ANTI-TILT LOCK



LEV-2036LF4

**4 DRAWER LATERAL FILE**

20" DEEP

|                    |                |            |           |             |              |              |
|--------------------|----------------|------------|-----------|-------------|--------------|--------------|
| <b>LEV-2036LF4</b> | <b>\$2,711</b> | <b>260</b> | <b>29</b> | <b>35.5</b> | <b>19.75</b> | <b>56.25</b> |
|--------------------|----------------|------------|-----------|-------------|--------------|--------------|

24" DEEP

|                    |                |            |           |             |              |              |
|--------------------|----------------|------------|-----------|-------------|--------------|--------------|
| <b>LEV-2436LF4</b> | <b>\$2,801</b> | <b>282</b> | <b>34</b> | <b>35.5</b> | <b>23.75</b> | <b>56.25</b> |
|--------------------|----------------|------------|-----------|-------------|--------------|--------------|

- INCLUDES ANTI-TILT LOCK

**LATERAL FILE BOX/BOXFILE COMBO**

20" DEEP

|                    |                |            |           |             |              |           |
|--------------------|----------------|------------|-----------|-------------|--------------|-----------|
| <b>LEV-2030UFL</b> | <b>\$1,419</b> | <b>120</b> | <b>12</b> | <b>29.5</b> | <b>19.75</b> | <b>29</b> |
|--------------------|----------------|------------|-----------|-------------|--------------|-----------|

|                    |                |            |           |             |              |           |
|--------------------|----------------|------------|-----------|-------------|--------------|-----------|
| <b>LEV-2036UFL</b> | <b>\$1,474</b> | <b>135</b> | <b>15</b> | <b>35.5</b> | <b>19.75</b> | <b>29</b> |
|--------------------|----------------|------------|-----------|-------------|--------------|-----------|

24" DEEP

|                    |                |            |           |             |              |           |
|--------------------|----------------|------------|-----------|-------------|--------------|-----------|
| <b>LEV-2430UFL</b> | <b>\$1,427</b> | <b>150</b> | <b>18</b> | <b>29.5</b> | <b>23.75</b> | <b>29</b> |
|--------------------|----------------|------------|-----------|-------------|--------------|-----------|

|                    |                |            |           |             |              |           |
|--------------------|----------------|------------|-----------|-------------|--------------|-----------|
| <b>LEV-2436UFL</b> | <b>\$1,491</b> | <b>150</b> | <b>18</b> | <b>35.5</b> | <b>23.75</b> | <b>29</b> |
|--------------------|----------------|------------|-----------|-------------|--------------|-----------|

- LOCKING FILE & LATERAL FILE DRAWERS
- OPTIONAL LOCK ON BOX DRAWERS SEE [LEV-6](#)



LEV-2036UFL

**LATERAL BOX/BOXFILE COMBO - NO TOP**

20" DEEP

|                     |                |           |           |             |              |           |
|---------------------|----------------|-----------|-----------|-------------|--------------|-----------|
| <b>LEV-2030UFLX</b> | <b>\$1,353</b> | <b>85</b> | <b>12</b> | <b>29.5</b> | <b>19.75</b> | <b>28</b> |
|---------------------|----------------|-----------|-----------|-------------|--------------|-----------|

|                     |                |            |           |             |              |           |
|---------------------|----------------|------------|-----------|-------------|--------------|-----------|
| <b>LEV-2036UFLX</b> | <b>\$1,405</b> | <b>100</b> | <b>15</b> | <b>35.5</b> | <b>19.75</b> | <b>28</b> |
|---------------------|----------------|------------|-----------|-------------|--------------|-----------|

24" DEEP

|                     |                |            |           |             |              |           |
|---------------------|----------------|------------|-----------|-------------|--------------|-----------|
| <b>LEV-2430UFLX</b> | <b>\$1,359</b> | <b>150</b> | <b>18</b> | <b>29.5</b> | <b>23.75</b> | <b>28</b> |
|---------------------|----------------|------------|-----------|-------------|--------------|-----------|

|                     |                |            |           |             |              |           |
|---------------------|----------------|------------|-----------|-------------|--------------|-----------|
| <b>LEV-2436UFLX</b> | <b>\$1,448</b> | <b>150</b> | <b>18</b> | <b>35.5</b> | <b>23.75</b> | <b>28</b> |
|---------------------|----------------|------------|-----------|-------------|--------------|-----------|

- LOCKING FILE & LATERAL FILE DRAWERS
- FITS UNDER WORK SURFACE
- OPTIONAL LOCK ON BOX DRAWERS SEE [LEV-6](#)



LEV-2036UFLX

| MODEL | LIST | WEIGHT | CUBE            | W  | D  | H  |
|-------|------|--------|-----------------|----|----|----|
|       |      | LBS    | FT <sup>3</sup> | IN | IN | IN |

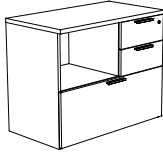

LEV-2036OBBLF

**OPEN LATERAL FILE/BOX/BOX COMBO**

20" DEEP OPEN SHELF/BOX/BOX/LATERAL FILE STORAGE

|               |         |     |      |      |       |    |
|---------------|---------|-----|------|------|-------|----|
| LEV-2030OBBLF | \$1,336 | 120 | 12   | 29.5 | 19.75 | 29 |
| LEV-2036OBBLF | \$1,370 | 160 | 15.5 | 35.5 | 19.75 | 29 |

24" DEEP OPEN SHELF/BOX/BOX/LATERAL FILE STORAGE

|               |         |     |      |      |       |    |
|---------------|---------|-----|------|------|-------|----|
| LEV-2430OBBLF | \$1,379 | 110 | 15   | 29.5 | 23.75 | 29 |
| LEV-2436OBBLF | \$1,425 | 178 | 18.5 | 35.5 | 23.75 | 29 |

- ALL DRAWERS LOCK

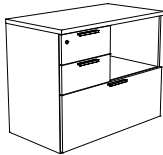

LEV-2036BBOLF

**OPEN LATERAL FILE/BOX/BOX COMBO**

20" DEEP OPEN SHELF/BOX/BOX/LATERAL FILE STORAGE

|               |         |     |      |      |       |    |
|---------------|---------|-----|------|------|-------|----|
| LEV-2030BBOLF | \$1,336 | 120 | 12   | 29.5 | 19.75 | 29 |
| LEV-2036BBOLF | \$1,370 | 178 | 15.5 | 35.5 | 19.75 | 29 |

24" DEEP OPEN SHELF/BOX/BOX/LATERAL FILE STORAGE

|               |         |     |      |      |       |    |
|---------------|---------|-----|------|------|-------|----|
| LEV-2430BBOLF | \$1,379 | 110 | 15   | 29.5 | 23.75 | 29 |
| LEV-2436BBOLF | \$1,425 | 178 | 18.5 | 35.5 | 23.75 | 29 |

- ALL DRAWERS LOCK

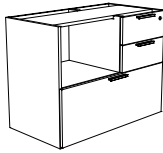

LEV-2036OBBLFX

**OPEN LATERAL FILE/BOX/BOX COMBO - NO TOP**

20" DEEP OPEN SHELF/BOX/BOX/LATERAL FILE STORAGE

|                |         |     |      |      |       |    |
|----------------|---------|-----|------|------|-------|----|
| LEV-2030OBBLFX | \$1,284 | 120 | 12   | 29.5 | 19.75 | 28 |
| LEV-2036OBBLFX | \$1,318 | 141 | 15.5 | 35.5 | 19.75 | 28 |

24" DEEP OPEN SHELF/BOX/BOX/LATERAL FILE STORAGE

|                |         |     |      |      |       |    |
|----------------|---------|-----|------|------|-------|----|
| LEV-2430OBBLFX | \$1,329 | 110 | 15   | 29.5 | 23.75 | 28 |
| LEV-2436OBBLFX | \$1,374 | 178 | 18.5 | 35.5 | 23.75 | 28 |

- ALL DRAWERS LOCK
- FITS UNDER WORK SURFACE



LEV-2036BBOLFX

**OPEN LATERAL FILE/BOX/BOX COMBO - NO TOP**

20" DEEP OPEN SHELF/BOX/BOX/LATERAL FILE STORAGE

|                |         |     |      |      |       |    |
|----------------|---------|-----|------|------|-------|----|
| LEV-2030BBOLFX | \$1,284 | 120 | 12   | 29.5 | 19.75 | 28 |
| LEV-2036BBOLFX | \$1,318 | 141 | 15.5 | 35.5 | 19.75 | 28 |

24" DEEP OPEN SHELF/BOX/BOX/LATERAL FILE STORAGE

|                |         |     |      |      |       |    |
|----------------|---------|-----|------|------|-------|----|
| LEV-2430BBOLFX | \$1,329 | 110 | 15   | 29.5 | 23.75 | 28 |
| LEV-2436BBOLFX | \$1,374 | 178 | 18.5 | 35.5 | 23.75 | 28 |

- ALL DRAWERS LOCK
- FITS UNDER WORK SURFACE

**LEVELS SERIES**  
**LATERAL FILE STORAGE**

| MODEL | LIST | WEIGHT | CUBE            | W  | D  | H  |
|-------|------|--------|-----------------|----|----|----|
|       |      | LBS    | FT <sup>3</sup> | IN | IN | IN |

**OPEN LATERAL FILE STORAGE**

20" DEEP OPEN SHELF/ LATERAL FILE

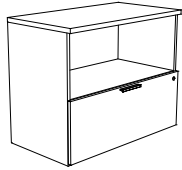

LEV-2036OLF

|             |         |      |      |      |       |    |
|-------------|---------|------|------|------|-------|----|
| LEV-2024OLF | \$962   | 65.3 | 13.3 | 23.5 | 19.75 | 29 |
| LEV-2030OLF | \$1,031 | 75   | 13.3 | 29.5 | 19.75 | 29 |
| LEV-2036OLF | \$1,076 | 85   | 15.5 | 35.5 | 19.75 | 29 |

24" DEEP OPEN SHELF/ LATERAL FILE

|             |         |      |      |      |       |    |
|-------------|---------|------|------|------|-------|----|
| LEV-2424OLF | \$1,012 | 73.3 | 15.5 | 23.5 | 23.75 | 29 |
| LEV-2430OLF | \$1,084 | 90   | 15.5 | 29.5 | 23.75 | 29 |
| LEV-2436OLF | \$1,130 | 95   | 18.5 | 35.5 | 23.75 | 29 |

- LOCKING DRAWERS

**OPEN LATERAL FILE STORAGE W/STORAGE RISER**

20" DEEP OPEN SHELF/ LATERAL FILE

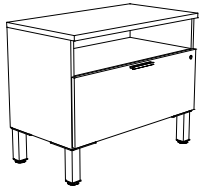

LEV-2036OLF-SR29

|                  |         |      |      |      |       |    |
|------------------|---------|------|------|------|-------|----|
| LEV-2024OLF-SR29 | \$1,000 | 78.3 | 13.3 | 23.5 | 19.75 | 29 |
| LEV-2030OLF-SR29 | \$1,069 | 75   | 13.3 | 29.5 | 19.75 | 29 |
| LEV-2036OLF-SR29 | \$1,107 | 85   | 15.5 | 35.5 | 19.75 | 29 |

24" DEEP OPEN SHELF/ LATERAL FILE

|                  |         |      |      |      |       |    |
|------------------|---------|------|------|------|-------|----|
| LEV-2424OLF-SR29 | \$1,051 | 86.9 | 15.5 | 23.5 | 23.75 | 29 |
| LEV-2430OLF-SR29 | \$1,082 | 90   | 15.5 | 29.5 | 23.75 | 29 |
| LEV-2436OLF-SR29 | \$1,125 | 95   | 18.5 | 35.5 | 23.75 | 29 |

- LOCKING DRAWER

**22" HIGH OPEN LATERAL FILE STORAGE**

20" DEEP OPEN SHELF/ LATERAL FILE

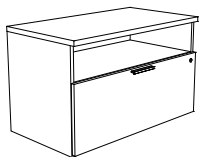

LEV-2036OLF-22

|                |         |      |      |      |       |    |
|----------------|---------|------|------|------|-------|----|
| LEV-2024OLF-22 | \$942   | 57.8 | 13.3 | 23.5 | 19.75 | 22 |
| LEV-2030OLF-22 | \$1,011 | 75   | 13.3 | 29.5 | 19.75 | 22 |
| LEV-2036OLF-22 | \$1,049 | 85   | 15.5 | 35.5 | 19.75 | 22 |

24" DEEP OPEN SHELF/ LATERAL FILE

|                |         |      |      |      |       |    |
|----------------|---------|------|------|------|-------|----|
| LEV-2424OLF-22 | \$993   | 64.8 | 15.5 | 23.5 | 23.75 | 22 |
| LEV-2430OLF-22 | \$1,024 | 90   | 15.5 | 29.5 | 23.75 | 22 |
| LEV-2436OLF-22 | \$1,067 | 95   | 18.5 | 35.5 | 23.75 | 22 |

- LOCKING DRAWER



| MODEL | LIST | WEIGHT | CUBE            | W  | D  | H  |
|-------|------|--------|-----------------|----|----|----|
|       |      | LBS    | FT <sup>3</sup> | IN | IN | IN |

**OPEN LATERAL FILE STORAGE - NO TOP**

20" DEEP OPEN SHELF/ LATERAL FILE, NO TOP

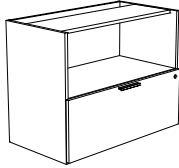

LEV-2036OLFX

|              |              |      |     |       |       |    |
|--------------|--------------|------|-----|-------|-------|----|
| LEV-2024OLFX | <b>\$886</b> | 57.8 | 7.3 | 23.75 | 19.75 | 28 |
| LEV-2030OLFX | <b>\$900</b> | 65.5 | 9.1 | 29.5  | 19.75 | 28 |
| LEV-2036OLFX | <b>\$962</b> | 73.1 | 11  | 35.5  | 19.75 | 28 |

24" DEEP OPEN SHELF/ LATERAL FILE, NO TOP

|              |                |      |      |       |       |    |
|--------------|----------------|------|------|-------|-------|----|
| LEV-2424OLFX | <b>\$1,006</b> | 63.5 | 8.8  | 23.75 | 23.75 | 28 |
| LEV-2430OLFX | <b>\$1,022</b> | 71.5 | 11   | 29.5  | 23.75 | 28 |
| LEV-2436OLFX | <b>\$1,094</b> | 79.5 | 13.2 | 35.5  | 23.75 | 28 |

- LOCKING DRAWER
- FITS UNDER WORK SURFACE

**OPEN LATERAL FILE STORAGE - NO TOP W/ STORAGE RISER**

20" DEEP OPEN SHELF/ LATERAL FILE, NO TOP

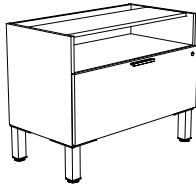

LEV-2036OLFX-SR28

|                   |              |      |     |       |       |    |
|-------------------|--------------|------|-----|-------|-------|----|
| LEV-2024OLFX-SR28 | <b>\$917</b> | 70.8 | 7.3 | 23.75 | 19.75 | 28 |
| LEV-2030OLFX-SR28 | <b>\$939</b> | 79.6 | 9.1 | 29.5  | 19.75 | 28 |
| LEV-2036OLFX-SR28 | <b>\$992</b> | 88.4 | 11  | 35.5  | 19.75 | 28 |

24" DEEP OPEN SHELF/ LATERAL FILE, NO TOP

|                   |                |      |      |       |       |    |
|-------------------|----------------|------|------|-------|-------|----|
| LEV-2424OLFX-SR28 | <b>\$1,033</b> | 77   | 8.8  | 23.75 | 23.75 | 28 |
| LEV-2430OLFX-SR28 | <b>\$1,059</b> | 86.7 | 11   | 29.5  | 23.75 | 28 |
| LEV-2436OLFX-SR28 | <b>\$1,118</b> | 96.3 | 13.2 | 35.5  | 23.75 | 28 |

- LOCKING DRAWER
- FITS UNDER WORK SURFACE

**21" HIGH OPEN LATERAL FILE STORAGE - NO TOP**

20" DEEP OPEN SHELF/ LATERAL FILE, NO TOP

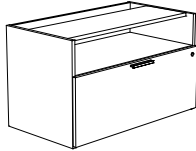

LEV-2036OLFX-21

|                 |              |      |     |       |       |    |
|-----------------|--------------|------|-----|-------|-------|----|
| LEV-2024OLFX-21 | <b>\$859</b> | 50.3 | 5.5 | 23.75 | 19.75 | 21 |
| LEV-2030OLFX-21 | <b>\$881</b> | 57.1 | 6.9 | 29.5  | 19.75 | 21 |
| LEV-2036OLFX-21 | <b>\$934</b> | 64   | 8.7 | 35.5  | 19.75 | 21 |

24" DEEP OPEN SHELF/ LATERAL FILE, NO TOP

|                 |                |      |     |       |       |    |
|-----------------|----------------|------|-----|-------|-------|----|
| LEV-2424OLFX-21 | <b>\$975</b>   | 54.9 | 6.6 | 23.75 | 23.75 | 21 |
| LEV-2430OLFX-21 | <b>\$1,001</b> | 62.2 | 8.2 | 29.5  | 23.75 | 21 |
| LEV-2436OLFX-21 | <b>\$1,060</b> | 69.5 | 9.9 | 35.5  | 23.75 | 21 |

- LOCKING DRAWER
- FITS UNDER WORK SURFACE

| MODEL | LIST | WEIGHT | CUBE            | W  | D  | H  |
|-------|------|--------|-----------------|----|----|----|
|       |      | LBS    | FT <sup>3</sup> | IN | IN | IN |

**WIDE DRAWER OVER LATERAL FILE W/ STORAGE RISER**

20" DEEP WIDE DRAWER/ LATERAL FILE

|                   |         |       |      |       |       |    |
|-------------------|---------|-------|------|-------|-------|----|
| LEV-2024WDLF-SR29 | \$1,227 | 83.9  | 7.7  | 23.75 | 19.75 | 29 |
| LEV-2030WDLF-SR29 | \$1,258 | 93.2  | 9.6  | 29.5  | 19.75 | 29 |
| LEV-2036WDLF-SR29 | \$1,320 | 102.6 | 13.6 | 35.5  | 19.75 | 29 |

24" DEEP WIDE DRAWER/ LATERAL FILE

|                   |         |       |      |       |       |    |
|-------------------|---------|-------|------|-------|-------|----|
| LEV-2424WDLF-SR29 | \$1,290 | 90.9  | 11   | 23.75 | 23.75 | 29 |
| LEV-2430WDLF-SR29 | \$1,320 | 101.2 | 13.6 | 29.5  | 23.75 | 29 |
| LEV-2436WDLF-SR29 | \$1,383 | 111.6 | 16.1 | 35.5  | 23.75 | 29 |

- LOCKING DRAWERS
- MUST SECURE TO WALL IF STANDALONE, OR GANG TO ADJACENT UNITS FOR STABILITY

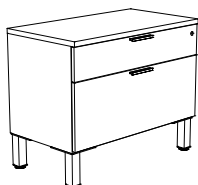

LEV-2036WDLF-SR29

**22" HIGH WIDE DRAWER OVER LATERAL FILE**

20" DEEP WIDE DRAWER/ LATERAL FILE

|                 |         |      |      |       |       |    |
|-----------------|---------|------|------|-------|-------|----|
| LEV-2024WDLF-22 | \$1,169 | 63.4 | 7.1  | 23.75 | 19.75 | 22 |
| LEV-2030WDLF-22 | \$1,200 | 70.8 | 8.8  | 29.5  | 19.75 | 22 |
| LEV-2036WDLF-22 | \$1,262 | 78.2 | 10.4 | 35.5  | 19.75 | 22 |

24" DEEP WIDE DRAWER/ LATERAL FILE

|                 |         |      |      |       |       |    |
|-----------------|---------|------|------|-------|-------|----|
| LEV-2424WDLF-22 | \$1,232 | 68.7 | 8.4  | 23.75 | 23.75 | 22 |
| LEV-2430WDLF-22 | \$1,262 | 76.8 | 10.4 | 29.5  | 23.75 | 22 |
| LEV-2436WDLF-22 | \$1,325 | 84.8 | 12.3 | 35.5  | 23.75 | 22 |

- LOCKING DRAWERS
- MUST SECURE TO WALL IF STANDALONE, OR GANG TO ADJACENT UNITS FOR STABILITY

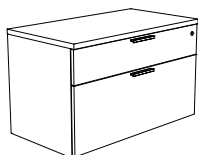

LEV-2036WDLF-22

**WIDE DRAWER OVER LATERAL FILE - NO TOP W/ STORAGE RISER**

20" DEEP WIDE DRAWER/ LATERAL FILE, NO TOP

|                    |         |      |     |       |       |    |
|--------------------|---------|------|-----|-------|-------|----|
| LEV-2024WDLFX-SR28 | \$1,189 | 76.4 | 8.9 | 23.75 | 19.75 | 28 |
| LEV-2030WDLFX-SR28 | \$1,220 | 83.9 | 11  | 29.5  | 19.75 | 28 |
| LEV-2036WDLFX-SR28 | \$1,281 | 91.5 | 13  | 35.5  | 19.75 | 28 |

24" DEEP WIDE DRAWER/ LATERAL FILE, NO TOP

|                    |         |    |      |       |       |    |
|--------------------|---------|----|------|-------|-------|----|
| LEV-2424WDLFX-SR28 | \$1,252 | 81 | 10.5 | 23.75 | 23.75 | 28 |
| LEV-2430WDLFX-SR28 | \$1,281 | 89 | 13   | 29.5  | 23.75 | 28 |
| LEV-2436WDLFX-SR28 | \$1,345 | 97 | 15.4 | 35.5  | 23.75 | 28 |

- LOCKING DRAWERS
- MUST SECURE TO WALL IF STANDALONE, OR GANG TO ADJACENT UNITS FOR STABILITY

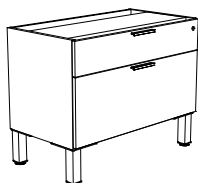

LEV-2036WDLFX-SR28

| MODEL | LIST | *AGD<br>UPCHARGE | WEIGHT<br>LBS | CUBE<br>FT <sup>3</sup> | W<br>IN | D<br>IN | H<br>IN |
|-------|------|------------------|---------------|-------------------------|---------|---------|---------|
|-------|------|------------------|---------------|-------------------------|---------|---------|---------|

**21" HIGH WIDE DRAWER OVER LATERAL FILE - NO TOP**

20" DEEP WIDE DRAWER/ LATERAL FILE, NO TOP

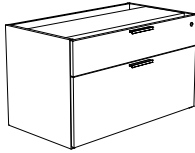

LEV-2036WDLFX-21

|                  |                |     |      |     |       |       |    |
|------------------|----------------|-----|------|-----|-------|-------|----|
| LEV-2024WDLFX-21 | <b>\$1,131</b> | N/A | 55.9 | 6.7 | 23.75 | 19.75 | 21 |
| LEV-2030WDLFX-21 | <b>\$1,162</b> | N/A | 61.5 | 8.3 | 29.5  | 19.75 | 21 |
| LEV-2036WDLFX-21 | <b>\$1,223</b> | N/A | 67.1 | 9.8 | 35.5  | 19.75 | 21 |

24" DEEP WIDE DRAWER/ LATERAL FILE, NO TOP

|                  |                |     |      |      |       |       |    |
|------------------|----------------|-----|------|------|-------|-------|----|
| LEV-2424WDLFX-21 | <b>\$1,194</b> | N/A | 58.9 | 7.9  | 23.75 | 23.75 | 21 |
| LEV-2430WDLFX-21 | <b>\$1,223</b> | N/A | 64.5 | 9.8  | 29.5  | 23.75 | 21 |
| LEV-2436WDLFX-21 | <b>\$1,287</b> | N/A | 70.1 | 11.6 | 35.5  | 23.75 | 21 |

- LOCKING DRAWERS
- FITS UNDER WORK SURFACE
- MUST SECURE TO WALL IF STANDALONE, OR GANG TO ADJACENT UNITS FOR STABILITY

**CABINET STORAGE**

**\*OPTIONAL AGD (ALUMINIUM GLAZED DOORS) DOORS**

- AGD DOORS INCLUDE SILVER FINISH BAR HANDLES
- THE PRICE SHOWN FOR AGD DOORS IS AN UPCHARGE THAT MUST BE ADDED TO THE BASE PRICE OF THE UNIT IT GOES ON

AGD FINISHES CLEAR (CL), FROSTED (FR) OR BRONZE (BR)

**DOUBLE DOOR CABINET**

20" DEEP W/ 1 ADJUSTABLE SHELF

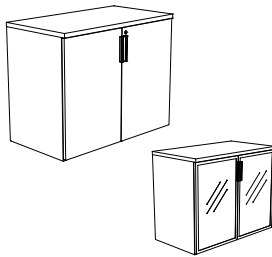

LEV-2036C  
LEV-2036C-AGD

|           |              |       |     |    |      |       |    |
|-----------|--------------|-------|-----|----|------|-------|----|
| LEV-2030C | <b>\$871</b> | \$558 | 100 | 13 | 29.5 | 19.75 | 29 |
| LEV-2036C | <b>\$913</b> | \$572 | 115 | 15 | 35.5 | 19.75 | 29 |

24" DEEP W/ 1 ADJUSTABLE SHELF

|           |              |       |     |    |      |       |    |
|-----------|--------------|-------|-----|----|------|-------|----|
| LEV-2430C | <b>\$946</b> | \$558 | 110 | 15 | 29.5 | 23.75 | 29 |
| LEV-2436C | <b>\$978</b> | \$572 | 125 | 18 | 35.5 | 23.75 | 29 |

- LOCKING DOORS

**DOUBLE DOOR CABINET W/ STORAGE RISER**

20" DEEP W/ 1 ADJUSTABLE SHELF

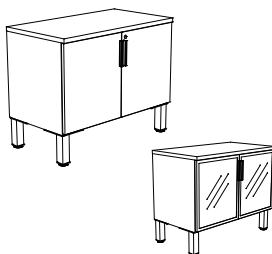

LEV-2036C-SR29  
LEV-2036C-SR29-AGD

|                |              |       |     |    |      |       |    |
|----------------|--------------|-------|-----|----|------|-------|----|
| LEV-2030C-SR29 | <b>\$889</b> | \$532 | 100 | 13 | 29.5 | 19.75 | 29 |
| LEV-2036C-SR29 | <b>\$944</b> | \$544 | 115 | 15 | 35.5 | 19.75 | 29 |

24" DEEP W/ 1 ADJUSTABLE SHELF

|                |                |       |     |    |      |       |    |
|----------------|----------------|-------|-----|----|------|-------|----|
| LEV-2430C-SR29 | <b>\$964</b>   | \$532 | 110 | 15 | 29.5 | 23.75 | 29 |
| LEV-2436C-SR29 | <b>\$1,014</b> | \$544 | 125 | 18 | 35.5 | 23.75 | 29 |

- LOCKING DOORS

| MODEL | LIST     | *AGD | WEIGHT | CUBE            | W  | D  | H  |
|-------|----------|------|--------|-----------------|----|----|----|
|       | UPCHARGE |      | LBS    | FT <sup>3</sup> | IN | IN | IN |

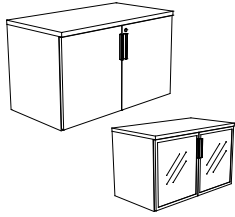

LEV-2036C-22  
LEV-2036C-22-AGD

**22" HIGH DOUBLE DOOR CABINET**

20" DEEP W/ 1 ADJUSTABLE SHELF

|              |              |              |     |    |      |       |    |
|--------------|--------------|--------------|-----|----|------|-------|----|
| LEV-2030C-22 | <b>\$831</b> | <i>\$532</i> | 100 | 13 | 29.5 | 19.75 | 22 |
| LEV-2036C-22 | <b>\$886</b> | <i>\$544</i> | 115 | 15 | 35.5 | 19.75 | 22 |

24" DEEP W/ 1 ADJUSTABLE SHELF

|              |              |              |     |      |      |       |    |
|--------------|--------------|--------------|-----|------|------|-------|----|
| LEV-2430C-22 | <b>\$906</b> | <i>\$532</i> | 110 | 15   | 29.5 | 23.75 | 22 |
| LEV-2436C-22 | <b>\$956</b> | <i>\$544</i> | 178 | 18.5 | 35.5 | 23.75 | 22 |

- LOCKING DOORS

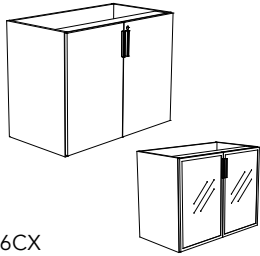

LEV-2036CX  
LEV-2036CX-AGD

**DOUBLE DOOR CABINET - NO TOP**

20" DEEP W/ 1 ADJUSTABLE SHELF

|            |              |              |     |    |      |       |    |
|------------|--------------|--------------|-----|----|------|-------|----|
| LEV-2030CX | <b>\$844</b> | <i>\$558</i> | 85  | 12 | 29.5 | 19.75 | 28 |
| LEV-2036CX | <b>\$871</b> | <i>\$572</i> | 101 | 15 | 35.5 | 19.75 | 28 |

24" DEEP W/ 1 ADJUSTABLE SHELF

|            |              |              |     |    |      |       |    |
|------------|--------------|--------------|-----|----|------|-------|----|
| LEV-2430CX | <b>\$855</b> | <i>\$558</i> | 106 | 17 | 29.5 | 23.75 | 28 |
| LEV-2436CX | <b>\$883</b> | <i>\$572</i> | 122 | 22 | 35.5 | 23.75 | 28 |

- LOCKING DOORS
- FITS UNDER WORK SURFACE

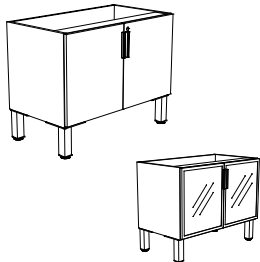

LEV-2036CX-SR28  
LEV-2036CX-SR28-AGD

**DOUBLE DOOR CABINET - NO TOP W/ STORAGE RISERS**

20" DEEP W 1 ADJUSTABLE SHELF

|                 |              |              |     |    |      |       |    |
|-----------------|--------------|--------------|-----|----|------|-------|----|
| LEV-2030CX-SR28 | <b>\$872</b> | <i>\$532</i> | 120 | 12 | 29.5 | 19.75 | 28 |
| LEV-2036CX-SR28 | <b>\$910</b> | <i>\$544</i> | 115 | 15 | 35.5 | 19.75 | 28 |

24" DEEP W 1 ADJUSTABLE SHELF

|                 |              |              |     |    |      |       |    |
|-----------------|--------------|--------------|-----|----|------|-------|----|
| LEV-2430CX-SR28 | <b>\$884</b> | <i>\$532</i> | 141 | 17 | 29.5 | 23.75 | 28 |
| LEV-2436CX-SR28 | <b>\$922</b> | <i>\$544</i> | 136 | 22 | 35.5 | 23.75 | 28 |

- LOCKING DOORS
- FITS UNDER WORK SURFACE

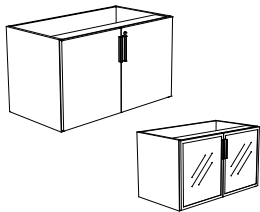

LEV-2036CX-21  
LEV-2036CX-21-AGD

**21" HIGH DOUBLE DOOR CABINET - NO TOP**

20" DEEP W/ 1 ADJUSTABLE SHELF

|               |              |              |     |    |      |       |    |
|---------------|--------------|--------------|-----|----|------|-------|----|
| LEV-2030CX-21 | <b>\$814</b> | <i>\$532</i> | 120 | 12 | 29.5 | 19.75 | 21 |
| LEV-2036CX-21 | <b>\$852</b> | <i>\$544</i> | 115 | 15 | 35.5 | 19.75 | 21 |

24" DEEP W/ 1 ADJUSTABLE SHELF

|               |              |              |     |    |      |       |    |
|---------------|--------------|--------------|-----|----|------|-------|----|
| LEV-2430CX-21 | <b>\$826</b> | <i>\$532</i> | 141 | 17 | 29.5 | 23.75 | 21 |
| LEV-2436CX-21 | <b>\$864</b> | <i>\$544</i> | 136 | 22 | 35.5 | 23.75 | 21 |

- LOCKING DOORS
- FITS UNDER WORK SURFACE

| MODEL | LIST      | *AGD | WEIGHT | CUBE            | W  | D  | H  |
|-------|-----------|------|--------|-----------------|----|----|----|
|       | UP CHARGE |      | LBS    | FT <sup>3</sup> | IN | IN | IN |

**CABINET - DRAWERS OVER DOORS**

20" DEEP W/ 1 ADJUSTABLE SHELF

|            |                |       |     |      |      |       |    |
|------------|----------------|-------|-----|------|------|-------|----|
| LEV-2030DC | <b>\$1,233</b> | \$519 | 105 | 10.6 | 29.5 | 19.75 | 29 |
| LEV-2036DC | <b>\$1,274</b> | \$532 | 120 | 12.8 | 35.5 | 19.75 | 29 |

24" DEEP W/ 1 ADJUSTABLE SHELF

|            |                |       |     |      |      |       |    |
|------------|----------------|-------|-----|------|------|-------|----|
| LEV-2430DC | <b>\$1,244</b> | \$519 | 126 | 15.5 | 29.5 | 23.75 | 29 |
| LEV-2436DC | <b>\$1,368</b> | \$532 | 145 | 18.5 | 35.5 | 23.75 | 29 |

- LOCKING DOORS
- OPTIONAL LOCK ON BOX DRAWERS SEE [LEV-6](#)

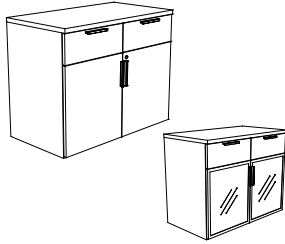

LEV-2036DC  
LEV-2036DC-AGD

**DRAWER OVER DOUBLE DOOR CABINET W/ STORAGE RISER**

20" DEEP W/ 1 ADJUSTABLE SHELF

|                 |                |       |     |      |      |       |    |
|-----------------|----------------|-------|-----|------|------|-------|----|
| LEV-2030DC-SR29 | <b>\$1,274</b> | \$507 | 105 | 10.6 | 29.5 | 19.75 | 29 |
| LEV-2036DC-SR29 | <b>\$1,310</b> | \$519 | 120 | 12.8 | 35.5 | 19.75 | 29 |

24" DEEP W/ 1 ADJUSTABLE SHELF

|                 |                |       |     |      |      |       |    |
|-----------------|----------------|-------|-----|------|------|-------|----|
| LEV-2430DC-SR29 | <b>\$1,285</b> | \$507 | 126 | 15.5 | 29.5 | 23.75 | 29 |
| LEV-2436DC-SR29 | <b>\$1,411</b> | \$519 | 145 | 18.5 | 35.5 | 23.75 | 29 |

- LOCKING DOORS
- OPTIONAL LOCK ON BOX DRAWERS SEE [LEV-6](#)

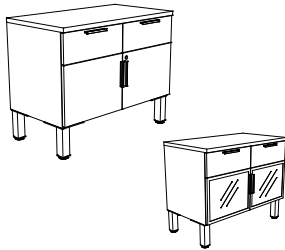

LEV-2036DC-SR29  
LEV-2036DC-SR29-AGD

**22" HIGH CABINET - DRAWERS OVER DOORS**

20" DEEP W/ 1 ADJUSTABLE SHELF

|               |                |       |     |    |      |       |    |
|---------------|----------------|-------|-----|----|------|-------|----|
| LEV-2030DC-22 | <b>\$1,216</b> | \$507 | 120 | 12 | 29.5 | 19.75 | 22 |
| LEV-2036DC-22 | <b>\$1,252</b> | \$519 | 115 | 15 | 35.5 | 19.75 | 22 |

24" DEEP W/ 1 ADJUSTABLE SHELF

|               |                |       |     |      |      |       |    |
|---------------|----------------|-------|-----|------|------|-------|----|
| LEV-2430DC-22 | <b>\$1,227</b> | \$507 | 110 | 15   | 29.5 | 23.75 | 22 |
| LEV-2436DC-22 | <b>\$1,353</b> | \$519 | 178 | 18.5 | 35.5 | 23.75 | 22 |

- LOCKING DOORS
- OPTIONAL LOCK ON BOX DRAWERS SEE [LEV-6](#)

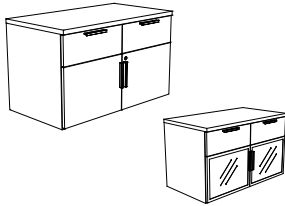

LEV-2036DC-22  
LEV-2036DC-22-AGD

**CABINET - DRAWERS OVER DOORS - NO TOP**

20" DEEP W/ 1 ADJUSTABLE SHELF

|             |                |       |     |      |      |       |    |
|-------------|----------------|-------|-----|------|------|-------|----|
| LEV-2030DCX | <b>\$1,204</b> | \$519 | 130 | 10.6 | 29.5 | 19.75 | 28 |
| LEV-2036DCX | <b>\$1,248</b> | \$532 | 115 | 15   | 35.5 | 19.75 | 28 |

24" DEEP W/ 1 ADJUSTABLE SHELF

|             |                |       |     |      |      |       |    |
|-------------|----------------|-------|-----|------|------|-------|----|
| LEV-2430DCX | <b>\$1,237</b> | \$519 | 130 | 10.6 | 29.5 | 23.75 | 28 |
| LEV-2436DCX | <b>\$1,279</b> | \$532 | 115 | 15   | 35.5 | 23.75 | 28 |

- LOCKING DOORS
- FITS UNDER WORK SURFACE
- OPTIONAL LOCK ON BOX DRAWERS SEE [LEV-6](#)

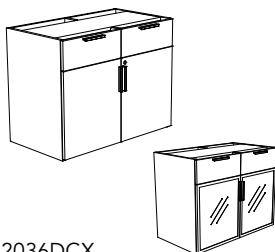

LEV-2036DCX  
LEV-2036DCX-AGD

| MODEL | LIST     | *AGD | WEIGHT | CUBE            | W  | D  | H  |
|-------|----------|------|--------|-----------------|----|----|----|
|       | UPCHARGE |      | LBS    | FT <sup>3</sup> | IN | IN | IN |

**DRAWERS OVER DOORS CABINET - NO TOP W/ STORAGE RISERS**

20" DEEP W/ 1 ADJUSTABLE SHELF

|                  |                |              |     |    |      |       |    |
|------------------|----------------|--------------|-----|----|------|-------|----|
| LEV-2030DCX-SR28 | <b>\$1,242</b> | <i>\$507</i> | 120 | 12 | 29.5 | 19.75 | 28 |
| LEV-2036DCX-SR28 | <b>\$1,278</b> | <i>\$519</i> | 115 | 15 | 35.5 | 19.75 | 28 |

24" DEEP W/ 1 ADJUSTABLE SHELF

|                  |                |              |     |    |      |       |    |
|------------------|----------------|--------------|-----|----|------|-------|----|
| LEV-2430DCX-SR28 | <b>\$1,256</b> | <i>\$507</i> | 120 | 12 | 29.5 | 23.75 | 28 |
| LEV-2436DCX-SR28 | <b>\$1,296</b> | <i>\$519</i> | 115 | 15 | 35.5 | 23.75 | 28 |

- FITS UNDER WORK SURFACE
- LOCKING DOORS
- OPTIONAL LOCK ON BOX DRAWERS SEE [LEV-6](#)

**21" HIGH DRAWERS OVER DOORS CABINET - NO TOP**

20" DEEP W 1 ADJUSTABLE SHELF

|                |                |              |     |    |      |       |    |
|----------------|----------------|--------------|-----|----|------|-------|----|
| LEV-2030DCX-21 | <b>\$1,184</b> | <i>\$507</i> | 120 | 12 | 29.5 | 19.75 | 21 |
| LEV-2036DCX-21 | <b>\$1,220</b> | <i>\$519</i> | 115 | 15 | 35.5 | 19.75 | 21 |

24" DEEP W/ 1 ADJUSTABLE SHELF

|                |                |              |     |    |      |       |    |
|----------------|----------------|--------------|-----|----|------|-------|----|
| LEV-2430DCX-21 | <b>\$1,198</b> | <i>\$507</i> | 120 | 12 | 29.5 | 23.75 | 21 |
| LEV-2436DCX-21 | <b>\$1,238</b> | <i>\$519</i> | 115 | 15 | 35.5 | 23.75 | 21 |

- LOCKING DOORS
- FITS UNDER WORK SURFACE
- OPTIONAL LOCK ON BOX DRAWERS SEE [LEV-6](#)

**CABINET - WIDE DRAWER OVER 2 DOOR CABINET**

20" DEEP W/ 1 ADJUSTABLE SHELF

|             |                |              |     |      |       |       |    |
|-------------|----------------|--------------|-----|------|-------|-------|----|
| LEV-2030WDC | <b>\$1,275</b> | <i>\$519</i> | 105 | 10.6 | 29.75 | 19.75 | 29 |
| LEV-2036WDC | <b>\$1,357</b> | <i>\$532</i> | 120 | 12.8 | 35.5  | 19.75 | 29 |

24" DEEP W/ 1 ADJUSTABLE SHELF

|             |                |              |     |      |      |       |    |
|-------------|----------------|--------------|-----|------|------|-------|----|
| LEV-2430WDC | <b>\$1,302</b> | <i>\$519</i> | 126 | 15.5 | 29.5 | 23.75 | 29 |
| LEV-2436WDC | <b>\$1,373</b> | <i>\$532</i> | 145 | 18.5 | 35.5 | 23.75 | 29 |

- LOCKING DOORS
- OPTIONAL LOCK ON DRAWER SEE [LEV-6](#)

**WIDE DRAWER OVER 2 DOOR CABINET W/ STORAGE RISER**

20" DEEP W/ 1 ADJUSTABLE SHELF

|                  |                |              |     |      |      |       |    |
|------------------|----------------|--------------|-----|------|------|-------|----|
| LEV-2030WDC-SR29 | <b>\$1,290</b> | <i>\$507</i> | 105 | 10.6 | 29.5 | 19.75 | 29 |
| LEV-2036WDC-SR29 | <b>\$1,371</b> | <i>\$519</i> | 120 | 12.8 | 35.5 | 19.75 | 29 |

24" DEEP W/ 1 ADJUSTABLE SHELF

|                  |                |              |     |      |      |       |    |
|------------------|----------------|--------------|-----|------|------|-------|----|
| LEV-2430WDC-SR29 | <b>\$1,338</b> | <i>\$507</i> | 126 | 15.5 | 29.5 | 23.75 | 29 |
| LEV-2436WDC-SR29 | <b>\$1,382</b> | <i>\$519</i> | 145 | 18.5 | 35.5 | 23.75 | 29 |

- LOCKING DOORS
- OPTIONAL LOCK ON DRAWER SEE [LEV-6](#)

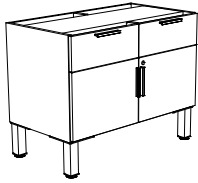

LEV-2036DCX-SR28  
LEV-2036DCX-SR28-AGD

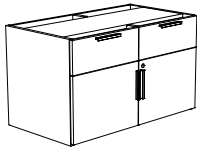
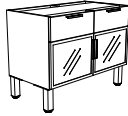

LEV-2036DCX-21  
LEV-2036DCX-21-AGD

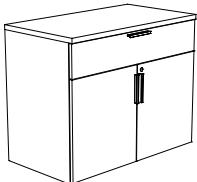
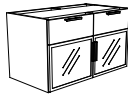

LEV-2036WDC  
LEV-2036WDC-AGD

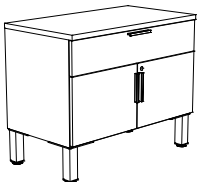
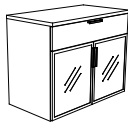

LEV-2036WDC-SR29  
LEV-2036WDC-SR29-AGD



| MODEL | LIST     | *AGD | WEIGHT | CUBE            | W  | D  | H  |
|-------|----------|------|--------|-----------------|----|----|----|
|       | UPCHARGE |      | LBS    | FT <sup>3</sup> | IN | IN | IN |

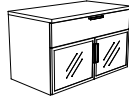
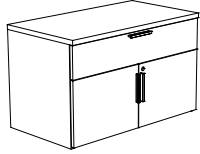

LEV-2036WDC-22  
LEV-2036WDC-22-AGD

**22" HIGH CABINET - WIDE DRAWER OVER 2 DOOR CABINET**

20" DEEP W/ 1 ADJUSTABLE SHELF

|                |                |              |     |    |      |       |    |
|----------------|----------------|--------------|-----|----|------|-------|----|
| LEV-2030WDC-22 | <b>\$1,232</b> | <i>\$507</i> | 120 | 12 | 29.5 | 19.75 | 22 |
|----------------|----------------|--------------|-----|----|------|-------|----|

|                |                |              |     |    |      |       |    |
|----------------|----------------|--------------|-----|----|------|-------|----|
| LEV-2036WDC-22 | <b>\$1,313</b> | <i>\$519</i> | 115 | 15 | 35.5 | 19.75 | 22 |
|----------------|----------------|--------------|-----|----|------|-------|----|

24" DEEP W/ 1 ADJUSTABLE SHELF

|                |                |              |     |    |      |       |    |
|----------------|----------------|--------------|-----|----|------|-------|----|
| LEV-2430WDC-22 | <b>\$1,280</b> | <i>\$507</i> | 110 | 15 | 29.5 | 23.75 | 22 |
|----------------|----------------|--------------|-----|----|------|-------|----|

|                |                |              |     |      |      |       |    |
|----------------|----------------|--------------|-----|------|------|-------|----|
| LEV-2436WDC-22 | <b>\$1,324</b> | <i>\$519</i> | 178 | 18.5 | 35.5 | 23.75 | 22 |
|----------------|----------------|--------------|-----|------|------|-------|----|

- LOCKING DOORS
- OPTIONAL LOCK ON DRAWER SEE [LEV-6](#)

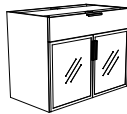
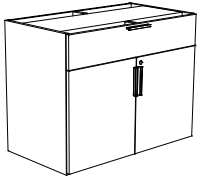

LEV-2036WDCX  
LEV-2036WDCX-AGD

**CABINET - WIDE DRAWER OVER 2 DOOR CABINET - NO TOP**

1 ADJUSTABLE SHELF

|              |                |              |     |      |      |       |    |
|--------------|----------------|--------------|-----|------|------|-------|----|
| LEV-2030WDCX | <b>\$1,195</b> | <i>\$519</i> | 102 | 10.6 | 29.5 | 19.75 | 28 |
|--------------|----------------|--------------|-----|------|------|-------|----|

|              |                |              |     |      |      |       |    |
|--------------|----------------|--------------|-----|------|------|-------|----|
| LEV-2036WDCX | <b>\$1,275</b> | <i>\$532</i> | 130 | 12.8 | 35.5 | 19.75 | 28 |
|--------------|----------------|--------------|-----|------|------|-------|----|

- LOCKING DOORS
- FITS UNDER WORK SURFACE
- OPTIONAL LOCK ON DRAWER SEE [LEV-6](#)

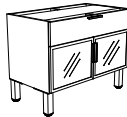
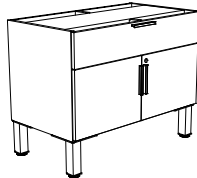

LEV-2036WDCX-SR28  
LEV-2036WDCX-SR28-AGD

**CABINET - WIDE DRAWER OVER 2 DOOR CABINET - NO TOP W/ STORAGE RISER**

1 ADJUSTABLE SHELF

|                   |                |              |     |    |      |       |    |
|-------------------|----------------|--------------|-----|----|------|-------|----|
| LEV-2030WDCX-SR28 | <b>\$1,209</b> | <i>\$507</i> | 120 | 12 | 29.5 | 19.75 | 28 |
|-------------------|----------------|--------------|-----|----|------|-------|----|

|                   |                |              |     |    |      |       |    |
|-------------------|----------------|--------------|-----|----|------|-------|----|
| LEV-2036WDCX-SR28 | <b>\$1,291</b> | <i>\$519</i> | 115 | 15 | 35.5 | 19.75 | 28 |
|-------------------|----------------|--------------|-----|----|------|-------|----|

- LOCKING DOORS
- FITS UNDER WORK SURFACE
- OPTIONAL LOCK ON DRAWER SEE [LEV-6](#)

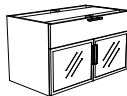
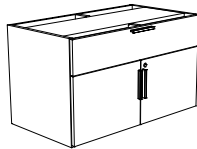

LEV-2036WDCX-21  
LEV-2036WDCX-21-AGD

**21" HIGH CABINET - WIDE DRAWER OVER 2 DOOR CABINET - NO TOP**

1 ADJUSTABLE SHELF

|                 |                |              |     |      |      |       |    |
|-----------------|----------------|--------------|-----|------|------|-------|----|
| LEV-2030WDCX-21 | <b>\$1,151</b> | <i>\$507</i> | 120 | 10.6 | 29.5 | 19.75 | 21 |
|-----------------|----------------|--------------|-----|------|------|-------|----|

|                 |                |              |     |    |      |       |    |
|-----------------|----------------|--------------|-----|----|------|-------|----|
| LEV-2036WDCX-21 | <b>\$1,233</b> | <i>\$519</i> | 115 | 15 | 35.5 | 19.75 | 21 |
|-----------------|----------------|--------------|-----|----|------|-------|----|

- LOCKING DOORS
- FITS UNDER WORK SURFACE
- OPTIONAL LOCK ON DRAWER SEE [LEV-6](#)

| MODEL | LIST     | *AGD | WEIGHT | CUBE            | W  | D  | H  |
|-------|----------|------|--------|-----------------|----|----|----|
|       | UPCHARGE |      | LBS    | FT <sup>3</sup> | IN | IN | IN |

**\*OPTIONAL AGD (ALUMINIUM GLAZED DOORS) DOORS**

- AGD DOORS INCLUDE SILVER FINISH BAR HANDLES
- THE PRICE SHOWN FOR AGD DOORS IS AN UPCHARGE THAT MUST BE ADDED TO THE BASE PRICE OF THE UNIT IT GOES ON

AGD FINISHES CLEAR (CL), FROSTED (FR) OR BRONZE (BR)

**SINGLE DOOR CABINET**

20" DEEP W/ 1 ADJUSTABLE SHELF & LOCKING DOOR HINGED LEFT

|             |              |              |    |   |       |       |    |
|-------------|--------------|--------------|----|---|-------|-------|----|
| LEV-2018CLH | <b>\$784</b> | <i>\$288</i> | 59 | 6 | 17.75 | 19.75 | 29 |
| LEV-2024CLH | <b>\$820</b> | <i>\$330</i> | 78 | 8 | 23.75 | 19.75 | 29 |

24" DEEP W/ 1 ADJUSTABLE SHELF & LOCKING DOOR HINGED LEFT

|             |              |              |    |      |       |       |    |
|-------------|--------------|--------------|----|------|-------|-------|----|
| LEV-2418CLH | <b>\$834</b> | <i>\$288</i> | 82 | 9    | 17.75 | 23.75 | 29 |
| LEV-2424CLH | <b>\$851</b> | <i>\$330</i> | 92 | 10.5 | 23.75 | 23.75 | 29 |

- LOCKING DOOR HINGED LEFT

20" DEEP W/ 1 ADJUSTABLE SHELF & LOCKING DOOR HINGED RIGHT

|             |              |              |    |   |       |       |    |
|-------------|--------------|--------------|----|---|-------|-------|----|
| LEV-2018CRH | <b>\$784</b> | <i>\$288</i> | 59 | 6 | 17.75 | 19.75 | 29 |
| LEV-2024CRH | <b>\$820</b> | <i>\$330</i> | 78 | 8 | 23.75 | 19.75 | 29 |

24" DEEP W/ 1 ADJUSTABLE SHELF & LOCKING DOOR HINGED RIGHT

|             |              |              |    |      |       |       |    |
|-------------|--------------|--------------|----|------|-------|-------|----|
| LEV-2418CRH | <b>\$834</b> | <i>\$288</i> | 82 | 9    | 17.75 | 23.75 | 29 |
| LEV-2424CRH | <b>\$851</b> | <i>\$330</i> | 92 | 10.5 | 23.75 | 23.75 | 29 |

- LOCKING DOOR HINGED RIGHT

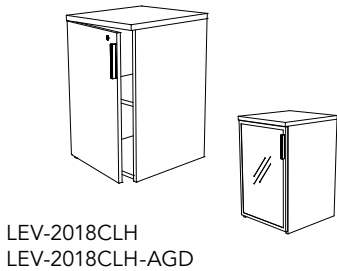

LEV-2018CLH  
LEV-2018CLH-AGD

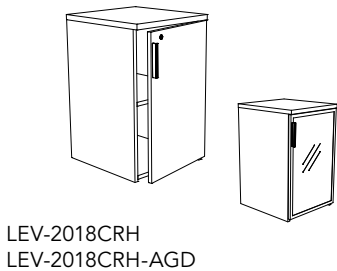

LEV-2018CRH  
LEV-2018CRH-AGD

**SINGLE DOOR CABINET W/ STORAGE RISER**

20" DEEP W/ 1 ADJUSTABLE SHELF & LOCKING DOOR HINGED LEFT

|                  |              |              |    |   |       |       |    |
|------------------|--------------|--------------|----|---|-------|-------|----|
| LEV-2018CLH-SR29 | <b>\$823</b> | <i>\$277</i> | 59 | 6 | 17.75 | 19.75 | 29 |
| LEV-2024CLH-SR29 | <b>\$859</b> | <i>\$316</i> | 78 | 8 | 23.75 | 19.75 | 29 |

24" DEEP W/ 1 ADJUSTABLE SHELF & LOCKING DOOR HINGED LEFT

|                  |              |              |    |      |       |       |    |
|------------------|--------------|--------------|----|------|-------|-------|----|
| LEV-2418CLH-SR29 | <b>\$872</b> | <i>\$277</i> | 82 | 9    | 17.75 | 23.75 | 29 |
| LEV-2424CLH-SR29 | <b>\$884</b> | <i>\$316</i> | 92 | 10.5 | 23.75 | 23.75 | 29 |

- LOCKING DOOR HINGED LEFT

20" DEEP W/ 1 ADJUSTABLE SHELF & LOCKING DOOR HINGED RIGHT

|                  |              |              |    |   |       |       |    |
|------------------|--------------|--------------|----|---|-------|-------|----|
| LEV-2018CRH-SR29 | <b>\$823</b> | <i>\$277</i> | 59 | 6 | 17.75 | 19.75 | 29 |
| LEV-2024CRH-SR29 | <b>\$859</b> | <i>\$316</i> | 78 | 8 | 23.75 | 19.75 | 29 |

24" DEEP W/ 1 ADJUSTABLE SHELF & LOCKING DOOR HINGED RIGHT

|                  |              |              |    |      |       |       |    |
|------------------|--------------|--------------|----|------|-------|-------|----|
| LEV-2418CRH-SR29 | <b>\$872</b> | <i>\$277</i> | 82 | 9    | 17.75 | 23.75 | 29 |
| LEV-2424CRH-SR29 | <b>\$884</b> | <i>\$316</i> | 92 | 10.5 | 23.75 | 23.75 | 29 |

- LOCKING DOOR HINGED RIGHT

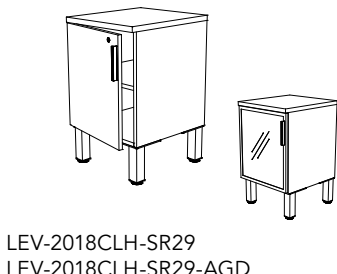

LEV-2018CLH-SR29  
LEV-2018CLH-SR29-AGD

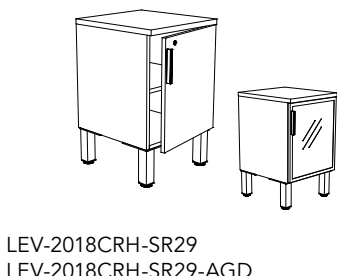

LEV-2018CRH-SR29  
LEV-2018CRH-SR29-AGD



| MODEL | LIST     | *AGD | WEIGHT | CUBE            | W  | D  | H  |
|-------|----------|------|--------|-----------------|----|----|----|
|       | UPCHARGE |      | LBS    | FT <sup>3</sup> | IN | IN | IN |

**22" HIGH SINGLE DOOR CABINET**

20" DEEP W/ 1 ADJUSTABLE SHELF & LOCKING DOOR HINGED LEFT

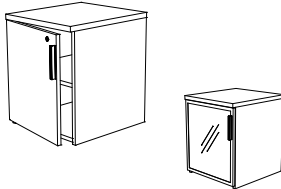

LEV-2018CLH-22  
LEV-2018CLH-22-AGD

|                |              |              |           |          |              |              |           |
|----------------|--------------|--------------|-----------|----------|--------------|--------------|-----------|
| LEV-2018CLH-22 | <b>\$765</b> | <i>\$277</i> | <b>59</b> | <b>6</b> | <b>17.75</b> | <b>19.75</b> | <b>22</b> |
| LEV-2024CLH-22 | <b>\$801</b> | <i>\$316</i> | <b>78</b> | <b>8</b> | <b>23.75</b> | <b>19.75</b> | <b>22</b> |

24" DEEP W/ 1 ADJUSTABLE SHELF & LOCKING DOOR HINGED LEFT

|                |              |              |           |             |              |              |           |
|----------------|--------------|--------------|-----------|-------------|--------------|--------------|-----------|
| LEV-2418CLH-22 | <b>\$814</b> | <i>\$277</i> | <b>82</b> | <b>9</b>    | <b>17.75</b> | <b>23.75</b> | <b>22</b> |
| LEV-2424CLH-22 | <b>\$826</b> | <i>\$316</i> | <b>92</b> | <b>10.5</b> | <b>23.75</b> | <b>23.75</b> | <b>22</b> |

- LOCKING DOOR HINGED LEFT

20" DEEP W/ 1 ADJUSTABLE SHELF & LOCKING DOOR HINGED RIGHT

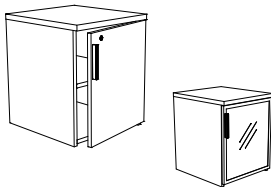

LEV-2018CRH-22  
LEV-2018CRH-22-AGD

|                |              |              |           |          |              |              |           |
|----------------|--------------|--------------|-----------|----------|--------------|--------------|-----------|
| LEV-2018CRH-22 | <b>\$765</b> | <i>\$277</i> | <b>59</b> | <b>6</b> | <b>17.75</b> | <b>19.75</b> | <b>22</b> |
| LEV-2024CRH-22 | <b>\$801</b> | <i>\$316</i> | <b>78</b> | <b>8</b> | <b>23.75</b> | <b>19.75</b> | <b>22</b> |

24" DEEP W/ 1 ADJUSTABLE SHELF & LOCKING DOOR HINGED RIGHT

|                |              |              |           |             |              |              |           |
|----------------|--------------|--------------|-----------|-------------|--------------|--------------|-----------|
| LEV-2418CRH-22 | <b>\$814</b> | <i>\$277</i> | <b>82</b> | <b>9</b>    | <b>17.75</b> | <b>23.75</b> | <b>22</b> |
| LEV-2424CRH-22 | <b>\$826</b> | <i>\$316</i> | <b>92</b> | <b>10.5</b> | <b>23.75</b> | <b>23.75</b> | <b>22</b> |

- LOCKING DOOR HINGED RIGHT

**SINGLE DOOR CABINET - NO TOP**

20" DEEP W/ 1 ADJUSTABLE SHELF & HINGED LEFT

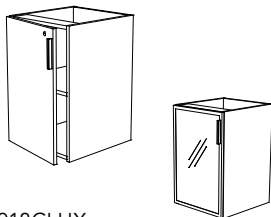

LEV-2018CLHX  
LEV-2018CLHX-AGD

|              |              |              |           |          |              |              |           |
|--------------|--------------|--------------|-----------|----------|--------------|--------------|-----------|
| LEV-2018CLHX | <b>\$735</b> | <i>\$288</i> | <b>49</b> | <b>6</b> | <b>17.75</b> | <b>19.75</b> | <b>28</b> |
| LEV-2024CLHX | <b>\$771</b> | <i>\$330</i> | <b>65</b> | <b>8</b> | <b>23.75</b> | <b>19.75</b> | <b>28</b> |

- LOCKING DOOR HINGED LEFT
- FITS UNDER WORK SURFACE

20" DEEP W/ 1 ADJUSTABLE SHELF & HINGED RIGHT

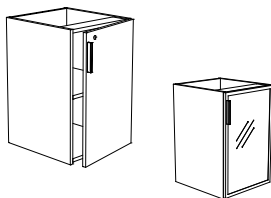

LEV-2018CRHX  
LEV-2018CRHX-AGD

|              |              |              |           |          |              |              |           |
|--------------|--------------|--------------|-----------|----------|--------------|--------------|-----------|
| LEV-2018CRHX | <b>\$735</b> | <i>\$288</i> | <b>49</b> | <b>6</b> | <b>17.75</b> | <b>19.75</b> | <b>28</b> |
| LEV-2024CRHX | <b>\$771</b> | <i>\$330</i> | <b>65</b> | <b>8</b> | <b>23.75</b> | <b>19.75</b> | <b>28</b> |

- LOCKING DOOR HINGED RIGHT
- FITS UNDER WORK SURFACE

**SINGLE DOOR CABINET - NO TOP W/ STORAGE RISER**

20" DEEP W/ 1 ADJUSTABLE SHELF & HINGED LEFT

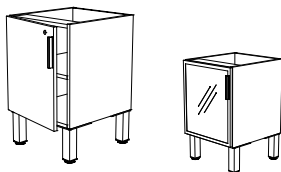

LEV-2018CLHX-SR28  
LEV-2018CLHX-SR28-AGD

|                   |              |              |           |          |              |              |           |
|-------------------|--------------|--------------|-----------|----------|--------------|--------------|-----------|
| LEV-2018CLHX-SR28 | <b>\$774</b> | <i>\$277</i> | <b>49</b> | <b>6</b> | <b>17.75</b> | <b>19.75</b> | <b>28</b> |
| LEV-2024CLHX-SR28 | <b>\$810</b> | <i>\$316</i> | <b>65</b> | <b>8</b> | <b>23.75</b> | <b>19.75</b> | <b>28</b> |

- LOCKING DOOR HINGED LEFT
- FITS UNDER WORK SURFACE

| MODEL | LIST     | *AGD | WEIGHT | CUBE            | W  | D  | H  |
|-------|----------|------|--------|-----------------|----|----|----|
|       | UPCHARGE |      | LBS    | FT <sup>3</sup> | IN | IN | IN |

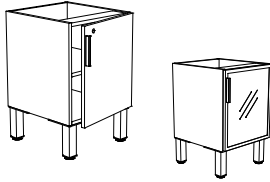

LEV-2018CRHX-SR28  
LEV-2018CRHX-SR28-AGD

20" DEEP W/ 1 ADJUSTABLE SHELF & HINGED RIGHT

|                          |              |              |           |          |              |              |           |
|--------------------------|--------------|--------------|-----------|----------|--------------|--------------|-----------|
| <b>LEV-2018CRHX-SR28</b> | <b>\$774</b> | <i>\$277</i> | <b>49</b> | <b>6</b> | <b>17.75</b> | <b>19.75</b> | <b>28</b> |
| <b>LEV-2024CRHX-SR28</b> | <b>\$810</b> | <i>\$316</i> | <b>65</b> | <b>8</b> | <b>23.75</b> | <b>19.75</b> | <b>28</b> |

- LOCKING DOOR HINGED RIGHT
- FITS UNDER WORK SURFACE

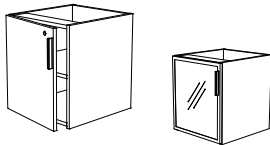

LEV-2018CLHX-21  
LEV-2018CLHX-21-AGD

**21" HIGH SINGLE DOOR CABINET - NO TOP**

20" DEEP W/ 1 ADJUSTABLE SHELF & HINGED LEFT

|                        |              |              |           |          |              |              |           |
|------------------------|--------------|--------------|-----------|----------|--------------|--------------|-----------|
| <b>LEV-2018CLHX-21</b> | <b>\$716</b> | <i>\$277</i> | <b>49</b> | <b>6</b> | <b>17.75</b> | <b>19.75</b> | <b>21</b> |
| <b>LEV-2024CLHX-21</b> | <b>\$752</b> | <i>\$316</i> | <b>65</b> | <b>8</b> | <b>23.75</b> | <b>19.75</b> | <b>21</b> |

- LOCKING DOOR HINGED LEFT
- FITS UNDER WORK SURFACE

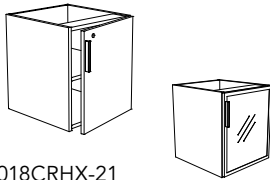

LEV-2018CRHX-21  
LEV-2018CRHX-21-AGD

20" DEEP W/ 1 ADJUSTABLE SHELF & HINGED RIGHT

|                        |              |              |           |          |              |              |           |
|------------------------|--------------|--------------|-----------|----------|--------------|--------------|-----------|
| <b>LEV-2018CRHX-21</b> | <b>\$716</b> | <i>\$277</i> | <b>49</b> | <b>6</b> | <b>17.75</b> | <b>19.75</b> | <b>21</b> |
| <b>LEV-2024CRHX-21</b> | <b>\$752</b> | <i>\$316</i> | <b>65</b> | <b>8</b> | <b>23.75</b> | <b>19.75</b> | <b>21</b> |

- LOCKING DOOR HINGED RIGHT
- FITS UNDER WORK SURFACE

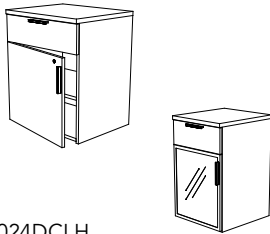

LEV-2024DCLH  
LEV-2024DCLH-AGD

**CABINET - DRAWER OVER SINGLE DOOR**

20" DEEP W/ 1 ADJUSTABLE SHELF & LOCKING DOOR HINGED LEFT

|                     |                |              |           |          |              |              |           |
|---------------------|----------------|--------------|-----------|----------|--------------|--------------|-----------|
| <b>LEV-2018DCLH</b> | <b>\$1,010</b> | <i>\$277</i> | <b>64</b> | <b>6</b> | <b>17.75</b> | <b>19.75</b> | <b>29</b> |
| <b>LEV-2024DCLH</b> | <b>\$1,045</b> | <i>\$296</i> | <b>82</b> | <b>8</b> | <b>23.75</b> | <b>19.75</b> | <b>29</b> |

24" DEEP W/ 1 ADJUSTABLE SHELF & LOCKING DOOR HINGED LEFT

|                     |                |              |           |             |              |              |           |
|---------------------|----------------|--------------|-----------|-------------|--------------|--------------|-----------|
| <b>LEV-2418DCLH</b> | <b>\$1,030</b> | <i>\$277</i> | <b>86</b> | <b>9</b>    | <b>17.75</b> | <b>23.75</b> | <b>29</b> |
| <b>LEV-2424DCLH</b> | <b>\$1,079</b> | <i>\$296</i> | <b>95</b> | <b>10.5</b> | <b>23.75</b> | <b>23.75</b> | <b>29</b> |

- LOCKING DOOR HINGED LEFT
- OPTIONAL LOCK ON DRAWER SEE [LEV-6](#)

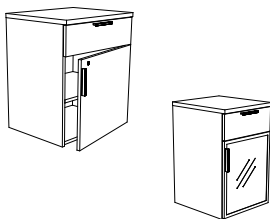

LEV-2024DCRH  
LEV-2024DCRH-AGD

20" DEEP W/ 1 ADJUSTABLE SHELF & LOCKING DOOR HINGED RIGHT

|                     |                |              |           |          |              |              |           |
|---------------------|----------------|--------------|-----------|----------|--------------|--------------|-----------|
| <b>LEV-2018DCRH</b> | <b>\$1,010</b> | <i>\$277</i> | <b>64</b> | <b>6</b> | <b>17.75</b> | <b>19.75</b> | <b>29</b> |
| <b>LEV-2024DCRH</b> | <b>\$1,045</b> | <i>\$296</i> | <b>82</b> | <b>8</b> | <b>23.75</b> | <b>19.75</b> | <b>29</b> |

24" DEEP W/ 1 ADJUSTABLE SHELF & LOCKING DOOR HINGED RIGHT

|                     |                |              |           |             |              |              |           |
|---------------------|----------------|--------------|-----------|-------------|--------------|--------------|-----------|
| <b>LEV-2418DCRH</b> | <b>\$1,030</b> | <i>\$277</i> | <b>86</b> | <b>9</b>    | <b>17.75</b> | <b>23.75</b> | <b>29</b> |
| <b>LEV-2424DCRH</b> | <b>\$1,079</b> | <i>\$296</i> | <b>95</b> | <b>10.5</b> | <b>23.75</b> | <b>23.75</b> | <b>29</b> |

- LOCKING DOOR HINGED RIGHT
- OPTIONAL LOCK ON DRAWER SEE [LEV-6](#)

| MODEL | LIST | *AGD     | WEIGHT | CUBE            | W  | D  | H  |
|-------|------|----------|--------|-----------------|----|----|----|
|       |      | UPCHARGE | LBS    | FT <sup>3</sup> | IN | IN | IN |

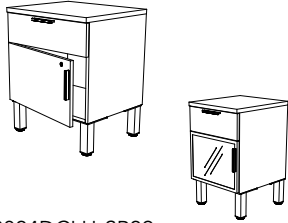

LEV-2024DCLH-SR29  
LEV-2024DCLH-SR29-AGD

**DRAWER OVER SINGLE DOOR CABINET W/ STORAGE RISER**

20" DEEP W/ 1 ADJUSTABLE SHELF & LOCKING DOOR HINGED LEFT

|                   |                |              |    |   |       |       |    |
|-------------------|----------------|--------------|----|---|-------|-------|----|
| LEV-2018DCLH-SR29 | <b>\$1,052</b> | <i>\$264</i> | 64 | 6 | 17.75 | 19.75 | 29 |
| LEV-2024DCLH-SR29 | <b>\$1,070</b> | <i>\$282</i> | 82 | 8 | 23.75 | 19.75 | 29 |

24" DEEP W/ 1 ADJUSTABLE SHELF & LOCKING DOOR HINGED LEFT

|                   |                |              |    |      |       |       |    |
|-------------------|----------------|--------------|----|------|-------|-------|----|
| LEV-2418DCLH-SR29 | <b>\$1,070</b> | <i>\$264</i> | 86 | 9    | 17.75 | 23.75 | 29 |
| LEV-2424DCLH-SR29 | <b>\$1,119</b> | <i>\$282</i> | 95 | 10.5 | 23.75 | 23.75 | 29 |

- LOCKING DOOR HINGED LEFT
- OPTIONAL LOCK ON DRAWER SEE [LEV-6](#)

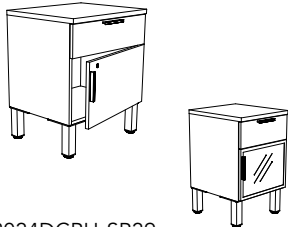

LEV-2024DCRH-SR29  
LEV-2024DCRH-SR29-AGD

20" DEEP W/ 1 ADJUSTABLE SHELF & LOCKING DOOR HINGED RIGHT

|                   |                |              |    |   |       |       |    |
|-------------------|----------------|--------------|----|---|-------|-------|----|
| LEV-2018DCRH-SR29 | <b>\$1,052</b> | <i>\$264</i> | 64 | 6 | 17.75 | 19.75 | 29 |
| LEV-2024DCRH-SR29 | <b>\$1,070</b> | <i>\$282</i> | 82 | 8 | 23.75 | 19.75 | 29 |

24" DEEP W/ 1 ADJUSTABLE SHELF & LOCKING DOOR HINGED RIGHT

|                   |                |              |    |      |       |       |    |
|-------------------|----------------|--------------|----|------|-------|-------|----|
| LEV-2418DCRH-SR29 | <b>\$1,070</b> | <i>\$264</i> | 86 | 9    | 17.75 | 23.75 | 29 |
| LEV-2424DCRH-SR29 | <b>\$1,119</b> | <i>\$282</i> | 95 | 10.5 | 23.75 | 23.75 | 29 |

- LOCKING DOOR HINGED RIGHT
- OPTIONAL LOCK ON DRAWER SEE [LEV-6](#)

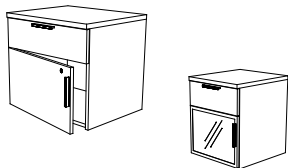

LEV-2024DCLH-22  
LEV-2024DCLH-22-AGD

**22" HIGH CABINET - DRAWER OVER SINGLE DOOR**

20" DEEP W/ 1 ADJUSTABLE SHELF & LOCKING DOOR HINGED LEFT

|                 |                |              |    |   |       |       |    |
|-----------------|----------------|--------------|----|---|-------|-------|----|
| LEV-2018DCLH-22 | <b>\$994</b>   | <i>\$264</i> | 64 | 6 | 17.75 | 19.75 | 22 |
| LEV-2024DCLH-22 | <b>\$1,012</b> | <i>\$282</i> | 78 | 8 | 23.75 | 19.75 | 22 |

24" DEEP W/ 1 ADJUSTABLE SHELF & LOCKING DOOR HINGED LEFT

|                 |                |              |    |      |       |       |    |
|-----------------|----------------|--------------|----|------|-------|-------|----|
| LEV-2418DCLH-22 | <b>\$1,012</b> | <i>\$264</i> | 86 | 9    | 17.75 | 23.75 | 22 |
| LEV-2424DCLH-22 | <b>\$1,061</b> | <i>\$282</i> | 95 | 10.5 | 23.75 | 23.75 | 22 |

- LOCKING DOOR HINGED LEFT
- OPTIONAL LOCK ON DRAWER SEE [LEV-6](#)

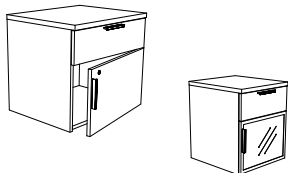

LEV-2024DCRH-22  
LEV-2024DCRH-22-AGD

20" DEEP W/ 1 ADJUSTABLE SHELF & LOCKING DOOR HINGED RIGHT

|                 |                |              |    |   |       |       |    |
|-----------------|----------------|--------------|----|---|-------|-------|----|
| LEV-2018DCRH-22 | <b>\$994</b>   | <i>\$264</i> | 64 | 6 | 17.75 | 19.75 | 22 |
| LEV-2024DCRH-22 | <b>\$1,012</b> | <i>\$282</i> | 82 | 8 | 23.75 | 19.75 | 22 |

24" DEEP W/ 1 ADJUSTABLE SHELF & LOCKING DOOR HINGED RIGHT

|                 |                |              |    |      |       |       |    |
|-----------------|----------------|--------------|----|------|-------|-------|----|
| LEV-2418DCRH-22 | <b>\$1,012</b> | <i>\$264</i> | 86 | 9    | 17.75 | 23.75 | 22 |
| LEV-2424DCRH-22 | <b>\$1,061</b> | <i>\$282</i> | 95 | 10.5 | 23.75 | 23.75 | 22 |

- LOCKING DOOR HINGED RIGHT
- OPTIONAL LOCK ON DRAWER SEE [LEV-6](#)

| MODEL | LIST     | *AGD | WEIGHT | CUBE            | W  | D  | H  |
|-------|----------|------|--------|-----------------|----|----|----|
|       | UPCHARGE |      | LBS    | FT <sup>3</sup> | IN | IN | IN |

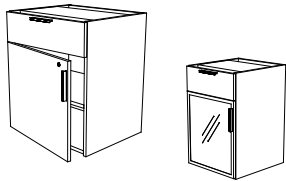

LEV-2024DCLHX  
LEV-2024DCLHX-AGD

**CABINET - DRAWER OVER DOOR - NO TOP**

20" DEEP W/ 1 ADJUSTABLE SHELF & LOCKING DOOR HINGED LEFT

|               |       |       |    |   |       |       |    |
|---------------|-------|-------|----|---|-------|-------|----|
| LEV-2018DCLHX | \$960 | \$277 | 54 | 6 | 17.75 | 19.75 | 28 |
| LEV-2024DCLHX | \$997 | \$296 | 70 | 8 | 23.75 | 19.75 | 28 |

- LOCKING DOOR HINGED LEFT
- FITS UNDER WORK SURFACE
- OPTIONAL LOCK ON DRAWER SEE [LEV-6](#)

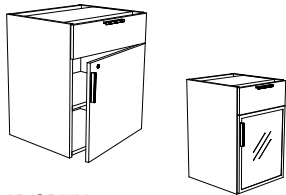

LEV-2024DCRHX  
LEV-2024DCRHX-AGD

20" DEEP W/ 1 ADJUSTABLE SHELF & LOCKING DOOR HINGED RIGHT

|               |       |       |    |   |       |       |    |
|---------------|-------|-------|----|---|-------|-------|----|
| LEV-2018DCRHX | \$960 | \$277 | 54 | 6 | 17.75 | 19.75 | 28 |
| LEV-2024DCRHX | \$997 | \$296 | 70 | 8 | 23.75 | 19.75 | 28 |

- LOCKING DOOR HINGED RIGHT
- FITS UNDER WORK SURFACE
- OPTIONAL LOCK ON DRAWER SEE [LEV-6](#)

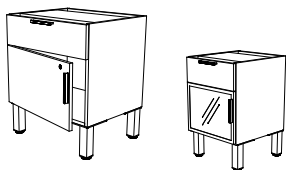

LEV-2024DCLHX-SR28  
LEV-2024DCLHX-SR28-AGD

**DRAWER OVER DOOR CABINET - NO TOP W/ STORAGE RISER**

20" DEEP W/ 1 ADJUSTABLE SHELF & LOCKING DOOR HINGED LEFT

|                    |         |       |    |   |       |       |    |
|--------------------|---------|-------|----|---|-------|-------|----|
| LEV-2018DCLHX-SR28 | \$1,001 | \$264 | 54 | 6 | 17.75 | 19.75 | 28 |
| LEV-2024DCLHX-SR28 | \$1,020 | \$282 | 70 | 8 | 23.75 | 19.75 | 28 |

- LOCKING DOOR HINGED LEFT
- FITS UNDER WORK SURFACE
- OPTIONAL LOCK ON DRAWER SEE [LEV-6](#)

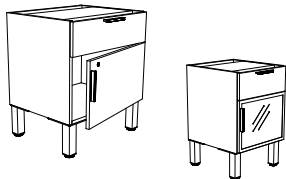

LEV-2024DCRHX-SR28  
LEV-2024DCRHX-SR28-AGD

20" DEEP W/ 1 ADJUSTABLE SHELF & LOCKING DOOR HINGED RIGHT

|                    |         |       |    |   |       |       |    |
|--------------------|---------|-------|----|---|-------|-------|----|
| LEV-2018DCRHX-SR28 | \$1,001 | \$264 | 54 | 6 | 17.75 | 19.75 | 28 |
| LEV-2024DCRHX-SR28 | \$1,020 | \$282 | 70 | 8 | 23.75 | 19.75 | 28 |

- LOCKING DOOR HINGED RIGHT
- FITS UNDER WORK SURFACE
- OPTIONAL LOCK ON DRAWER SEE [LEV-6](#)

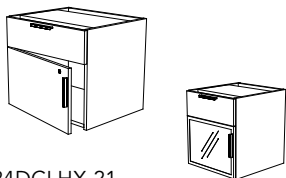

LEV-2024DCLHX-21  
LEV-2024DCLHX-21-AGD

**21" HIGH DRAWER OVER DOOR CABINET - NO TOP**

20" DEEP W/ 1 ADJUSTABLE SHELF & LOCKING DOOR HINGED LEFT

|                  |       |       |    |   |       |       |    |
|------------------|-------|-------|----|---|-------|-------|----|
| LEV-2018DCLHX-21 | \$943 | \$264 | 54 | 6 | 17.75 | 19.75 | 21 |
| LEV-2024DCLHX-21 | \$962 | \$282 | 70 | 8 | 23.75 | 19.75 | 21 |

- LOCKING DOOR HINGED LEFT
- FITS UNDER WORK SURFACE
- OPTIONAL LOCK ON DRAWER SEE [LEV-6](#)

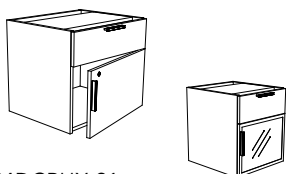

LEV-2024DCRHX-21  
LEV-2024DCRHX-21-AGD

20" DEEP W/ 1 ADJUSTABLE SHELF & LOCKING DOOR HINGED RIGHT

|                  |       |       |    |   |       |       |    |
|------------------|-------|-------|----|---|-------|-------|----|
| LEV-2018DCRHX-21 | \$943 | \$264 | 54 | 6 | 17.75 | 19.75 | 21 |
| LEV-2024DCRHX-21 | \$962 | \$282 | 70 | 8 | 23.75 | 19.75 | 21 |

- LOCKING DOOR HINGED RIGHT
- FITS UNDER WORK SURFACE
- OPTIONAL LOCK ON DRAWER SEE [LEV-6](#)

| MODEL | LIST     | *AGD | WEIGHT | CUBE            | W  | D  | H  |
|-------|----------|------|--------|-----------------|----|----|----|
|       | UPCHARGE |      | LBS    | FT <sup>3</sup> | IN | IN | IN |

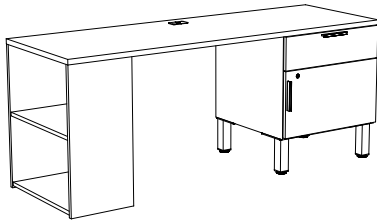

| <b>EXAMPLE 1</b>   |  |
|--------------------|--|
| LEV-2472RET-COX    | 24" DEEP RECTANGULAR BULLET TOP DESK W/ OPEN CABINET |
| LEV-2024DCRHX-SR28 | DRAWER OVER DOOR CABINET - NO TOP W/ STORAGE RISER   |

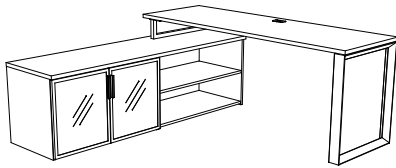

| <b>EXAMPLE 2</b>  |  |
|-------------------|--|
| LEV-TR2472-LOOP   | TIERED RECTANGULAR BULLET RETURN                   |
| LEV-2036COX-21    | OPEN CABINET - NO TOP                              |
| LEV-2036CX-21-AGD | 21" HIGH DOUBLE DOOR CABINET - NO TOP W/ AGD DOORS |
| LEV-2072FC        | FILE CABINET TOP                                   |

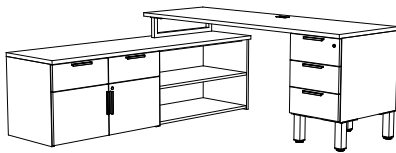

| <b>EXAMPLE 3</b> |   |
|------------------|---|
| LEV-TR2472BR     | 24" DEEP TIERED BRIDGE                          |
| LEV-2036COX-21   | OPEN CABINET - NO TOP                           |
| LEV-2036DCX-21   | 21" HIGH DRAWERS OVER DOORS CABINET - NO TOP    |
| LEV-2072FC       | FILE CABINET TOP                                |
| LEV-24FPUX-SR28  | FREESTANDING PEDESTAL - NO TOP W/ STORAGE RISER |

**OPEN CABINET STORAGE**

| MODEL | LIST | WEIGHT | CUBE            | W  | D  | H  |
|-------|------|--------|-----------------|----|----|----|
|       | IN   | LBS    | FT <sup>3</sup> | IN | IN | IN |

**OPEN CABINET**

20" DEEP W/ 1 ADJUSTABLE SHELF

|                   |              |           |              |             |              |           |
|-------------------|--------------|-----------|--------------|-------------|--------------|-----------|
| <b>LEV-2030CO</b> | <b>\$820</b> | <b>87</b> | <b>14</b>    | <b>29.5</b> | <b>19.75</b> | <b>29</b> |
| <b>LEV-2036CO</b> | <b>\$864</b> | <b>99</b> | <b>15.75</b> | <b>35.5</b> | <b>19.75</b> | <b>29</b> |

24" DEEP W/ 1 ADJUSTABLE SHELF

|                   |              |            |           |             |              |           |
|-------------------|--------------|------------|-----------|-------------|--------------|-----------|
| <b>LEV-2430CO</b> | <b>\$888</b> | <b>105</b> | <b>17</b> | <b>29.5</b> | <b>23.75</b> | <b>29</b> |
| <b>LEV-2436CO</b> | <b>\$921</b> | <b>119</b> | <b>19</b> | <b>35.5</b> | <b>23.75</b> | <b>29</b> |

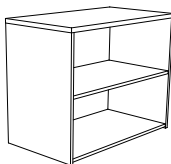

LEV-2036CO

| MODEL | LIST | WEIGHT | CUBE            | W  | D  | H  |
|-------|------|--------|-----------------|----|----|----|
|       |      | LBS    | FT <sup>3</sup> | IN | IN | IN |

**OPEN CABINET W/ STORAGE RISER**

20" DEEP W/ 1 ADJUSTABLE SHELF

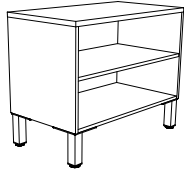

LEV-2036CO-SR29

|                                |              |            |              |             |              |           |
|--------------------------------|--------------|------------|--------------|-------------|--------------|-----------|
| <b>LEV-2030CO-SR29</b>         | <b>\$859</b> | <b>87</b>  | <b>14</b>    | <b>29.5</b> | <b>19.75</b> | <b>29</b> |
| <b>LEV-2036CO-SR29</b>         | <b>\$903</b> | <b>99</b>  | <b>15.75</b> | <b>35.5</b> | <b>19.75</b> | <b>29</b> |
| 24" DEEP W/ 1 ADJUSTABLE SHELF |              |            |              |             |              |           |
| <b>LEV-2430CO-SR29</b>         | <b>\$914</b> | <b>105</b> | <b>17</b>    | <b>29.5</b> | <b>23.75</b> | <b>29</b> |
| <b>LEV-2436CO-SR29</b>         | <b>\$948</b> | <b>119</b> | <b>19</b>    | <b>35.5</b> | <b>23.75</b> | <b>29</b> |

**22' HIGH OPEN CABINET**

20" DEEP W/ 1 ADJUSTABLE SHELF

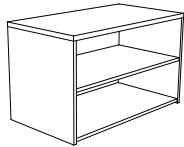

LEV-2036CO-22

|                                |              |            |              |             |              |           |
|--------------------------------|--------------|------------|--------------|-------------|--------------|-----------|
| <b>LEV-2030CO-22</b>           | <b>\$801</b> | <b>87</b>  | <b>14</b>    | <b>29.5</b> | <b>19.75</b> | <b>22</b> |
| <b>LEV-2036CO-22</b>           | <b>\$845</b> | <b>99</b>  | <b>15.75</b> | <b>35.5</b> | <b>19.75</b> | <b>22</b> |
| 24" DEEP W/ 1 ADJUSTABLE SHELF |              |            |              |             |              |           |
| <b>LEV-2430CO-22</b>           | <b>\$856</b> | <b>105</b> | <b>17</b>    | <b>29.5</b> | <b>23.75</b> | <b>22</b> |
| <b>LEV-2436CO-22</b>           | <b>\$890</b> | <b>119</b> | <b>19</b>    | <b>35.5</b> | <b>23.75</b> | <b>22</b> |

**OPEN CABINET - NO TOP**

20" DEEP W/ 1 ADJUSTABLE SHELF

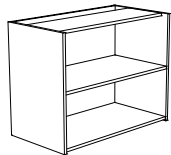

LEV-2036COX

|                    |              |            |           |             |              |           |
|--------------------|--------------|------------|-----------|-------------|--------------|-----------|
| <b>LEV-2030COX</b> | <b>\$792</b> | <b>100</b> | <b>13</b> | <b>29.5</b> | <b>19.75</b> | <b>28</b> |
| <b>LEV-2036COX</b> | <b>\$820</b> | <b>115</b> | <b>15</b> | <b>35.5</b> | <b>19.75</b> | <b>28</b> |

**OPEN CABINET - NO TOP W/ STORAGE RISERS**

20" DEEP W/ 1 ADJUSTABLE SHELF

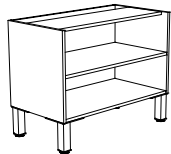

LEV-2036COX-SR28

|                         |              |            |           |             |              |           |
|-------------------------|--------------|------------|-----------|-------------|--------------|-----------|
| <b>LEV-2030COX-SR28</b> | <b>\$830</b> | <b>120</b> | <b>12</b> | <b>29.5</b> | <b>19.75</b> | <b>28</b> |
| <b>LEV-2036COX-SR28</b> | <b>\$859</b> | <b>115</b> | <b>15</b> | <b>35.5</b> | <b>19.75</b> | <b>28</b> |

**OPEN CABINET - NO TOP**

20" DEEP W/ 1 ADJUSTABLE SHELF

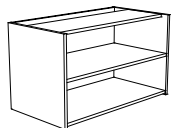

LEV-2036COX-21

|                       |              |            |           |             |              |           |
|-----------------------|--------------|------------|-----------|-------------|--------------|-----------|
| <b>LEV-2030COX-21</b> | <b>\$772</b> | <b>120</b> | <b>12</b> | <b>29.5</b> | <b>19.75</b> | <b>21</b> |
| <b>LEV-2036COX-21</b> | <b>\$801</b> | <b>115</b> | <b>15</b> | <b>35.5</b> | <b>19.75</b> | <b>21</b> |

| MODEL | LIST | WEIGHT | CUBE            | W  | D  | H  |
|-------|------|--------|-----------------|----|----|----|
|       |      | LBS    | FT <sup>3</sup> | IN | IN | IN |

**BOX/FILE OPEN CABINET W/ STORAGE RISERS**

20" DEEP 1 ADJUSTABLE SHELF

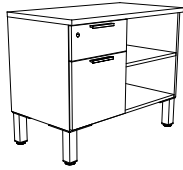

LEV-F2036CO-SR29

|                  |         |       |      |      |       |    |
|------------------|---------|-------|------|------|-------|----|
| LEV-F2030CO-SR29 | \$1,078 | 94    | 11.5 | 29.5 | 19.75 | 29 |
| LEV-F2036CO-SR29 | \$1,102 | 103.1 | 13.6 | 35.5 | 19.75 | 29 |

24" DEEP 1 ADJUSTABLE SHELF

|                  |         |       |      |      |       |    |
|------------------|---------|-------|------|------|-------|----|
| LEV-F2430CO-SR29 | \$1,113 | 104.4 | 13.6 | 29.5 | 23.75 | 29 |
| LEV-F2436CO-SR29 | \$1,222 | 115.  | 16.1 | 35.5 | 23.75 | 29 |

- LOCKING DRAWERS

**22" HIGH BOX/FILE OPEN CABINET**

20" DEEP 1 ADJUSTABLE SHELF



LEV-F2036CO-22

|                |         |      |      |      |       |    |
|----------------|---------|------|------|------|-------|----|
| LEV-F2030CO-22 | \$1,020 | 80.7 | 8.8  | 29.5 | 19.75 | 22 |
| LEV-F2036CO-22 | \$1,044 | 89.8 | 10.4 | 35.5 | 19.75 | 22 |

24" DEEP 1 ADJUSTABLE SHELF

|                |         |       |      |      |       |    |
|----------------|---------|-------|------|------|-------|----|
| LEV-F2430CO-22 | \$1,055 | 91.1  | 10.4 | 29.5 | 23.75 | 22 |
| LEV-F2436CO-22 | \$1,164 | 101.6 | 12.3 | 35.5 | 23.75 | 22 |

- LOCKING DRAWERS

**BOX/FILE OPEN CABINET W/ STORAGE RISERS - NO TOP**

20" DEEP 1 ADJUSTABLE SHELF



LEV-F2036COX-SR28

|                   |         |      |      |      |       |    |
|-------------------|---------|------|------|------|-------|----|
| LEV-F2030COX-SR28 | \$1,071 | 85.4 | 11.1 | 29.5 | 19.75 | 28 |
| LEV-F2036COX-SR28 | \$1,082 | 92.8 | 13.2 | 35.5 | 19.75 | 28 |

24" DEEP 1 ADJUSTABLE SHELF

|                   |         |       |      |      |       |    |
|-------------------|---------|-------|------|------|-------|----|
| LEV-F2430COX-SR28 | \$1,107 | 93.8  | 13.1 | 29.5 | 23.75 | 28 |
| LEV-F2436COX-SR28 | \$1,137 | 102.5 | 15.5 | 35.5 | 23.75 | 28 |

- LOCKING DRAWERS
- FITS UNDER WORK SURFACE

**21" HIGH BOX/FILE OPEN CABINET - NO TOP**

20" DEEP 1 ADJUSTABLE SHELF



LEV-F2036COX-21

|                 |         |      |     |      |       |    |
|-----------------|---------|------|-----|------|-------|----|
| LEV-F2030COX-21 | \$1,013 | 72.1 | 8.4 | 29.5 | 19.75 | 21 |
| LEV-F2036COX-21 | \$1,024 | 79.5 | 9.9 | 35.5 | 19.75 | 21 |

24" DEEP 1 ADJUSTABLE SHELF

|                 |         |      |      |      |       |    |
|-----------------|---------|------|------|------|-------|----|
| LEV-F2430COX-21 | \$1,049 | 80.5 | 9.9  | 29.5 | 23.75 | 21 |
| LEV-F2436COX-21 | \$1,079 | 89.2 | 11.7 | 35.5 | 23.75 | 21 |

- LOCKING DRAWERS
- FITS UNDER WORK SURFACE

| MODEL | LIST | WEIGHT | CUBE            | W  | D  | H  |
|-------|------|--------|-----------------|----|----|----|
|       |      | LBS    | FT <sup>3</sup> | IN | IN | IN |

**OPEN CABINET BOX/FILE W/ STORAGE RISERS**

20" DEEP 1 ADJUSTABLE SHELF

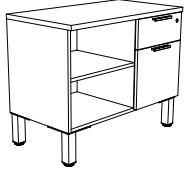

LEV-CO2036F-SR29

|                  |         |       |      |      |       |    |
|------------------|---------|-------|------|------|-------|----|
| LEV-CO2030F-SR29 | \$1,078 | 94    | 11.5 | 29.5 | 19.75 | 29 |
| LEV-CO2036F-SR29 | \$1,102 | 103.1 | 13.6 | 35.5 | 19.75 | 29 |

24" DEEP 1 ADJUSTABLE SHELF

|                  |         |       |      |      |       |    |
|------------------|---------|-------|------|------|-------|----|
| LEV-CO2430F-SR29 | \$1,113 | 104.4 | 13.6 | 29.5 | 23.75 | 29 |
| LEV-CO2436F-SR29 | \$1,222 | 115   | 16.1 | 35.5 | 23.75 | 29 |

- LOCKING DRAWERS

**22" HIGH OPEN CABINET BOX/FILE**

20" DEEP 1 ADJUSTABLE SHELF



LEV-CO2036F-22

|                |         |      |      |      |       |    |
|----------------|---------|------|------|------|-------|----|
| LEV-CO2030F-22 | \$1,020 | 80.7 | 8.8  | 29.5 | 19.75 | 22 |
| LEV-CO2036F-22 | \$1,044 | 89.8 | 10.4 | 35.5 | 19.75 | 22 |

24" DEEP 1 ADJUSTABLE SHELF

|                |         |       |      |      |       |    |
|----------------|---------|-------|------|------|-------|----|
| LEV-CO2430F-22 | \$1,055 | 91.1  | 10.4 | 29.5 | 23.75 | 22 |
| LEV-CO2436F-22 | \$1,164 | 101.6 | 12.3 | 35.5 | 23.75 | 22 |

- LOCKING DRAWERS

**OPEN CABINET BOX/FILE W/ STORAGE RISERS - NO TOP**

20" DEEP 1 ADJUSTABLE SHELF

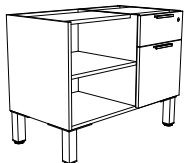

LEV-CO2036FX-SR28

|                   |         |      |      |      |       |    |
|-------------------|---------|------|------|------|-------|----|
| LEV-CO2030FX-SR28 | \$1,071 | 85.4 | 11.1 | 29.5 | 19.75 | 28 |
| LEV-CO2036FX-SR28 | \$1,082 | 92.8 | 13.2 | 35.5 | 19.75 | 28 |

24" DEEP 1 ADJUSTABLE SHELF

|                   |         |       |      |      |       |    |
|-------------------|---------|-------|------|------|-------|----|
| LEV-CO2430FX-SR28 | \$1,107 | 93.8  | 13.1 | 29.5 | 23.75 | 28 |
| LEV-CO2436FX-SR28 | \$1,137 | 102.5 | 15.5 | 35.5 | 23.75 | 28 |

- LOCKING DRAWERS
- FITS UNDER WORK SURFACE

**21" HIGH OPEN CABINET BOX/FILE - NO TOP**

20" DEEP 1 ADJUSTABLE SHELF

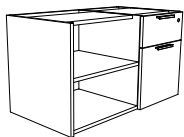

LEV-CO2036FX-21

|                 |         |      |     |      |       |    |
|-----------------|---------|------|-----|------|-------|----|
| LEV-CO2030FX-21 | \$1,013 | 72.1 | 8.4 | 29.5 | 19.75 | 21 |
| LEV-CO2036FX-21 | \$1,024 | 79.5 | 9.9 | 35.5 | 19.75 | 21 |

24" DEEP 1 ADJUSTABLE SHELF

|                 |         |      |      |      |       |    |
|-----------------|---------|------|------|------|-------|----|
| LEV-CO2430FX-21 | \$1,049 | 80.5 | 9.9  | 29.5 | 23.75 | 21 |
| LEV-CO2436FX-21 | \$1,079 | 89.2 | 11.7 | 35.5 | 23.75 | 21 |

- LOCKING DRAWERS
- FITS UNDER WORK SURFACE



| MODEL | LIST | WEIGHT | CUBE            | W  | D  | H  |
|-------|------|--------|-----------------|----|----|----|
|       |      | LBS    | FT <sup>3</sup> | IN | IN | IN |

**21" HIGH OPEN CABINET W/ RECESSED BACK- NO TOP**

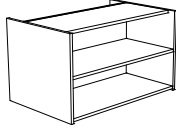

LEV-R2036COX-21

20" DEEP 1 ADJUSTABLE SHELF

|                 |              |      |     |      |       |    |
|-----------------|--------------|------|-----|------|-------|----|
| LEV-R2030COX-21 | <b>\$792</b> | 42.1 | 7.7 | 29.5 | 19.75 | 21 |
| LEV-R2036COX-21 | <b>\$820</b> | 47.9 | 9.2 | 35.5 | 19.75 | 21 |

24" DEEP 1 ADJUSTABLE SHELF

|                 |              |      |     |      |       |    |
|-----------------|--------------|------|-----|------|-------|----|
| LEV-R2430COX-21 | <b>\$852</b> | 52.7 | 9.2 | 29.5 | 23.75 | 21 |
| LEV-R2436COX-21 | <b>\$898</b> | 60.1 | 11  | 35.5 | 23.75 | 21 |

- DESIGNED FOR USE WITH NOTCHED COMMON TOPS . USE RECESS BACK UNITS TO "HIDE" SIT-STAND FOOT SEE [LEV-61](#) FOR EXAMPLES
- FITS UNDER WORK SURFACE

**OPEN CABINET W/ DIVIDER**

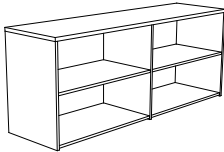

LEV-2072CO

20" DEEP W/ 2 ADJUSTABLE SHELVES.

|            |                |       |      |       |       |    |
|------------|----------------|-------|------|-------|-------|----|
| LEV-2060CO | <b>\$1,504</b> | 127.9 | 22.3 | 59.25 | 19.75 | 29 |
| LEV-2072CO | <b>\$1,604</b> | 148   | 26.6 | 71    | 19.75 | 29 |

24" DEEP W/ 2 ADJUSTABLE SHELVES.

|            |                |       |      |       |       |    |
|------------|----------------|-------|------|-------|-------|----|
| LEV-2460CO | <b>\$1,638</b> | 148.1 | 26.3 | 59.25 | 23.75 | 29 |
| LEV-2472CO | <b>\$1,682</b> | 171.1 | 31.4 | 71    | 23.75 | 29 |

**OPEN CABINET W/ DIVIDER & STORAGE RISER**

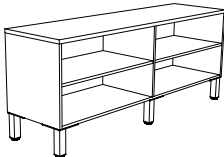

LEV-2072CO-SR29

20" DEEP W/ 2 ADJUSTABLE SHELVES.

|                 |                |       |      |       |       |    |
|-----------------|----------------|-------|------|-------|-------|----|
| LEV-2060CO-SR29 | <b>\$1,578</b> | 132.9 | 22.3 | 59.25 | 19.75 | 29 |
| LEV-2072CO-SR29 | <b>\$1,677</b> | 151.6 | 26.6 | 71    | 19.75 | 29 |

24" DEEP W/ 2 ADJUSTABLE SHELVES.

|                 |                |       |      |       |       |    |
|-----------------|----------------|-------|------|-------|-------|----|
| LEV-2460CO-SR29 | <b>\$1,699</b> | 151.7 | 26.3 | 59.25 | 23.75 | 29 |
| LEV-2472CO-SR29 | <b>\$1,742</b> | 173.2 | 31.4 | 71    | 23.75 | 29 |

**22" HIGH OPEN CABINET W/ DIVIDER**

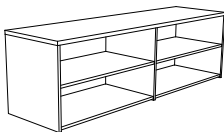

LEV-2072CO-22

20" DEEP W/ 2 ADJUSTABLE SHELVES.

|               |                |       |      |       |       |    |
|---------------|----------------|-------|------|-------|-------|----|
| LEV-2060CO-22 | <b>\$1,491</b> | 113.2 | 17   | 59.25 | 19.75 | 22 |
| LEV-2072CO-22 | <b>\$1,590</b> | 131.8 | 20.3 | 71    | 19.75 | 22 |

24" DEEP W/ 2 ADJUSTABLE SHELVES.

|               |                |       |      |       |       |    |
|---------------|----------------|-------|------|-------|-------|----|
| LEV-2460CO-22 | <b>\$1,612</b> | 131.9 | 20.1 | 59.25 | 23.75 | 22 |
| LEV-2472CO-22 | <b>\$1,655</b> | 153.4 | 23.9 | 71    | 23.75 | 22 |

**LEVELS SERIES**  
FILE CABINET TOPS | COMMON TOPS

| MODEL | LIST | WEIGHT | CUBE            | W  | D  | H  |
|-------|------|--------|-----------------|----|----|----|
|       |      | LBS    | FT <sup>3</sup> | IN | IN | IN |

**FILE CABINET TOP**

20" DEEP W/ MATCHING 2 MM EDGE BAND

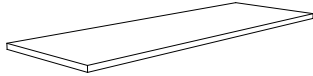

LEV-2060FC

|            |       |      |      |       |       |   |
|------------|-------|------|------|-------|-------|---|
| LEV-2018FC | \$172 | 8.7  | 0.41 | 17.75 | 19.75 | 1 |
| LEV-2024FC | \$177 | 11.6 | 0.5  | 23.75 | 19.75 | 1 |
| LEV-2030FC | \$189 | 14.4 | 0.7  | 29.5  | 19.75 | 1 |
| LEV-2036FC | \$204 | 18   | 0.77 | 35.5  | 19.75 | 1 |
| LEV-2042FC | \$225 | 20.3 | 0.88 | 41.5  | 19.75 | 1 |
| LEV-2048FC | \$246 | 23.1 | 1    | 47.25 | 19.75 | 1 |
| LEV-2054FC | \$265 | 25.8 | 1.11 | 53.25 | 19.75 | 1 |
| LEV-2060FC | \$337 | 30.5 | 1    | 59.25 | 19.75 | 1 |
| LEV-2066FC | \$353 | 33.4 | 1.1  | 65    | 19.75 | 1 |
| LEV-2072FC | \$361 | 36.5 | 1.1  | 71    | 19.75 | 1 |
| LEV-2078FC | \$387 | 39.6 | 1.2  | 77    | 19.75 | 1 |
| LEV-2084FC | \$424 | 40.4 | 1.7  | 82.75 | 19.75 | 1 |
| LEV-2090FC | \$461 | 45.6 | 1.4  | 88.75 | 19.75 | 1 |
| LEV-2096FC | \$518 | 48.6 | 1.5  | 94.5  | 19.75 | 1 |

- HARDWARE NOT INCLUDED

24" DEEP W/ MATCHING 2 MM EDGE BAND

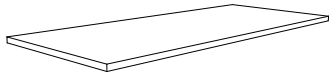

LEV-2460FC

|            |       |      |      |       |       |   |
|------------|-------|------|------|-------|-------|---|
| LEV-2418FC | \$181 | 11   | 0.51 | 17.75 | 23.75 | 1 |
| LEV-2424FC | \$188 | 14.7 | 0.65 | 23.75 | 23.75 | 1 |
| LEV-2430FC | \$198 | 18.2 | 0.8  | 29.5  | 23.75 | 1 |
| LEV-2436FC | \$214 | 22   | 0.94 | 35.5  | 23.75 | 1 |
| LEV-2442FC | \$235 | 25.7 | 1.09 | 41.5  | 23.75 | 1 |
| LEV-2448FC | \$257 | 29.2 | 1.23 | 47.25 | 23.75 | 1 |
| LEV-2454FC | \$276 | 32.7 | 1.36 | 53.25 | 23.75 | 1 |
| LEV-2460FC | \$348 | 36.6 | 1.1  | 59.25 | 23.75 | 1 |
| LEV-2466FC | \$363 | 40.2 | 1.2  | 65    | 23.75 | 1 |
| LEV-2472FC | \$371 | 43.9 | 1.4  | 71    | 23.75 | 1 |
| LEV-2478FC | \$398 | 47.6 | 1.5  | 77    | 23.75 | 1 |
| LEV-2484FC | \$436 | 51.2 | 2.09 | 82.75 | 23.75 | 1 |
| LEV-2490FC | \$471 | 54.9 | 1.7  | 88.75 | 23.75 | 1 |
| LEV-2496FC | \$528 | 58.4 | 1.8  | 94.5  | 23.75 | 1 |

- HARDWARE NOT INCLUDED



| EXAMPLE 1        |   |
|------------------|---|
| LEV-CO2036FX-21  | 21" HIGH OPEN CABINET BOX/FILE- NO TOP                      |
| LEV-2030WDCX-21  | 21" HIGH CABINET - WIDE DRAWER OVER 2 DOOR CABINET - NO TOP |
| LEV-2066FC       | FILE CABINET TOP  |
| LEV-2030CUSH-ESC | SEAT CUSHIONS FOR 21" HIGH CREDENZAS                        |

| MODEL | LIST | WEIGHT | CUBE            | W  | D  | H  |
|-------|------|--------|-----------------|----|----|----|
|       |      | LBS    | FT <sup>3</sup> | IN | IN | IN |

**NOTCHED CREDENZA TOP**

20" DEEP FOR NOTCHED CABINET TOP FOR HEIGHT-ADJUSTABLE DESKING

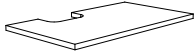

LEV-2036NTOP

|              |       |      |     |      |       |   |
|--------------|-------|------|-----|------|-------|---|
| LEV-2030NTOP | \$323 | 13.9 | 0.6 | 29.5 | 19.75 | 1 |
| LEV-2036NTOP | \$335 | 16.9 | 0.7 | 35.5 | 19.75 | 1 |

20" DEEP FOR NOTCHED COMMON TOP FOR HEIGHT-ADJUSTABLE DESKING

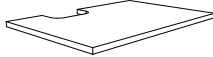

LEV-2436NTOP

|              |       |      |     |       |       |   |
|--------------|-------|------|-----|-------|-------|---|
| LEV-2060NTOP | \$382 | 28.9 | 1.1 | 59.25 | 19.75 | 1 |
| LEV-2066NTOP | \$406 | 31.9 | 1.3 | 65    | 19.75 | 1 |
| LEV-2072NTOP | \$457 | 35   | 1.4 | 71    | 19.75 | 1 |

24" DEEP FOR NOTCHED CABINET TOP FOR HEIGHT-ADJUSTABLE DESKING

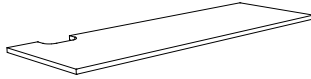

LEV-2072NTOP

|              |       |      |     |      |       |   |
|--------------|-------|------|-----|------|-------|---|
| LEV-2430NTOP | \$323 | 16.9 | 0.7 | 29.5 | 23.75 | 1 |
| LEV-2436NTOP | \$335 | 20.5 | 0.8 | 35.5 | 23.75 | 1 |

24" DEEP FOR NOTCHED COMMON TOP FOR HEIGHT-ADJUSTABLE DESKING



LEV-2472NTOP

|              |       |      |     |       |       |   |
|--------------|-------|------|-----|-------|-------|---|
| LEV-2460NTOP | \$452 | 34.9 | 1.4 | 59.25 | 23.75 | 1 |
| LEV-2466NTOP | \$474 | 38.5 | 1.5 | 65    | 23.75 | 1 |
| LEV-2472NTOP | \$497 | 42.1 | 1.6 | 71    | 23.75 | 1 |

- HARDWARE NOT INCLUDED
- TOPS ARE NON-HANDED

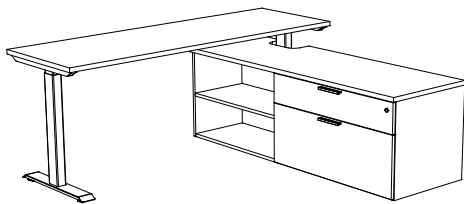

| EXAMPLE 1       |   |
|-----------------|---|
| LEV-2066NTOP    | 20" DEEP FOR NOTCHED COMMON TOP FOR HEIGHT-ADJUSTABLE DESKING |
| LEV-R2030COX-21 | 21" HIGH OPEN CABINET W/ RECESSED BACK- NO TOP                |
| LEV-2036WDCX-21 | 21 " HIGH DRAWERS OVER DOORS CABINET - NO TOP                 |
| LEV-2472-ATH-2L | ATHENA HEIGHT ADJUSTABLE DESK                                 |

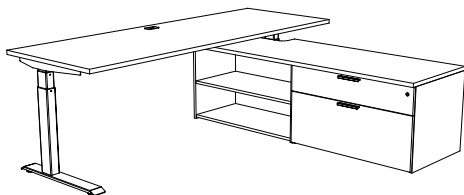

| EXAMPLE 2        |   |
|------------------|---|
| LEV-2472NTOP     | 24" DEEP FOR NOTCHED COMMON TOP FOR HEIGHT-ADJUSTABLE DESKING |
| LEV-R2436COX-21  | 21" HIGH OPEN CABINET W/ RECESSED BACK- NO TOP                |
| LEV-2436WDLFX-21 | 21" HIGH WIDE DRAWER OVER LATERAL FILE - NO TOP               |
| LEV-3084-CAL-2L  | CALYPSO HEIGHT ADJUSTABLE DESK                                |

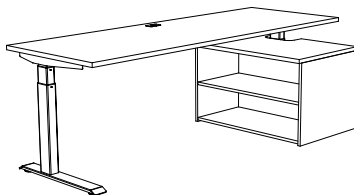

| EXAMPLE 3       |  |
|-----------------|--|
| LEV-2436NTOP    | 24" DEEP FOR NOTCHED CABINET TOP FOR HEIGHT-ADJUSTABLE DESKING |
| LEV-R2436COX-21 | 21" HIGH OPEN CABINET W/ RECESSED BACK- NO TOP                 |
| LEV-3084-CAL-2L | CALYPSO HEIGHT ADJUSTABLE DESK                                 |

# LEVELS SERIES

## MID-HEIGHT STORAGE RETURNS

| MODEL | LIST     | *AGD | WEIGHT | CUBE            | W  | D  | H  |
|-------|----------|------|--------|-----------------|----|----|----|
|       | UPCHARGE |      | LBS    | FT <sup>3</sup> | IN | IN | IN |

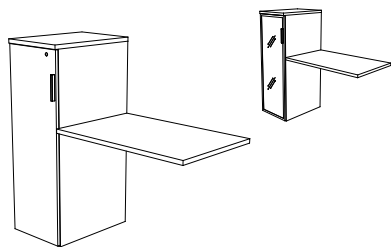

LEV-2436-4816MCL-L-AGD  
LEV-2436-4816MCL-L

### MID-HEIGHT SINGLE DOOR CLOSET CABINET & 24" RETURN

LEFT DESK, HINGED LEFT

|                    |         |       |       |      |       |       |       |
|--------------------|---------|-------|-------|------|-------|-------|-------|
| LEV-2424-4816MCL-L | \$1,195 | \$442 | 87.4  | 12.4 | 39.5  | 23.75 | 47.75 |
| LEV-2430-4816MCL-L | \$1,214 | \$442 | 90.9  | 12.5 | 45.5  | 23.75 | 47.75 |
| LEV-2436-4816MCL-L | \$1,231 | \$442 | 94.3  | 12.6 | 51.25 | 23.75 | 47.75 |
| LEV-2442-4816MCL-L | \$1,250 | \$442 | 97.7  | 12.8 | 57.25 | 23.75 | 47.75 |
| LEV-2448-4816MCL-L | \$1,260 | \$442 | 101.2 | 12.9 | 63    | 23.75 | 47.75 |

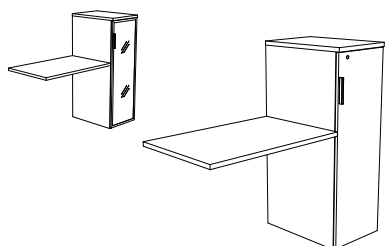

LEV-2436-4816MCL-R-AGD  
LEV-2436-4816MCL-R

RIGHT DESK, HINGED RIGHT

|                    |         |       |       |      |       |       |       |
|--------------------|---------|-------|-------|------|-------|-------|-------|
| LEV-2424-4816MCL-R | \$1,195 | \$442 | 87.4  | 12.4 | 39.5  | 23.75 | 47.75 |
| LEV-2430-4816MCL-R | \$1,214 | \$442 | 90.9  | 12.5 | 45.5  | 23.75 | 47.75 |
| LEV-2436-4816MCL-R | \$1,231 | \$442 | 94.3  | 12.6 | 51.25 | 23.75 | 47.75 |
| LEV-2442-4816MCL-R | \$1,250 | \$442 | 97.7  | 12.8 | 57.25 | 23.75 | 47.75 |
| LEV-2448-4816MCL-R | \$1,260 | \$442 | 101.2 | 12.9 | 63    | 23.75 | 47.75 |

- INCLUDES COAT HOOKS . OPTIONAL BOOT SHELF AVAILABLE
- TO ADD BOOTSHELF, ADD **-BS** TO SKU. UP-CHARGES APPLY SEE [LEV-5](#)

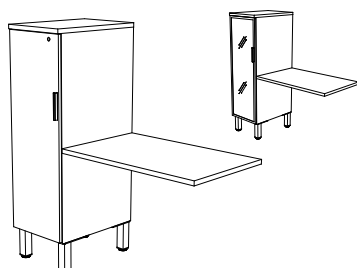

LEV-2436-5516MCL-L-SR-AGD  
LEV-2436-5516MCL-L-SR

### MID-HEIGHT SINGLE DOOR CLOSET CABINET W/ STORAGE RISER & 24" RETURN

LEFT DESK, HINGED LEFT

|                       |         |       |       |      |       |       |       |
|-----------------------|---------|-------|-------|------|-------|-------|-------|
| LEV-2424-5516MCL-L-SR | \$1,253 | \$442 | 106.2 | 33.5 | 39.5  | 23.75 | 54.75 |
| LEV-2430-5516MCL-L-SR | \$1,272 | \$442 | 109.6 | 38.3 | 45.5  | 23.75 | 54.75 |
| LEV-2436-5516MCL-L-SR | \$1,289 | \$442 | 113   | 43.1 | 51.25 | 23.75 | 54.75 |
| LEV-2442-5516MCL-L-SR | \$1,308 | \$442 | 116.5 | 47.8 | 57.25 | 23.75 | 54.75 |
| LEV-2448-5516MCL-L-SR | \$1,318 | \$442 | 119.9 | 52.6 | 63    | 23.75 | 54.75 |

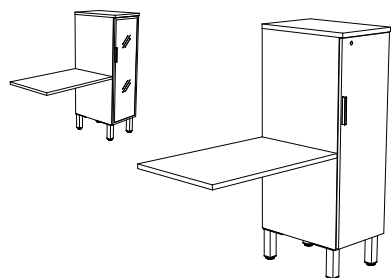

LEV-2436-5516MCL-R-SR-AGD  
LEV-2436-5516MCL-R-SR

RIGHT DESK, HINGED RIGHT

|                       |         |       |       |      |       |       |       |
|-----------------------|---------|-------|-------|------|-------|-------|-------|
| LEV-2424-5516MCL-R-SR | \$1,253 | \$442 | 106.2 | 33.5 | 39.5  | 23.75 | 54.75 |
| LEV-2430-5516MCL-R-SR | \$1,272 | \$442 | 109.6 | 38.3 | 45.5  | 23.75 | 54.75 |
| LEV-2436-5516MCL-R-SR | \$1,289 | \$442 | 113   | 43.1 | 51.25 | 23.75 | 54.75 |
| LEV-2442-5516MCL-R-SR | \$1,308 | \$442 | 116.5 | 47.8 | 57.25 | 23.75 | 54.75 |
| LEV-2448-5516MCL-R-SR | \$1,318 | \$442 | 119.9 | 52.6 | 63    | 23.75 | 54.75 |

- INCLUDES COAT HOOKS . OPTIONAL BOOT SHELF AVAILABLE
- TO ADD BOOTSHELF, ADD **-BS** TO SKU. UP-CHARGES APPLY SEE [LEV-5](#)

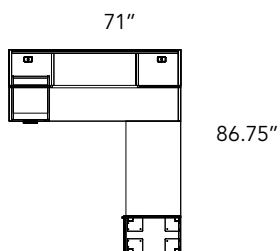
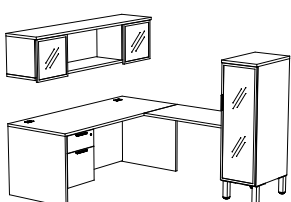

| EXAMPLE               |   |
|-----------------------|---|
| LEV-2442-5516MCL-R-SR | MID-HEIGHT SINGLE DOOR CLOSET CABINET W/ STORAGE RISER & 42" RETURN |
| LEV-3072CT-A          | 30" CONNECTOR TOP   |
| LEV-1772OSHD2-AGD     | OVERHEAD STORAGE - W/ 2 DOORS - AGD                                 |
| LEV-HPF               | HANGING PEDESTAL  |

| MODEL | LIST | *AGD<br>UPCHARGE | WEIGHT<br>LBS | CUBE<br>FT <sup>3</sup> | W<br>IN | D<br>IN | H<br>IN |
|-------|------|------------------|---------------|-------------------------|---------|---------|---------|
|-------|------|------------------|---------------|-------------------------|---------|---------|---------|

**\*OPTIONAL AGD (ALUMINIUM GLAZED DOORS) DOORS**

- AGD DOORS INCLUDE SILVER FINISH BAR HANDLES
- THE PRICE SHOWN FOR AGD DOORS IS AN UPCHARGE THAT MUST BE ADDED TO THE BASE PRICE OF THE UNIT IT GOES ON

AGD FINISHES CLEAR (CL), FROSTED (FR) OR BRONZE (BR)

**MID-HEIGHT CABINET STORAGE LEFT W/ 24" RETURN**

LEFT DESK, HINGED LEFT

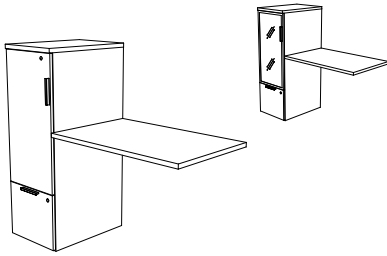

LEV-2436-4816CF-L-AGD  
LEV-2436-4816CF-L

|                   |         |       |       |      |       |       |       |
|-------------------|---------|-------|-------|------|-------|-------|-------|
| LEV-2424-4816CF-L | \$1,657 | \$442 | 93    | 12.4 | 39.5  | 23.75 | 47.75 |
| LEV-2430-4816CF-L | \$1,674 | \$442 | 96.5  | 12.5 | 45.25 | 23.75 | 47.75 |
| LEV-2436-4816CF-L | \$1,692 | \$442 | 99.9  | 12.6 | 51.25 | 23.75 | 47.75 |
| LEV-2442-4816CF-L | \$1,703 | \$442 | 103.3 | 12.8 | 57.25 | 23.75 | 47.75 |
| LEV-2448-4816CF-L | \$1,718 | \$442 | 106.8 | 12.9 | 63    | 23.75 | 47.75 |

**MID-HEIGHT CABINET STORAGE RIGHT W/ 24" RETURN**

RIGHT DESK, HINGED RIGHT

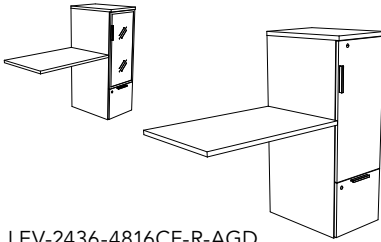

LEV-2436-4816CF-R-AGD  
LEV-2436-4816CF-R

|                   |         |       |       |      |       |       |       |
|-------------------|---------|-------|-------|------|-------|-------|-------|
| LEV-2424-4816CF-R | \$1,657 | \$442 | 93    | 12.4 | 39.5  | 23.75 | 47.75 |
| LEV-2430-4816CF-R | \$1,674 | \$442 | 96.5  | 12.5 | 45.25 | 23.75 | 47.75 |
| LEV-2436-4816CF-R | \$1,692 | \$442 | 99.9  | 12.6 | 51.25 | 23.75 | 47.75 |
| LEV-2442-4816CF-R | \$1,703 | \$442 | 103.3 | 12.8 | 57.25 | 23.75 | 47.75 |
| LEV-2448-4816CF-R | \$1,718 | \$442 | 106.8 | 12.9 | 63    | 23.75 | 47.75 |

- FILE DRAWER & CABINET LOCK. 2 ADJUSTABLE SHELVES

**MID-HEIGHT CABINET STORAGE LEFT W/ STORAGE RISER & 24" RETURN**

LEFT DESK, HINGED LEFT

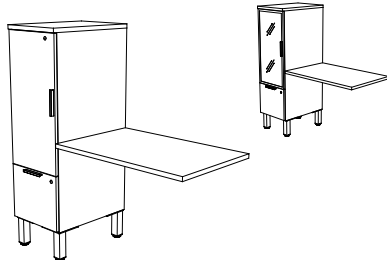

LEV-2436-5516CF-L-SR-AGD  
LEV-2436-5516CF-L-SR

|                      |         |       |       |      |       |       |       |
|----------------------|---------|-------|-------|------|-------|-------|-------|
| LEV-2424-5516CF-L-SR | \$1,715 | \$442 | 106.3 | 14.1 | 39.5  | 23.75 | 54.75 |
| LEV-2430-5516CF-L-SR | \$1,732 | \$442 | 109.7 | 14.2 | 45.25 | 23.75 | 54.75 |
| LEV-2436-5516CF-L-SR | \$1,750 | \$442 | 113.1 | 14.3 | 51.25 | 23.75 | 54.75 |
| LEV-2442-5516CF-L-SR | \$1,761 | \$442 | 116.6 | 14.5 | 57.25 | 23.75 | 54.75 |
| LEV-2448-5516CF-L-SR | \$1,776 | \$442 | 120   | 14.6 | 63    | 23.75 | 54.75 |

**MID-HEIGHT CABINET STORAGE RIGHT STORAGE RISER & 24" RETURN**

RIGHT DESK, HINGED RIGHT

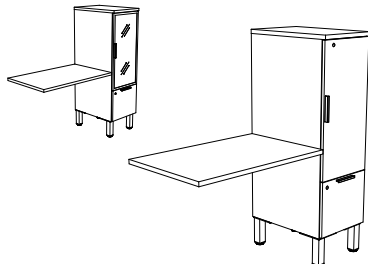

LEV-2436-5516CF-R-SR-AGD  
LEV-2436-5516CF-R-SR

|                      |         |       |       |      |       |       |       |
|----------------------|---------|-------|-------|------|-------|-------|-------|
| LEV-2424-5516CF-R-SR | \$1,715 | \$442 | 106.3 | 14.1 | 39.5  | 23.75 | 54.75 |
| LEV-2430-5516CF-R-SR | \$1,732 | \$442 | 109.7 | 14.2 | 45.25 | 23.75 | 54.75 |
| LEV-2436-5516CF-R-SR | \$1,750 | \$442 | 113.1 | 14.3 | 51.25 | 23.75 | 54.75 |
| LEV-2442-5516CF-R-SR | \$1,761 | \$442 | 116.6 | 14.5 | 57.25 | 23.75 | 54.75 |
| LEV-2448-5516CF-R-SR | \$1,776 | \$442 | 120   | 14.6 | 63    | 23.75 | 54.75 |

- FILE DRAWER & CABINET LOCK. 2 ADJUSTABLE SHELVES

**LEVELS SERIES**  
**MID-HEIGHT CABINET STORAGE RETURNS**

| MODEL | LIST | *AGD     | WEIGHT | CUBE            | W  | D  | H  |
|-------|------|----------|--------|-----------------|----|----|----|
|       |      | UPCHARGE | LBS    | FT <sup>3</sup> | IN | IN | IN |

**MID-HEIGHT CABINET STORAGE LEFT & 24" RETURN**

LEFT DESK, HINGED LEFT

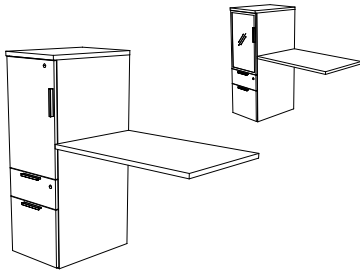

|                    |                |       |      |      |       |       |       |
|--------------------|----------------|-------|------|------|-------|-------|-------|
| LEV-2424-4816CBF-L | <b>\$1,784</b> | \$442 | 87.3 | 12.4 | 39.5  | 23.75 | 47.75 |
| LEV-2430-4816CBF-L | <b>\$1,802</b> | \$442 | 90.7 | 12.5 | 45.25 | 23.75 | 47.75 |
| LEV-2436-4816CBF-L | <b>\$1,819</b> | \$442 | 94.2 | 12.6 | 51.25 | 23.75 | 47.75 |
| LEV-2442-4816CBF-L | <b>\$1,832</b> | \$442 | 97.6 | 12.8 | 57.25 | 23.75 | 47.75 |
| LEV-2448-4816CBF-L | <b>\$1,845</b> | \$442 | 101  | 12.9 | 63    | 23.75 | 47.75 |

LEV-2436-4816CBF-L-AGD  
 LEV-2436-4816CBF-L

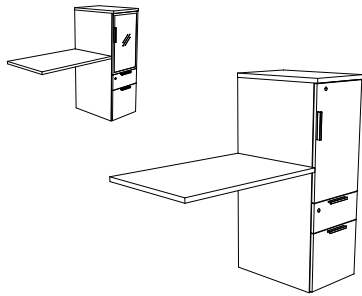

**MID-HEIGHT CABINET STORAGE RIGHT & 24" RETURN**

RIGHT DESK, HINGED RIGHT

|                    |                |       |      |      |       |       |       |
|--------------------|----------------|-------|------|------|-------|-------|-------|
| LEV-2424-4816CBF-R | <b>\$1,784</b> | \$442 | 87.3 | 12.4 | 39.5  | 23.75 | 47.75 |
| LEV-2430-4816CBF-R | <b>\$1,802</b> | \$442 | 90.7 | 12.5 | 45.25 | 23.75 | 47.75 |
| LEV-2436-4816CBF-R | <b>\$1,819</b> | \$442 | 94.2 | 12.6 | 51.25 | 23.75 | 47.75 |
| LEV-2442-4816CBF-R | <b>\$1,832</b> | \$442 | 97.6 | 12.8 | 57.25 | 23.75 | 47.75 |
| LEV-2448-4816CBF-R | <b>\$1,845</b> | \$442 | 101  | 12.9 | 63    | 23.75 | 47.75 |

- BOX/FILE DRAWER & CABINET LOCK. 2 ADJUSTABLE SHELVES

LEV-2436-4816CBF-R-AGD  
 LEV-2436-4816CBF-R

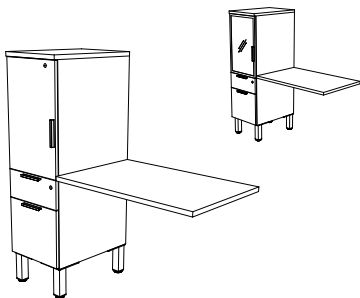

**MID-HEIGHT CABINET STORAGE LEFT W/ STORAGE RISER & 24" RETURN**

LEFT DESK, HINGED LEFT

|                       |                |       |       |      |       |       |       |
|-----------------------|----------------|-------|-------|------|-------|-------|-------|
| LEV-2424-5516CBF-L-SR | <b>\$1,842</b> | \$442 | 106.3 | 14.1 | 39.5  | 23.75 | 54.75 |
| LEV-2430-5516CBF-L-SR | <b>\$1,860</b> | \$442 | 109.7 | 14.2 | 45.25 | 23.75 | 54.75 |
| LEV-2436-5516CBF-L-SR | <b>\$1,877</b> | \$442 | 113.1 | 14.3 | 51.25 | 23.75 | 54.75 |
| LEV-2442-5516CBF-L-SR | <b>\$1,890</b> | \$442 | 116.6 | 14.5 | 57.25 | 23.75 | 54.75 |
| LEV-2448-5516CBF-L-SR | <b>\$1,903</b> | \$442 | 120   | 14.6 | 63    | 23.75 | 54.75 |

LEV-2436-5516CBF-L-SR-AGD  
 LEV-2436-5516CBF-L-SR

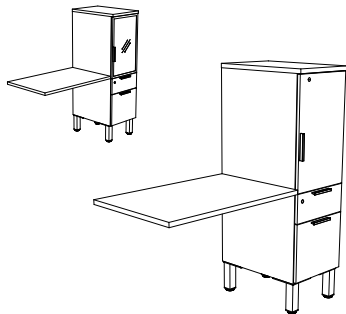

**MID-HEIGHT CABINET STORAGE RIGHT W/ STORAGE RISER & 24" RETURN**

RIGHT DESK, HINGED RIGHT

|                       |                |       |       |      |       |       |       |
|-----------------------|----------------|-------|-------|------|-------|-------|-------|
| LEV-2424-5516CBF-R-SR | <b>\$1,842</b> | \$442 | 106.3 | 14.1 | 39.5  | 23.75 | 54.75 |
| LEV-2430-5516CBF-R-SR | <b>\$1,860</b> | \$442 | 109.7 | 14.2 | 45.25 | 23.75 | 54.75 |
| LEV-2436-5516CBF-R-SR | <b>\$1,877</b> | \$442 | 113.1 | 14.3 | 51.25 | 23.75 | 54.75 |
| LEV-2442-5516CBF-R-SR | <b>\$1,890</b> | \$442 | 116.6 | 14.5 | 57.25 | 23.75 | 54.75 |
| LEV-2448-5516CBF-R-SR | <b>\$1,903</b> | \$442 | 120   | 14.6 | 63    | 23.75 | 54.75 |

- BOX/FILE DRAWER & CABINET LOCK. 2 ADJUSTABLE SHELVES

LEV-2436-5516CBF-R-SR-AGD  
 LEV-2436-5516CBF-R-SR

| MODEL | LIST | *AGD      | WEIGHT | CUBE            | W  | D  | H  |
|-------|------|-----------|--------|-----------------|----|----|----|
|       |      | UP CHARGE | LBS    | FT <sup>3</sup> | IN | IN | IN |

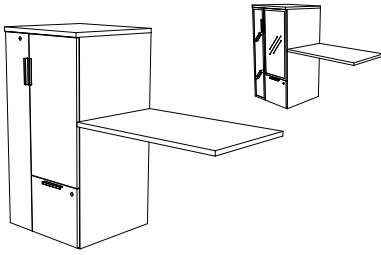

LEV-2436-4824CFWL-AGD  
LEV-2436-4824CFWL

**MID-HEIGHT WARDROBE STORAGE LEFT W/ 24" RETURN**

CABINET/FILE WARDROBE LEFT

|                   |                |       |       |      |       |       |       |
|-------------------|----------------|-------|-------|------|-------|-------|-------|
| LEV-2424-4824CFWL | <b>\$1,782</b> | \$778 | 105.4 | 17.9 | 47.25 | 23.75 | 47.75 |
| LEV-2430-4824CFWL | <b>\$1,800</b> | \$778 | 108.9 | 18   | 53.25 | 23.75 | 47.75 |
| LEV-2436-4824CFWL | <b>\$1,817</b> | \$778 | 112.3 | 18.1 | 59.25 | 23.75 | 47.75 |
| LEV-2442-4824CFWL | <b>\$1,836</b> | \$778 | 115.7 | 18.2 | 65    | 23.75 | 47.75 |
| LEV-2448-4824CFWL | <b>\$1,853</b> | \$778 | 119.2 | 18.4 | 71    | 23.75 | 47.75 |

**MID-HEIGHT WARDROBE STORAGE RIGHT & 24" RETURN**

CABINET/FILE WARDROBE RIGHT

|                   |                |       |       |      |       |       |       |
|-------------------|----------------|-------|-------|------|-------|-------|-------|
| LEV-2424-4824CFWR | <b>\$1,782</b> | \$778 | 105.4 | 17.9 | 47.25 | 23.75 | 47.75 |
| LEV-2430-4824CFWR | <b>\$1,800</b> | \$778 | 108.9 | 18   | 53.25 | 23.75 | 47.75 |
| LEV-2436-4824CFWR | <b>\$1,817</b> | \$778 | 112.3 | 18.1 | 59.25 | 23.75 | 47.75 |
| LEV-2442-4824CFWR | <b>\$1,836</b> | \$778 | 115.7 | 18.2 | 65    | 23.75 | 47.75 |
| LEV-2448-4824CFWR | <b>\$1,853</b> | \$778 | 119.2 | 18.4 | 71    | 23.75 | 47.75 |

- INCLUDES COAT HOOKS & 2 ADJUSTABLE SHELVES
- WARDROBE & FILE DRAWER ARE LOCKING
- OPTIONAL LOCK ON CABINET DOOR SEE PAGE [LEV-6](#)
- OPTIONAL BOOTSHelf AVAILABLE IN WARDROBE, ADD **-BS** TO SKU. UP-CHARGES APPLY SEE [LEV-5](#)

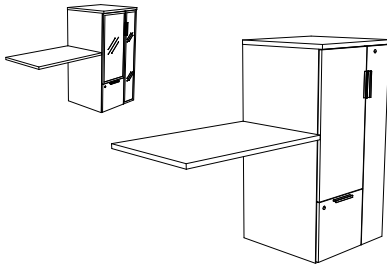

LEV-2436-4824CFWR-AGD  
LEV-2436-4824CFWR

**MID-HEIGHT WARDROBE STORAGE LEFT W/ STORAGE RISER & 24" RETURN**

CABINET/FILE WARDROBE LEFT

|                      |                |       |       |      |       |       |       |
|----------------------|----------------|-------|-------|------|-------|-------|-------|
| LEV-2424-5524CFWL-SR | <b>\$1,840</b> | \$778 | 127.7 | 20.3 | 47.25 | 23.75 | 54.75 |
| LEV-2430-5524CFWL-SR | <b>\$1,858</b> | \$778 | 131.1 | 20.5 | 53.25 | 23.75 | 54.75 |
| LEV-2436-5524CFWL-SR | <b>\$1,875</b> | \$778 | 134.6 | 20.6 | 59.25 | 23.75 | 54.75 |
| LEV-2442-5524CFWL-SR | <b>\$1,894</b> | \$778 | 138   | 20.7 | 65    | 23.75 | 54.75 |
| LEV-2448-5524CFWL-SR | <b>\$1,911</b> | \$778 | 141.4 | 20.9 | 71    | 23.75 | 54.75 |

**MID-HEIGHT WARDROBE STORAGE RIGHT W/ STORAGE RISER & 24" RETURN**

CABINET/FILE WARDROBE RIGHT

|                      |                |       |       |      |       |       |       |
|----------------------|----------------|-------|-------|------|-------|-------|-------|
| LEV-2424-5524CFWR-SR | <b>\$1,840</b> | \$778 | 127.7 | 20.3 | 47.25 | 23.75 | 54.75 |
| LEV-2430-5524CFWR-SR | <b>\$1,858</b> | \$778 | 131.1 | 20.5 | 53.25 | 23.75 | 54.75 |
| LEV-2436-5524CFWR-SR | <b>\$1,875</b> | \$778 | 134.6 | 20.6 | 59.25 | 23.75 | 54.75 |
| LEV-2442-5524CFWR-SR | <b>\$1,894</b> | \$778 | 138   | 20.7 | 65    | 23.75 | 54.75 |
| LEV-2448-5524CFWR-SR | <b>\$1,911</b> | \$778 | 141.4 | 20.9 | 71    | 23.75 | 54.75 |

- INCLUDES COAT HOOKS & 2 ADJUSTABLE SHELVES
- WARDROBE & FILE DRAWER ARE LOCKING
- OPTIONAL LOCK ON CABINET DOOR SEE [LEV-6](#)
- OPTIONAL BOOTSHelf AVAILABLE IN WARDROBE, ADD **-BS** TO SKU. UP-CHARGES APPLY SEE [LEV-5](#)

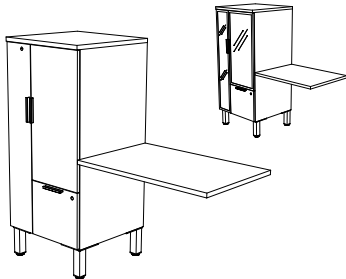

LEV-2436-5524CFWL-SR-AGD  
LEV-2436-5524CFWL-SR

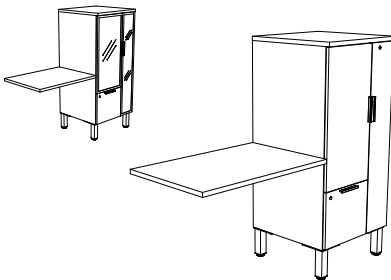

LEV-2436-5524CFWR-SR-AGD  
LEV-2436-5524CFWR-SR

# LEVELS SERIES

## MID-HEIGHT WARDROBE STORAGE RETURNS

| MODEL | LIST     | *AGD | WEIGHT | CUBE            | W  | D  | H  |
|-------|----------|------|--------|-----------------|----|----|----|
|       | UPCHARGE |      | LBS    | FT <sup>3</sup> | IN | IN | IN |

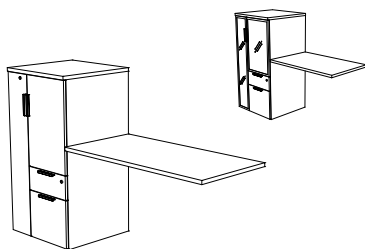

LEV-2448-4824CBFWL-AGD  
LEV-2448-4824CBFWL

### MID-HEIGHT WARDROBE STORAGE LEFT & 24" RETURN

#### CABINET/BOX/FILE WARDROBE LEFT

|                    |                |              |       |      |       |       |       |
|--------------------|----------------|--------------|-------|------|-------|-------|-------|
| LEV-2424-4824CBFWL | <b>\$1,900</b> | <i>\$778</i> | 114.5 | 17.9 | 47.25 | 23.75 | 47.75 |
| LEV-2430-4824CBFWL | <b>\$1,918</b> | <i>\$778</i> | 117.9 | 18   | 53.25 | 23.75 | 47.75 |
| LEV-2436-4824CBFWL | <b>\$1,936</b> | <i>\$778</i> | 121.3 | 18.1 | 59.25 | 23.75 | 47.75 |
| LEV-2442-4824CBFWL | <b>\$1,955</b> | <i>\$778</i> | 124.8 | 18.2 | 65    | 23.75 | 47.75 |
| LEV-2448-4824CBFWL | <b>\$1,971</b> | <i>\$778</i> | 128.2 | 18.4 | 71    | 23.75 | 47.25 |

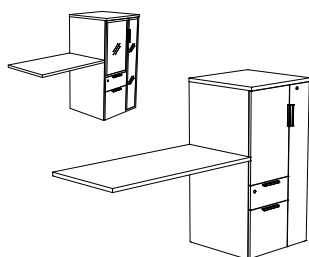

LEV-2448-4824CBFWR-AGD  
LEV-2448-4824CBFWR

### MID-HEIGHT WARDROBE STORAGE RIGHT & 24" RETURN

#### CABINET/BOX/FILE WARDROBE RIGHT

|                    |                |              |       |      |       |       |       |
|--------------------|----------------|--------------|-------|------|-------|-------|-------|
| LEV-2424-4824CBFWR | <b>\$1,900</b> | <i>\$778</i> | 114.5 | 17.9 | 47.25 | 23.75 | 47.75 |
| LEV-2430-4824CBFWR | <b>\$1,918</b> | <i>\$778</i> | 117.9 | 18   | 53.25 | 23.75 | 47.75 |
| LEV-2436-4824CBFWR | <b>\$1,936</b> | <i>\$778</i> | 121.3 | 18.1 | 59.25 | 23.75 | 47.75 |
| LEV-2442-4824CBFWR | <b>\$1,955</b> | <i>\$778</i> | 124.8 | 18.2 | 65    | 23.75 | 47.75 |
| LEV-2448-4824CBFWR | <b>\$1,971</b> | <i>\$778</i> | 128.2 | 18.4 | 71    | 23.75 | 47.75 |

- INCLUDES COAT HOOKS & 2 ADJUSTABLE SHELVES
- WARDROBE & FILE DRAWER ARE LOCKING
- OPTIONAL LOCK ON CABINET DOOR SEE [LEV-6](#)
- OPTIONAL BOOTSHLEF AVAILABLE IN WARDROBE, ADD **-BS** TO SKU. UP-CHARGES APPLY SEE [LEV-5](#)

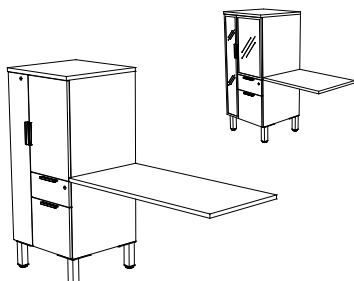

LEV-2448-5524CBFWL-SR-AGD  
LEV-2448-5524CBFWL-SR

### MID-HEIGHT WARDROBE STORAGE LEFT W/ STORAGE RISER & 24" RETURN

#### CABINET/BOX/FILE WARDROBE LEFT

|                       |                |              |       |      |       |       |       |
|-----------------------|----------------|--------------|-------|------|-------|-------|-------|
| LEV-2424-5524CBFWL-SR | <b>\$1,958</b> | <i>\$778</i> | 127.7 | 20.3 | 47.25 | 23.75 | 54.75 |
| LEV-2430-5524CBFWL-SR | <b>\$1,976</b> | <i>\$778</i> | 131.1 | 20.5 | 53.25 | 23.75 | 54.75 |
| LEV-2436-5524CBFWL-SR | <b>\$1,994</b> | <i>\$778</i> | 134.6 | 20.6 | 59.25 | 23.75 | 54.75 |
| LEV-2442-5524CBFWL-SR | <b>\$2,013</b> | <i>\$778</i> | 138   | 20.7 | 65    | 23.75 | 54.75 |
| LEV-2448-5524CBFWL-SR | <b>\$2,029</b> | <i>\$778</i> | 141.4 | 20.9 | 71    | 23.75 | 54.75 |

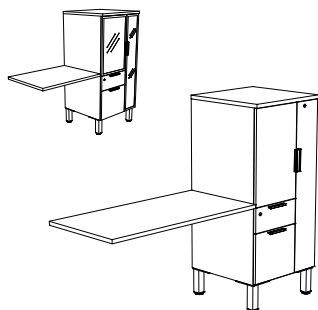

LEV-2448-5524CBFWR-SR-AGD  
LEV-2448-5524CBFWR-SR

### MID-HEIGHT WARDROBE STORAGE RIGHT W/ STORAGE RISER & 24" RETURN

#### CABINET/BOX/FILE WARDROBE RIGHT

|                       |                |              |       |      |       |       |       |
|-----------------------|----------------|--------------|-------|------|-------|-------|-------|
| LEV-2424-5524CBFWR-SR | <b>\$1,958</b> | <i>\$778</i> | 127.7 | 20.3 | 47.25 | 23.75 | 54.75 |
| LEV-2430-5524CBFWR-SR | <b>\$1,976</b> | <i>\$778</i> | 131.1 | 20.5 | 53.25 | 23.75 | 54.75 |
| LEV-2436-5524CBFWR-SR | <b>\$1,994</b> | <i>\$778</i> | 134.6 | 20.6 | 59.25 | 23.75 | 54.75 |
| LEV-2442-5524CBFWR-SR | <b>\$2,013</b> | <i>\$778</i> | 138   | 20.7 | 65    | 23.75 | 54.75 |
| LEV-2448-5524CBFWR-SR | <b>\$2,029</b> | <i>\$778</i> | 141.4 | 20.9 | 71    | 23.75 | 54.75 |

- INCLUDES COAT HOOKS & 2 ADJUSTABLE SHELVES
- WARDROBE & FILE DRAWER ARE LOCKING
- OPTIONAL LOCK ON CABINET DOOR SEE [LEV-6](#)
- OPTIONAL BOOTSHLEF AVAILABLE IN WARDROBE, ADD **-BS** TO SKU. UP-CHARGES APPLY SEE [LEV-5](#)



| MODEL | LIST      | *AGD | WEIGHT | CUBE            | W  | D  | H  |
|-------|-----------|------|--------|-----------------|----|----|----|
|       | UP CHARGE |      | LBS    | FT <sup>3</sup> | IN | IN | IN |

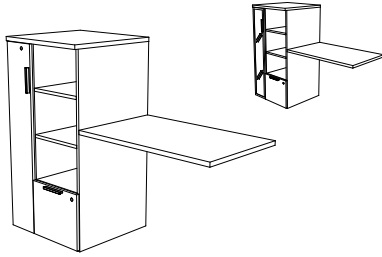

LEV-2436-4824OFWL-AGD  
LEV-2436-4824OFWL

**MID-HEIGHT OPEN WARDROBE STORAGE WARDROBE LEFT & 24" RETURN**

OPEN/FILE WARDROBE LEFT

|                   |                |       |       |      |       |       |       |
|-------------------|----------------|-------|-------|------|-------|-------|-------|
| LEV-2424-4824OFWL | <b>\$1,756</b> | \$544 | 140.8 | 17.9 | 47.25 | 23.75 | 47.75 |
| LEV-2430-4824OFWL | <b>\$1,774</b> | \$544 | 144.2 | 18   | 53.25 | 23.75 | 47.75 |
| LEV-2436-4824OFWL | <b>\$1,791</b> | \$544 | 147.7 | 18.1 | 59.25 | 23.75 | 47.75 |
| LEV-2442-4824OFWL | <b>\$1,810</b> | \$544 | 151.1 | 18.2 | 65    | 23.75 | 47.75 |
| LEV-2448-4824OFWL | <b>\$1,827</b> | \$544 | 154.5 | 18.4 | 71    | 23.75 | 47.75 |

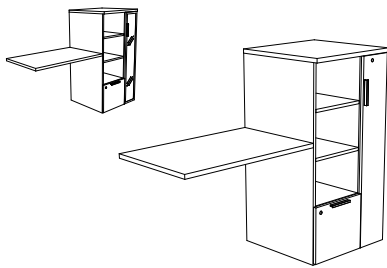

LEV-2436-4824OFWR-AGD  
LEV-2436-4824OFWR

**MID-HEIGHT OPEN WARDROBE STORAGE WARDROBE RIGHT & 24" RETURN**

OPEN/FILE WARDROBE RIGHT

|                   |                |       |       |      |       |       |       |
|-------------------|----------------|-------|-------|------|-------|-------|-------|
| LEV-2424-4824OFWR | <b>\$1,756</b> | \$544 | 140.8 | 17.9 | 47.25 | 23.75 | 47.75 |
| LEV-2430-4824OFWR | <b>\$1,774</b> | \$544 | 144.2 | 18   | 53.25 | 23.75 | 47.75 |
| LEV-2436-4824OFWR | <b>\$1,791</b> | \$544 | 147.7 | 18.1 | 59.25 | 23.75 | 47.75 |
| LEV-2442-4824OFWR | <b>\$1,810</b> | \$544 | 151.1 | 18.2 | 65    | 23.75 | 47.75 |
| LEV-2448-4824OFWR | <b>\$1,827</b> | \$544 | 154.5 | 18.4 | 71    | 23.75 | 47.75 |

- INCLUDES COAT HOCKS & HAT SHELF
- LOCKING FILE DRAWER & WARDROBE
- 2 ADJUSTABLE SHELVES IN CABINET
- OPTIONAL BOOTSHelf AVAILABLE IN WARDROBE, ADD **-BS** TO SKU. UP-CHARGES APPLY SEE [LEV-5](#)

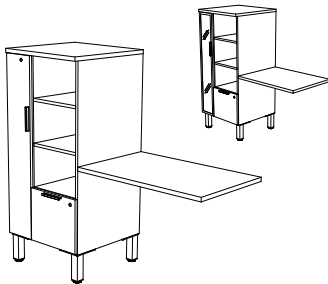

LEV-2436-5524OFWL-SR-AGD  
LEV-2436-5524OFWL-SR

**MID-HEIGHT OPEN WARDROBE STORAGE WARDROBE LEFT W/ STORAGE RISER & 24" RETURN**

OPEN/FILE WARDROBE LEFT

|                      |                |       |       |      |       |       |       |
|----------------------|----------------|-------|-------|------|-------|-------|-------|
| LEV-2424-5524OFWL-SR | <b>\$1,814</b> | \$544 | 154.2 | 20.3 | 47.25 | 23.75 | 54.75 |
| LEV-2430-5524OFWL-SR | <b>\$1,832</b> | \$544 | 157.6 | 20.5 | 53.25 | 23.75 | 54.75 |
| LEV-2436-5524OFWL-SR | <b>\$1,849</b> | \$544 | 161   | 20.6 | 59.25 | 23.75 | 54.75 |
| LEV-2442-5524OFWL-SR | <b>\$1,868</b> | \$544 | 164.5 | 20.7 | 65    | 23.75 | 54.75 |
| LEV-2448-5524OFWL-SR | <b>\$1,885</b> | \$544 | 167.9 | 20.9 | 71    | 23.75 | 54.75 |

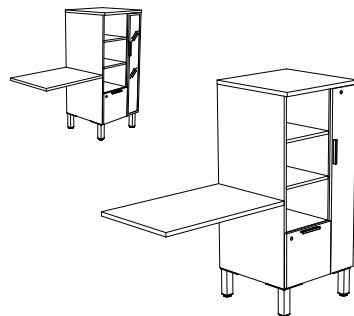

LEV-2436-5524OFWR-SR-AGD  
LEV-2436-5524OFWR-SR

**MID-HEIGHT OPEN WARDROBE STORAGE WARDROBE RIGHT W/ STORAGE RISER & 24" RETURN**

OPEN/FILE WARDROBE RIGHT

|                      |                |       |       |      |       |       |       |
|----------------------|----------------|-------|-------|------|-------|-------|-------|
| LEV-2424-5524OFWR-SR | <b>\$1,814</b> | \$544 | 154.2 | 20.3 | 47.25 | 23.75 | 54.75 |
| LEV-2430-5524OFWR-SR | <b>\$1,832</b> | \$544 | 157.6 | 20.5 | 53.25 | 23.75 | 54.75 |
| LEV-2436-5524OFWR-SR | <b>\$1,849</b> | \$544 | 161   | 20.6 | 59.25 | 23.75 | 54.75 |
| LEV-2442-5524OFWR-SR | <b>\$1,868</b> | \$544 | 164.5 | 20.7 | 65    | 23.75 | 54.75 |
| LEV-2448-5524OFWR-SR | <b>\$1,885</b> | \$544 | 167.9 | 20.9 | 71    | 23.75 | 54.75 |

- INCLUDES COAT HOCKS & HAT SHELF
- LOCKING FILE DRAWER & WARDROBE
- 2 ADJUSTABLE SHELVES IN CABINET
- OPTIONAL BOOTSHelf AVAILABLE IN WARDROBE, ADD **-BS** TO SKU. UP-CHARGES APPLY SEE [LEV-5](#)

**LEVELS SERIES**  
**MID-HEIGHT WARDROBE STORAGE RETURNS**

| MODEL | LIST | *AGD     | WEIGHT | CUBE            | W  | D  | H  |
|-------|------|----------|--------|-----------------|----|----|----|
|       |      | UPCHARGE | LBS    | FT <sup>3</sup> | IN | IN | IN |

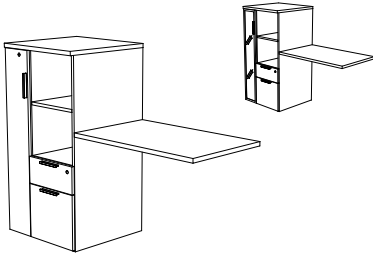

LEV-2436-4824OBFWL-AGD  
 LEV-2436-4824OBFWL

**MID-HEIGHT OPEN WARDROBE STORAGE WARDROBE LEFT & 24" RETURN**

OPEN/BOX/FILE WARDROBE LEFT

|                    |                |       |       |      |       |       |       |
|--------------------|----------------|-------|-------|------|-------|-------|-------|
| LEV-2424-4824OBFWL | <b>\$1,876</b> | \$544 | 128   | 17.9 | 47.25 | 23.75 | 47.75 |
| LEV-2430-4824OBFWL | <b>\$1,893</b> | \$544 | 131.5 | 18   | 53.25 | 23.75 | 47.75 |
| LEV-2436-4824OBFWL | <b>\$1,911</b> | \$544 | 134.9 | 18.1 | 59.25 | 23.75 | 47.75 |
| LEV-2442-4824OBFWL | <b>\$1,929</b> | \$544 | 138.3 | 18.2 | 65    | 23.75 | 47.75 |
| LEV-2448-4824OBFWL | <b>\$1,946</b> | \$544 | 141.8 | 18.4 | 71    | 23.75 | 47.75 |

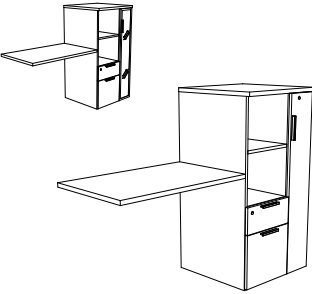

LEV-2436-4824OBFWR-AGD  
 LEV-2436-4824OBFWR

**MID-HEIGHT OPEN WARDROBE STORAGE WARDROBE RIGHT & 24" RETURN**

OPEN/BOX/FILE WARDROBE RIGHT

|                    |                |       |       |      |       |       |       |
|--------------------|----------------|-------|-------|------|-------|-------|-------|
| LEV-2424-4824OBFWR | <b>\$1,876</b> | \$544 | 128   | 17.9 | 47.25 | 23.75 | 47.75 |
| LEV-2430-4824OBFWR | <b>\$1,893</b> | \$544 | 131.5 | 18   | 53.25 | 23.75 | 47.75 |
| LEV-2436-4824OBFWR | <b>\$1,911</b> | \$544 | 134.9 | 18.1 | 59.25 | 23.75 | 47.75 |
| LEV-2442-4824OBFWR | <b>\$1,929</b> | \$544 | 138.3 | 18.2 | 65    | 23.75 | 47.75 |
| LEV-2448-4824OBFWR | <b>\$1,946</b> | \$544 | 141.8 | 18.4 | 71    | 23.75 | 47.75 |

- INCLUDES COAT HOOKS & HAT SHELF
- LOCKING BOX/FILE DRAWER & WARDROBE
- 2 ADJUSTABLE SHELVES IN CABINET
- OPTIONAL BOOTSHelf AVAILABLE IN WARDROBE, ADD **-BS** TO SKU. UP-CHARGES APPLY SEE [LEV-5](#)

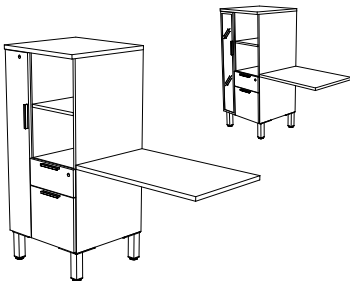

LEV-2436-5524OBFWL-SR-AGD  
 LEV-2436-5524OBFWL-SR

**MID-HEIGHT OPEN WARDROBE STORAGE WARDROBE LEFT W/ STORAGE RISER & 24" RETURN**

OPEN/BOX/FILE WARDROBE LEFT

|                       |                |       |       |      |       |       |       |
|-----------------------|----------------|-------|-------|------|-------|-------|-------|
| LEV-2424-5524OBFWL-SR | <b>\$1,934</b> | \$544 | 150.4 | 20.3 | 47.25 | 23.75 | 54.75 |
| LEV-2430-5524OBFWL-SR | <b>\$1,951</b> | \$544 | 153.8 | 20.5 | 53.25 | 23.75 | 54.75 |
| LEV-2436-5524OBFWL-SR | <b>\$1,969</b> | \$544 | 157.2 | 20.6 | 59.25 | 23.75 | 54.75 |
| LEV-2442-5524OBFWL-SR | <b>\$1,987</b> | \$544 | 160.7 | 20.7 | 65    | 23.75 | 54.75 |
| LEV-2448-5524OBFWL-SR | <b>\$2,004</b> | \$544 | 164.1 | 20.9 | 71    | 23.75 | 54.75 |

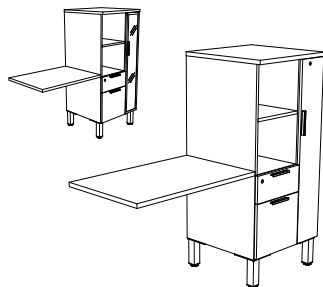

LEV-2436-5524OBFWR-SR-AGD  
 LEV-2436-5524OBFWR-SR

**MID-HEIGHT OPEN WARDROBE STORAGE WARDROBE RIGHT W/ STORAGE RISER & 24" RETURN**

OPEN/BOX/FILE WARDROBE RIGHT

|                       |                |       |       |      |       |       |       |
|-----------------------|----------------|-------|-------|------|-------|-------|-------|
| LEV-2424-5524OBFWR-SR | <b>\$1,934</b> | \$544 | 150.4 | 20.3 | 47.25 | 23.75 | 54.75 |
| LEV-2430-5524OBFWR-SR | <b>\$1,951</b> | \$544 | 153.8 | 20.5 | 53.25 | 23.75 | 54.75 |
| LEV-2436-5524OBFWR-SR | <b>\$1,969</b> | \$544 | 157.2 | 20.6 | 59.25 | 23.75 | 54.75 |
| LEV-2442-5524OBFWR-SR | <b>\$1,987</b> | \$544 | 160.7 | 20.7 | 65    | 23.75 | 54.75 |
| LEV-2448-5524OBFWR-SR | <b>\$2,004</b> | \$544 | 164.1 | 20.9 | 71    | 23.75 | 54.75 |

- INCLUDES COAT HOOKS & HAT SHELF
- LOCKING BOX/FILE DRAWER & WARDROBE
- 2 ADJUSTABLE SHELVES IN CABINET
- OPTIONAL BOOTSHelf AVAILABLE IN WARDROBE, ADD **-BS** TO SKU. UP-CHARGES APPLY SEE [LEV-5](#)

| MODEL | LIST     | *AGD | WEIGHT | CUBE            | W  | D  | H  |
|-------|----------|------|--------|-----------------|----|----|----|
|       | UPCHARGE |      | LBS    | FT <sup>3</sup> | IN | IN | IN |

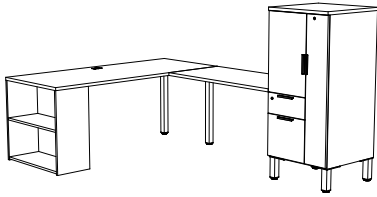

| EXAMPLE 1             |   |
|-----------------------|---|
| LEV-3072TBLSQ2-COX    | TABLE W/ OPEN CABINET & SQUARE OFFSET LEGS                      |
| LEV-2448-5524CBFWR-SR | MID-HEIGHT WARDROBE STORAGE RIGHT W/ STORAGE RISER & 48" RETURN |

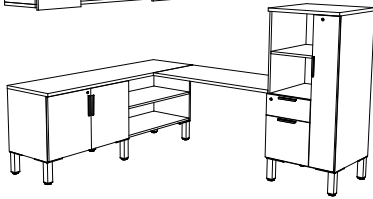
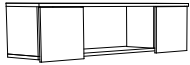

| EXAMPLE 2             |   |
|-----------------------|---|
| LEV-C2072CO-SR29      | CABINET CREDENZA/OPEN SHELF W/ STORAGE RISER                                  |
| LEV-1772OSH2          | OVERHEAD STORAGE - W/ 2 DOORS   |
| LEV-2448-5524OBFWR-SR | MID-HEIGHT OPEN WARDROBE STORAGE WARDROBE RIGHT W/ STORAGE RISER & 48" RETURN |

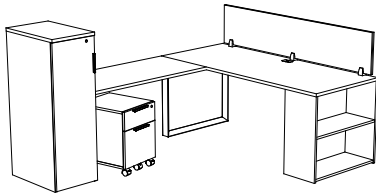

| EXAMPLE 3            |  |
|----------------------|--|
| LEV-2448-4816MCL-L   | MID-HEIGHT SINGLE DOOR CLOSET CABINET & 48" RETURN |
| LEV-3072TBL-LOOP-COX | TABLE W/ OPEN CABINET & LOOP LEG                   |
| TM1-1572TBP          | 15" TOP MOUNT TACK BOARD PRIVACY PANEL             |
| LEV-1622MPF          | MOBILE PEDESTAL                                    |

**MID-HEIGHT STORAGE CABINETS**

**OPTIONAL AGD (ALUMINIUM GLAZED DOORS) DOORS**

- AGD DOORS INCLUDE SILVER FINISH BAR HANDLES
- THE PRICE SHOWN FOR AGD DOORS IS AN UPCHARGE THAT MUST BE ADDED TO THE BASE PRICE OF THE UNIT IT GOES ON

AGD FINISHES CLEAR (CL), FROSTED (FR) OR BRONZE (BR)

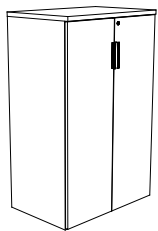

LEV-4836C-20  
LEV-4836C-20-AGD

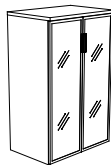

**MID-HEIGHT CABINET**

20" DEEP W/ 1 FIXED SHELF, 2 ADJUSTABLE SHELVES & LOCKING CABINET DOORS

|              |                |                |     |    |      |       |       |
|--------------|----------------|----------------|-----|----|------|-------|-------|
| LEV-4830C-20 | <b>\$1,262</b> | <i>\$863</i>   | 182 | 21 | 29.5 | 19.75 | 47.75 |
| LEV-4836C-20 | <b>\$1,358</b> | <i>\$1,019</i> | 200 | 24 | 35.5 | 19.75 | 47.75 |

24" DEEP W/ 1 FIXED SHELF, 2 ADJUSTABLE SHELVES & LOCKING CABINET DOORS

|              |                |                |     |    |      |       |       |
|--------------|----------------|----------------|-----|----|------|-------|-------|
| LEV-4830C-24 | <b>\$1,408</b> | <i>\$863</i>   | 201 | 24 | 29.5 | 23.75 | 47.75 |
| LEV-4836C-24 | <b>\$1,522</b> | <i>\$1,019</i> | 220 | 26 | 35.5 | 23.75 | 47.75 |

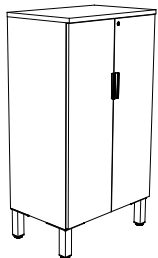

LEV-5536C-20-SR  
LEV-5536C-20-SR-AGD

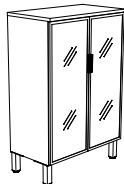

**MID-HEIGHT CABINET W/ STORAGE RISER**

20" DEEP W/ 1 FIXED SHELF, 2 ADJUSTABLE SHELVES & LOCKING CABINET DOORS

|                 |                |                |       |    |      |       |       |
|-----------------|----------------|----------------|-------|----|------|-------|-------|
| LEV-5530C-20-SR | <b>\$1,320</b> | <i>\$863</i>   | 145.6 | 22 | 29.5 | 19.75 | 54.75 |
| LEV-5536C-20-SR | <b>\$1,416</b> | <i>\$1,019</i> | 165   | 26 | 35.5 | 19.75 | 54.75 |

24" DEEP W/ 1 FIXED SHELF, 2 ADJUSTABLE SHELVES & LOCKING CABINET DOORS

|                 |                |                |       |    |      |       |       |
|-----------------|----------------|----------------|-------|----|------|-------|-------|
| LEV-5530C-24-SR | <b>\$1,466</b> | <i>\$863</i>   | 165   | 26 | 29.5 | 23.75 | 54.75 |
| LEV-5536C-24-SR | <b>\$1,580</b> | <i>\$1,019</i> | 186.6 | 30 | 35.5 | 23.75 | 54.75 |

# LEVELS SERIES

## MID-HEIGHT STORAGE CABINETS

| MODEL | LIST     | *AGD | WEIGHT | CUBE            | W  | D  | H  |
|-------|----------|------|--------|-----------------|----|----|----|
|       | UPCHARGE |      | LBS    | FT <sup>3</sup> | IN | IN | IN |

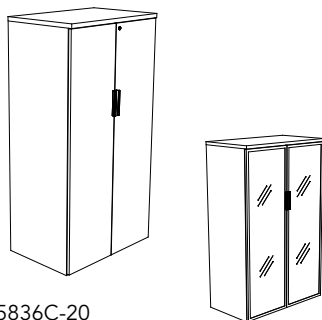

LEV-5836C-20  
LEV-5836C-20-AGD

### MID-HEIGHT CABINET

20" DEEP W/ 1 FIXED SHELF, 2 ADJUSTABLE SHELVES & LOCKING CABINET DOORS

|              |                |                |     |    |      |       |      |
|--------------|----------------|----------------|-----|----|------|-------|------|
| LEV-5830C-20 | <b>\$1,476</b> | <i>\$898</i>   | 165 | 26 | 29.5 | 19.75 | 57.5 |
| LEV-5836C-20 | <b>\$1,627</b> | <i>\$1,047</i> | 165 | 26 | 35.5 | 19.75 | 57.5 |

24" DEEP W/ 1 FIXED SHELF, 2 ADJUSTABLE SHELVES & LOCKING CABINET DOORS

|              |                |                |     |    |      |       |      |
|--------------|----------------|----------------|-----|----|------|-------|------|
| LEV-5830C-24 | <b>\$1,588</b> | <i>\$898</i>   | 165 | 26 | 29.5 | 23.75 | 57.5 |
| LEV-5836C-24 | <b>\$1,752</b> | <i>\$1,047</i> | 165 | 26 | 35.5 | 23.75 | 57.5 |

- TO ADD BOOTSHelf, ADD -BS TO SKU. UP-CHARGES APPLY SEE [LEV-5](#)
- FOR TALL CABINETS SEE [LEV-76](#)

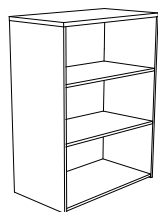

LEV-4836CO-20

### OPEN MID-HEIGHT CABINET

20" DEEP W/ 1 FIXED SHELF & 2 ADJUSTABLE SHELVES

|               |                |            |     |    |       |       |       |
|---------------|----------------|------------|-----|----|-------|-------|-------|
| LEV-4818CO-20 | <b>\$1,012</b> | <i>N/A</i> | 155 | 16 | 17.75 | 19.75 | 47.75 |
| LEV-4824CO-20 | <b>\$1,118</b> | <i>N/A</i> | 172 | 18 | 23.75 | 19.75 | 47.75 |
| LEV-4830CO-20 | <b>\$1,158</b> | <i>N/A</i> | 192 | 20 | 29.5  | 19.75 | 47.75 |
| LEV-4836CO-20 | <b>\$1,233</b> | <i>N/A</i> | 200 | 22 | 35.5  | 19.75 | 47.75 |

24" DEEP W/ 1 FIXED SHELF & 2 ADJUSTABLE SHELVES

|               |                |            |     |    |       |       |       |
|---------------|----------------|------------|-----|----|-------|-------|-------|
| LEV-4818CO-24 | <b>\$1,108</b> | <i>N/A</i> | 160 | 18 | 17.75 | 23.75 | 47.75 |
| LEV-4824CO-24 | <b>\$1,214</b> | <i>N/A</i> | 187 | 20 | 23.75 | 23.75 | 47.75 |
| LEV-4830CO-24 | <b>\$1,251</b> | <i>N/A</i> | 207 | 22 | 29.5  | 23.75 | 47.75 |
| LEV-4836CO-24 | <b>\$1,327</b> | <i>N/A</i> | 215 | 24 | 35.5  | 23.75 | 47.75 |

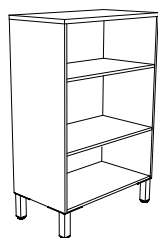

LEV-5536CO-20-SR

### OPEN MID-HEIGHT CABINET W/ STORAGE RISER

20" DEEP W/ 1 FIXED SHELF & 2 ADJUSTABLE SHELVES

|                  |                |            |       |      |       |       |       |
|------------------|----------------|------------|-------|------|-------|-------|-------|
| LEV-5518CO-20-SR | <b>\$1,070</b> | <i>N/A</i> | 92    | 13.5 | 17.75 | 19.75 | 54.75 |
| LEV-5524CO-20-SR | <b>\$1,176</b> | <i>N/A</i> | 108.1 | 17.6 | 23.75 | 19.75 | 54.75 |
| LEV-5530CO-20-SR | <b>\$1,216</b> | <i>N/A</i> | 124.3 | 21.6 | 29.5  | 19.75 | 54.75 |
| LEV-5536CO-20-SR | <b>\$1,291</b> | <i>N/A</i> | 140.5 | 25.7 | 35.5  | 19.75 | 54.75 |

24" DEEP W/ 1 FIXED SHELF & 2 ADJUSTABLE SHELVES

|                  |                |            |       |      |       |       |       |
|------------------|----------------|------------|-------|------|-------|-------|-------|
| LEV-5518CO-24-SR | <b>\$1,166</b> | <i>N/A</i> | 105.2 | 16   | 17.75 | 23.75 | 54.75 |
| LEV-5524CO-24-SR | <b>\$1,272</b> | <i>N/A</i> | 123.7 | 20.8 | 23.75 | 23.75 | 54.75 |
| LEV-5530CO-24-SR | <b>\$1,309</b> | <i>N/A</i> | 142.2 | 25.5 | 29.5  | 23.75 | 54.75 |
| LEV-5536CO-24-SR | <b>\$1,385</b> | <i>N/A</i> | 160.7 | 30.3 | 35.5  | 23.75 | 54.75 |

| MODEL | LIST | *AGD     | WEIGHT | CUBE            | W  | D  | H  |
|-------|------|----------|--------|-----------------|----|----|----|
|       |      | UPCHARGE | LBS    | FT <sup>3</sup> | IN | IN | IN |

**MID-HEIGHT CLOSET CABINET**

INCLUDES COAT ROD. OPTIONAL BOOT SHELF AVAILABLE. LOCKING.

HINGED LEFT

|                 |                |       |       |      |       |       |       |
|-----------------|----------------|-------|-------|------|-------|-------|-------|
| LEV-4816MCL24-L | <b>\$989</b>   | \$442 | 79.3  | 12.6 | 15.75 | 23.75 | 47.75 |
| LEV-4824MCL24-L | <b>\$1,385</b> | \$544 | 100.6 | 18.1 | 23.75 | 23.75 | 47.75 |
| LEV-5816MCL24-L | <b>\$1,138</b> | \$586 | 92.9  | 15.2 | 15.75 | 23.75 | 57.5  |
| LEV-5824MCL24-L | <b>\$1,535</b> | \$671 | 117.4 | 21.9 | 23.75 | 23.75 | 57.5  |

HINGED RIGHT

|                 |                |       |       |      |       |       |       |
|-----------------|----------------|-------|-------|------|-------|-------|-------|
| LEV-4816MCL24-R | <b>\$989</b>   | \$442 | 79.3  | 12.6 | 15.75 | 23.75 | 47.75 |
| LEV-4824MCL24-R | <b>\$1,385</b> | \$544 | 100.6 | 18.1 | 23.75 | 23.75 | 47.75 |
| LEV-5816MCL24-R | <b>\$1,138</b> | \$586 | 92.9  | 15.2 | 15.75 | 23.75 | 57.5  |
| LEV-5824MCL24-R | <b>\$1,535</b> | \$671 | 117.4 | 21.9 | 23.75 | 23.75 | 57.5  |

- TO ADD BOOTSHelf, ADD **-BS** TO SKU. UP-CHARGES APPLY SEE [LEV-5](#)
- LOCKING

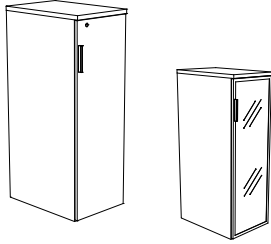

LEV-4816MCL24-R  
LEV-4816MCL24-R-AGD

**MID-HEIGHT CLOSET CABINET W/ STORAGE RISER**

INCLUDES COAT ROD. OPTIONAL BOOT SHELF AVAILABLE. LOCKING.

HINGED LEFT

|                    |                |       |       |      |       |       |       |
|--------------------|----------------|-------|-------|------|-------|-------|-------|
| LEV-5516MCL24-L-SR | <b>\$1,047</b> | \$442 | 92.5  | 14.4 | 15.75 | 23.75 | 54.75 |
| LEV-5524MCL24-L-SR | <b>\$1,443</b> | \$544 | 113.8 | 20.8 | 23.75 | 23.75 | 54.75 |

HINGED RIGHT

|                    |                |       |       |      |       |       |       |
|--------------------|----------------|-------|-------|------|-------|-------|-------|
| LEV-5516MCL24-R-SR | <b>\$1,047</b> | \$442 | 92.5  | 14.4 | 15.75 | 23.75 | 54.75 |
| LEV-5524MCL24-R-SR | <b>\$1,443</b> | \$544 | 113.8 | 20.8 | 23.75 | 23.75 | 54.75 |

- TO ADD BOOTSHelf, ADD **-BS** TO SKU. UP-CHARGES APPLY SEE [LEV-5](#)
- LOCKING

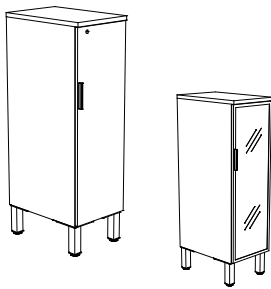

LEV-4816MCL24-R  
LEV-4816MCL24-R-AGD

**MID-HEIGHT WARDROBE STORAGE**

CABINET/FILE WARDROBE LEFT

|                 |                |       |     |      |       |       |       |
|-----------------|----------------|-------|-----|------|-------|-------|-------|
| LEV-4824CFWL-24 | <b>\$1,594</b> | \$778 | 190 | 18.1 | 23.75 | 23.75 | 47.75 |
| LEV-5824CFWL-24 | <b>\$1,813</b> | \$898 | 202 | 21.9 | 23.75 | 23.75 | 57.5  |

CABINET/FILE WARDROBE RIGHT

|                 |                |       |     |      |       |       |       |
|-----------------|----------------|-------|-----|------|-------|-------|-------|
| LEV-4824CFWR-24 | <b>\$1,594</b> | \$778 | 190 | 18.1 | 23.75 | 23.75 | 47.75 |
| LEV-5824CFWR-24 | <b>\$1,813</b> | \$898 | 202 | 21.9 | 23.75 | 23.75 | 57.5  |

- TO ADD BOOTSHelf, ADD **-BS** TO SKU. UP-CHARGES APPLY SEE [LEV-5](#)
- LOCKING FILE DRAWER & WARDROBE, OPTIONAL LOCK ON CABINET DOOR SEE [LEV-6](#)

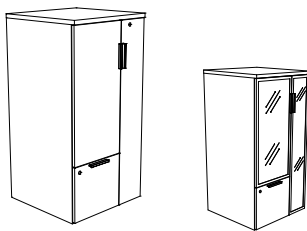

LEV-4824CFWR-24  
LEV-4824CFWR-24-AGD

**MID-HEIGHT WARDROBE STORAGE W/ STORAGE RISER**

CABINET/FILE WARDROBE LEFT

|                    |                |       |     |      |       |       |       |
|--------------------|----------------|-------|-----|------|-------|-------|-------|
| LEV-5524CFWL-24-SR | <b>\$1,652</b> | \$778 | 190 | 20.8 | 23.75 | 23.75 | 54.75 |
|--------------------|----------------|-------|-----|------|-------|-------|-------|

CABINET/FILE WARDROBE RIGHT

|                    |                |       |     |      |       |       |       |
|--------------------|----------------|-------|-----|------|-------|-------|-------|
| LEV-5524CFWR-24-SR | <b>\$1,652</b> | \$778 | 190 | 20.8 | 23.75 | 23.75 | 54.75 |
|--------------------|----------------|-------|-----|------|-------|-------|-------|

- TO ADD BOOTSHelf, ADD **-BS** TO SKU. UP-CHARGES APPLY SEE [LEV-5](#)
- LOCKING FILE DRAWER & WARDROBE, OPTIONAL LOCK ON CABINET DOOR SEE [LEV-6](#)

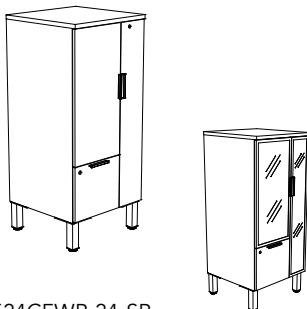

LEV-5524CFWR-24-SR  
LEV-5524CFWR-24-SR-AGD

**LEVELS SERIES**  
**MID-HEIGHT STORAGE CABINETS**

| MODEL | LIST     | *AGD | WEIGHT | CUBE            | W  | D  | H  |
|-------|----------|------|--------|-----------------|----|----|----|
|       | UPCHARGE |      | LBS    | FT <sup>3</sup> | IN | IN | IN |

**MID-HEIGHT WARDROBE STORAGE**

CABINET/FILE/FILE/WARDROBE LEFT

|                  |                |              |     |      |       |       |       |
|------------------|----------------|--------------|-----|------|-------|-------|-------|
| LEV-4824CFFWL-24 | <b>\$1,650</b> | <i>\$544</i> | 190 | 18.1 | 23.75 | 23.75 | 47.75 |
| LEV-5824CFFWL-24 | <b>\$1,870</b> | <i>\$671</i> | 225 | 21.9 | 23.75 | 23.75 | 57.5  |

CABINET/FILE/FILE/WARDROBE RIGHT

|                  |                |              |     |      |       |       |       |
|------------------|----------------|--------------|-----|------|-------|-------|-------|
| LEV-4824CFFWR-24 | <b>\$1,650</b> | <i>\$544</i> | 190 | 18.1 | 23.75 | 23.75 | 47.75 |
| LEV-5824CFFWR-24 | <b>\$1,870</b> | <i>\$671</i> | 225 | 21.9 | 23.75 | 23.75 | 57.5  |

- TO ADD BOOTSHelf, ADD **-BS** TO SKU. UP-CHARGES APPLY SEE [LEV-5](#)
- LOCKING FILE DRAWERS & WARDROBE, OPTIONAL LOCK ON CABINET DOOR SEE [LEV-6](#)

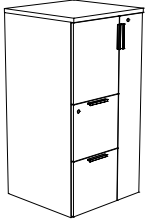

LEV-4824CFFWR-24  
 LEV-4824CFFWR-24-AGD

**MID-HEIGHT WARDROBE STORAGE W/ STORAGE RISER**

CABINET/FILE WARDROBE LEFT

|                     |                |              |     |      |       |       |       |
|---------------------|----------------|--------------|-----|------|-------|-------|-------|
| LEV-5524CFFWL-24-SR | <b>\$1,708</b> | <i>\$544</i> | 190 | 20.8 | 23.75 | 23.75 | 54.75 |
|---------------------|----------------|--------------|-----|------|-------|-------|-------|

CABINET/FILE WARDROBE RIGHT

|                     |                |              |     |      |       |       |       |
|---------------------|----------------|--------------|-----|------|-------|-------|-------|
| LEV-5524CFFWR-24-SR | <b>\$1,708</b> | <i>\$544</i> | 190 | 20.8 | 23.75 | 23.75 | 54.75 |
|---------------------|----------------|--------------|-----|------|-------|-------|-------|

- TO ADD BOOTSHelf, ADD **-BS** TO SKU. UP-CHARGES APPLY SEE [LEV-5](#)
- LOCKING FILE DRAWERS & WARDROBE, OPTIONAL LOCK ON CABINET DOOR SEE [LEV-6](#)

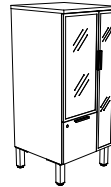

LEV-5524CFFWR-24-SR  
 LEV-5524CFFWR-24-SR-AGD

**MID-HEIGHT WARDROBE STORAGE**

CABINET/BOX/BOX/FILE WARDROBE LEFT

|                  |                |              |     |      |       |       |       |
|------------------|----------------|--------------|-----|------|-------|-------|-------|
| LEV-4824CUFWL-24 | <b>\$1,658</b> | <i>\$544</i> | 190 | 18.1 | 23.75 | 23.75 | 47.75 |
| LEV-5824CUFWL-24 | <b>\$1,877</b> | <i>\$671</i> | 225 | 21.9 | 23.75 | 23.75 | 57.5  |

CABINET/BOX/BOX/FILE WARDROBE RIGHT

|                  |                |              |     |      |       |       |       |
|------------------|----------------|--------------|-----|------|-------|-------|-------|
| LEV-4824CUFWR-24 | <b>\$1,658</b> | <i>\$544</i> | 190 | 18.1 | 23.75 | 23.75 | 47.75 |
| LEV-5824CUFWR-24 | <b>\$1,877</b> | <i>\$671</i> | 225 | 21.9 | 23.75 | 23.75 | 57.5  |

- TO ADD BOOTSHelf, ADD **-BS** TO SKU. UP-CHARGES APPLY SEE [LEV-5](#)
- LOCKING DRAWERS & WARDROBE, OPTIONAL LOCK ON CABINET DOOR SEE [LEV-6](#)



LEV-4824CUFWR-24  
 LEV-4824CUFWR-24-AGD

**MID-HEIGHT WARDROBE STORAGE W/ STORAGE RISER**

CABINET/FILE WARDROBE LEFT

|                     |                |              |     |      |       |       |       |
|---------------------|----------------|--------------|-----|------|-------|-------|-------|
| LEV-5524CUFWL-24-SR | <b>\$1,716</b> | <i>\$544</i> | 190 | 20.8 | 23.75 | 23.75 | 54.75 |
|---------------------|----------------|--------------|-----|------|-------|-------|-------|

CABINET/FILE WARDROBE RIGHT

|                     |                |              |     |      |       |       |       |
|---------------------|----------------|--------------|-----|------|-------|-------|-------|
| LEV-5524CUFWR-24-SR | <b>\$1,716</b> | <i>\$544</i> | 190 | 20.8 | 23.75 | 23.75 | 54.75 |
|---------------------|----------------|--------------|-----|------|-------|-------|-------|

- TO ADD BOOTSHelf, ADD **-BS** TO SKU. UP-CHARGES APPLY SEE [LEV-5](#)
- LOCKING DRAWERS & WARDROBE, OPTIONAL LOCK ON CABINET DOOR SEE [LEV-6](#)



LEV-5524CUFWR-24-SR  
 LEV-5524CUFWR-24-SR-AGD

| MODEL | LIST | *AGD     | WEIGHT | CUBE            | W  | D  | H  |
|-------|------|----------|--------|-----------------|----|----|----|
|       |      | UPCHARGE | LBS    | FT <sup>3</sup> | IN | IN | IN |

**MID-HEIGHT WARDROBE STORAGE**

CABINET/WARDROBE LEFT

|                       |                |              |            |             |              |              |              |
|-----------------------|----------------|--------------|------------|-------------|--------------|--------------|--------------|
| <b>LEV-4824CWL-24</b> | <b>\$1,551</b> | <i>\$778</i> | <b>150</b> | <b>18.1</b> | <b>23.75</b> | <b>23.75</b> | <b>47.75</b> |
| <b>LEV-5824CWL-24</b> | <b>\$1,770</b> | <i>\$898</i> | <b>200</b> | <b>21.9</b> | <b>23.75</b> | <b>23.75</b> | <b>57.5</b>  |

CABINET/WARDROBE RIGHT

|                       |                |              |            |             |              |              |              |
|-----------------------|----------------|--------------|------------|-------------|--------------|--------------|--------------|
| <b>LEV-4824CWR-24</b> | <b>\$1,551</b> | <i>\$778</i> | <b>150</b> | <b>18.1</b> | <b>23.75</b> | <b>23.75</b> | <b>47.75</b> |
| <b>LEV-5824CWR-24</b> | <b>\$1,770</b> | <i>\$898</i> | <b>200</b> | <b>21.9</b> | <b>23.75</b> | <b>23.75</b> | <b>57.5</b>  |

- TO ADD BOOTSHELF, ADD **-BS** TO SKU. UP-CHARGES APPLY SEE [LEV-5](#)
- LOCKING WARDROBE & CABINET

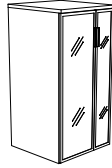
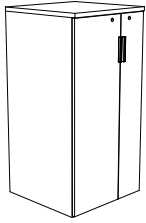

LEV-4824CWR-24  
LEV-4824CWR-24-AGD

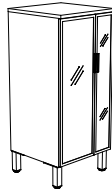
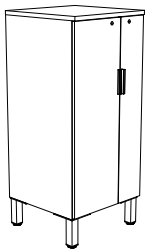

LEV-5524CWR-24-SR  
LEV-5524CWR-24-SR-AGD

**MID-HEIGHT WARDROBE STORAGE W/ STORAGE RISER**

CABINET/WARDROBE LEFT

|                          |                |              |            |             |              |              |              |
|--------------------------|----------------|--------------|------------|-------------|--------------|--------------|--------------|
| <b>LEV-5524CWL-24-SR</b> | <b>\$1,609</b> | <i>\$778</i> | <b>190</b> | <b>20.8</b> | <b>23.75</b> | <b>23.75</b> | <b>54.75</b> |
|--------------------------|----------------|--------------|------------|-------------|--------------|--------------|--------------|

CABINET/WARDROBE RIGHT

|                          |                |              |            |             |              |              |              |
|--------------------------|----------------|--------------|------------|-------------|--------------|--------------|--------------|
| <b>LEV-5524CWR-24-SR</b> | <b>\$1,609</b> | <i>\$778</i> | <b>190</b> | <b>20.8</b> | <b>23.75</b> | <b>23.75</b> | <b>54.75</b> |
|--------------------------|----------------|--------------|------------|-------------|--------------|--------------|--------------|

- TO ADD BOOTSHELF, ADD **-BS** TO SKU. UP-CHARGES APPLY SEE [LEV-5](#)
- LOCKING WARDROBE & CABINET

**MID-HEIGHT OPEN WARDROBE STORAGE**

OPEN SHELF/FILE/WARDROBE LEFT

|                        |                |              |            |             |              |              |              |
|------------------------|----------------|--------------|------------|-------------|--------------|--------------|--------------|
| <b>LEV-4824OFWL-24</b> | <b>\$1,562</b> | <i>\$544</i> | <b>162</b> | <b>18.1</b> | <b>23.75</b> | <b>23.75</b> | <b>47.75</b> |
| <b>LEV-5824OFWL-24</b> | <b>\$1,613</b> | <i>\$575</i> | <b>200</b> | <b>21.9</b> | <b>23.75</b> | <b>23.75</b> | <b>57.5</b>  |

OPEN SHELF/FILE/WARDROBE RIGHT

|                        |                |              |            |             |              |              |              |
|------------------------|----------------|--------------|------------|-------------|--------------|--------------|--------------|
| <b>LEV-4824OFWR-24</b> | <b>\$1,562</b> | <i>\$544</i> | <b>162</b> | <b>18.1</b> | <b>23.75</b> | <b>23.75</b> | <b>47.75</b> |
| <b>LEV-5824OFWR-24</b> | <b>\$1,613</b> | <i>\$575</i> | <b>200</b> | <b>21.9</b> | <b>23.75</b> | <b>23.75</b> | <b>57.5</b>  |

- TO ADD BOOTSHELF, ADD **-BS** TO SKU. UP-CHARGES APPLY SEE [LEV-5](#)
- LOCKING DRAWER & WARDROBE



LEV-4824OFWR-24  
LEV-4824OFWR-24-AGD



LEV-5524OFWR-24-SR  
LEV-5524OFWR-24-SR-AGD

**MID-HEIGHT OPEN WARDROBE STORAGE W/ STORAGE RISER**

OPEN SHELF/FILE/WARDROBE LEFT

|                           |                |              |            |             |              |              |              |
|---------------------------|----------------|--------------|------------|-------------|--------------|--------------|--------------|
| <b>LEV-5524OFWL-24-SR</b> | <b>\$1,620</b> | <i>\$544</i> | <b>190</b> | <b>20.8</b> | <b>23.75</b> | <b>23.75</b> | <b>54.75</b> |
|---------------------------|----------------|--------------|------------|-------------|--------------|--------------|--------------|

OPEN SHELF/FILE/WARDROBE RIGHT

|                           |                |              |            |             |              |              |              |
|---------------------------|----------------|--------------|------------|-------------|--------------|--------------|--------------|
| <b>LEV-5524OFWR-24-SR</b> | <b>\$1,620</b> | <i>\$544</i> | <b>190</b> | <b>20.8</b> | <b>23.75</b> | <b>23.75</b> | <b>54.75</b> |
|---------------------------|----------------|--------------|------------|-------------|--------------|--------------|--------------|

- TO ADD BOOTSHELF, ADD **-BS** TO SKU. UP-CHARGES APPLY SEE [LEV-5](#)
- LOCKING DRAWER & WARDROBE

# LEVELS SERIES

## MID-HEIGHT STORAGE CABINETS

| MODEL | LIST     | *AGD | WEIGHT | CUBE            | W  | D  | H  |
|-------|----------|------|--------|-----------------|----|----|----|
|       | UPCHARGE |      | LBS    | FT <sup>3</sup> | IN | IN | IN |



LEV-4824OFFWR-24  
LEV-4824OFFWR-24-AGD

### MID-HEIGHT OPEN WARDROBE STORAGE

OPEN SHELF/FILE/FILE/WARDROBE LEFT

|                  |                |              |     |      |       |       |       |
|------------------|----------------|--------------|-----|------|-------|-------|-------|
| LEV-4824OFFWL-24 | <b>\$1,613</b> | <i>\$544</i> | 189 | 16.9 | 23.75 | 23.75 | 47.75 |
| LEV-5824OFFWL-24 | <b>\$1,832</b> | <i>\$575</i> | 200 | 18.4 | 23.75 | 23.75 | 57.5  |

OPEN SHELF/FILE/FILE/WARDROBE RIGHT

|                  |                |              |     |      |       |       |       |
|------------------|----------------|--------------|-----|------|-------|-------|-------|
| LEV-4824OFFWR-24 | <b>\$1,613</b> | <i>\$544</i> | 189 | 16.9 | 23.75 | 23.75 | 47.75 |
| LEV-5824OFFWR-24 | <b>\$1,832</b> | <i>\$575</i> | 200 | 18.4 | 23.75 | 23.75 | 57.5  |

- TO ADD BOOTSHelf, ADD **-BS** TO SKU. UP-CHARGES APPLY SEE [LEV-5](#)
- LOCKING FILE DRAWERS & WARDROBE

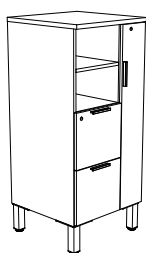

LEV-5524OFFWR-24-SR  
LEV-5524OFFWR-24-SR-AGD

### MID-HEIGHT OPEN WARDROBE STORAGE W/ STORAGE RISER

OPEN SHELF/FILE/FILE/WARDROBE LEFT

|                     |                |              |     |      |       |       |       |
|---------------------|----------------|--------------|-----|------|-------|-------|-------|
| LEV-5524OFFWL-24-SR | <b>\$1,671</b> | <i>\$544</i> | 190 | 16.9 | 23.75 | 23.75 | 54.75 |
|---------------------|----------------|--------------|-----|------|-------|-------|-------|

OPEN SHELF/FILE/FILE/WARDROBE RIGHT

|                     |                |              |     |      |       |       |       |
|---------------------|----------------|--------------|-----|------|-------|-------|-------|
| LEV-5524OFFWR-24-SR | <b>\$1,671</b> | <i>\$544</i> | 190 | 16.9 | 23.75 | 23.75 | 54.75 |
|---------------------|----------------|--------------|-----|------|-------|-------|-------|

- TO ADD BOOTSHelf, ADD **-BS** TO SKU. UP-CHARGES APPLY SEE [LEV-5](#)
- LOCKING FILE DRAWERS & WARDROBE



LEV-4824OUFWL-24  
LEV-4824OUFWL-24-AGD

### MID-HEIGHT OPEN WARDROBE STORAGE

OPEN SHELF/BOX/BOX/FILE/WARDROBE LEFT

|                  |                |              |     |      |       |       |       |
|------------------|----------------|--------------|-----|------|-------|-------|-------|
| LEV-4824OUFWL-24 | <b>\$1,562</b> | <i>\$544</i> | 189 | 16.9 | 23.75 | 23.75 | 47.75 |
| LEV-5824OUFWL-24 | <b>\$1,782</b> | <i>\$575</i> | 200 | 18.4 | 23.75 | 23.75 | 57.5  |

OPEN SHELF/BOX/BOX/FILE/WARDROBE RIGHT

|                  |                |              |     |      |       |       |       |
|------------------|----------------|--------------|-----|------|-------|-------|-------|
| LEV-4824OUFWR-24 | <b>\$1,562</b> | <i>\$544</i> | 189 | 16.9 | 23.75 | 23.75 | 47.75 |
| LEV-5824OUFWR-24 | <b>\$1,782</b> | <i>\$575</i> | 200 | 18.4 | 23.75 | 23.75 | 57.5  |

- TO ADD BOOTSHelf, ADD **-BS** TO SKU. UP-CHARGES APPLY SEE [LEV-5](#)
- LOCKING DRAWERS & WARDROBE



LEV-5524OUFWL-24-SR  
LEV-5524OUFWL-24-SR-AGD

### MID-HEIGHT OPEN WARDROBE STORAGE W/ STORAGE RISER

OPEN SHELF/BOX/BOX/FILE/WARDROBE LEFT

|                     |                |              |     |      |       |       |       |
|---------------------|----------------|--------------|-----|------|-------|-------|-------|
| LEV-5524OUFWL-24-SR | <b>\$1,620</b> | <i>\$544</i> | 190 | 16.9 | 23.75 | 23.75 | 54.75 |
|---------------------|----------------|--------------|-----|------|-------|-------|-------|

OPEN SHELF/BOX/BOX/FILE/WARDROBE RIGHT

|                     |                |              |     |      |       |       |       |
|---------------------|----------------|--------------|-----|------|-------|-------|-------|
| LEV-5524OUFWR-24-SR | <b>\$1,620</b> | <i>\$544</i> | 190 | 16.9 | 23.75 | 23.75 | 54.75 |
|---------------------|----------------|--------------|-----|------|-------|-------|-------|

- TO ADD BOOTSHelf, ADD **-BS** TO SKU. UP-CHARGES APPLY SEE [LEV-5](#)
- LOCKING DRAWERS & WARDROBE



| MODEL | LIST | *AGD      | WEIGHT | CUBE            | W  | D  | H  |
|-------|------|-----------|--------|-----------------|----|----|----|
|       |      | UP CHARGE | LBS    | FT <sup>3</sup> | IN | IN | IN |

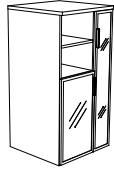
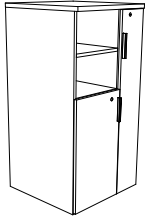

LEV-4824OCWR-24  
LEV-4824OCWR-24-AGD

**WARDROBE STORAGE CABINETS**

OPEN SHELF/CABINET/WARDROBE LEFT

|                 |                |       |     |      |       |       |       |
|-----------------|----------------|-------|-----|------|-------|-------|-------|
| LEV-4824OCWL-24 | <b>\$1,451</b> | \$622 | 166 | 16.9 | 23.75 | 23.75 | 47.75 |
| LEV-5824OCWL-24 | <b>\$1,519</b> | \$646 | 200 | 18.4 | 23.75 | 23.75 | 57.5  |

OPEN SHELF/CABINET/WARDROBE RIGHT

|                 |                |       |     |      |       |       |       |
|-----------------|----------------|-------|-----|------|-------|-------|-------|
| LEV-4824OCWR-24 | <b>\$1,451</b> | \$622 | 166 | 16.9 | 23.75 | 23.75 | 47.75 |
| LEV-5824OCWR-24 | <b>\$1,519</b> | \$646 | 200 | 18.4 | 23.75 | 23.75 | 57.5  |

- TO ADD BOOTSHelf, ADD **-BS** TO SKU. UP-CHARGES APPLY SEE [LEV-5](#)
- LOCKING CABINET & WARDROBE

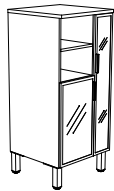
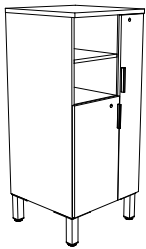

LEV-5524OCWR-24-SR  
LEV-5524OCWR-24-SR-AGD

**WARDROBE STORAGE CABINETS W/ STORAGE RISER**

OPEN SHELF/CABINET/WARDROBE LEFT

|                    |                |       |     |      |       |       |       |
|--------------------|----------------|-------|-----|------|-------|-------|-------|
| LEV-5524OCWL-24-SR | <b>\$1,509</b> | \$622 | 166 | 16.9 | 23.75 | 23.75 | 54.75 |
|--------------------|----------------|-------|-----|------|-------|-------|-------|

OPEN SHELF/CABINET/WARDROBE RIGHT

|                    |                |       |     |      |       |       |       |
|--------------------|----------------|-------|-----|------|-------|-------|-------|
| LEV-5524OCWR-24-SR | <b>\$1,509</b> | \$622 | 166 | 16.9 | 23.75 | 23.75 | 54.75 |
|--------------------|----------------|-------|-----|------|-------|-------|-------|

- TO ADD BOOTSHelf, ADD **-BS** TO SKU. UP-CHARGES APPLY SEE [LEV-5](#)
- LOCKING CABINET & WARDROBE

**LEVELS SERIES**  
**TALL STORAGE CABINETS**

| MODEL | LIST     | *AGD | WEIGHT | CUBE            | W  | D  | H  |
|-------|----------|------|--------|-----------------|----|----|----|
|       | UPCHARGE |      | LBS    | FT <sup>3</sup> | IN | IN | IN |

**\*OPTIONAL AGD (ALUMINIUM GLAZED DOORS) DOORS**

- AGD DOORS INCLUDE SILVER FINISH BAR HANDLES
- THE PRICE SHOWN FOR AGD DOORS IS AN UPCHARGE THAT MUST BE ADDED TO THE BASE PRICE OF THE UNIT IT GOES ON

AGD FINISHES CLEAR (CL), FROSTED (FR) OR BRONZE (BR)

**TALL CABINET**

20" DEEP 2 FIXED SHELVES & 2 ADJUSTABLE SHELVES

|              |                |                |            |           |             |              |             |
|--------------|----------------|----------------|------------|-----------|-------------|--------------|-------------|
| LEV-6536C-20 | <b>\$1,898</b> | <i>\$1,130</i> | <b>278</b> | <b>32</b> | <b>35.5</b> | <b>19.75</b> | <b>64.5</b> |
| LEV-7236C-20 | <b>\$2,094</b> | <i>\$1,215</i> | <b>330</b> | <b>36</b> | <b>35.5</b> | <b>19.75</b> | <b>71.5</b> |

20" DEEP 3 FIXED SHELVES & 2 ADJUSTABLE SHELVES

|              |                |                |            |           |             |              |              |
|--------------|----------------|----------------|------------|-----------|-------------|--------------|--------------|
| LEV-7736C-20 | <b>\$2,211</b> | <i>\$1,249</i> | <b>310</b> | <b>33</b> | <b>35.5</b> | <b>19.75</b> | <b>76.25</b> |
| LEV-8436C-20 | <b>\$2,349</b> | <i>\$1,262</i> | <b>310</b> | <b>42</b> | <b>35.5</b> | <b>19.75</b> | <b>83.25</b> |

24" DEEP 2 FIXED SHELVES & 2 ADJUSTABLE SHELVES

|              |                |                |            |           |             |              |             |
|--------------|----------------|----------------|------------|-----------|-------------|--------------|-------------|
| LEV-6536C-24 | <b>\$2,101</b> | <i>\$1,130</i> | <b>290</b> | <b>39</b> | <b>35.5</b> | <b>23.75</b> | <b>64.5</b> |
| LEV-7236C-24 | <b>\$2,254</b> | <i>\$1,215</i> | <b>316</b> | <b>43</b> | <b>35.5</b> | <b>23.75</b> | <b>71.5</b> |

24" DEEP 3 FIXED SHELVES & 2 ADJUSTABLE SHELVES

|              |                |                |            |           |             |              |              |
|--------------|----------------|----------------|------------|-----------|-------------|--------------|--------------|
| LEV-7736C-24 | <b>\$2,349</b> | <i>\$1,249</i> | <b>323</b> | <b>39</b> | <b>35.5</b> | <b>23.75</b> | <b>76.25</b> |
| LEV-8436C-24 | <b>\$2,494</b> | <i>\$1,262</i> | <b>334</b> | <b>50</b> | <b>35.5</b> | <b>23.75</b> | <b>83.25</b> |

- 30" WIDE UNIT AVAILABLE. CHANGE SKU FROM 36" TO 30" & USE SAME PRICING
- LOCKING CABINET

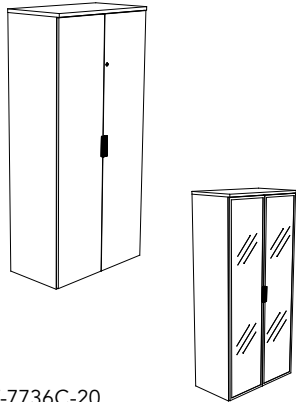

LEV-7736C-20  
LEV-7736C-20-AGD

**TALL CABINET W/ STORAGE RISER**

20" DEEP 1 FIXED SHELF & 3 ADJUSTABLE SHELVES

|                 |                |                |            |             |             |              |             |
|-----------------|----------------|----------------|------------|-------------|-------------|--------------|-------------|
| LEV-6536C-20-SR | <b>\$1,685</b> | <i>\$1,047</i> | <b>278</b> | <b>30.3</b> | <b>35.5</b> | <b>19.75</b> | <b>64.5</b> |
| LEV-7236C-20-SR | <b>\$1,956</b> | <i>\$1,130</i> | <b>310</b> | <b>33.5</b> | <b>35.5</b> | <b>19.75</b> | <b>71.5</b> |

20" DEEP 3 FIXED SHELVES & 2 ADJUSTABLE SHELVES

|                 |                |                |            |             |             |              |              |
|-----------------|----------------|----------------|------------|-------------|-------------|--------------|--------------|
| LEV-7736C-20-SR | <b>\$2,152</b> | <i>\$1,215</i> | <b>330</b> | <b>35.8</b> | <b>35.5</b> | <b>19.75</b> | <b>76.25</b> |
| LEV-8436C-20-SR | <b>\$2,269</b> | <i>\$1,249</i> | <b>310</b> | <b>39.1</b> | <b>35.5</b> | <b>19.75</b> | <b>83.25</b> |

24" DEEP 1 FIXED SHELF & 3 ADJUSTABLE SHELVES

|                 |                |                |            |             |             |              |             |
|-----------------|----------------|----------------|------------|-------------|-------------|--------------|-------------|
| LEV-6536C-24-SR | <b>\$1,810</b> | <i>\$1,047</i> | <b>290</b> | <b>35.8</b> | <b>35.5</b> | <b>23.75</b> | <b>64.5</b> |
| LEV-7236C-24-SR | <b>\$2,159</b> | <i>\$1,130</i> | <b>316</b> | <b>39.6</b> | <b>35.5</b> | <b>23.75</b> | <b>71.5</b> |

24" DEEP 3 FIXED SHELVES & 2 ADJUSTABLE SHELVES

|                 |                |                |            |             |             |              |              |
|-----------------|----------------|----------------|------------|-------------|-------------|--------------|--------------|
| LEV-7736C-24-SR | <b>\$2,312</b> | <i>\$1,215</i> | <b>323</b> | <b>42.3</b> | <b>35.5</b> | <b>23.75</b> | <b>76.25</b> |
| LEV-8436C-24-SR | <b>\$2,407</b> | <i>\$1,249</i> | <b>334</b> | <b>46.2</b> | <b>35.5</b> | <b>23.75</b> | <b>83.25</b> |

- 30" WIDE UNIT AVAILABLE. CHANGE SKU FROM 36" TO 30" & USE SAME PRICING
- LOCKING CABINET

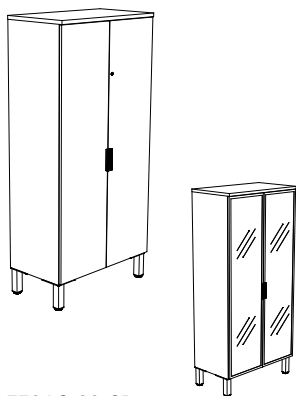

LEV-7736C-20-SR  
LEV-7736C-20-SR-AGD

| MODEL | LIST | *AGD     | WEIGHT | CUBE            | W  | D  | H  |
|-------|------|----------|--------|-----------------|----|----|----|
|       |      | UPCHARGE | LBS    | FT <sup>3</sup> | IN | IN | IN |

**WARDROBE CABINET**

2 FIXED SHELVES & 2 ADJUSTABLE SHELVES

|               |                |                |     |    |      |       |      |
|---------------|----------------|----------------|-----|----|------|-------|------|
| LEV-6536WC-20 | <b>\$2,130</b> | <i>\$1,130</i> | 270 | 32 | 35.5 | 19.75 | 64.5 |
| LEV-6536WC-24 | <b>\$2,183</b> | <i>\$1,130</i> | 280 | 39 | 35.5 | 23.75 | 64.5 |

2 FIXED SHELVES & 3 ADJUSTABLE SHELVES

|               |                |                |     |    |      |       |      |
|---------------|----------------|----------------|-----|----|------|-------|------|
| LEV-7236WC-20 | <b>\$2,292</b> | <i>\$1,215</i> | 320 | 36 | 35.5 | 19.75 | 71.5 |
| LEV-7236WC-24 | <b>\$2,359</b> | <i>\$1,215</i> | 300 | 43 | 35.5 | 23.75 | 71.5 |

3 FIXED SHELVES & 2 ADJUSTABLE SHELVES

|               |                |                |     |    |      |       |       |
|---------------|----------------|----------------|-----|----|------|-------|-------|
| LEV-7736WC-20 | <b>\$2,359</b> | <i>\$1,249</i> | 305 | 37 | 35.5 | 19.75 | 76.25 |
| LEV-7736WC-24 | <b>\$2,410</b> | <i>\$1,249</i> | 317 | 41 | 35.5 | 23.75 | 76.25 |

3 FIXED SHELVES & 3 ADJUSTABLE SHELVES

|               |                |                |     |    |      |       |       |
|---------------|----------------|----------------|-----|----|------|-------|-------|
| LEV-8436WC-20 | <b>\$2,496</b> | <i>\$1,262</i> | 312 | 42 | 35.5 | 19.75 | 83.25 |
| LEV-8436WC-24 | <b>\$2,548</b> | <i>\$1,262</i> | 330 | 50 | 35.5 | 23.75 | 83.25 |

- FULL HEIGHT WARDROBE WITH HAT SHELF
- LOCKING CABINET
- COAT ROD FOR 24" DEEP OR THREE COAT HOOKS ON THE 20" DEEP UNITS

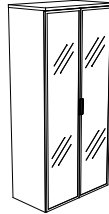
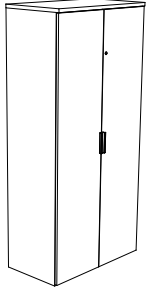

LEV-7736WC-20  
LEV-7736WC-20-AGD

**WARDROBE CABINET W/ STORAGE RISER**

1 FIXED SHELF & 3 ADJUSTABLE SHELVES

|                  |                |                |     |      |      |       |      |
|------------------|----------------|----------------|-----|------|------|-------|------|
| LEV-6536WC-20-SR | <b>\$1,968</b> | <i>\$1,047</i> | 270 | 30.3 | 35.5 | 19.75 | 64.5 |
| LEV-6536WC-24-SR | <b>\$2,008</b> | <i>\$1,047</i> | 280 | 35.8 | 35.5 | 23.75 | 64.5 |

2 FIXED SHELVES & 2 ADJUSTABLE SHELVES

|                  |                |                |     |      |      |       |      |
|------------------|----------------|----------------|-----|------|------|-------|------|
| LEV-7236WC-20-SR | <b>\$2,188</b> | <i>\$1,130</i> | 300 | 33.5 | 35.5 | 19.75 | 71.5 |
| LEV-7236WC-24-SR | <b>\$2,241</b> | <i>\$1,130</i> | 320 | 39.6 | 35.5 | 23.75 | 71.5 |

3 FIXED SHELVES & 2 ADJUSTABLE SHELVES

|                  |                |                |     |      |      |       |       |
|------------------|----------------|----------------|-----|------|------|-------|-------|
| LEV-7736WC-20-SR | <b>\$2,350</b> | <i>\$1,215</i> | 305 | 35.8 | 35.5 | 19.75 | 76.25 |
| LEV-7736WC-24-SR | <b>\$2,417</b> | <i>\$1,215</i> | 317 | 42.3 | 35.5 | 23.75 | 76.25 |

3 FIXED SHELVES & 2 ADJUSTABLE SHELVES

|                  |                |                |     |      |      |       |       |
|------------------|----------------|----------------|-----|------|------|-------|-------|
| LEV-8436WC-20-SR | <b>\$2,417</b> | <i>\$1,249</i> | 312 | 39.1 | 35.5 | 19.75 | 83.25 |
| LEV-8436WC-24-SR | <b>\$2,468</b> | <i>\$1,249</i> | 330 | 46.2 | 35.5 | 23.75 | 83.25 |

- FULL HEIGHT WARDROBE WITH HAT SHELF
- LOCKING CABINET
- COAT ROD FOR 24" DEEP OR THREE COAT HOOKS ON THE 20" DEEP UNITS

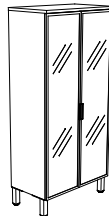
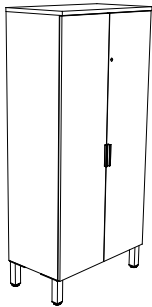

LEV-7736WC-20-SR  
LEV-7736WC-20-SR-AGD

# LEVELS SERIES

## TALL STORAGE CABINETS

| MODEL | LIST | *AGD     | WEIGHT | CUBE            | W  | D  | H  |
|-------|------|----------|--------|-----------------|----|----|----|
|       |      | UPCHARGE | LBS    | FT <sup>3</sup> | IN | IN | IN |

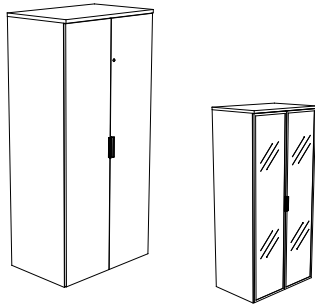

LEV-7736CLC-24  
LEV-7736CLC-24-AGD

### DOUBLE DOOR CLOSET CABINET

INCLUDES HAT SHELF & COAT ROD

|                |                |                |     |    |      |       |       |
|----------------|----------------|----------------|-----|----|------|-------|-------|
| LEV-6536CLC-24 | <b>\$1,909</b> | <i>\$1,130</i> | 270 | 32 | 35.5 | 23.75 | 64.5  |
| LEV-7236CLC-24 | <b>\$2,106</b> | <i>\$1,215</i> | 325 | 36 | 35.5 | 23.75 | 71.5  |
| LEV-7736CLC-24 | <b>\$2,223</b> | <i>\$1,249</i> | 330 | 37 | 35.5 | 23.75 | 76.25 |
| LEV-8436CLC-24 | <b>\$2,361</b> | <i>\$1,262</i> | 339 | 42 | 35.5 | 23.75 | 83.25 |

- LOCKING CABINET
- FOR 20" DEPTH CABINETS, CHANGE -24 TO -20 AND USE THE SAME PRICE
- COAT HOOKS REPLACE THE COAT ROD IN 20" DEEP UNITS
- TO ADD BOOTSHLF, ADD **-BS** TO SKU. UP-CHARGES APPLY SEE [LEV-5](#)

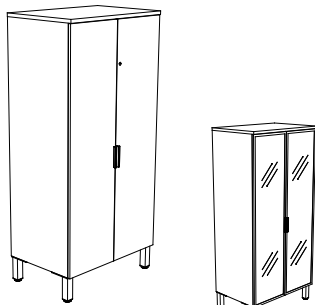

LEV-7736CLC-24-SR  
LEV-7736CLC-24-SR-AGD

### DOUBLE DOOR CLOSET CABINET W/ STORAGE RISER

INCLUDES HAT SHELF & COAT ROD

|                   |                |                |     |    |      |       |       |
|-------------------|----------------|----------------|-----|----|------|-------|-------|
| LEV-6536CLC-24-SR | <b>\$1,788</b> | <i>\$1,047</i> | 270 | 32 | 35.5 | 23.75 | 64.5  |
| LEV-7236CLC-24-SR | <b>\$1,967</b> | <i>\$1,130</i> | 325 | 36 | 35.5 | 23.75 | 71.5  |
| LEV-7736CLC-24-SR | <b>\$2,164</b> | <i>\$1,215</i> | 330 | 37 | 35.5 | 23.75 | 76.25 |
| LEV-8436CLC-24-SR | <b>\$2,281</b> | <i>\$1,249</i> | 339 | 42 | 35.5 | 23.75 | 83.25 |

- LOCKING CABINET
- FOR 20" DEPTH CABINETS, CHANGE -24 TO -20 AND USE THE SAME PRICE
- COAT HOOKS REPLACE THE COAT ROD IN 20" DEEP UNITS
- TO ADD BOOTSHLF, ADD **-BS** TO SKU. UP-CHARGES APPLY SEE [LEV-5](#)

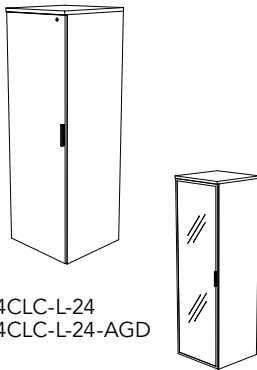

LEV-7224CLC-L-24  
LEV-7224CLC-L-24-AGD

### SINGLE DOOR CLOSET CABINET

HINGED LEFT

|                  |                |              |     |    |       |       |       |
|------------------|----------------|--------------|-----|----|-------|-------|-------|
| LEV-6524CLC-L-24 | <b>\$1,862</b> | <i>\$631</i> | 200 | 26 | 23.75 | 23.75 | 64.5  |
| LEV-7224CLC-L-24 | <b>\$1,991</b> | <i>\$671</i> | 215 | 27 | 23.75 | 23.75 | 71.5  |
| LEV-7724CLC-L-24 | <b>\$2,056</b> | <i>\$729</i> | 224 | 28 | 23.75 | 23.75 | 76.25 |
| LEV-8424CLC-L-24 | <b>\$2,194</b> | <i>\$829</i> | 238 | 32 | 23.75 | 23.75 | 83.25 |

- INCLUDES HAT SHELF & COAT ROD, OPTIONAL BOOT SHELF AVAILABLE WITH LOCKING CABINET
- FOR 20" DEPTH CABINETS, CHANGE -24 TO -20 AND USE THE SAME PRICE
- COAT HOOKS REPLACE THE COAT ROD IN 20" DEEP UNITS
- TO ADD BOOTSHLF, ADD **-BS** TO SKU. UP-CHARGES APPLY SEE [LEV-5](#)

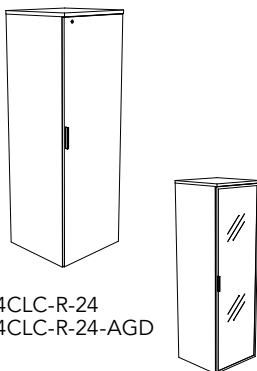

LEV-7224CLC-R-24  
LEV-7224CLC-R-24-AGD

### SINGLE DOOR CLOSET CABINET

HINGED RIGHT

|                  |                |              |     |    |       |       |       |
|------------------|----------------|--------------|-----|----|-------|-------|-------|
| LEV-6524CLC-R-24 | <b>\$1,862</b> | <i>\$631</i> | 200 | 26 | 23.75 | 23.75 | 64.5  |
| LEV-7224CLC-R-24 | <b>\$1,991</b> | <i>\$671</i> | 215 | 27 | 23.75 | 23.75 | 71.5  |
| LEV-7724CLC-R-24 | <b>\$2,056</b> | <i>\$729</i> | 224 | 28 | 23.75 | 23.75 | 76.25 |
| LEV-8424CLC-R-24 | <b>\$2,194</b> | <i>\$829</i> | 238 | 32 | 23.75 | 23.75 | 83.25 |

- INCLUDES HAT SHELF & COAT ROD, OPTIONAL BOOT SHELF AVAILABLE WITH LOCKING CABINET
- FOR 20" DEPTH CABINETS, CHANGE -24 TO -20 AND USE THE SAME PRICE
- COAT HOOKS REPLACE THE COAT ROD IN 20" DEEP UNITS
- TO ADD BOOTSHLF, ADD **-BS** TO SKU. UP-CHARGES APPLY SEE [LEV-5](#)

| MODEL | LIST     | *AGD | WEIGHT | CUBE            | W  | D  | H  |
|-------|----------|------|--------|-----------------|----|----|----|
|       | UPCHARGE |      | LBS    | FT <sup>3</sup> | IN | IN | IN |

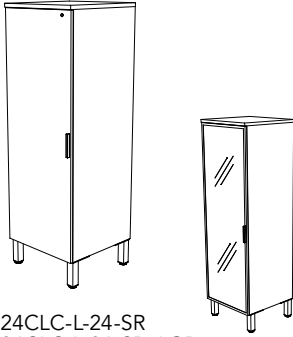

LEV-7224CLC-L-24-SR  
LEV-7224CLC-L-24-SR-AGD

**SINGLE DOOR CLOSET CABINET W/ STORAGE RISER**

HINGED LEFT

|                     |                |       |     |    |       |       |       |
|---------------------|----------------|-------|-----|----|-------|-------|-------|
| LEV-6524CLC-L-24-SR | <b>\$1,739</b> | \$575 | 200 | 26 | 23.75 | 23.75 | 64.5  |
| LEV-7224CLC-L-24-SR | <b>\$1,920</b> | \$631 | 215 | 27 | 23.75 | 23.75 | 71.5  |
| LEV-7724CLC-L-24-SR | <b>\$2,049</b> | \$671 | 224 | 28 | 23.75 | 23.75 | 76.25 |
| LEV-8424CLC-L-24-SR | <b>\$2,114</b> | \$729 | 238 | 32 | 23.75 | 23.75 | 83.25 |

- INCLUDES HAT SHELF & COAT ROD, OPTIONAL BOOT SHELF AVAILABLE WITH LOCKING CABINET
- FOR 20" DEPTH CABINETS, CHANGE -24 TO -20 AND USE THE SAME PRICE
- COAT HOOKS REPLACE THE COAT ROD IN 20" DEEP UNITS
- TO ADD BOOT SHELF, ADD **-BS** TO SKU. UP-CHARGES APPLY SEE [LEV-5](#)

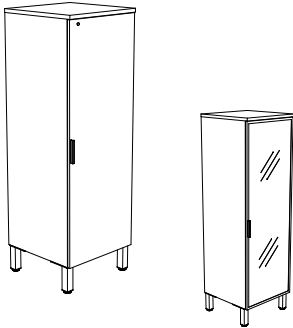

LEV-7224CLC-R-24-SR  
LEV-7224CLC-R-24-SR-AGD

**SINGLE DOOR CLOSET CABINET W/ STORAGE RISER**

HINGED RIGHT

|                     |                |       |     |    |       |       |       |
|---------------------|----------------|-------|-----|----|-------|-------|-------|
| LEV-6524CLC-R-24-SR | <b>\$1,739</b> | \$575 | 200 | 26 | 23.75 | 23.75 | 64.5  |
| LEV-7224CLC-R-24-SR | <b>\$1,920</b> | \$631 | 215 | 27 | 23.75 | 23.75 | 71.5  |
| LEV-7724CLC-R-24-SR | <b>\$2,049</b> | \$671 | 224 | 28 | 23.75 | 23.75 | 76.25 |
| LEV-8424CLC-R-24-SR | <b>\$2,114</b> | \$729 | 238 | 32 | 23.75 | 23.75 | 83.25 |

- INCLUDES HAT SHELF & COAT ROD, OPTIONAL BOOT SHELF AVAILABLE WITH LOCKING CABINET
- FOR 20" DEPTH CABINETS, CHANGE -24 TO -20 AND USE THE SAME PRICE
- COAT HOOKS REPLACE THE COAT ROD IN 20" DEEP UNITS
- TO ADD BOOT SHELF, ADD **-BS** TO SKU. UP-CHARGES APPLY SEE [LEV-5](#)

**\*OPTIONAL AGD (ALUMINIUM GLAZED DOORS) DOORS**

- AGD DOORS INCLUDE SILVER FINISH BAR HANDLES
- THE PRICE SHOWN FOR AGD DOORS IS AN UPCHARGE THAT MUST BE ADDED TO THE BASE PRICE OF THE UNIT IT GOES ON

AGD FINISHES

CLEAR (CL), FROSTED (FR) OR BRONZE (BR)

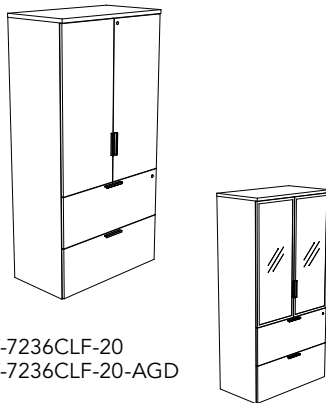

LEV-7236CLF-20  
LEV-7236CLF-20-AGD

**STORAGE CABINET / LATERAL FILE**

1 FIXED SHELF & 1 ADJUSTABLE SHELF

|                |                |       |     |    |      |       |      |
|----------------|----------------|-------|-----|----|------|-------|------|
| LEV-6536CLF-20 | <b>\$2,113</b> | \$769 | 250 | 32 | 35.5 | 19.75 | 64.5 |
| LEV-6536CLF-24 | <b>\$2,312</b> | \$769 | 264 | 39 | 35.5 | 23.75 | 64.5 |

1 FIXED SHELF & 2 ADJUSTABLE SHELVES

|                |                |       |     |    |      |       |      |
|----------------|----------------|-------|-----|----|------|-------|------|
| LEV-7236CLF-20 | <b>\$2,339</b> | \$854 | 302 | 36 | 35.5 | 19.75 | 71.5 |
| LEV-7236CLF-24 | <b>\$2,618</b> | \$854 | 314 | 43 | 35.5 | 23.75 | 71.5 |

2 FIXED SHELVES & 1 ADJUSTABLE SHELF

|                |                |       |     |    |      |       |       |
|----------------|----------------|-------|-----|----|------|-------|-------|
| LEV-7736CLF-20 | <b>\$2,428</b> | \$914 | 312 | 37 | 35.5 | 19.75 | 76.25 |
| LEV-7736CLF-24 | <b>\$2,708</b> | \$914 | 320 | 39 | 35.5 | 23.75 | 76.25 |

2 FIXED SHELVES & 2 ADJUSTABLE SHELVES

|                |                |         |     |    |      |       |       |
|----------------|----------------|---------|-----|----|------|-------|-------|
| LEV-8436CLF-20 | <b>\$2,566</b> | \$1,011 | 326 | 42 | 35.5 | 19.75 | 83.25 |
| LEV-8436CLF-24 | <b>\$2,846</b> | \$1,011 | 337 | 50 | 35.5 | 23.75 | 83.25 |

- LOCKING CABINET & LATERAL FILES

**LEVELS SERIES**  
**TALL STORAGE CABINETS**

| MODEL | LIST     | *AGD | WEIGHT | CUBE            | W  | D  | H  |
|-------|----------|------|--------|-----------------|----|----|----|
|       | UPCHARGE |      | LBS    | FT <sup>3</sup> | IN | IN | IN |

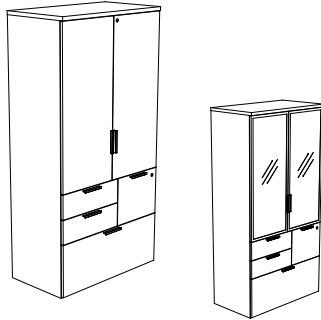

LEV-7236UFL-20  
LEV-7236UFL-20-AGD

**STORAGE CABINET / LATERAL COMBO**

1 FIXED SHELF & 1 ADJUSTABLE SHELF

|                |                |              |     |    |      |       |      |
|----------------|----------------|--------------|-----|----|------|-------|------|
| LEV-6536UFL-20 | <b>\$2,216</b> | <i>\$769</i> | 250 | 32 | 35.5 | 19.75 | 64.5 |
| LEV-6536UFL-24 | <b>\$2,421</b> | <i>\$769</i> | 264 | 39 | 35.5 | 23.75 | 64.5 |

1 FIXED SHELF & 2 ADJUSTABLE SHELVES

|                |                |              |     |    |      |       |      |
|----------------|----------------|--------------|-----|----|------|-------|------|
| LEV-7236UFL-20 | <b>\$2,453</b> | <i>\$854</i> | 302 | 36 | 35.5 | 19.75 | 71.5 |
| LEV-7236UFL-24 | <b>\$2,725</b> | <i>\$854</i> | 314 | 43 | 35.5 | 23.75 | 71.5 |

2 FIXED SHELVES & 1 ADJUSTABLE SHELF

|                |                |              |     |    |      |       |       |
|----------------|----------------|--------------|-----|----|------|-------|-------|
| LEV-7736UFL-20 | <b>\$2,559</b> | <i>\$914</i> | 312 | 37 | 35.5 | 19.75 | 76.25 |
| LEV-7736UFL-24 | <b>\$2,771</b> | <i>\$914</i> | 328 | 39 | 35.5 | 23.75 | 76.25 |

2 FIXED SHELVES & 2 ADJUSTABLE SHELVES

|                |                |                |     |    |      |       |       |
|----------------|----------------|----------------|-----|----|------|-------|-------|
| LEV-8436UFL-20 | <b>\$2,697</b> | <i>\$1,011</i> | 326 | 42 | 35.5 | 19.75 | 83.25 |
| LEV-8436UFL-24 | <b>\$2,908</b> | <i>\$1,011</i> | 337 | 50 | 35.5 | 23.75 | 83.25 |

- LOCKING CABINET
- LOCKING FILE & LATERAL FILE DRAWERS

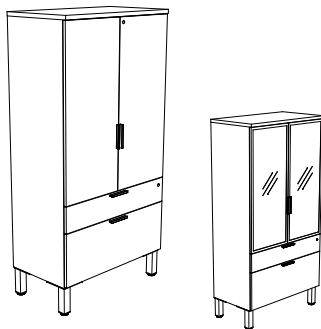

LEV-7236WDLF-20-SR  
LEV-7236WDLF-20-SR-AGD

**STORAGE CABINET / WIDE DRAWER/LATERAL FILE W/ STORAGE RISER**

1 FIXED SHELF & 1 ADJUSTABLE SHELF

|                    |                |              |       |      |      |       |      |
|--------------------|----------------|--------------|-------|------|------|-------|------|
| LEV-6536WDLF-20-SR | <b>\$1,944</b> | <i>\$769</i> | 152.5 | 28.9 | 35.5 | 19.75 | 64.5 |
| LEV-6536WDLF-24-SR | <b>\$2,143</b> | <i>\$769</i> | 166.8 | 34.4 | 35.5 | 23.75 | 64.5 |

1 FIXED SHELF & 2 ADJUSTABLE SHELVES

|                    |                |              |       |      |      |       |      |
|--------------------|----------------|--------------|-------|------|------|-------|------|
| LEV-7236WDLF-20-SR | <b>\$2,172</b> | <i>\$854</i> | 166.1 | 32.1 | 35.5 | 19.75 | 71.5 |
| LEV-7236WDLF-24-SR | <b>\$2,371</b> | <i>\$854</i> | 181.4 | 38.1 | 35.5 | 23.75 | 71.5 |

2 ADJUSTABLE SHELVES & 1 LOCKING FIXED SHELF

|                    |                |              |       |      |      |       |       |
|--------------------|----------------|--------------|-------|------|------|-------|-------|
| LEV-7736WDLF-20-SR | <b>\$2,398</b> | <i>\$914</i> | 175.8 | 34.3 | 35.5 | 19.75 | 76.25 |
| LEV-7736WDLF-24-SR | <b>\$2,677</b> | <i>\$914</i> | 191.8 | 40.7 | 35.5 | 23.75 | 76.25 |

2 LOCKING FIXED SHELVES & 2 ADJUSTABLE SHELVES

|                    |                |                |       |      |      |       |       |
|--------------------|----------------|----------------|-------|------|------|-------|-------|
| LEV-8436WDLF-20-SR | <b>\$2,488</b> | <i>\$1,011</i> | 189.4 | 37.4 | 35.5 | 19.75 | 83.25 |
| LEV-8436WDLF-24-SR | <b>\$2,767</b> | <i>\$1,011</i> | 206.3 | 44.4 | 35.5 | 23.75 | 83.25 |

- LOCKING CABINET & DRAWERS

| MODEL | LIST | *AGD      | WEIGHT | CUBE            | W  | D  | H  |
|-------|------|-----------|--------|-----------------|----|----|----|
|       |      | UP CHARGE | LBS    | FT <sup>3</sup> | IN | IN | IN |

**OPEN WARDROBE STORAGE - OPEN SHELVES/WARDROBE LEFT**

2 FIXED SHELVES & 2 ADJUSTABLE SHELVES

|                |         |       |     |      |       |       |      |
|----------------|---------|-------|-----|------|-------|-------|------|
| LEV-6524OWL-24 | \$1,408 | \$632 | 200 | 26   | 23.75 | 23.75 | 64.5 |
| LEV-6530OWL-24 | \$1,557 | \$671 | 222 | 32.8 | 29.5  | 23.75 | 64.5 |

3 FIXED SHELVES & 2 ADJUSTABLE SHELVES

|                |         |       |     |      |       |       |       |
|----------------|---------|-------|-----|------|-------|-------|-------|
| LEV-7224OWL-24 | \$1,611 | \$700 | 233 | 30   | 23.75 | 23.75 | 71.5  |
| LEV-7230OWL-24 | \$1,754 | \$744 | 225 | 36.3 | 29.5  | 23.75 | 71.5  |
| LEV-7724OWL-24 | \$1,684 | \$729 | 233 | 30   | 23.75 | 23.75 | 76.25 |
| LEV-7730OWL-24 | \$1,866 | \$802 | 241 | 38   | 29.5  | 23.75 | 76.25 |

4 FIXED SHELVES & 2 ADJUSTABLE SHELVES

|                |         |       |     |    |       |       |       |
|----------------|---------|-------|-----|----|-------|-------|-------|
| LEV-8424OWL-24 | \$1,822 | \$829 | 234 | 35 | 23.75 | 23.75 | 83.25 |
| LEV-8430OWL-24 | \$2,002 | \$901 | 262 | 42 | 29.5  | 23.75 | 83.25 |

- INCLUDES COAT ROD & HAT SHELF
- LOCKING WARDROBE
- TO ADD OPTIONAL BOOTSHelf IN WARDROBE, ADD **-BS** TO SKU. UP-CHARGES APPLY SEE [LEV-5](#)

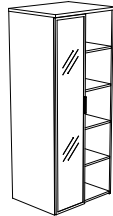
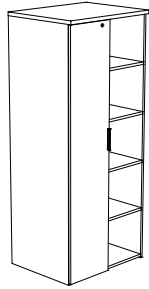

LEV-7230OWL-24  
LEV-7230OWL-24-AGD

**OPEN WARDROBE STORAGE - OPEN SHELVES/WARDROBE RIGHT**

2 FIXED SHELVES & 2 ADJUSTABLE SHELVES

|                |         |       |     |      |       |       |      |
|----------------|---------|-------|-----|------|-------|-------|------|
| LEV-6524OWR-24 | \$1,408 | \$632 | 200 | 26   | 23.75 | 23.75 | 64.5 |
| LEV-6530OWR-24 | \$1,557 | \$671 | 222 | 32.8 | 29.5  | 23.75 | 64.5 |

3 FIXED SHELVES & 2 ADJUSTABLE SHELVES

|                |         |       |     |      |       |       |       |
|----------------|---------|-------|-----|------|-------|-------|-------|
| LEV-7224OWR-24 | \$1,611 | \$700 | 233 | 30   | 23.75 | 23.75 | 71.5  |
| LEV-7230OWR-24 | \$1,754 | \$744 | 225 | 36.3 | 29.5  | 23.75 | 71.5  |
| LEV-7724OWR-24 | \$1,684 | \$729 | 233 | 30   | 23.75 | 23.75 | 76.25 |
| LEV-7730OWR-24 | \$1,866 | \$802 | 241 | 38   | 29.5  | 23.75 | 76.25 |

4 FIXED SHELVES & 2 ADJUSTABLE SHELVES

|                |         |       |     |    |       |       |       |
|----------------|---------|-------|-----|----|-------|-------|-------|
| LEV-8424OWR-24 | \$1,822 | \$829 | 234 | 35 | 23.75 | 23.75 | 83.25 |
| LEV-8430OWR-24 | \$2,002 | \$901 | 262 | 42 | 29.5  | 23.75 | 83.25 |

- INCLUDES COAT ROD & HAT SHELF
- LOCKING WARDROBE
- TO ADD OPTIONAL BOOTSHelf IN WARDROBE, ADD **-BS** TO SKU. UP-CHARGES APPLY SEE [LEV-5](#)

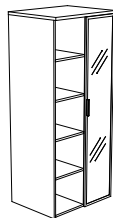
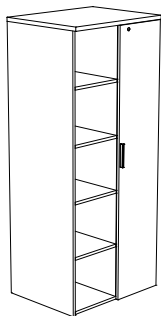

LEV-7230OWR-24  
LEV-7230OWR-24-AGD

**OPEN WARDROBE STORAGE W/ STORAGE RISER - OPEN SHELVES/WARDROBE LEFT**

1 FIXED SHELF & 3 ADJUSTABLE SHELVES

|                   |         |       |     |      |       |       |      |
|-------------------|---------|-------|-----|------|-------|-------|------|
| LEV-6524OWL-24-SR | \$1,336 | \$575 | 200 | 26   | 23.75 | 23.75 | 64.5 |
| LEV-6530OWL-24-SR | \$1,406 | \$604 | 222 | 32.8 | 29.5  | 23.75 | 64.5 |

2 FIXED SHELVES & 2 ADJUSTABLE SHELVES

|                   |         |       |     |      |       |       |       |
|-------------------|---------|-------|-----|------|-------|-------|-------|
| LEV-7224OWL-24-SR | \$1,466 | \$632 | 225 | 30   | 23.75 | 23.75 | 71.5  |
| LEV-7230OWL-24-SR | \$1,615 | \$671 | 233 | 36.3 | 29.5  | 23.75 | 71.5  |
| LEV-7724OWL-24-SR | \$1,669 | \$700 | 233 | 30   | 23.75 | 23.75 | 76.25 |
| LEV-7730OWL-24-SR | \$1,812 | \$744 | 241 | 38   | 29.5  | 23.75 | 76.25 |

2 FIXED SHELVES & 3 ADJUSTABLE SHELVES

|                   |         |       |     |    |       |       |       |
|-------------------|---------|-------|-----|----|-------|-------|-------|
| LEV-8424OWL-24-SR | \$1,742 | \$729 | 234 | 35 | 23.75 | 23.75 | 83.25 |
| LEV-8430OWL-24-SR | \$1,924 | \$802 | 262 | 42 | 29.5  | 23.75 | 83.25 |

- INCLUDES COAT ROD & HAT SHELF
- LOCKING WARDROBE
- TO ADD OPTIONAL BOOTSHelf IN WARDROBE, ADD **-BS** TO SKU. UP-CHARGES APPLY SEE [LEV-5](#)

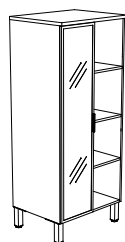
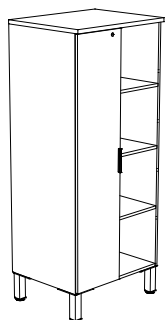

LEV-7230OWL-24-SR  
LEV-7230OWL-24-SR-AGD

**LEVELS SERIES**  
**TALL STORAGE CABINETS**

| MODEL | LIST | *AGD     | WEIGHT | CUBE            | W  | D  | H  |
|-------|------|----------|--------|-----------------|----|----|----|
|       |      | UPCHARGE | LBS    | FT <sup>3</sup> | IN | IN | IN |

**OPEN WARDROBE STORAGE W/ STORAGE RISER - OPEN SHELVES/WARDROBE RIGHT**

1 FIXED SHELF & 3 ADJUSTABLE SHELVES

|                   |         |       |     |      |       |       |      |
|-------------------|---------|-------|-----|------|-------|-------|------|
| LEV-6524OWR-24-SR | \$1,336 | \$575 | 200 | 26   | 23.75 | 23.75 | 64.5 |
| LEV-6530OWR-24-SR | \$1,406 | \$604 | 222 | 32.8 | 29.5  | 23.75 | 64.5 |

2 FIXED SHELVES & 2 ADJUSTABLE SHELVES

|                   |         |       |     |      |       |       |       |
|-------------------|---------|-------|-----|------|-------|-------|-------|
| LEV-7224OWR-24-SR | \$1,466 | \$632 | 233 | 30   | 23.75 | 23.75 | 71.5  |
| LEV-7230OWR-24-SR | \$1,615 | \$671 | 225 | 36.3 | 29.5  | 23.75 | 71.5  |
| LEV-7724OWR-24-SR | \$1,669 | \$700 | 233 | 30   | 23.75 | 23.75 | 76.25 |
| LEV-7730OWR-24-SR | \$1,812 | \$744 | 241 | 38   | 29.5  | 23.75 | 76.25 |

2 FIXED SHELVES & 3 ADJUSTABLE SHELVES

|                   |         |       |     |    |       |       |       |
|-------------------|---------|-------|-----|----|-------|-------|-------|
| LEV-8424OWR-24-SR | \$1,742 | \$729 | 234 | 35 | 23.75 | 23.75 | 83.25 |
| LEV-8430OWR-24-SR | \$1,924 | \$802 | 262 | 42 | 29.5  | 23.75 | 83.25 |

- INCLUDES COAT ROD & HAT SHELF
- LOCKING WARDROBE
- TO ADD OPTIONAL BOOTSHLEF IN WARDROBE, ADD **-BS** TO SKU. UP-CHARGES APPLY SEE [LEV-5](#)

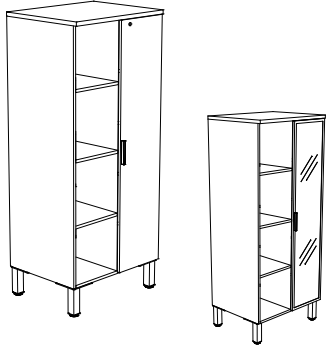

LEV-7230OWR-24-SR  
LEV-7230OWR-24-SR-AGD

**OPEN WARDROBE STORAGE - OPEN SHELVES/FILE/WARDROBE LEFT**

1 FIXED SHELF & 2 ADJUSTABLE SHELVES

|                 |         |       |     |      |       |       |      |
|-----------------|---------|-------|-----|------|-------|-------|------|
| LEV-6524OFWL-24 | \$1,663 | \$646 | 199 | 26   | 23.75 | 23.75 | 64.5 |
| LEV-6530OFWL-24 | \$1,706 | \$671 | 222 | 32.8 | 29.5  | 23.75 | 64.5 |

1 FIXED SHELF & 3 ADJUSTABLE SHELVES

|                 |         |       |     |      |       |       |       |
|-----------------|---------|-------|-----|------|-------|-------|-------|
| LEV-7224OFWL-24 | \$1,948 | \$700 | 228 | 29.3 | 23.75 | 23.75 | 71.5  |
| LEV-7230OFWL-24 | \$2,090 | \$744 | 249 | 36.3 | 29.5  | 23.75 | 71.5  |
| LEV-7724OFWL-24 | \$2,002 | \$729 | 237 | 30   | 23.75 | 23.75 | 76.25 |
| LEV-7730OFWL-24 | \$2,169 | \$802 | 252 | 38   | 29.5  | 23.75 | 76.25 |

1 FIXED SHELF & 3 ADJUSTABLE SHELVES

|                 |         |       |     |    |       |       |       |
|-----------------|---------|-------|-----|----|-------|-------|-------|
| LEV-8424OFWL-24 | \$2,140 | \$829 | 240 | 35 | 23.75 | 23.75 | 83.25 |
| LEV-8430OFWL-24 | \$2,307 | \$901 | 270 | 42 | 29.5  | 23.75 | 83.25 |

- INCLUDES COAT ROD & HAT SHELF
- TO ADD OPTIONAL BOOTSHLEF IN WARDROBE, ADD **-BS** TO SKU. UP-CHARGES APPLY SEE [LEV-5](#)

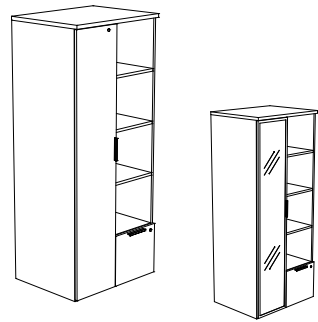

LEV-7230OFWL-24  
LEV-7230OFWL-24-AGD

**OPEN WARDROBE STORAGE - OPEN SHELVES/FILE/WARDROBE RIGHT**

1 FIXED SHELF & 2 ADJUSTABLE SHELVES

|                 |         |       |     |      |       |       |      |
|-----------------|---------|-------|-----|------|-------|-------|------|
| LEV-6524OFWR-24 | \$1,663 | \$646 | 199 | 26   | 23.75 | 23.75 | 64.5 |
| LEV-6530OFWR-24 | \$1,706 | \$671 | 222 | 32.8 | 29.5  | 23.75 | 64.5 |

1 FIXED SHELF & 3 ADJUSTABLE SHELVES

|                 |         |       |     |      |       |       |       |
|-----------------|---------|-------|-----|------|-------|-------|-------|
| LEV-7224OFWR-24 | \$1,948 | \$700 | 228 | 29.3 | 23.75 | 23.75 | 71.5  |
| LEV-7230OFWR-24 | \$2,090 | \$744 | 249 | 36.3 | 29.5  | 23.75 | 71.5  |
| LEV-7724OFWR-24 | \$2,002 | \$729 | 237 | 30   | 23.75 | 23.75 | 76.25 |
| LEV-7730OFWR-24 | \$2,169 | \$802 | 252 | 38   | 29.5  | 23.75 | 76.25 |

1 FIXED SHELF & 4 ADJUSTABLE SHELVES

|                 |         |       |     |    |       |       |       |
|-----------------|---------|-------|-----|----|-------|-------|-------|
| LEV-8424OFWR-24 | \$2,140 | \$829 | 240 | 35 | 23.75 | 23.75 | 83.25 |
| LEV-8430OFWR-24 | \$2,307 | \$901 | 270 | 42 | 29.5  | 23.75 | 83.25 |

- INCLUDES COAT ROD & HAT SHELF
- LOCKING FILE DRAWER & WARDROBE
- TO ADD OPTIONAL BOOTSHLEF IN WARDROBE, ADD **-BS** TO SKU. UP-CHARGES APPLY SEE [LEV-5](#)

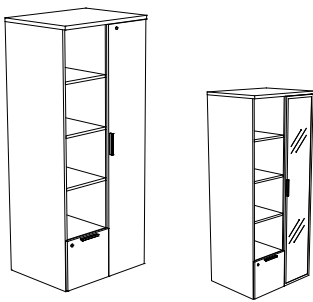

LEV-7230OFWR-24  
LEV-7230OFWR-24-AGD



| MODEL | LIST     | *AGD | WEIGHT | CUBE            | W  | D  | H  |
|-------|----------|------|--------|-----------------|----|----|----|
|       | UPCHARGE |      | LBS    | FT <sup>3</sup> | IN | IN | IN |

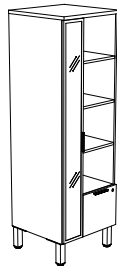
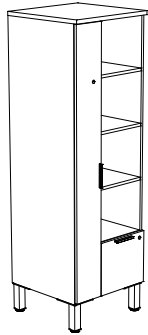

LEV-7724OFWL-24-SR  
LEV-7724OFWL-24-SR-AGD

**OPEN WARDROBE STORAGE W/ STORAGE RISER - OPEN SHELVES/FILE/WARDROBE LEFT**

1 FIXED SHELF & 2 ADJUSTABLE SHELVES

|                    |                |              |     |      |       |       |      |
|--------------------|----------------|--------------|-----|------|-------|-------|------|
| LEV-6524OFWL-24-SR | <b>\$1,671</b> | <i>\$575</i> | 199 | 26   | 23.75 | 23.75 | 64.5 |
| LEV-6530OFWL-24-SR | <b>\$1,721</b> | <i>\$629</i> | 222 | 32.8 | 29.5  | 23.75 | 64.5 |
| LEV-7224OFWL-24-SR | <b>\$1,721</b> | <i>\$646</i> | 228 | 29.3 | 23.75 | 23.75 | 71.5 |
| LEV-7230OFWL-24-SR | <b>\$1,764</b> | <i>\$671</i> | 249 | 36.3 | 29.5  | 23.75 | 71.5 |

1 FIXED SHELF & 3 ADJUSTABLE SHELVES

|                    |                |              |     |    |       |       |       |
|--------------------|----------------|--------------|-----|----|-------|-------|-------|
| LEV-7724OFWL-24-SR | <b>\$2,006</b> | <i>\$700</i> | 237 | 30 | 23.75 | 23.75 | 76.25 |
| LEV-7730OFWL-24-SR | <b>\$2,148</b> | <i>\$744</i> | 252 | 38 | 29.5  | 23.75 | 76.25 |
| LEV-8424OFWL-24-SR | <b>\$2,060</b> | <i>\$729</i> | 240 | 35 | 23.75 | 23.75 | 83.25 |
| LEV-8430OFWL-24-SR | <b>\$2,227</b> | <i>\$802</i> | 270 | 42 | 29.5  | 23.75 | 83.25 |

- INCLUDES COAT ROD & HAT SHELF
- LOCKING FILE DRAWER & WARDROBE
- TO ADD OPTIONAL BOOTSHelf IN WARDROBE, ADD **-BS** TO SKU. UP-CHARGES APPLY SEE [LEV-5](#)

**OPEN WARDROBE STORAGE W/ - OPEN SHELVES/FILE/WARDROBE RIGHT**

1 FIXED SHELF & 2 ADJUSTABLE SHELVES

|                    |                |              |     |      |       |       |      |
|--------------------|----------------|--------------|-----|------|-------|-------|------|
| LEV-6524OFWR-24-SR | <b>\$1,671</b> | <i>\$575</i> | 199 | 26   | 23.75 | 23.75 | 64.5 |
| LEV-6530OFWR-24-SR | <b>\$1,721</b> | <i>\$629</i> | 222 | 32.8 | 29.5  | 23.75 | 64.5 |
| LEV-7224OFWR-24-SR | <b>\$1,721</b> | <i>\$646</i> | 228 | 29.3 | 23.75 | 23.75 | 71.5 |
| LEV-7230OFWR-24-SR | <b>\$1,764</b> | <i>\$671</i> | 249 | 36.3 | 29.5  | 23.75 | 71.5 |

1 FIXED SHELF & 3 ADJUSTABLE SHELVES

|                    |                |              |     |    |       |       |       |
|--------------------|----------------|--------------|-----|----|-------|-------|-------|
| LEV-7724OFWR-24-SR | <b>\$2,006</b> | <i>\$700</i> | 237 | 30 | 23.75 | 23.75 | 76.25 |
| LEV-7730OFWR-24-SR | <b>\$2,148</b> | <i>\$744</i> | 252 | 38 | 29.5  | 23.75 | 76.25 |
| LEV-8424OFWR-24-SR | <b>\$2,060</b> | <i>\$729</i> | 240 | 35 | 23.75 | 23.75 | 83.25 |
| LEV-8430OFWR-24-SR | <b>\$2,227</b> | <i>\$802</i> | 270 | 42 | 29.5  | 23.75 | 83.25 |

- INCLUDES COAT ROD & HAT SHELF
- LOCKING FILE DRAWER & WARDROBE
- TO ADD OPTIONAL BOOTSHelf IN WARDROBE, ADD **-BS** TO SKU. UP-CHARGES APPLY SEE [LEV-5](#)

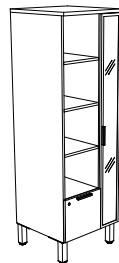
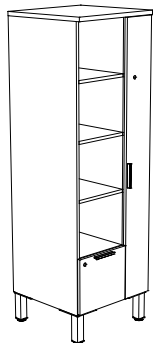

LEV-7724OFWR-24  
LEV-7724OFWR-24-AGD

# LEVELS SERIES TALL STORAGE CABINETS

| MODEL | LIST | *AGD     | WEIGHT | CUBE            | W  | D  | H  |
|-------|------|----------|--------|-----------------|----|----|----|
|       |      | UPCHARGE | LBS    | FT <sup>3</sup> | IN | IN | IN |

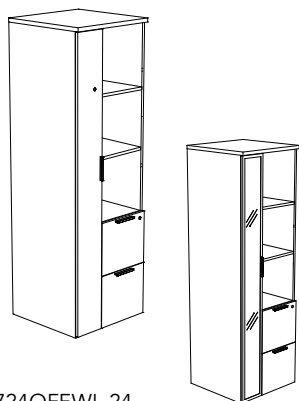

LEV-7724OFFWL-24  
LEV-7724OFFWL-24-AGD

### OPEN WARDROBE STORAGE - OPEN SHELVES/FILE/FILE/ WARDROBE LEFT

1 FIXED SHELF & 1 ADJUSTABLE SHELF

|                  |         |       |     |      |       |       |      |
|------------------|---------|-------|-----|------|-------|-------|------|
| LEV-6524OFFWL-24 | \$1,990 | \$646 | 201 | 26   | 23.75 | 23.75 | 64.5 |
| LEV-6530OFFWL-24 | \$2,000 | \$671 | 232 | 32.8 | 29.5  | 23.75 | 64.5 |

1 FIXED SHELF & 2 ADJUSTABLE SHELVES

|                  |         |       |     |      |       |       |      |
|------------------|---------|-------|-----|------|-------|-------|------|
| LEV-7224OFFWL-24 | \$2,051 | \$700 | 238 | 29.3 | 23.75 | 23.75 | 71.5 |
| LEV-7230OFFWL-24 | \$2,100 | \$744 | 251 | 36.3 | 29.5  | 23.75 | 71.5 |

|                  |         |       |     |    |       |       |       |
|------------------|---------|-------|-----|----|-------|-------|-------|
| LEV-7724OFFWL-24 | \$2,117 | \$729 | 251 | 30 | 23.75 | 23.75 | 76.25 |
|------------------|---------|-------|-----|----|-------|-------|-------|

|                  |         |       |     |    |      |       |       |
|------------------|---------|-------|-----|----|------|-------|-------|
| LEV-7730OFFWL-24 | \$2,171 | \$802 | 277 | 38 | 29.5 | 23.75 | 76.25 |
|------------------|---------|-------|-----|----|------|-------|-------|

1 FIXED SHELF & 3 ADJUSTABLE SHELVES

|                  |         |       |     |    |       |       |       |
|------------------|---------|-------|-----|----|-------|-------|-------|
| LEV-8424OFFWL-24 | \$2,238 | \$829 | 271 | 35 | 23.75 | 23.75 | 83.25 |
|------------------|---------|-------|-----|----|-------|-------|-------|

|                  |         |       |     |    |      |       |       |
|------------------|---------|-------|-----|----|------|-------|-------|
| LEV-8430OFFWL-24 | \$2,255 | \$901 | 297 | 42 | 29.5 | 23.75 | 83.25 |
|------------------|---------|-------|-----|----|------|-------|-------|

- INCLUDES COAT ROD & HAT SHELF
- LOCKING DRAWERS & WARDROBE
- TO ADD OPTIONAL BOOTSHelf IN WARDROBE, ADD **-BS** TO SKU. UP-CHARGES APPLY SEE [LEV-5](#)

### OPEN WARDROBE STORAGE - OPEN SHELVES/FILE/FILE/ WARDROBE RIGHT

1 FIXED SHELF & 1 ADJUSTABLE SHELF

|                  |         |       |     |      |       |       |      |
|------------------|---------|-------|-----|------|-------|-------|------|
| LEV-6524OFFWR-24 | \$1,990 | \$646 | 201 | 26   | 23.75 | 23.75 | 64.5 |
| LEV-6530OFFWR-24 | \$2,000 | \$671 | 232 | 32.8 | 29.5  | 23.75 | 64.5 |

1 FIXED SHELF & 2 ADJUSTABLE SHELVES

|                  |         |       |     |      |       |       |      |
|------------------|---------|-------|-----|------|-------|-------|------|
| LEV-7224OFFWR-24 | \$2,051 | \$700 | 238 | 29.3 | 23.75 | 23.75 | 71.5 |
| LEV-7230OFFWR-24 | \$2,100 | \$744 | 251 | 36.3 | 29.5  | 23.75 | 71.5 |

|                  |         |       |     |    |       |       |       |
|------------------|---------|-------|-----|----|-------|-------|-------|
| LEV-7724OFFWR-24 | \$2,117 | \$729 | 251 | 30 | 23.75 | 23.75 | 76.25 |
|------------------|---------|-------|-----|----|-------|-------|-------|

|                  |         |       |     |    |      |       |       |
|------------------|---------|-------|-----|----|------|-------|-------|
| LEV-7730OFFWR-24 | \$2,171 | \$802 | 277 | 38 | 29.5 | 23.75 | 76.25 |
|------------------|---------|-------|-----|----|------|-------|-------|

1 FIXED SHELF & 3 ADJUSTABLE SHELVES

|                  |         |       |     |    |       |       |       |
|------------------|---------|-------|-----|----|-------|-------|-------|
| LEV-8424OFFWR-24 | \$2,238 | \$829 | 271 | 35 | 23.75 | 23.75 | 83.25 |
|------------------|---------|-------|-----|----|-------|-------|-------|

|                  |         |       |     |    |      |       |       |
|------------------|---------|-------|-----|----|------|-------|-------|
| LEV-8430OFFWR-24 | \$2,255 | \$901 | 297 | 42 | 29.5 | 23.75 | 83.25 |
|------------------|---------|-------|-----|----|------|-------|-------|

- INCLUDES COAT ROD & HAT SHELF
- LOCKING DRAWERS & WARDROBE
- TO ADD OPTIONAL BOOTSHelf IN WARDROBE, ADD **-BS** TO SKU. UP-CHARGES APPLY SEE [LEV-5](#)

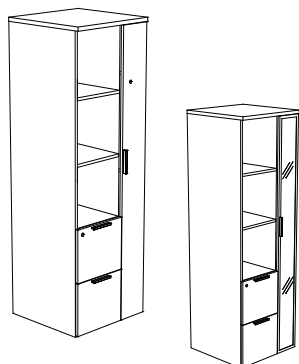

LEV-7724OFFWR-24  
LEV-7724OFFWR-24-AGD

### OPEN WARDROBE STORAGE W/ STORAGE RISER - OPEN SHELVES/BOX/FILE/ WARDROBE LEFT

1 FIXED SHELF & 1 ADJUSTABLE SHELF

|                     |         |       |     |      |       |       |      |
|---------------------|---------|-------|-----|------|-------|-------|------|
| LEV-6524OBFWL-24-SR | \$1,841 | \$575 | 201 | 26   | 23.75 | 23.75 | 64.5 |
| LEV-6530OBFWL-24-SR | \$2,057 | \$629 | 232 | 32.8 | 29.5  | 23.75 | 64.5 |

1 FIXED SHELF & 2 ADJUSTABLE SHELVES

|                     |         |       |     |      |       |       |      |
|---------------------|---------|-------|-----|------|-------|-------|------|
| LEV-7224OBFWL-24-SR | \$1,896 | \$646 | 238 | 29.3 | 23.75 | 23.75 | 71.5 |
|---------------------|---------|-------|-----|------|-------|-------|------|

|                     |         |       |     |      |      |       |      |
|---------------------|---------|-------|-----|------|------|-------|------|
| LEV-7230OBFWL-24-SR | \$2,069 | \$671 | 251 | 36.3 | 29.5 | 23.75 | 71.5 |
|---------------------|---------|-------|-----|------|------|-------|------|

|                     |         |       |     |    |       |       |       |
|---------------------|---------|-------|-----|----|-------|-------|-------|
| LEV-7724OBFWL-24-SR | \$2,011 | \$700 | 251 | 30 | 23.75 | 23.75 | 76.25 |
|---------------------|---------|-------|-----|----|-------|-------|-------|

|                     |         |       |     |    |      |       |       |
|---------------------|---------|-------|-----|----|------|-------|-------|
| LEV-7730OBFWL-24-SR | \$2,188 | \$744 | 277 | 38 | 29.5 | 23.75 | 76.25 |
|---------------------|---------|-------|-----|----|------|-------|-------|

1 FIXED SHELF & 3 ADJUSTABLE SHELVES

|                     |         |       |     |    |       |       |       |
|---------------------|---------|-------|-----|----|-------|-------|-------|
| LEV-8424OBFWL-24-SR | \$2,071 | \$729 | 271 | 35 | 23.75 | 23.75 | 83.25 |
|---------------------|---------|-------|-----|----|-------|-------|-------|

|                     |         |       |     |    |      |       |       |
|---------------------|---------|-------|-----|----|------|-------|-------|
| LEV-8430OBFWL-24-SR | \$2,292 | \$802 | 297 | 42 | 29.5 | 23.75 | 83.25 |
|---------------------|---------|-------|-----|----|------|-------|-------|

- INCLUDES COAT ROD & HAT SHELF
- LOCKING DRAWERS & WARDROBE
- TO ADD OPTIONAL BOOTSHelf IN WARDROBE, ADD **-BS** TO SKU. UP-CHARGES APPLY SEE [LEV-5](#)

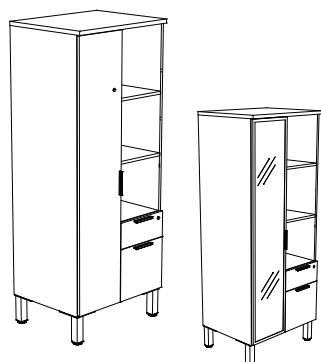

LEV-7730OBFWL-24-SR  
LEV-7730OBFWL-24-SR-AGD

| MODEL | LIST | *AGD      | WEIGHT | CUBE            | W  | D  | H  |
|-------|------|-----------|--------|-----------------|----|----|----|
|       |      | UP CHARGE | LBS    | FT <sup>3</sup> | IN | IN | IN |

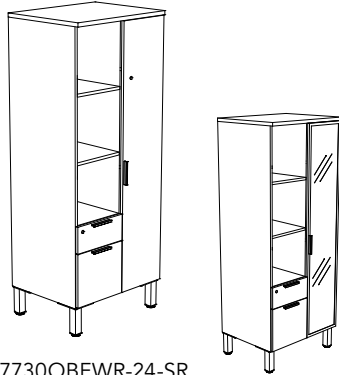

LEV-7730OBFWR-24-SR  
LEV-7730OBFWR-24-SR-AGD

**OPEN WARDROBE STORAGE W/ STORAGE RISER - OPEN SHELVES/BOX/FILE/ WARDROBE RIGHT**

1 FIXED SHELF & 1 ADJUSTABLE SHELF

|                     |                |       |     |      |       |       |      |
|---------------------|----------------|-------|-----|------|-------|-------|------|
| LEV-6524OBFWR-24-SR | <b>\$1,841</b> | \$575 | 201 | 26   | 23.75 | 23.75 | 64.5 |
| LEV-6530OBFWR-24-SR | <b>\$2,057</b> | \$629 | 232 | 32.8 | 29.5  | 23.75 | 64.5 |

1 FIXED SHELF & 2 ADJUSTABLE SHELVES

|                     |                |       |     |      |       |       |       |
|---------------------|----------------|-------|-----|------|-------|-------|-------|
| LEV-7224OBFWR-24-SR | <b>\$1,896</b> | \$657 | 238 | 29.3 | 23.75 | 23.75 | 71.5  |
| LEV-7230OBFWR-24-SR | <b>\$2,069</b> | \$671 | 251 | 36.3 | 29.5  | 23.75 | 71.5  |
| LEV-7724OBFWR-24-SR | <b>\$2,011</b> | \$700 | 251 | 30   | 23.75 | 23.75 | 76.25 |

1 FIXED SHELF & 3 ADJUSTABLE SHELVES

|                     |                |       |     |    |       |       |       |
|---------------------|----------------|-------|-----|----|-------|-------|-------|
| LEV-8424OBFWR-24-SR | <b>\$2,071</b> | \$729 | 271 | 35 | 23.75 | 23.75 | 83.25 |
| LEV-8430OBFWR-24-SR | <b>\$2,292</b> | \$802 | 297 | 42 | 29.5  | 23.75 | 83.25 |

- INCLUDES COAT ROD & HAT SHELF
- LOCKING DRAWERS & WARDROBE
- TO ADD OPTIONAL BOOTSHelf IN WARDROBE, ADD **-BS** TO SKU. UP-CHARGES APPLY SEE [LEV-5](#)

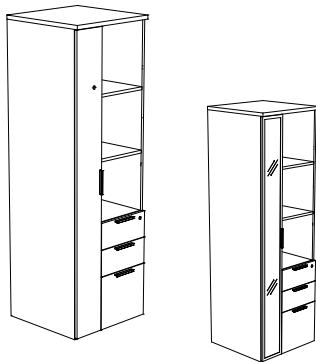

LEV-7724OUFWL-24  
LEV-7724OUFWL-24-AGD

**OPEN WARDROBE STORAGE - OPEN SHELVES/BOX/BOX/FILE/WARDROBE LEFT**

1 FIXED SHELF & 1 ADJUSTABLE SHELF

|                  |                |       |     |      |       |       |      |
|------------------|----------------|-------|-----|------|-------|-------|------|
| LEV-6524OUFWL-24 | <b>\$1,920</b> | \$646 | 208 | 26   | 23.75 | 23.75 | 64.5 |
| LEV-6530OUFWL-24 | <b>\$2,012</b> | \$671 | 229 | 32.3 | 29.5  | 23.75 | 64.5 |

1 FIXED SHELF & 2 ADJUSTABLE SHELVES

|                  |                |       |     |      |       |       |       |
|------------------|----------------|-------|-----|------|-------|-------|-------|
| LEV-7224OUFWL-24 | <b>\$1,953</b> | \$700 | 241 | 29.3 | 23.75 | 23.75 | 71.5  |
| LEV-7230OUFWL-24 | <b>\$2,131</b> | \$744 | 272 | 36.3 | 29.5  | 23.75 | 71.5  |
| LEV-7724OUFWL-24 | <b>\$2,014</b> | \$729 | 251 | 30   | 23.75 | 23.75 | 76.25 |

1 FIXED SHELF & 3 ADJUSTABLE SHELVES

|                  |                |       |     |    |       |       |       |
|------------------|----------------|-------|-----|----|-------|-------|-------|
| LEV-8424OUFWL-24 | <b>\$2,152</b> | \$829 | 271 | 35 | 23.75 | 23.75 | 83.25 |
| LEV-8430OUFWL-24 | <b>\$2,372</b> | \$901 | 297 | 42 | 29.5  | 23.75 | 83.25 |

- INCLUDES COAT ROD & HAT SHELF
- LOCKING DRAWERS & WARDROBE
- TO ADD OPTIONAL BOOTSHelf IN WARDROBE, ADD **-BS** TO SKU. UP-CHARGES APPLY SEE [LEV-5](#)

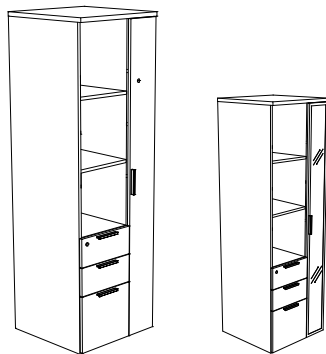

LEV-7724OUFWR-24  
LEV-7724OUFWR-24-AGD

**OPEN WARDROBE STORAGE - OPEN SHELVES/BOX/BOX/FILE/WARDROBE RIGHT**

1 FIXED SHELF & 1 ADJUSTABLE SHELF

|                  |                |       |     |      |       |       |      |
|------------------|----------------|-------|-----|------|-------|-------|------|
| LEV-6524OUFWR-24 | <b>\$1,920</b> | \$646 | 208 | 26   | 23.75 | 23.75 | 64.5 |
| LEV-6530OUFWR-24 | <b>\$2,012</b> | \$671 | 229 | 32.3 | 29.5  | 23.75 | 64.5 |

1 FIXED SHELF & 2 ADJUSTABLE SHELVES

|                  |                |       |     |      |       |       |       |
|------------------|----------------|-------|-----|------|-------|-------|-------|
| LEV-7224OUFWR-24 | <b>\$1,953</b> | \$700 | 241 | 29.3 | 23.75 | 23.75 | 71.5  |
| LEV-7230OUFWR-24 | <b>\$2,131</b> | \$744 | 272 | 36.3 | 29.5  | 23.75 | 71.5  |
| LEV-7724OUFWR-24 | <b>\$2,014</b> | \$729 | 251 | 30   | 23.75 | 23.75 | 76.25 |

1 FIXED SHELF & 3 ADJUSTABLE SHELVES

|                  |                |       |     |    |       |       |       |
|------------------|----------------|-------|-----|----|-------|-------|-------|
| LEV-8424OUFWR-24 | <b>\$2,152</b> | \$829 | 271 | 35 | 23.75 | 23.75 | 83.25 |
| LEV-8430OUFWR-24 | <b>\$2,372</b> | \$901 | 297 | 42 | 29.5  | 23.75 | 83.25 |

- INCLUDES COAT ROD & HAT SHELF
- LOCKING DRAWERS & WARDROBE
- TO ADD OPTIONAL BOOTSHelf IN WARDROBE, ADD **-BS** TO SKU. UP-CHARGES APPLY SEE [LEV-5](#)

**LEVELS SERIES**  
**TALL STORAGE CABINETS**

| MODEL | LIST     | *AGD | WEIGHT | CUBE            | W  | D  | H  |
|-------|----------|------|--------|-----------------|----|----|----|
|       | UPCHARGE |      | LBS    | FT <sup>3</sup> | IN | IN | IN |

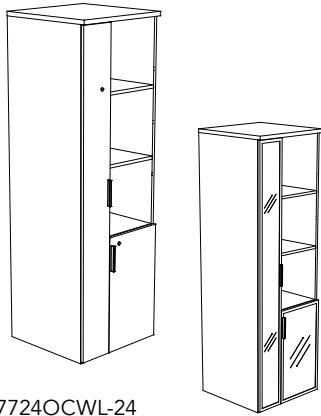

LEV-7724OCWL-24  
LEV-7724OCWL-24-AGD

**OPEN WARDROBE STORAGE - OPEN SHELVES/CABINET/WARDROBE LEFT**

1 FIXED & 2 ADJUSTABLE SHELVES IN UPPER CABINET, 1 FIXED & 1 ADJUSTABLE IN LOWER

|                 |                |       |     |      |       |       |       |
|-----------------|----------------|-------|-----|------|-------|-------|-------|
| LEV-6524OCWL-24 | <b>\$1,590</b> | \$675 | 182 | 26   | 23.75 | 23.75 | 64.5  |
| LEV-6530OCWL-24 | <b>\$1,727</b> | \$724 | 232 | 32.8 | 29.5  | 23.75 | 64.5  |
| LEV-7224OCWL-24 | <b>\$1,762</b> | \$731 | 214 | 29.3 | 23.75 | 23.75 | 71.5  |
| LEV-7230OCWL-24 | <b>\$1,852</b> | \$806 | 235 | 36.3 | 29.5  | 23.75 | 71.5  |
| LEV-7724OCWL-24 | <b>\$1,866</b> | \$782 | 240 | 30   | 23.75 | 23.75 | 76.25 |
| LEV-7730OCWL-24 | <b>\$1,951</b> | \$865 | 254 | 38   | 29.5  | 23.75 | 76.25 |

1 FIXED & 3 ADJUSTABLE SHELVES IN UPPER CABINET, 1 FIXED & 1 ADJUSTABLE IN LOWER

|                 |                |       |     |    |       |       |       |
|-----------------|----------------|-------|-----|----|-------|-------|-------|
| LEV-8424OCWL-24 | <b>\$2,002</b> | \$882 | 244 | 35 | 23.75 | 23.75 | 83.25 |
| LEV-8430OCWL-24 | <b>\$2,089</b> | \$965 | 273 | 42 | 29.5  | 23.75 | 83.25 |

- INCLUDES COAT ROD & HAT SHELF
- LOWER CABINET & WARDROBE LOCK
- TO ADD OPTIONAL BOOTSHelf IN WARDROBE, ADD **-BS** TO SKU. UP-CHARGES APPLY SEE [LEV-5](#)

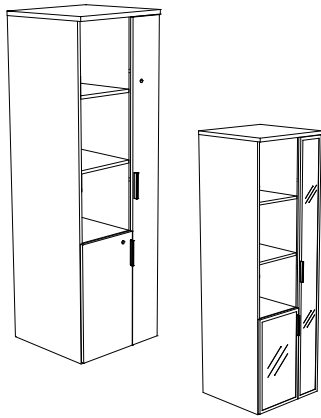

LEV-7724OCWR-24  
LEV-7724OCWR-24-AGD

**OPEN WARDROBE STORAGE - OPEN SHELVES/CABINET/WARDROBE RIGHT**

1 FIXED & 2 ADJUSTABLE SHELVES IN UPPER CABINET, 1 FIXED & 1 ADJUSTABLE IN LOWER

|                 |                |       |     |      |       |       |       |
|-----------------|----------------|-------|-----|------|-------|-------|-------|
| LEV-6524OCWR-24 | <b>\$1,590</b> | \$675 | 182 | 26   | 23.75 | 23.75 | 64.5  |
| LEV-6530OCWR-24 | <b>\$1,727</b> | \$724 | 232 | 32.8 | 29.5  | 23.75 | 64.5  |
| LEV-7224OCWR-24 | <b>\$1,762</b> | \$731 | 214 | 29.3 | 23.75 | 23.75 | 71.5  |
| LEV-7230OCWR-24 | <b>\$1,852</b> | \$806 | 235 | 36.3 | 29.5  | 23.75 | 71.5  |
| LEV-7724OCWR-24 | <b>\$1,866</b> | \$782 | 240 | 30   | 23.75 | 23.75 | 76.25 |
| LEV-7730OCWR-24 | <b>\$1,951</b> | \$865 | 254 | 38   | 29.5  | 23.75 | 76.25 |

1 FIXED & 3 ADJUSTABLE SHELVES IN UPPER CABINET, 1 FIXED & 1 ADJUSTABLE IN LOWER

|                 |                |       |     |    |       |       |       |
|-----------------|----------------|-------|-----|----|-------|-------|-------|
| LEV-8424OCWR-24 | <b>\$2,002</b> | \$882 | 244 | 35 | 23.75 | 23.75 | 83.25 |
| LEV-8430OCWR-24 | <b>\$2,089</b> | \$965 | 273 | 42 | 29.5  | 23.75 | 83.25 |

- INCLUDES COAT ROD & HAT SHELF
- LOWER CABINET & WARDROBE LOCK
- TO ADD OPTIONAL BOOTSHelf IN WARDROBE, ADD **-BS** TO SKU. UP-CHARGES APPLY SEE [LEV-5](#)

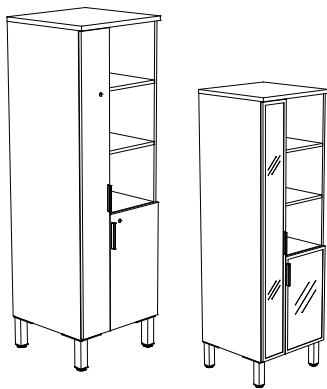

LEV-7724OCWL-24-SR  
LEV-7724OCWL-24-SR-AGD

**OPEN WARDROBE STORAGE W/ STORAGE RISER - OPEN SHELVES/CABINET/WARDROBE LEFT**

1 FIXED & 1 ADJUSTABLE SHELF IN UPPER CABINET, 1 FIXED & 1 ADJUSTABLE IN LOWER

|                    |                |       |     |      |       |       |      |
|--------------------|----------------|-------|-----|------|-------|-------|------|
| LEV-6524OCWL-24-SR | <b>\$1,577</b> | \$646 | 182 | 26   | 23.75 | 23.75 | 64.5 |
| LEV-6530OCWL-24-SR | <b>\$1,709</b> | \$665 | 232 | 32.8 | 29.5  | 23.75 | 64.5 |

1 FIXED & 2 ADJUSTABLE SHELVES IN UPPER CABINET, 1 FIXED & 1 ADJUSTABLE IN LOWER

|                    |                |       |     |      |       |       |       |
|--------------------|----------------|-------|-----|------|-------|-------|-------|
| LEV-7224OCWL-24-SR | <b>\$1,648</b> | \$675 | 214 | 29.3 | 23.75 | 23.75 | 71.5  |
| LEV-7230OCWL-24-SR | <b>\$1,785</b> | \$724 | 235 | 36.3 | 29.5  | 23.75 | 71.5  |
| LEV-7724OCWL-24-SR | <b>\$1,820</b> | \$731 | 240 | 30   | 23.75 | 23.75 | 76.25 |
| LEV-7730OCWL-24-SR | <b>\$1,910</b> | \$806 | 254 | 38   | 29.5  | 23.75 | 76.25 |
| LEV-8424OCWL-24-SR | <b>\$1,924</b> | \$782 | 240 | 30   | 23.75 | 23.75 | 83.25 |
| LEV-8430OCWL-24-SR | <b>\$2,009</b> | \$865 | 272 | 42   | 29.5  | 23.75 | 83.25 |

- INCLUDES COAT ROD & HAT SHELF
- LOWER CABINET & WARDROBE LOCK
- TO ADD OPTIONAL BOOTSHelf IN WARDROBE, ADD **-BS** TO SKU. UP-CHARGES APPLY SEE [LEV-5](#)

| MODEL | LIST | *AGD      | WEIGHT | CUBE            | W  | D  | H  |
|-------|------|-----------|--------|-----------------|----|----|----|
|       |      | UP CHARGE | LBS    | FT <sup>3</sup> | IN | IN | IN |

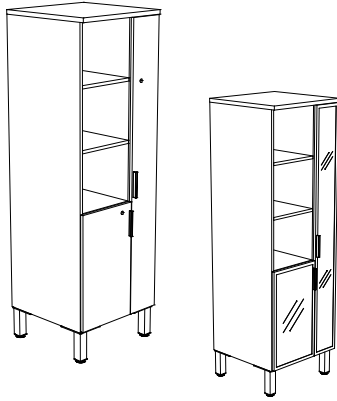

LEV-7724OCWR-24-SR  
LEV-7724OCWR-24-SR-AGD

**OPEN WARDROBE STORAGE W/ STORAGE RISER - OPEN SHELVES/CABINET/WARDROBE RIGHT**

1 FIXED & 1 ADJUSTABLE SHELF IN UPPER CABINET, 1 FIXED & 1 ADJUSTABLE IN LOWER

|                    |                |       |     |      |       |       |      |
|--------------------|----------------|-------|-----|------|-------|-------|------|
| LEV-6524OCWR-24-SR | <b>\$1,577</b> | \$646 | 182 | 26   | 23.75 | 23.75 | 64.5 |
| LEV-6530OCWR-24-SR | <b>\$1,709</b> | \$665 | 232 | 32.8 | 29.5  | 23.75 | 64.5 |

1 FIXED & 2 ADJUSTABLE SHELVES IN UPPER CABINET, 1 FIXED & 1 ADJUSTABLE IN LOWER

|                    |                |       |     |      |       |       |       |
|--------------------|----------------|-------|-----|------|-------|-------|-------|
| LEV-7224OCWR-24-SR | <b>\$1,648</b> | \$675 | 214 | 29.3 | 23.75 | 23.75 | 71.5  |
| LEV-7230OCWR-24-SR | <b>\$1,785</b> | \$724 | 235 | 36.3 | 29.5  | 23.75 | 71.5  |
| LEV-7724OCWR-24-SR | <b>\$1,820</b> | \$731 | 240 | 30   | 23.75 | 23.75 | 76.25 |
| LEV-7730OCWR-24-SR | <b>\$1,910</b> | \$806 | 254 | 38   | 29.5  | 23.75 | 76.25 |
| LEV-8424OCWR-24-SR | <b>\$1,924</b> | \$782 | 244 | 35   | 23.75 | 23.75 | 83.25 |
| LEV-8430OCWR-24-SR | <b>\$2,009</b> | \$865 | 273 | 42   | 29.5  | 23.75 | 83.25 |

- INCLUDES COAT ROD & HAT SHELF
- LOWER CABINET & WARDROBE LOCK
- TO ADD OPTIONAL BOOTSHelf IN WARDROBE, ADD **-BS** TO SKU. UP-CHARGES APPLY SEE [LEV-5](#)

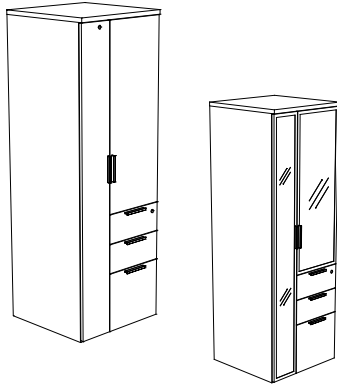

LEV-7224CUFWL-24  
LEV-7224CUFWL-24-AGD

**WARDROBE STORAGE**

CABINET/BOX/BOX/FILE WARDROBE LEFT

1 FIXED SHELF & 1 ADJUSTABLE SHELF

|                  |                |         |     |    |       |       |      |
|------------------|----------------|---------|-----|----|-------|-------|------|
| LEV-6524CUFWL-24 | <b>\$2,281</b> | \$1,031 | 240 | 26 | 23.75 | 23.75 | 64.5 |
|------------------|----------------|---------|-----|----|-------|-------|------|

1 FIXED SHELF & 2 ADJUSTABLE SHELVES

|                  |                |         |     |    |       |       |       |
|------------------|----------------|---------|-----|----|-------|-------|-------|
| LEV-7224CUFWL-24 | <b>\$2,467</b> | \$1,188 | 248 | 27 | 23.75 | 23.75 | 71.5  |
| LEV-7724CUFWL-24 | <b>\$2,635</b> | \$1,213 | 260 | 30 | 23.75 | 23.75 | 76.25 |

1 FIXED SHELF & 3 ADJUSTABLE SHELVES

|                  |                |         |     |    |       |       |       |
|------------------|----------------|---------|-----|----|-------|-------|-------|
| LEV-8424CUFWL-24 | <b>\$2,865</b> | \$1,310 | 281 | 35 | 23.75 | 23.75 | 83.25 |
|------------------|----------------|---------|-----|----|-------|-------|-------|

CABINET/BOX/BOX/FILE WARDROBE RIGHT

1 FIXED SHELF & 1 ADJUSTABLE SHELF

|                  |                |         |     |    |       |       |      |
|------------------|----------------|---------|-----|----|-------|-------|------|
| LEV-6524CUFWR-24 | <b>\$2,281</b> | \$1,031 | 240 | 26 | 23.75 | 23.75 | 64.5 |
|------------------|----------------|---------|-----|----|-------|-------|------|

1 FIXED SHELF & 2 ADJUSTABLE SHELVES

|                  |                |         |     |    |       |       |       |
|------------------|----------------|---------|-----|----|-------|-------|-------|
| LEV-7224CUFWR-24 | <b>\$2,467</b> | \$1,188 | 248 | 27 | 23.75 | 23.75 | 71.5  |
| LEV-7724CUFWR-24 | <b>\$2,635</b> | \$1,213 | 260 | 30 | 23.75 | 23.75 | 76.25 |

1 FIXED SHELF & 3 ADJUSTABLE SHELVES

|                  |                |         |     |    |       |       |       |
|------------------|----------------|---------|-----|----|-------|-------|-------|
| LEV-8424CUFWR-24 | <b>\$2,865</b> | \$1,310 | 281 | 35 | 23.75 | 23.75 | 83.25 |
|------------------|----------------|---------|-----|----|-------|-------|-------|

- INCLUDES COAT ROD & HAT SHELF. BOOT SHELF IS OPTIONAL.
- WARDROBE & DRAWERS ARE LOCKING. OPTIONAL LOCK ON CABINET DOOR [LEV-6](#)
- TO ADD OPTIONAL BOOTSHelf IN WARDROBE, ADD **-BS** TO SKU. UP-CHARGES APPLY SEE [LEV-5](#)

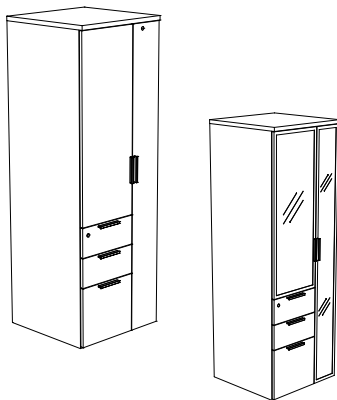

LEV-7224CUFWR-24  
LEV-7224CUFWR-24-AGD

**LEVELS SERIES**  
TALL STORAGE CABINETS

| MODEL | LIST     | *AGD | WEIGHT | CUBE            | W  | D  | H  |
|-------|----------|------|--------|-----------------|----|----|----|
|       | UPCHARGE |      | LBS    | FT <sup>3</sup> | IN | IN | IN |

**WARDROBE STORAGE W/ STORAGE RISER**

CABINET/BOX/FILE WARDROBE LEFT

1 FIXED SHELF & 1 ADJUSTABLE SHELF

|                            |                |              |            |           |              |              |             |
|----------------------------|----------------|--------------|------------|-----------|--------------|--------------|-------------|
| <b>LEV-6524CBFWL-24-SR</b> | <b>\$1,935</b> | <i>\$898</i> | <b>200</b> | <b>26</b> | <b>23.75</b> | <b>23.75</b> | <b>64.5</b> |
|----------------------------|----------------|--------------|------------|-----------|--------------|--------------|-------------|

1 FIXED SHELF & 2 ADJUSTABLE SHELVES

|                            |                |                |            |           |              |              |             |
|----------------------------|----------------|----------------|------------|-----------|--------------|--------------|-------------|
| <b>LEV-7224CBFWL-24-SR</b> | <b>\$2,339</b> | <i>\$1,031</i> | <b>215</b> | <b>27</b> | <b>23.75</b> | <b>23.75</b> | <b>71.5</b> |
|----------------------------|----------------|----------------|------------|-----------|--------------|--------------|-------------|

|                            |                |                |            |           |              |              |              |
|----------------------------|----------------|----------------|------------|-----------|--------------|--------------|--------------|
| <b>LEV-7724CBFWL-24-SR</b> | <b>\$2,467</b> | <i>\$1,188</i> | <b>224</b> | <b>28</b> | <b>23.75</b> | <b>23.75</b> | <b>76.25</b> |
|----------------------------|----------------|----------------|------------|-----------|--------------|--------------|--------------|

1 FIXED SHELF & 3 ADJUSTABLE SHELVES

|                            |                |                |            |           |              |              |              |
|----------------------------|----------------|----------------|------------|-----------|--------------|--------------|--------------|
| <b>LEV-8424CBFWL-24-SR</b> | <b>\$2,693</b> | <i>\$1,213</i> | <b>238</b> | <b>32</b> | <b>23.75</b> | <b>23.75</b> | <b>83.25</b> |
|----------------------------|----------------|----------------|------------|-----------|--------------|--------------|--------------|

- INCLUDES COAT ROD & HAT SHELF
- WARDROBE & DRAWERS ARE LOCKING. OPTIONAL LOCK ON CABINET DOOR SEE [LEV-6](#)
- TO ADD OPTIONAL BOOTSHelf IN WARDROBE, ADD **-BS** TO SKU. UP-CHARGES APPLY SEE [LEV-5](#)

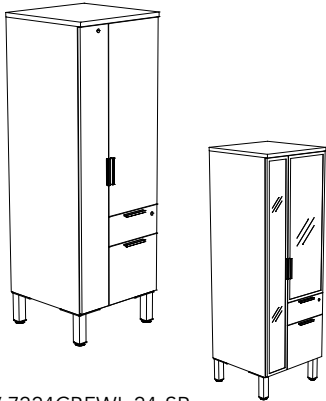

LEV-7224CBFWL-24-SR  
LEV-7224CBFWL-24-SR-AGD

**WARDROBE STORAGE W/ STORAGE RISER**

CABINET/BOX/FILE WARDROBE RIGHT

1 FIXED SHELF & 1 ADJUSTABLE SHELF

|                            |                |              |            |           |              |              |             |
|----------------------------|----------------|--------------|------------|-----------|--------------|--------------|-------------|
| <b>LEV-6524CBFWR-24-SR</b> | <b>\$1,935</b> | <i>\$898</i> | <b>200</b> | <b>26</b> | <b>23.75</b> | <b>23.75</b> | <b>64.5</b> |
|----------------------------|----------------|--------------|------------|-----------|--------------|--------------|-------------|

1 FIXED SHELF & 2 ADJUSTABLE SHELVES

|                            |                |                |            |           |              |              |             |
|----------------------------|----------------|----------------|------------|-----------|--------------|--------------|-------------|
| <b>LEV-7224CBFWR-24-SR</b> | <b>\$2,339</b> | <i>\$1,031</i> | <b>215</b> | <b>27</b> | <b>23.75</b> | <b>23.75</b> | <b>71.5</b> |
|----------------------------|----------------|----------------|------------|-----------|--------------|--------------|-------------|

|                            |                |                |            |           |              |              |              |
|----------------------------|----------------|----------------|------------|-----------|--------------|--------------|--------------|
| <b>LEV-7724CBFWR-24-SR</b> | <b>\$2,467</b> | <i>\$1,188</i> | <b>224</b> | <b>28</b> | <b>23.75</b> | <b>23.75</b> | <b>76.25</b> |
|----------------------------|----------------|----------------|------------|-----------|--------------|--------------|--------------|

1 FIXED SHELF & 3 ADJUSTABLE SHELVES

|                            |                |                |            |           |              |              |              |
|----------------------------|----------------|----------------|------------|-----------|--------------|--------------|--------------|
| <b>LEV-8424CBFWR-24-SR</b> | <b>\$2,693</b> | <i>\$1,213</i> | <b>238</b> | <b>32</b> | <b>23.75</b> | <b>23.75</b> | <b>83.25</b> |
|----------------------------|----------------|----------------|------------|-----------|--------------|--------------|--------------|

- INCLUDES COAT ROD & HAT SHELF
- WARDROBE & DRAWERS ARE LOCKING. OPTIONAL LOCK ON CABINET DOOR SEE [LEV-6](#)
- TO ADD OPTIONAL BOOTSHelf IN WARDROBE, ADD **-BS** TO SKU. UP-CHARGES APPLY SEE [LEV-5](#)

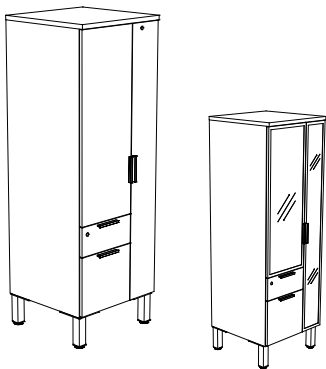

LEV-7224CBFWL-24-SR  
LEV-7224CBFWL-24-SR-AGD

**NOTE:** 20" DEPTH AVAILABLE. REPLACE -24 W/ -20 WHEN ORDERING & USE -24 PRICE. COAT ROAD REPLACED WITH COAT HOOKS IN 20" UNITS

| MODEL | LIST | WEIGHT | CUBE            | W  | D  | H  |
|-------|------|--------|-----------------|----|----|----|
|       |      | LBS    | FT <sup>3</sup> | IN | IN | IN |

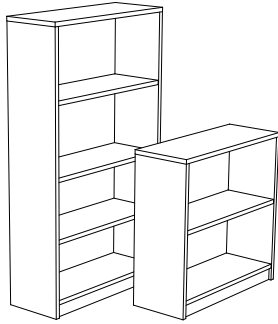

LEV-6536BK & LEV-3636BK

**BOOKCASE**

1 FIXED SHELF & 1 ADJUSTABLE SHELF

|                   |              |             |             |             |              |             |
|-------------------|--------------|-------------|-------------|-------------|--------------|-------------|
| <b>LEV-3636BK</b> | <b>\$675</b> | <b>81.9</b> | <b>11.6</b> | <b>35.5</b> | <b>13.75</b> | <b>35.5</b> |
|-------------------|--------------|-------------|-------------|-------------|--------------|-------------|

1 FIXED SHELF & 2 ADJUSTABLE SHELVES

|                   |              |              |             |             |              |              |
|-------------------|--------------|--------------|-------------|-------------|--------------|--------------|
| <b>LEV-4836BK</b> | <b>\$815</b> | <b>108.6</b> | <b>15.5</b> | <b>35.5</b> | <b>13.75</b> | <b>47.25</b> |
|-------------------|--------------|--------------|-------------|-------------|--------------|--------------|

1 FIXED SHELF & 3 ADJUSTABLE SHELVES

|                   |              |              |             |             |              |             |
|-------------------|--------------|--------------|-------------|-------------|--------------|-------------|
| <b>LEV-5836BK</b> | <b>\$855</b> | <b>132.6</b> | <b>18.6</b> | <b>35.5</b> | <b>13.75</b> | <b>57.5</b> |
|-------------------|--------------|--------------|-------------|-------------|--------------|-------------|

2 FIXED SHELVES & 2 ADJUSTABLE SHELVES

|                   |              |              |             |             |              |             |
|-------------------|--------------|--------------|-------------|-------------|--------------|-------------|
| <b>LEV-6536BK</b> | <b>\$868</b> | <b>141.7</b> | <b>20.9</b> | <b>35.5</b> | <b>13.75</b> | <b>64.5</b> |
|-------------------|--------------|--------------|-------------|-------------|--------------|-------------|

2 FIXED SHELVES & 3 ADJUSTABLE SHELVES

|                   |              |              |             |             |              |             |
|-------------------|--------------|--------------|-------------|-------------|--------------|-------------|
| <b>LEV-7236BK</b> | <b>\$988</b> | <b>161.8</b> | <b>23.1</b> | <b>35.5</b> | <b>13.75</b> | <b>71.5</b> |
|-------------------|--------------|--------------|-------------|-------------|--------------|-------------|

**BOOKCASE W/ STORAGE RISERS**

1 FIXED SHELF, 1 ADJUSTABLE SHELF & STORAGE RISERS

|                      |              |              |             |             |              |             |
|----------------------|--------------|--------------|-------------|-------------|--------------|-------------|
| <b>LEV-4336BK-SR</b> | <b>\$733</b> | <b>104.3</b> | <b>13.9</b> | <b>35.5</b> | <b>13.75</b> | <b>42.5</b> |
|----------------------|--------------|--------------|-------------|-------------|--------------|-------------|

1 FIXED SHELF, 2 ADJUSTABLE SHELVES & STORAGE RISERS

|                      |              |              |             |             |              |              |
|----------------------|--------------|--------------|-------------|-------------|--------------|--------------|
| <b>LEV-5536BK-SR</b> | <b>\$873</b> | <b>130.9</b> | <b>17.7</b> | <b>35.5</b> | <b>13.75</b> | <b>54.25</b> |
|----------------------|--------------|--------------|-------------|-------------|--------------|--------------|

1 FIXED SHELF, 3 ADJUSTABLE SHELVES & STORAGE RISERS

|                      |              |            |             |             |              |             |
|----------------------|--------------|------------|-------------|-------------|--------------|-------------|
| <b>LEV-6536BK-SR</b> | <b>\$913</b> | <b>144</b> | <b>20.9</b> | <b>35.5</b> | <b>13.75</b> | <b>64.5</b> |
|----------------------|--------------|------------|-------------|-------------|--------------|-------------|

2 FIXED SHELVES, 2 ADJUSTABLE SHELVES & STORAGE RISERS

|                      |              |              |             |             |              |             |
|----------------------|--------------|--------------|-------------|-------------|--------------|-------------|
| <b>LEV-7236BK-SR</b> | <b>\$926</b> | <b>164.1</b> | <b>23.1</b> | <b>35.5</b> | <b>13.75</b> | <b>71.5</b> |
|----------------------|--------------|--------------|-------------|-------------|--------------|-------------|

2 FIXED SHELVES, 3 ADJUSTABLE SHELVES & STORAGE RISERS

|                      |                |              |             |             |              |              |
|----------------------|----------------|--------------|-------------|-------------|--------------|--------------|
| <b>LEV-7736BK-SR</b> | <b>\$1,046</b> | <b>181.6</b> | <b>24.7</b> | <b>35.5</b> | <b>13.75</b> | <b>76.25</b> |
|----------------------|----------------|--------------|-------------|-------------|--------------|--------------|

2 FIXED SHELVES, 3 ADJUSTABLE SHELVES & STORAGE RISERS

|                      |                |              |             |             |              |              |
|----------------------|----------------|--------------|-------------|-------------|--------------|--------------|
| <b>LEV-8436BK-SR</b> | <b>\$1,204</b> | <b>190.7</b> | <b>26.9</b> | <b>35.5</b> | <b>13.75</b> | <b>83.25</b> |
|----------------------|----------------|--------------|-------------|-------------|--------------|--------------|

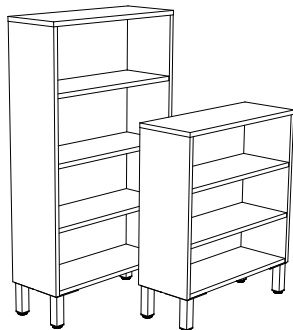

LEV-6536BK-SR & LEV-5536BK-SR

**LEVELS SERIES**  
**STACKING BOOKCASE**

| MODEL | LIST | WEIGHT | CUBE            | W  | D  | H  |
|-------|------|--------|-----------------|----|----|----|
|       |      | LBS    | FT <sup>3</sup> | IN | IN | IN |

**STACKING BOOKCASE**

MATCHES 48" CABINET HEIGHT WHEN PLACED ON 28" NO TOP UNITS

|                |       |      |      |       |    |       |
|----------------|-------|------|------|-------|----|-------|
| LEV-2016SBK-20 | \$605 | 37   | 4.07 | 15.75 | 19 | 19.75 |
| LEV-2024SBK-20 | \$640 | 49.8 | 5.95 | 23.75 | 19 | 19.75 |
| LEV-2030SBK-20 | \$700 | 59.5 | 7.35 | 29.5  | 19 | 19.75 |
| LEV-2036SBK-20 | \$776 | 69.1 | 8.76 | 35.5  | 19 | 19.75 |

- 1 ADJUSTABLE SHELF

MATCHES 55" CABINET HEIGHT WHEN PLACED ON 28" NO TOP UNITS

|                |       |      |       |       |    |       |
|----------------|-------|------|-------|-------|----|-------|
| LEV-2716SBK-20 | \$658 | 43.6 | 5.45  | 15.75 | 19 | 26.75 |
| LEV-2724SBK-20 | \$693 | 57.5 | 7.97  | 23.75 | 19 | 26.75 |
| LEV-2730SBK-20 | \$753 | 67.8 | 9.85  | 29.5  | 19 | 26.75 |
| LEV-2736SBK-20 | \$829 | 78.2 | 11.74 | 35.5  | 19 | 26.75 |

- 1 ADJUSTABLE SHELF

MATCHES 36" HUTCH OR 58" & 65" CABINET HEIGHTS WHEN PLACED ON 21" OR 28" NO TOP UNITS

|                |       |       |       |       |    |      |
|----------------|-------|-------|-------|-------|----|------|
| LEV-3716SBK-20 | \$730 | 57.8  | 7.43  | 15.75 | 19 | 36.5 |
| LEV-3724SBK-20 | \$800 | 75.7  | 10.85 | 23.75 | 19 | 36.5 |
| LEV-3730SBK-20 | \$921 | 89.2  | 13.42 | 29.5  | 19 | 36.5 |
| LEV-3736SBK-20 | \$983 | 102.6 | 15.99 | 35.5  | 19 | 36.5 |

- 2 ADJUSTABLE SHELVES

MATCHES 43" HUTCH OR 65" & 72" CABINET HEIGHTS WHEN PLACED ON 21" OR 28" NO TOP UNITS

|                |         |       |       |       |    |      |
|----------------|---------|-------|-------|-------|----|------|
| LEV-4416SBK-20 | \$806   | 64.5  | 8.81  | 15.75 | 19 | 43.5 |
| LEV-4424SBK-20 | \$863   | 83.4  | 12.87 | 23.75 | 19 | 43.5 |
| LEV-4430SBK-20 | \$981   | 97.6  | 15.92 | 29.5  | 19 | 43.5 |
| LEV-4436SBK-20 | \$1,012 | 111.7 | 18.97 | 35.5  | 19 | 43.5 |

- 2 ADJUSTABLE SHELVES

MATCHES DOUBLE HIGH 48" HUTCH OR 77" HIGH CABINET HEIGHTS WHEN PLACED ON 28" NO TOP UNITS

|                |         |       |       |       |    |       |
|----------------|---------|-------|-------|-------|----|-------|
| LEV-4924SBK-20 | \$899   | 96.2  | 14.31 | 23.75 | 19 | 48.25 |
| LEV-4930SBK-20 | \$1,005 | 112.9 | 17.7  | 29.5  | 19 | 48.25 |
| LEV-4936SBK-20 | \$1,039 | 129.6 | 21.09 | 35.5  | 19 | 48.25 |

- 3 ADJUSTABLE SHELVES

MATCHES DOUBLE HIGH 55" HUTCH OR 84" CABINET HEIGHTS WHEN PLACED ON 28" NO TOP UNITS

|                |         |       |       |       |    |       |
|----------------|---------|-------|-------|-------|----|-------|
| LEV-5624SBK-20 | \$922   | 103.8 | 16.33 | 23.75 | 19 | 55.25 |
| LEV-5630SBK-20 | \$1,022 | 121.3 | 20.2  | 29.5  | 19 | 55.25 |
| LEV-5636SBK-20 | \$1,076 | 138.7 | 24.07 | 35.5  | 19 | 55.25 |

- 3 ADJUSTABLE SHELVES



LEV-2030SBK-20

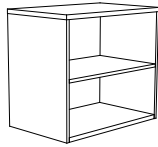

LEV-2730SBK-20



LEV-3730SBK-20

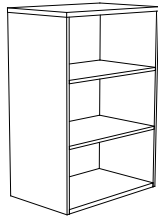

LEV-4430SBK-20

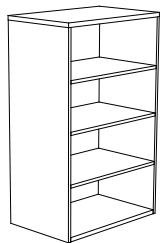

LEV-4930SBK-20

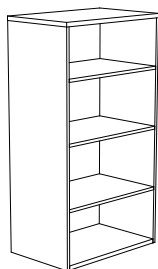

LEV-5630SBK-20

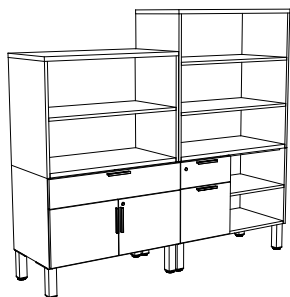



| MODEL | LIST     | *AGD | WEIGHT | CUBE            | W  | D  | H  |
|-------|----------|------|--------|-----------------|----|----|----|
|       | UPCHARGE |      | LBS    | FT <sup>3</sup> | IN | IN | IN |

**OPTIONAL AGD (ALUMINIUM GLAZED DOORS) DOORS**

- AGD DOORS INCLUDE SILVER FINISH BAR HANDLES
- THE PRICE SHOWN FOR AGD DOORS IS AN UPCHARGE THAT MUST BE ADDED TO THE BASE PRICE OF THE UNIT IT GOES ON

AGD FINISHES: CLEAR (CL), FROSTED (FR) OR BRONZE (BR)

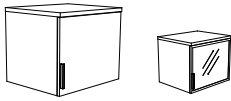

LEV-2024STC-R-20  
LEV-2024STC-R-20-AGD

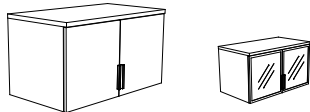

LEV-2036STC-20  
LEV-2036STC-20-AGD

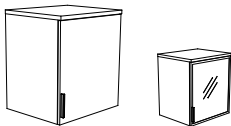

LEV-2724STC-R-20  
LEV-2724STC-R-20-AGD

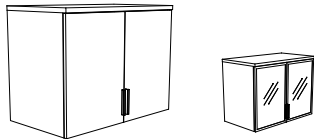

LEV-2736STC-20  
LEV-2736STC-20-AGD

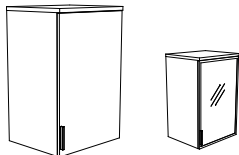

LEV-3724STC-R-20  
LEV-3724STC-R-20-AGD

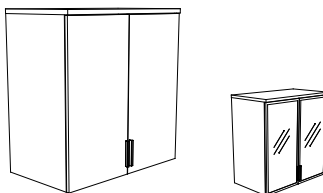

LEV-3736STC-20  
LEV-3736STC-20-AGD

**STACKING CABINETS**

MATCHES 48" CABINET HEIGHT WHEN PLACED ON 28" NO TOP UNITS

SINGLE DOOR HINGED LEFT

|                  |       |       |      |      |       |       |       |
|------------------|-------|-------|------|------|-------|-------|-------|
| LEV-2024STC-L-20 | \$765 | \$331 | 58.6 | 6.24 | 23.75 | 19.75 | 19.75 |
|------------------|-------|-------|------|------|-------|-------|-------|

SINGLE DOOR HINGED RIGHT

|                  |       |       |      |      |       |       |       |
|------------------|-------|-------|------|------|-------|-------|-------|
| LEV-2024STC-R-20 | \$765 | \$331 | 58.6 | 6.24 | 23.75 | 19.75 | 19.75 |
|------------------|-------|-------|------|------|-------|-------|-------|

DOUBLE DOOR

|                |       |       |      |     |      |       |       |
|----------------|-------|-------|------|-----|------|-------|-------|
| LEV-2030STC-20 | \$826 | \$552 | 70.4 | 7.7 | 29.5 | 19.75 | 19.75 |
|----------------|-------|-------|------|-----|------|-------|-------|

|                |       |       |      |     |      |       |       |
|----------------|-------|-------|------|-----|------|-------|-------|
| LEV-2036STC-20 | \$900 | \$613 | 82.2 | 9.2 | 35.5 | 19.75 | 19.75 |
|----------------|-------|-------|------|-----|------|-------|-------|

- 1 ADJUSTABLE SHELF

MATCHES 55" CABINET HEIGHT WHEN PLACED ON 28" NO TOP UNITS

SINGLE DOOR HINGED LEFT

|                  |       |       |      |      |       |       |       |
|------------------|-------|-------|------|------|-------|-------|-------|
| LEV-2724STC-L-20 | \$813 | \$371 | 69.2 | 8.36 | 23.75 | 19.75 | 26.75 |
|------------------|-------|-------|------|------|-------|-------|-------|

SINGLE DOOR HINGED RIGHT

|                  |       |       |      |      |       |       |       |
|------------------|-------|-------|------|------|-------|-------|-------|
| LEV-2724STC-R-20 | \$813 | \$371 | 69.2 | 8.36 | 23.75 | 19.75 | 26.75 |
|------------------|-------|-------|------|------|-------|-------|-------|

DOUBLE DOOR

|                |       |       |      |      |      |       |       |
|----------------|-------|-------|------|------|------|-------|-------|
| LEV-2730STC-20 | \$872 | \$581 | 82.5 | 10.3 | 29.5 | 19.75 | 26.75 |
|----------------|-------|-------|------|------|------|-------|-------|

|                |       |       |      |       |      |       |       |
|----------------|-------|-------|------|-------|------|-------|-------|
| LEV-2736STC-20 | \$949 | \$618 | 95.9 | 12.33 | 35.5 | 19.75 | 26.75 |
|----------------|-------|-------|------|-------|------|-------|-------|

- 1 ADJUSTABLE SHELF

MATCHES 36" HUTCH OR 58" & 65" CABINET HEIGHTS WHEN PLACED ON 21" OR 28" NO TOP UNITS. 2 ADJUSTABLE SHELVES. SINGLE DOOR

SINGLE DOOR HINGED LEFT

|                  |       |       |      |       |       |       |      |
|------------------|-------|-------|------|-------|-------|-------|------|
| LEV-3724STC-L-20 | \$924 | \$456 | 91.8 | 11.39 | 23.75 | 19.75 | 36.5 |
|------------------|-------|-------|------|-------|-------|-------|------|

SINGLE DOOR HINGED RIGHT

|                  |       |       |      |       |       |       |      |
|------------------|-------|-------|------|-------|-------|-------|------|
| LEV-3724STC-R-20 | \$924 | \$456 | 91.8 | 11.39 | 23.75 | 19.75 | 36.5 |
|------------------|-------|-------|------|-------|-------|-------|------|

DOUBLE DOOR

|                |         |       |       |      |      |       |      |
|----------------|---------|-------|-------|------|------|-------|------|
| LEV-3730STC-20 | \$1,011 | \$589 | 109.2 | 14.1 | 29.5 | 19.75 | 36.5 |
|----------------|---------|-------|-------|------|------|-------|------|

|                |         |       |       |      |      |       |      |
|----------------|---------|-------|-------|------|------|-------|------|
| LEV-3736STC-20 | \$1,072 | \$622 | 126.7 | 16.8 | 35.5 | 19.75 | 36.5 |
|----------------|---------|-------|-------|------|------|-------|------|

- 2 ADJUSTABLE SHELVES

# LEVELS SERIES STACKING CABINET

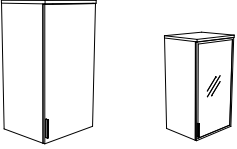
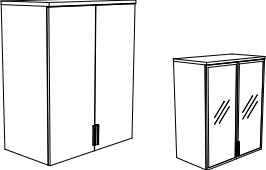
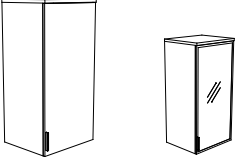
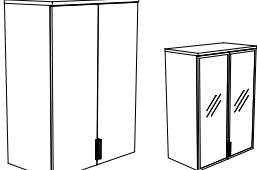
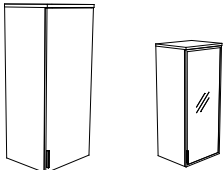
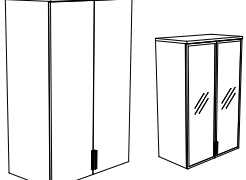
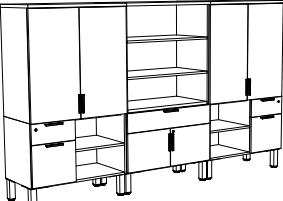
|   | MODEL  | LIST           | *AGD  | WEIGHT       | CUBE            | W            | D            | H            |  |
|---|--|----------------|---|--------------|-----------------|--------------|--------------|--------------|--|
|   |  |                | UPCHARGE  | LBS          | FT <sup>3</sup> | IN           | IN           | IN           |  |
|  <p>LEV-4424STC-R-20<br/>LEV-4424STC-R-20-AGD</p>   | MATCHES 43" HUTCH OR 65" & 72" CABINET HEIGHTS WHEN PLACED ON 21" OR 28" NO TOP UNITS. 2 ADJUSTABLE SHELVES.     |                |   |              |                 |              |              |              |  |
|   | SINGLE DOOR HINGED LEFT  |                |   |              |                 |              |              |              |  |
|   | <b>LEV-4424STC-L-20</b>  | <b>\$1,205</b> | <i>\$477</i>  | <b>102.4</b> | <b>13.51</b>    | <b>23.75</b> | <b>19.75</b> | <b>43.5</b>  |  |
|   | SINGLE DOOR HINGED RIGHT   |                |   |              |                 |              |              |              |  |
|   | <b>LEV-4424STC-R-20</b>  | <b>\$1,205</b> | <i>\$477</i>  | <b>102.4</b> | <b>13.51</b>    | <b>23.75</b> | <b>19.75</b> | <b>43.5</b>  |  |
|  <p>LEV-4436STC-20<br/>LEV-4436STC-20-AGD</p>       | DOUBLE DOOR  |                |   |              |                 |              |              |              |  |
|   | <b>LEV-4430STC-20</b>  | <b>\$1,262</b> | <i>\$629</i>  | <b>121.3</b> | <b>16.7</b>     | <b>29.5</b>  | <b>19.75</b> | <b>43.5</b>  |  |
|   | <b>LEV-4436STC-20</b>  | <b>\$1,301</b> | <i>\$682</i>  | <b>140.3</b> | <b>19.92</b>    | <b>35.5</b>  | <b>19.75</b> | <b>43.5</b>  |  |
|   | • 2 ADJUSTABLE SHELVES   |                |   |              |                 |              |              |              |  |
|  <p>LEV-4924STC-R-20<br/>LEV-4924STC-R-20-AGD</p>   | MATCHES DOUBLE HIGH 48" HUTCH OR 77" HIGH CABINET HEIGHTS WHEN STACKED ON 28" NO TOP UNIT. 3 ADJUSTABLE SHELVES. |                |   |              |                 |              |              |              |  |
|   | SINGLE DOOR HINGED LEFT  |                |   |              |                 |              |              |              |  |
|   | <b>LEV-4924STC-L-20</b>  | <b>\$1,282</b> | <i>\$552</i>  | <b>117.4</b> | <b>15.03</b>    | <b>23.75</b> | <b>19.75</b> | <b>48.25</b> |  |
|   | SINGLE DOOR HINGED RIGHT   |                |   |              |                 |              |              |              |  |
|   | <b>LEV-4924STC-R-20</b>  | <b>\$1,282</b> | <i>\$552</i>  | <b>117.4</b> | <b>15.03</b>    | <b>23.75</b> | <b>19.75</b> | <b>48.25</b> |  |
|  <p>LEV-4936STC-20<br/>LEV-4936STC-20-AGD</p>      | DOUBLE DOOR  |                |   |              |                 |              |              |              |  |
|   | <b>LEV-4930STC-20</b>  | <b>\$1,362</b> | <i>\$706</i>  | <b>144.1</b> | <b>18.6</b>     | <b>29.5</b>  | <b>19.75</b> | <b>48.25</b> |  |
|   | <b>LEV-4936STC-20</b>  | <b>\$1,401</b> | <i>\$742</i>  | <b>161.3</b> | <b>22.16</b>    | <b>35.5</b>  | <b>19.75</b> | <b>48.25</b> |  |
|   | • 3 ADJUSTABLE SHELVES   |                |   |              |                 |              |              |              |  |
|  <p>LEV-5624STC-R-20<br/>LEV-5624STC-R-20-AGD</p> | MATCHES DOUBLE HIGH 55" HUTCH OR 77" HIGH CABINET HEIGHTS WHEN STACKED ON 28" NO TOP UNIT. 3 ADJUSTABLE SHELVES. |                |   |              |                 |              |              |              |  |
|   | SINGLE DOOR HINGED LEFT  |                |   |              |                 |              |              |              |  |
|   | <b>LEV-5624STC-L-20</b>  | <b>\$1,315</b> | <i>\$601</i>  | <b>128.1</b> | <b>17.15</b>    | <b>23.75</b> | <b>19.75</b> | <b>55.25</b> |  |
|   | SINGLE DOOR HINGED RIGHT   |                |   |              |                 |              |              |              |  |
|   | <b>LEV-5624STC-R-20</b>  | <b>\$1,315</b> | <i>\$601</i>  | <b>128.1</b> | <b>17.15</b>    | <b>23.75</b> | <b>19.75</b> | <b>55.25</b> |  |
|  <p>LEV-5636STC-20<br/>LEV-5636STC-20-AGD</p>     | DOUBLE DOOR  |                |   |              |                 |              |              |              |  |
|   | <b>LEV-5630STC-20</b>  | <b>\$1,377</b> | <i>\$826</i>  | <b>156.9</b> | <b>21.2</b>     | <b>29.5</b>  | <b>19.75</b> | <b>55.25</b> |  |
|   | <b>LEV-5636STC-20</b>  | <b>\$1,418</b> | <i>\$861</i>  | <b>175</b>   | <b>25.28</b>    | <b>35.5</b>  | <b>19.75</b> | <b>55.25</b> |  |
|   | • 3 ADJUSTABLE SHELVES   |                |   |              |                 |              |              |              |  |
|   | <b>EXAMPLE 1</b>   |                |   |              |                 |              |              |              |  |
|   | <b>LEV-F2036COX-SR28</b>   | X1             | BOX/FILE OPEN CABINET W/ STORAGE RISERS - NO TOP      |              |                 |              |              |              |  |
|   | <b>LEV-CO2036FX-SR28</b>   | X1             | OPEN CABINET BOX/FILE W/ STORAGE RISERS - NO TOP      |              |                 |              |              |              |  |
|   | <b>LEV-2036WDCX-SR28</b>   | X1             | DRAWERS OVER DOORS CABINET - NO TOP W/ STORAGE RISERS |              |                 |              |              |              |  |
|   | <b>LEV-3736SBK-20</b>  | X1             | STACKING BOOKCASE                                     |              |                 |              |              |              |  |
|   | <b>LEV-3736STC-20</b>  | X2             | STACKING CABINET                                      |              |                 |              |              |              |  |

| MODEL | LIST | WEIGHT | CUBE            | W  | D  | H  |
|-------|------|--------|-----------------|----|----|----|
|       |      | LBS    | FT <sup>3</sup> | IN | IN | IN |

**OPEN HUTCH 36" HIGH**

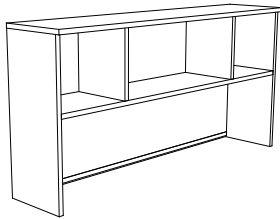

LEV-3672H

|               |         |     |     |       |       |      |
|---------------|---------|-----|-----|-------|-------|------|
| LEV-3630H     | \$553   | 69  | 3   | 29.5  | 15.75 | 35.5 |
| LEV-3636H     | \$601   | 71  | 3   | 35.5  | 15.75 | 35.5 |
| LEV-3642H     | \$649   | 79  | 3.5 | 41.5  | 15.75 | 35.5 |
| LEV-3648H     | \$717   | 87  | 3.5 | 47.25 | 15.75 | 35.5 |
| W/ 2 DIVIDERS |         |     |     |       |       |      |
| LEV-3654H     | \$779   | 96  | 4   | 53.25 | 15.75 | 35.5 |
| LEV-3660H     | \$792   | 105 | 4   | 59.25 | 15.75 | 35.5 |
| LEV-3666H     | \$840   | 120 | 4.5 | 65    | 15.75 | 35.5 |
| LEV-3672H     | \$990   | 135 | 5   | 71    | 15.75 | 35.5 |
| LEV-3678H     | \$1,077 | 150 | 5.5 | 77    | 15.75 | 35.5 |
| LEV-3684H     | \$1,332 | 165 | 6   | 82.75 | 15.75 | 35.5 |

- 36" HUTCHES ALIGN WITH 65" TALL STORAGE

**OPEN HUTCH 43" HIGH**

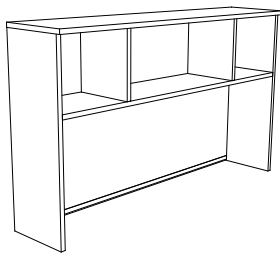

LEV-4372H

|               |         |     |     |       |       |      |
|---------------|---------|-----|-----|-------|-------|------|
| LEV-4330H     | \$621   | 81  | 3.5 | 29.5  | 15.75 | 42.5 |
| LEV-4336H     | \$676   | 83  | 3.5 | 35.5  | 15.75 | 42.5 |
| LEV-4342H     | \$744   | 92  | 4   | 41.5  | 15.75 | 42.5 |
| LEV-4348H     | \$783   | 102 | 4   | 47.25 | 15.75 | 42.5 |
| W/ 2 DIVIDERS |         |     |     |       |       |      |
| LEV-4354H     | \$853   | 113 | 4.5 | 53.25 | 15.75 | 42.5 |
| LEV-4360H     | \$921   | 123 | 5   | 59.25 | 15.75 | 42.5 |
| LEV-4366H     | \$950   | 141 | 5   | 65    | 15.75 | 42.5 |
| LEV-4372H     | \$1,084 | 158 | 6   | 71    | 15.75 | 42.5 |
| LEV-4378H     | \$1,332 | 170 | 6.5 | 77    | 15.75 | 42.5 |
| LEV-4384H     | \$1,435 | 185 | 7   | 82.75 | 15.75 | 42.5 |

- 43" HUTCHES ALIGN WITH 72" TALL STORAGE

**DOUBLE HIGH OPEN HUTCH - 48" HIGH**

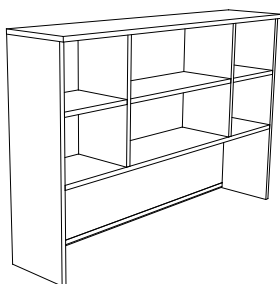

LEV-4872H

1 ADJUSTABLE SHELF

|           |         |     |     |       |       |       |
|-----------|---------|-----|-----|-------|-------|-------|
| LEV-4830H | \$888   | 110 | 3.8 | 29.5  | 15.75 | 47.25 |
| LEV-4836H | \$990   | 114 | 3.8 | 35.5  | 15.75 | 47.25 |
| LEV-4842H | \$1,059 | 126 | 4.4 | 41.5  | 15.75 | 47.25 |
| LEV-4848H | \$1,168 | 139 | 4.4 | 47.25 | 15.75 | 47.25 |

2 DIVIDERS & 3 ADJUSTABLE SHELVES.

|           |         |     |     |       |       |       |
|-----------|---------|-----|-----|-------|-------|-------|
| LEV-4854H | \$1,243 | 154 | 5   | 53.25 | 15.75 | 47.25 |
| LEV-4860H | \$1,379 | 168 | 5   | 59.25 | 15.75 | 47.25 |
| LEV-4866H | \$1,543 | 192 | 5.6 | 65    | 15.75 | 47.25 |
| LEV-4872H | \$1,640 | 216 | 6.3 | 71    | 15.75 | 47.25 |

- 48" HUTCHES ALIGN WITH 77" TALL STORAGE

**RTA**

| MODEL | LIST | *AGD<br>UPCHARGE | WEIGHT<br>LBS | CUBE<br>FT <sup>3</sup> | W<br>IN | D<br>IN | H<br>IN |
|-------|------|------------------|---------------|-------------------------|---------|---------|---------|
|-------|------|------------------|---------------|-------------------------|---------|---------|---------|

**DOUBLE HIGH OPEN HUTCH - 55" HIGH**

1 ADJUSTABLE SHELF

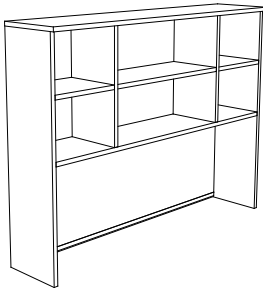

LEV-5572H

|           |                |     |     |     |       |       |       |
|-----------|----------------|-----|-----|-----|-------|-------|-------|
| LEV-5530H | <b>\$924</b>   | N/A | 115 | 3.8 | 29.5  | 15.75 | 54.25 |
| LEV-5536H | <b>\$1,040</b> | N/A | 131 | 3.8 | 35.5  | 15.75 | 54.25 |
| LEV-5542H | <b>\$1,100</b> | N/A | 147 | 4.4 | 41.5  | 15.75 | 54.25 |
| LEV-5548H | <b>\$1,218</b> | N/A | 163 | 4.4 | 47.25 | 15.75 | 54.25 |

2 DIVIDERS & 3 ADJUSTABLE SHELVES

|           |                |     |     |     |       |       |       |
|-----------|----------------|-----|-----|-----|-------|-------|-------|
| LEV-5554H | <b>\$1,463</b> | N/A | 181 | 5   | 53.25 | 15.75 | 54.25 |
| LEV-5560H | <b>\$1,551</b> | N/A | 197 | 5   | 59.25 | 15.75 | 54.25 |
| LEV-5566H | <b>\$1,648</b> | N/A | 226 | 5.6 | 65    | 15.75 | 54.25 |
| LEV-5572H | <b>\$1,720</b> | N/A | 253 | 6.3 | 71    | 15.75 | 54.25 |

- 55" HUTCHES ALIGN WITH 84" TALL STORAGE

**36" HIGH HUTCH W/ 2 DOORS**

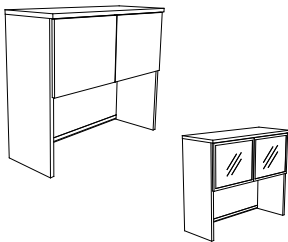

LEV-3642HHD2  
LEV-3642HHD2-AGD

|              |              |              |     |     |       |       |      |
|--------------|--------------|--------------|-----|-----|-------|-------|------|
| LEV-3630HHD2 | <b>\$792</b> | <i>\$420</i> | 79  | 3.5 | 29.5  | 15.75 | 35.5 |
| LEV-3636HHD2 | <b>\$840</b> | <i>\$466</i> | 84  | 3.5 | 35.5  | 15.75 | 35.5 |
| LEV-3642HHD2 | <b>\$896</b> | <i>\$513</i> | 94  | 4   | 41.5  | 15.75 | 35.5 |
| LEV-3648HHD2 | <b>\$955</b> | <i>\$532</i> | 105 | 4   | 47.25 | 15.75 | 35.5 |

2 DIVIDERS

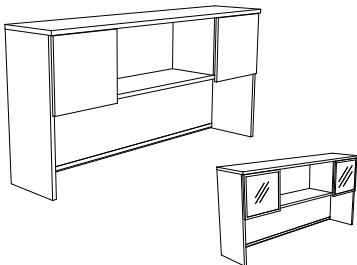

LEV-3672HHD2  
LEV-3672HHD2-AGD

|              |                |              |     |     |       |       |      |
|--------------|----------------|--------------|-----|-----|-------|-------|------|
| LEV-3654HHD2 | <b>\$1,174</b> | <i>\$420</i> | 116 | 4.5 | 53.25 | 15.75 | 35.5 |
| LEV-3660HHD2 | <b>\$1,216</b> | <i>\$466</i> | 128 | 4.5 | 59.25 | 15.75 | 35.5 |
| LEV-3666HHD2 | <b>\$1,243</b> | <i>\$513</i> | 145 | 5.5 | 65    | 15.75 | 35.5 |
| LEV-3672HHD2 | <b>\$1,393</b> | <i>\$532</i> | 163 | 6   | 71    | 15.75 | 35.5 |
| LEV-3678HHD2 | <b>\$1,742</b> | <i>\$596</i> | 180 | 7   | 77    | 15.75 | 35.5 |
| LEV-3684HHD2 | <b>\$1,886</b> | <i>\$611</i> | 198 | 7.5 | 82.75 | 15.75 | 35.5 |

- 36" HUTCHES ALIGN WITH 65" TALL STORAGE
- DOORS SHIP IN A SECOND CARTON

**36" HIGH HUTCH W/ 4 DOORS**

2 DIVIDERS

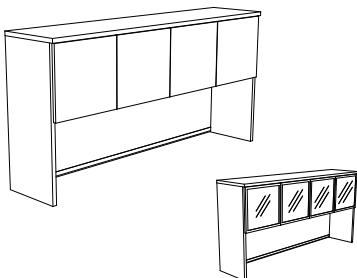

LEV-3672HHD4  
LEV-3672HHD4-AGD

|              |                |                |     |     |       |       |      |
|--------------|----------------|----------------|-----|-----|-------|-------|------|
| LEV-3654HHD4 | <b>\$1,174</b> | <i>\$814</i>   | 116 | 4.5 | 53.25 | 15.75 | 35.5 |
| LEV-3660HHD4 | <b>\$1,216</b> | <i>\$834</i>   | 128 | 4.5 | 59.25 | 15.75 | 35.5 |
| LEV-3666HHD4 | <b>\$1,243</b> | <i>\$886</i>   | 145 | 5.5 | 65    | 15.75 | 35.5 |
| LEV-3672HHD4 | <b>\$1,393</b> | <i>\$893</i>   | 163 | 6   | 71    | 15.75 | 35.5 |
| LEV-3678HHD4 | <b>\$1,742</b> | <i>\$1,019</i> | 180 | 7   | 77    | 15.75 | 35.5 |
| LEV-3684HHD4 | <b>\$1,886</b> | <i>\$1,044</i> | 198 | 7.5 | 82.75 | 15.75 | 35.5 |

- 36" HUTCHES ALIGN WITH 65" TALL STORAGE
- DOORS SHIP IN A SECOND CARTON

| MODEL | LIST      | *AGD | WEIGHT | CUBE            | W  | D  | H  |
|-------|-----------|------|--------|-----------------|----|----|----|
|       | UP CHARGE |      | LBS    | FT <sup>3</sup> | IN | IN | IN |

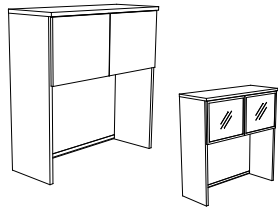

LEV-4342HHD2  
LEV-4342HHD2-AGD

**43" HIGH HUTCH W/ 2 DOORS**

|              |                |              |     |     |       |       |      |
|--------------|----------------|--------------|-----|-----|-------|-------|------|
| LEV-4330HHD2 | <b>\$851</b>   | <i>\$420</i> | 91  | 4   | 29.5  | 15.75 | 42.5 |
| LEV-4336HHD2 | <b>\$905</b>   | <i>\$466</i> | 96  | 4   | 35.5  | 15.75 | 42.5 |
| LEV-4342HHD2 | <b>\$974</b>   | <i>\$513</i> | 107 | 4.5 | 41.5  | 15.75 | 42.5 |
| LEV-4348HHD2 | <b>\$1,038</b> | <i>\$532</i> | 120 | 4.5 | 47.25 | 15.75 | 42.5 |

2 DIVIDERS

|              |                |              |     |     |       |       |      |
|--------------|----------------|--------------|-----|-----|-------|-------|------|
| LEV-4354HHD2 | <b>\$1,293</b> | <i>\$420</i> | 133 | 5.3 | 53.25 | 15.75 | 42.5 |
| LEV-4360HHD2 | <b>\$1,361</b> | <i>\$466</i> | 146 | 5.8 | 59.25 | 15.75 | 42.5 |
| LEV-4366HHD2 | <b>\$1,390</b> | <i>\$513</i> | 166 | 6   | 65    | 15.75 | 42.5 |
| LEV-4372HHD2 | <b>\$1,526</b> | <i>\$532</i> | 186 | 7   | 71    | 15.75 | 42.5 |
| LEV-4378HHD2 | <b>\$1,817</b> | <i>\$596</i> | 200 | 8   | 77    | 15.75 | 42.5 |
| LEV-4384HHD2 | <b>\$1,918</b> | <i>\$611</i> | 218 | 8.5 | 82.75 | 15.75 | 42.5 |

- 43" HUTCHES ALIGN WITH 72" TALL STORAGE
- DOORS SHIP IN A SECOND CARTON

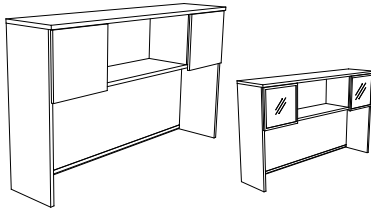

LEV-4372HHD2  
LEV-4372HHD2-AGD

**43" HIGH HUTCH W/ 4 DOORS**

2 DIVIDERS

|              |                |                |     |     |       |       |      |
|--------------|----------------|----------------|-----|-----|-------|-------|------|
| LEV-4354HHD4 | <b>\$1,293</b> | <i>\$814</i>   | 133 | 5.3 | 53.25 | 15.75 | 42.5 |
| LEV-4360HHD4 | <b>\$1,361</b> | <i>\$834</i>   | 146 | 5.8 | 59.25 | 15.75 | 42.5 |
| LEV-4366HHD4 | <b>\$1,390</b> | <i>\$886</i>   | 166 | 6   | 65    | 15.75 | 42.5 |
| LEV-4372HHD4 | <b>\$1,526</b> | <i>\$893</i>   | 186 | 7   | 71    | 15.75 | 42.5 |
| LEV-4378HHD4 | <b>\$1,817</b> | <i>\$1,019</i> | 200 | 8   | 77    | 15.75 | 42.5 |
| LEV-4384HHD4 | <b>\$1,918</b> | <i>\$1,044</i> | 218 | 8.5 | 82.75 | 15.75 | 42.5 |

- 43" HUTCHES ALIGN WITH 72" TALL STORAGE
- DOORS SHIP IN A SECOND CARTON

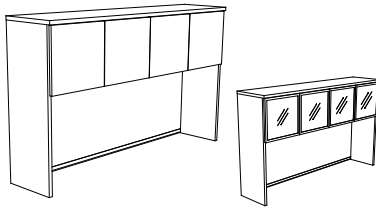

LEV-4372HHD4  
LEV-4372HHD4-AGD

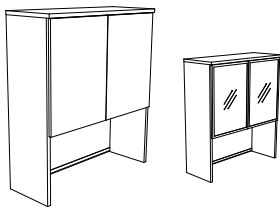

LEV-4842HHD2  
LEV-4842HHD2-AGD

**48" DOUBLE HIGH HUTCH W/ 2 DOORS**

1 ADJUSTABLE SHELF

|              |                |              |     |     |       |       |       |
|--------------|----------------|--------------|-----|-----|-------|-------|-------|
| LEV-4830HHD2 | <b>\$1,246</b> | <i>\$591</i> | 127 | 4.3 | 29.5  | 15.75 | 47.25 |
| LEV-4836HHD2 | <b>\$1,347</b> | <i>\$676</i> | 136 | 4.3 | 35.5  | 15.75 | 47.25 |
| LEV-4842HHD2 | <b>\$1,417</b> | <i>\$742</i> | 151 | 4.9 | 41.5  | 15.75 | 47.25 |
| LEV-4848HHD2 | <b>\$1,526</b> | <i>\$809</i> | 168 | 5   | 47.25 | 15.75 | 47.25 |

2 DIVIDERS & 3 ADJUSTABLE SHELVES

|              |                |              |     |     |       |       |       |
|--------------|----------------|--------------|-----|-----|-------|-------|-------|
| LEV-4854HHD2 | <b>\$1,878</b> | <i>\$591</i> | 188 | 5.7 | 53.25 | 15.75 | 47.25 |
| LEV-4860HHD2 | <b>\$2,014</b> | <i>\$676</i> | 206 | 5.8 | 59.25 | 15.75 | 47.25 |
| LEV-4866HHD2 | <b>\$2,177</b> | <i>\$742</i> | 233 | 6.4 | 65    | 15.75 | 47.25 |
| LEV-4872HHD2 | <b>\$2,276</b> | <i>\$809</i> | 261 | 7.2 | 71    | 15.75 | 47.25 |

- 48" HUTCHES ALIGN WITH 77" TALL STORAGE
- DOORS SHIP IN A SECOND CARTON

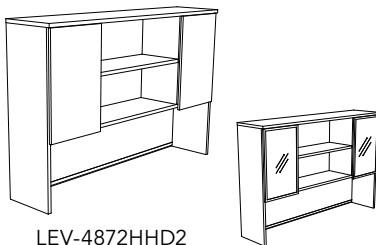

LEV-4872HHD2  
LEV-4872HHD2-AGD

RTA

**LEVELS SERIES**  
HINGED DOOR HUTCHES

| MODEL | LIST | *AGD     | WEIGHT | CUBE            | W  | D  | H  |
|-------|------|----------|--------|-----------------|----|----|----|
|       |      | UPCHARGE | LBS    | FT <sup>3</sup> | IN | IN | IN |

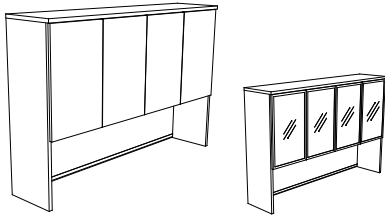

LEV-4872HHD4  
LEV-4872HHD4-AGD

**48" DOUBLE HIGH HUTCH W/ 4 DOORS**

2 DIVIDERS & 3 ADJUSTABLE SHELVES

|              |                |                |     |     |       |       |       |
|--------------|----------------|----------------|-----|-----|-------|-------|-------|
| LEV-4854HHD4 | <b>\$1,878</b> | <i>\$1,110</i> | 188 | 5.7 | 53.25 | 15.75 | 47.25 |
| LEV-4860HHD4 | <b>\$2,014</b> | <i>\$1,176</i> | 206 | 5.8 | 59.25 | 15.75 | 47.25 |
| LEV-4866HHD4 | <b>\$2,177</b> | <i>\$1,268</i> | 233 | 6.4 | 65    | 15.75 | 47.25 |
| LEV-4872HHD4 | <b>\$2,276</b> | <i>\$1,293</i> | 261 | 7.2 | 71    | 15.75 | 47.25 |

- 48" HUTCHES ALIGN WITH 77" TALL STORAGE
- DOORS SHIP IN A SECOND CARTON

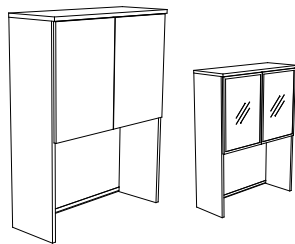

LEV-5542HHD2  
LEV-5542HHD2-AGD

**55" DOUBLE HIGH HUTCH W/ 2 DOORS**

1 ADJUSTABLE SHELF

|              |                |              |     |     |       |       |       |
|--------------|----------------|--------------|-----|-----|-------|-------|-------|
| LEV-5530HHD2 | <b>\$1,282</b> | <i>\$623</i> | 135 | 4.2 | 29.5  | 15.75 | 54.25 |
| LEV-5536HHD2 | <b>\$1,388</b> | <i>\$710</i> | 156 | 4.3 | 35.5  | 15.75 | 54.25 |
| LEV-5542HHD2 | <b>\$1,449</b> | <i>\$776</i> | 177 | 5   | 41.5  | 15.75 | 54.25 |
| LEV-5548HHD2 | <b>\$1,549</b> | <i>\$840</i> | 198 | 5.1 | 47.25 | 15.75 | 54.25 |

2 DIVIDERS & 3 ADJUSTABLE SHELVES

|              |                |              |     |     |       |       |       |
|--------------|----------------|--------------|-----|-----|-------|-------|-------|
| LEV-5554HHD2 | <b>\$1,858</b> | <i>\$623</i> | 221 | 5.8 | 53.25 | 15.75 | 54.25 |
| LEV-5560HHD2 | <b>\$1,926</b> | <i>\$710</i> | 243 | 5.9 | 59.25 | 15.75 | 54.25 |
| LEV-5566HHD2 | <b>\$2,088</b> | <i>\$776</i> | 276 | 6.6 | 65    | 15.75 | 54.25 |
| LEV-5572HHD2 | <b>\$2,140</b> | <i>\$840</i> | 308 | 7.4 | 71    | 15.75 | 54.25 |

- 55" HUTCHES ALIGN WITH 84" TALL STORAGE
- DOORS SHIP IN A SECOND CARTON

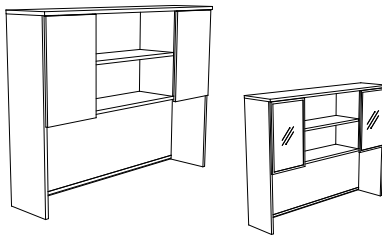

LEV-5572HHD2  
LEV-5572HHD2-AGD

**55" DOUBLE HIGH HUTCH W/ 4 DOORS**

2 DIVIDERS & 3 ADJUSTABLE SHELVES

|              |                |                |     |     |       |       |       |
|--------------|----------------|----------------|-----|-----|-------|-------|-------|
| LEV-5554HHD4 | <b>\$1,858</b> | <i>\$1,143</i> | 221 | 5.8 | 53.25 | 15.75 | 54.25 |
| LEV-5560HHD4 | <b>\$1,926</b> | <i>\$1,208</i> | 243 | 5.9 | 59.25 | 15.75 | 54.25 |
| LEV-5566HHD4 | <b>\$2,088</b> | <i>\$1,301</i> | 276 | 6.6 | 65    | 15.75 | 54.25 |
| LEV-5572HHD4 | <b>\$2,140</b> | <i>\$1,307</i> | 308 | 7.4 | 71    | 15.75 | 54.25 |

- 55" HUTCHES ALIGN WITH 84" TALL STORAGE
- DOORS SHIP IN A SECOND CARTON

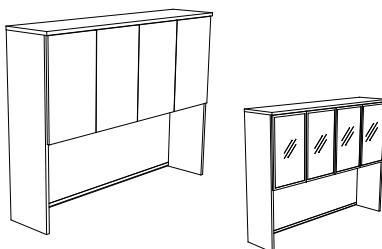

LEV-5572HHD4  
LEV-5572HHD4-AGD

**RTA**

| MODEL | LIST | WEIGHT | CUBE            | W  | D  | H  |
|-------|------|--------|-----------------|----|----|----|
|       |      | LBS    | FT <sup>3</sup> | IN | IN | IN |

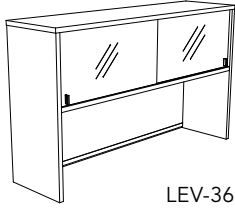

LEV-3660HBD

**36" HUTCH W/ LAMINATE GABLES & PLEXI BI-PASS DOORS**

W/ 1 DIVIDERS

|                    |                |       |      |       |       |      |
|--------------------|----------------|-------|------|-------|-------|------|
| <b>LEV-3660HBD</b> | <b>\$1,651</b> | 116.5 | 3.25 | 59.25 | 15.75 | 35.5 |
|--------------------|----------------|-------|------|-------|-------|------|

W/ 2 DIVIDERS

|                    |                |       |      |    |       |      |
|--------------------|----------------|-------|------|----|-------|------|
| <b>LEV-3672HBD</b> | <b>\$1,889</b> | 136.8 | 3.73 | 71 | 15.75 | 35.5 |
|--------------------|----------------|-------|------|----|-------|------|

- 36" HUTCHES ALIGN WITH 65" TALL STORAGE
- SMALL BAR HANDLES

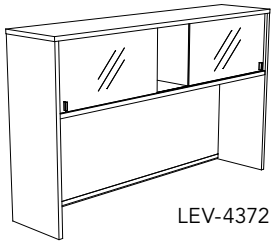

LEV-4372HBD

**43" HUTCH W/ LAMINATE GABLES & PLEXI BI-PASS DOORS**

W/ 1 DIVIDERS

|                    |                |       |      |       |       |      |
|--------------------|----------------|-------|------|-------|-------|------|
| <b>LEV-4360HBD</b> | <b>\$1,750</b> | 129.3 | 3.54 | 59.25 | 15.75 | 42.5 |
|--------------------|----------------|-------|------|-------|-------|------|

W/ 2 DIVIDERS

|                    |                |       |      |    |       |      |
|--------------------|----------------|-------|------|----|-------|------|
| <b>LEV-4372HBD</b> | <b>\$2,042</b> | 151.1 | 4.02 | 71 | 15.75 | 42.5 |
|--------------------|----------------|-------|------|----|-------|------|

- 43" HUTCHES ALIGN WITH 72" TALL STORAGE
- SMALL BAR HANDLES

**HUTCHES WITH SLIDING DOOR**

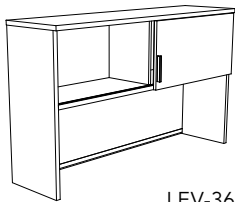

LEV-3660HSD

**36" HIGH HUTCH W/ SLIDING DOOR**

W/ 1 DIVIDERS

|                    |                |     |      |       |       |      |
|--------------------|----------------|-----|------|-------|-------|------|
| <b>LEV-3660HSD</b> | <b>\$1,209</b> | 123 | 22.8 | 59.25 | 15.75 | 35.5 |
|--------------------|----------------|-----|------|-------|-------|------|

W/ 2 DIVIDERS

|                    |                |       |      |    |       |      |
|--------------------|----------------|-------|------|----|-------|------|
| <b>LEV-3672HSD</b> | <b>\$1,340</b> | 135.9 | 27.2 | 71 | 15.75 | 35.5 |
|--------------------|----------------|-------|------|----|-------|------|

- 36" HUTCHES ALIGN WITH 65" TALL STORAGE
- HANDLE ON THE LEFT

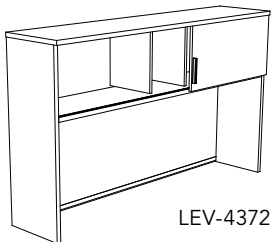

LEV-4372HSD

**43" HIGH HUTCH W/ SLIDING DOOR**

W/ 1 DIVIDERS

|                    |                |       |      |       |       |      |
|--------------------|----------------|-------|------|-------|-------|------|
| <b>LEV-4360HSD</b> | <b>\$1,412</b> | 130.4 | 27.1 | 59.25 | 15.75 | 42.5 |
|--------------------|----------------|-------|------|-------|-------|------|

W/ 2 DIVIDERS

|                    |                |       |      |    |       |      |
|--------------------|----------------|-------|------|----|-------|------|
| <b>LEV-4372HSD</b> | <b>\$1,526</b> | 149.9 | 32.4 | 71 | 15.75 | 42.5 |
|--------------------|----------------|-------|------|----|-------|------|

- 43" HUTCHES ALIGN WITH 72" TALL STORAGE
- HANDLE ON THE LEFT

**RTA**

| MODEL | LIST | WEIGHT | CUBE            | W  | D  | H  |
|-------|------|--------|-----------------|----|----|----|
|       |      | LBS    | FT <sup>3</sup> | IN | IN | IN |

**TACKBOARD FOR 36" & 48" HUTCHES OR WALL MOUNT APPLICATIONS**

|            |       |    |     |       |   |       |
|------------|-------|----|-----|-------|---|-------|
| LEV-3630TB | \$226 | 10 | 1   | 26.5  | 1 | 14.75 |
| LEV-3636TB | \$237 | 11 | 1   | 32.5  | 1 | 14.75 |
| LEV-3642TB | \$298 | 12 | 1   | 38.5  | 1 | 14.75 |
| LEV-3648TB | \$307 | 12 | 1   | 44.75 | 1 | 14.75 |
| LEV-3654TB | \$316 | 13 | 2   | 50.25 | 1 | 14.75 |
| LEV-3660TB | \$325 | 15 | 2   | 56.25 | 1 | 14.75 |
| LEV-3666TB | \$334 | 16 | 2   | 62    | 1 | 14.75 |
| LEV-3672TB | \$357 | 17 | 2   | 68    | 1 | 14.75 |
| LEV-3678TB | \$436 | 18 | 2.5 | 74    | 1 | 14.75 |
| LEV-3684TB | \$463 | 19 | 2.5 | 79.75 | 1 | 14.75 |

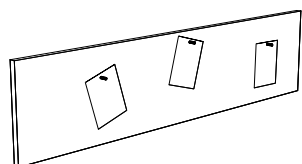

LEV-3672TB

- MOUNTING CLIPS INCLUDED
- FOR LAMINATE BACK HUTCHES OR WALL MOUNT APPLICATIONS
- CAN NOT BE INSTALLED ON HUTCHES WITH METAL SUPPORTS

**TACKBOARD FOR 43" & 55" HUTCHES OR WALL MOUNT APPLICATIONS**

|            |       |    |     |       |   |       |
|------------|-------|----|-----|-------|---|-------|
| LEV-4330TB | \$279 | 11 | 1   | 26.5  | 1 | 21.75 |
| LEV-4336TB | \$290 | 12 | 1   | 32.5  | 1 | 21.75 |
| LEV-4342TB | \$342 | 13 | 1   | 38.5  | 1 | 21.75 |
| LEV-4348TB | \$353 | 13 | 2   | 44.75 | 1 | 21.75 |
| LEV-4354TB | \$360 | 14 | 2   | 50.25 | 1 | 21.75 |
| LEV-4360TB | \$370 | 16 | 2   | 56.25 | 1 | 21.75 |
| LEV-4366TB | \$381 | 17 | 2   | 62    | 1 | 21.75 |
| LEV-4372TB | \$387 | 18 | 2   | 68    | 1 | 21.75 |
| LEV-4378TB | \$463 | 19 | 2.5 | 74    | 1 | 21.75 |
| LEV-4384TB | \$516 | 20 | 2.5 | 79.75 | 1 | 21.75 |

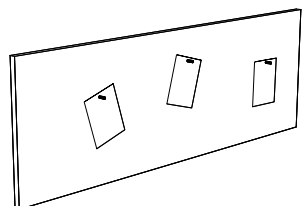

LEV-4372TB

- MOUNTING CLIPS INCLUDED
- FOR LAMINATE BACK HUTCHES OR WALL MOUNT APPLICATIONS
- CAN NOT BE INSTALLED ON HUTCHES WITH METAL SUPPORTS

**RTA**

**NOTE:** PLEASE REFER TO THE FINISHES & FABRICS TAB ON THE WWW.HEARTWOOD.CA WEBSITE FOR A COMPLETE LISTING OF CURRENT FABRIC FINISHES.

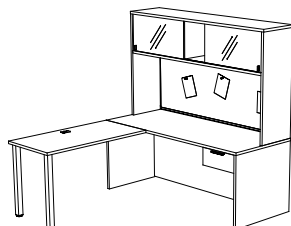

| HUTCH APPLICATION |  |
|-------------------|--|
| LEV-4372HBD       | 43" HUTCH W/ LAMINATE GABLES & PLEXI BI-PASS DOORS         |
| LEV-4372TB        | TACKBOARD FOR 43" & 55" HUTCHES OR WALL MOUNT APPLICATIONS |
| LEV-3072DS        | DESK SHELL - 30" DESK, MODESTY PANEL RECESSED 4"           |
| LEV-2448RET-SQ2   | RECTANGULAR BULLET RETURN                                  |
| LEV-HPB           | HANGING PEDESTAL - BOX, NO LOCK                            |

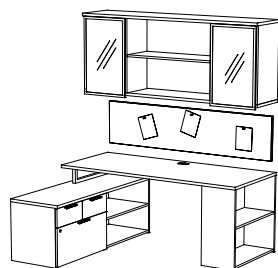

| WALL APPLICATION  |   |
|-------------------|---|
| LEV-TR3072-COX    | TIERED RECTANGULAR BULLET RETURN                                |
| LEV-BBLF2060CO-22 | 22" HIGH BOX/BOX/WIDE DRAWER/LATERAL FILE OPEN CABINET CREDENZA |
| LEV-3672TB        | TACKBOARD FOR 36" & 48" HUTCHES OR WALL MOUNT APPLICATIONS      |
| LEV-2972OSHD2-AGD | DOUBLE HIGH OVERHEAD STORAGE - W/ 2 DOORS                       |



| MODEL | LIST | WEIGHT | CUBE            | W  | D  | H  |
|-------|------|--------|-----------------|----|----|----|
|       |      | LBS    | FT <sup>3</sup> | IN | IN | IN |

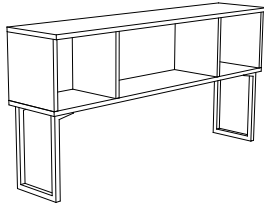

LEV-3672MH

**OPEN HUTCH 36" HIGH W/ 19" METAL SUPPORTS**

|            |              |      |      |       |       |      |
|------------|--------------|------|------|-------|-------|------|
| LEV-3636MH | <b>\$731</b> | 55.2 | 3.79 | 35.5  | 15.75 | 35.5 |
| LEV-3642MH | <b>\$752</b> | 61.4 | 4.29 | 41.5  | 15.75 | 35.5 |
| LEV-3648MH | <b>\$757</b> | 67.6 | 4.29 | 47.25 | 15.75 | 35.5 |

W/ 2 DIVIDERS

|            |                |       |      |       |       |      |
|------------|----------------|-------|------|-------|-------|------|
| LEV-3654MH | <b>\$763</b>   | 84.5  | 4.79 | 53.25 | 15.75 | 35.5 |
| LEV-3660MH | <b>\$769</b>   | 90.7  | 4.79 | 59.25 | 15.75 | 35.5 |
| LEV-3666MH | <b>\$937</b>   | 96.9  | 5.29 | 65    | 15.75 | 35.5 |
| LEV-3672MH | <b>\$1,020</b> | 103.2 | 5.79 | 71    | 15.75 | 35.5 |
| LEV-3678MH | <b>\$1,141</b> | 109.4 | 6.29 | 77    | 15.75 | 35.5 |
| LEV-3684MH | <b>\$1,270</b> | 115.7 | 6.79 | 82.75 | 15.75 | 35.5 |

- 36" HUTCHES ALIGN WITH 65" TALL STORAGE

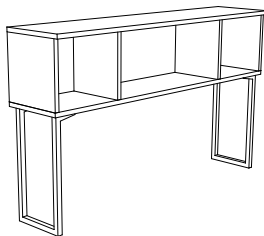

LEV-4372MH

**OPEN HUTCH 43" HIGH W/ 26" METAL SUPPORTS**

|            |              |      |      |       |       |      |
|------------|--------------|------|------|-------|-------|------|
| LEV-4330MH | <b>\$795</b> | 50.7 | 4.58 | 29.75 | 15.75 | 42.5 |
| LEV-4336MH | <b>\$814</b> | 56.9 | 4.58 | 35.5  | 15.75 | 42.5 |
| LEV-4342MH | <b>\$818</b> | 63.2 | 5.08 | 41.5  | 15.75 | 42.5 |
| LEV-4348MH | <b>\$827</b> | 69.4 | 5.08 | 47.25 | 15.75 | 42.5 |

W/ 2 DIVIDERS

|            |                |       |      |       |       |      |
|------------|----------------|-------|------|-------|-------|------|
| LEV-4354MH | <b>\$831</b>   | 86.2  | 5.58 | 53.25 | 15.75 | 42.5 |
| LEV-4360MH | <b>\$1,000</b> | 92.5  | 6.08 | 59.25 | 15.75 | 42.5 |
| LEV-4366MH | <b>\$1,081</b> | 98.7  | 6.08 | 65    | 15.75 | 42.5 |
| LEV-4372MH | <b>\$1,202</b> | 104.9 | 7.08 | 71    | 15.75 | 42.5 |
| LEV-4378MH | <b>\$1,332</b> | 111.2 | 7.58 | 77    | 15.75 | 42.5 |
| LEV-4384MH | <b>\$1,397</b> | 117.4 | 8.08 | 82.75 | 15.75 | 42.5 |

- 43" HUTCHES ALIGN WITH 72" TALL STORAGE

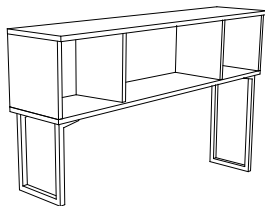

LEV-TR4372MH-L

**TIERED OPEN HUTCH 43" HIGH W/ 19" & 26" METAL SUPPORTS**

|              |              |      |      |       |       |      |
|--------------|--------------|------|------|-------|-------|------|
| LEV-TR4330MH | <b>\$781</b> | 49.8 | 4.43 | 29.75 | 15.75 | 42.5 |
| LEV-TR4336MH | <b>\$801</b> | 56   | 4.43 | 35.5  | 15.75 | 42.5 |
| LEV-TR4342MH | <b>\$806</b> | 62.3 | 4.93 | 41.5  | 15.75 | 42.5 |
| LEV-TR4348MH | <b>\$814</b> | 68.5 | 4.93 | 47.25 | 15.75 | 42.5 |

W/ 2 DIVIDERS

|              |                |       |      |       |       |      |
|--------------|----------------|-------|------|-------|-------|------|
| LEV-TR4354MH | <b>\$817</b>   | 85.3  | 5.43 | 53.25 | 15.75 | 42.5 |
| LEV-TR4360MH | <b>\$988</b>   | 91.6  | 5.93 | 59.25 | 15.75 | 42.5 |
| LEV-TR4366MH | <b>\$1,070</b> | 97.8  | 5.93 | 65    | 15.75 | 42.5 |
| LEV-TR4372MH | <b>\$1,191</b> | 104.1 | 6.93 | 71    | 15.75 | 42.5 |
| LEV-TR4378MH | <b>\$1,319</b> | 110.3 | 7.43 | 77    | 15.75 | 42.5 |
| LEV-TR4384MH | <b>\$1,385</b> | 116.5 | 7.93 | 82.75 | 15.75 | 42.5 |

- 43" HUTCHES ALIGN WITH 72" TALL STORAGE
- METAL SUPPORT INSTALL IS NON-HANDED

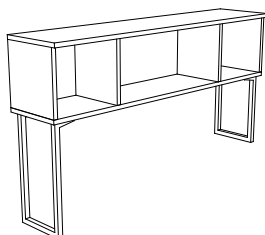

LEV-TR4372MH-R

**RTA**

# LEVELS SERIES

## HUTCHES WITH METAL SUPPORTS

| MODEL | LIST     | *AGD | WEIGHT | CUBE            | W  | D  | H  |
|-------|----------|------|--------|-----------------|----|----|----|
|       | UPCHARGE |      | LBS    | FT <sup>3</sup> | IN | IN | IN |

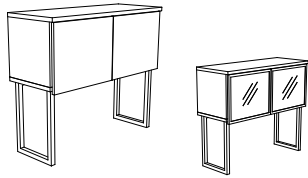

LEV-3642MHHD2  
LEV-3642MHHD2-AGD

### 36" HIGH HUTCH W/ 2 DOORS WITH 19" METAL SUPPORTS

|               |                |              |      |      |       |       |      |
|---------------|----------------|--------------|------|------|-------|-------|------|
| LEV-3630MHHD2 | <b>\$898</b>   | <i>\$420</i> | 57.5 | 4.29 | 29.75 | 15.75 | 35.5 |
| LEV-3636MHHD2 | <b>\$946</b>   | <i>\$466</i> | 65.5 | 4.29 | 35.5  | 15.75 | 35.5 |
| LEV-3642MHHD2 | <b>\$1,002</b> | <i>\$513</i> | 73.5 | 4.79 | 41.5  | 15.75 | 35.5 |
| LEV-3648MHHD2 | <b>\$1,061</b> | <i>\$532</i> | 81.5 | 4.79 | 47.25 | 15.75 | 35.5 |

### 2 DIVIDERS

|               |                |              |       |      |       |       |      |
|---------------|----------------|--------------|-------|------|-------|-------|------|
| LEV-3654MHHD2 | <b>\$1,280</b> | <i>\$420</i> | 92.3  | 5.29 | 53.25 | 15.75 | 35.5 |
| LEV-3660MHHD2 | <b>\$1,322</b> | <i>\$466</i> | 99.4  | 5.29 | 59.25 | 15.75 | 35.5 |
| LEV-3666MHHD2 | <b>\$1,350</b> | <i>\$513</i> | 106.5 | 6.29 | 65    | 15.75 | 35.5 |
| LEV-3672MHHD2 | <b>\$1,499</b> | <i>\$532</i> | 113.7 | 6.79 | 71    | 15.75 | 35.5 |
| LEV-3678MHHD2 | <b>\$1,786</b> | <i>\$596</i> | 120.8 | 7.79 | 77    | 15.75 | 35.5 |
| LEV-3684MHHD2 | <b>\$1,915</b> | <i>\$611</i> | 127.9 | 8.29 | 82.75 | 15.75 | 35.5 |

- 36" HUTCHES ALIGN WITH 65" TALL STORAGE
- DOORS SHIP IN A SECOND CARTON

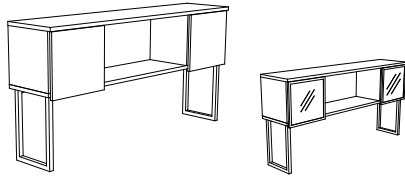

LEV-3672MHHD2  
LEV-3672MHHD2-AGD

### 36" HIGH HUTCH W/ 4 DOORS WITH 19" METAL SUPPORTS

### 2 DIVIDERS

|               |                |                |       |      |       |       |      |
|---------------|----------------|----------------|-------|------|-------|-------|------|
| LEV-3654MHHD4 | <b>\$1,280</b> | <i>\$814</i>   | 100.1 | 5.29 | 53.25 | 15.75 | 35.5 |
| LEV-3660MHHD4 | <b>\$1,322</b> | <i>\$834</i>   | 108.1 | 5.29 | 59.25 | 15.75 | 35.5 |
| LEV-3666MHHD4 | <b>\$1,350</b> | <i>\$886</i>   | 116.1 | 6.29 | 65    | 15.75 | 35.5 |
| LEV-3672MHHD4 | <b>\$1,499</b> | <i>\$893</i>   | 124.2 | 6.79 | 71    | 15.75 | 35.5 |
| LEV-3678MHHD4 | <b>\$1,849</b> | <i>\$1,019</i> | 132.2 | 7.79 | 77    | 15.75 | 35.5 |
| LEV-3684MHHD4 | <b>\$1,941</b> | <i>\$1,044</i> | 140.2 | 8.29 | 82.75 | 15.75 | 35.5 |

- 36" HUTCHES ALIGN WITH 65" TALL STORAGE
- DOORS SHIP IN A SECOND CARTON

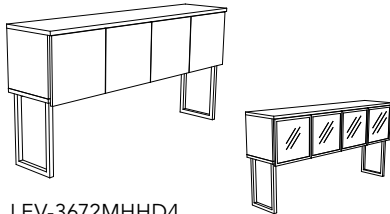

LEV-3672MHHD4  
LEV-3672MHHD4-AGD

### 43" HIGH HUTCH W/ 2 DOORS WITH 26" METAL SUPPORTS

|               |                |              |      |      |       |       |      |
|---------------|----------------|--------------|------|------|-------|-------|------|
| LEV-4330MHHD2 | <b>\$935</b>   | <i>\$420</i> | 59.2 | 5.08 | 29.75 | 15.75 | 42.5 |
| LEV-4336MHHD2 | <b>\$983</b>   | <i>\$466</i> | 67.2 | 5.08 | 35.5  | 15.75 | 42.5 |
| LEV-4342MHHD2 | <b>\$1,038</b> | <i>\$513</i> | 75.3 | 5.58 | 41.5  | 15.75 | 42.5 |
| LEV-4348MHHD2 | <b>\$1,098</b> | <i>\$532</i> | 83.3 | 5.58 | 47.25 | 15.75 | 42.5 |

### 2 DIVIDERS

|               |                |              |       |      |       |       |      |
|---------------|----------------|--------------|-------|------|-------|-------|------|
| LEV-4354MHHD2 | <b>\$1,317</b> | <i>\$420</i> | 94    | 6.38 | 53.25 | 15.75 | 42.5 |
| LEV-4360MHHD2 | <b>\$1,358</b> | <i>\$466</i> | 101.2 | 6.88 | 59.25 | 15.75 | 42.5 |
| LEV-4366MHHD2 | <b>\$1,385</b> | <i>\$513</i> | 108.3 | 7.08 | 65    | 15.75 | 42.5 |
| LEV-4372MHHD2 | <b>\$1,535</b> | <i>\$532</i> | 115.4 | 8.08 | 71    | 15.75 | 42.5 |
| LEV-4378MHHD2 | <b>\$1,822</b> | <i>\$596</i> | 122.6 | 9.08 | 77    | 15.75 | 42.5 |
| LEV-4384MHHD2 | <b>\$1,951</b> | <i>\$611</i> | 129.7 | 9.58 | 82.75 | 15.75 | 42.5 |

- 43" HUTCHES ALIGN WITH 72" TALL STORAGE
- DOORS SHIP IN A SECOND CARTON

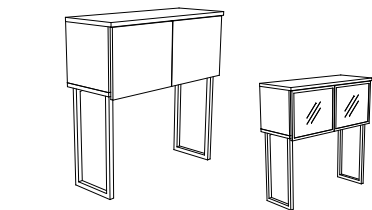

LEV-4342MHHD2  
LEV-4342MHHD2-AGD

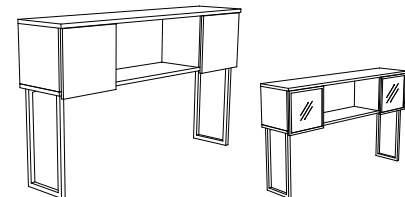

LEV-4372MHHD2  
LEV-4372MHHD2-AGD

RTA

| MODEL | LIST      | *AGD | WEIGHT | CUBE            | W  | D  | H  |
|-------|-----------|------|--------|-----------------|----|----|----|
|       | UP CHARGE |      | LBS    | FT <sup>3</sup> | IN | IN | IN |

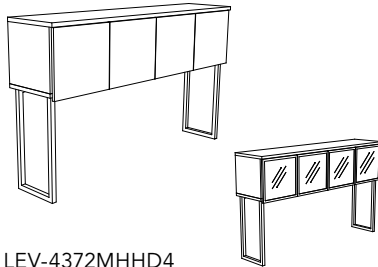

LEV-4372MHHD4  
LEV-4372MHHD4-AGD

**43" HIGH HUTCH W/ 4 DOORS WITH 26" METAL SUPPORTS**

2 DIVIDERS

|               |                |                |       |      |       |       |      |
|---------------|----------------|----------------|-------|------|-------|-------|------|
| LEV-4354MHHD4 | <b>\$1,317</b> | <i>\$814</i>   | 101.8 | 6.38 | 53.25 | 15.75 | 42.5 |
| LEV-4360MHHD4 | <b>\$1,358</b> | <i>\$834</i>   | 109.9 | 6.88 | 59.25 | 15.75 | 42.5 |
| LEV-4366MHHD4 | <b>\$1,385</b> | <i>\$886</i>   | 117.9 | 7.08 | 65    | 15.75 | 42.5 |
| LEV-4372MHHD4 | <b>\$1,535</b> | <i>\$893</i>   | 125.9 | 8.08 | 71    | 15.75 | 42.5 |
| LEV-4378MHHD4 | <b>\$1,886</b> | <i>\$1,019</i> | 133.9 | 9.08 | 77    | 15.75 | 42.5 |
| LEV-4384MHHD4 | <b>\$1,977</b> | <i>\$1,044</i> | 142   | 9.58 | 82.75 | 15.75 | 42.5 |

- 43" HUTCHES ALIGN WITH 72" TALL STORAGE
- DOORS SHIP IN A SECOND CARTON

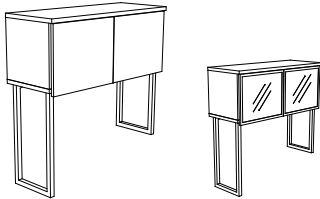

LEV-TR4342MHHD2-R  
LEV-TR4342MHHD2-R-AGD

**TIERED 43" HIGH HUTCH W/ 2 DOORS WITH 19" & 26" METAL SUPPORTS**

|                 |                |              |      |      |       |       |      |
|-----------------|----------------|--------------|------|------|-------|-------|------|
| LEV-TR4330MHHD2 | <b>\$921</b>   | <i>\$420</i> | 58.3 | 4.93 | 29.75 | 15.75 | 42.5 |
| LEV-TR4336MHHD2 | <b>\$971</b>   | <i>\$466</i> | 66.4 | 4.93 | 35.5  | 15.75 | 42.5 |
| LEV-TR4342MHHD2 | <b>\$1,025</b> | <i>\$513</i> | 74.4 | 5.43 | 41.5  | 15.75 | 42.5 |
| LEV-TR4348MHHD2 | <b>\$1,084</b> | <i>\$532</i> | 82.4 | 5.43 | 47.25 | 15.75 | 42.5 |

2 DIVIDERS

|                 |                |              |       |      |       |       |      |
|-----------------|----------------|--------------|-------|------|-------|-------|------|
| LEV-TR4354MHHD2 | <b>\$1,304</b> | <i>\$420</i> | 93.1  | 6.23 | 53.25 | 15.75 | 42.5 |
| LEV-TR4360MHHD2 | <b>\$1,344</b> | <i>\$466</i> | 100.3 | 6.73 | 59.25 | 15.75 | 42.5 |
| LEV-TR4366MHHD2 | <b>\$1,373</b> | <i>\$513</i> | 107.4 | 6.93 | 65    | 15.75 | 42.5 |
| LEV-TR4372MHHD2 | <b>\$1,523</b> | <i>\$532</i> | 114.5 | 7.93 | 71    | 15.75 | 42.5 |
| LEV-TR4378MHHD2 | <b>\$1,809</b> | <i>\$596</i> | 121.7 | 8.93 | 77    | 15.75 | 42.5 |
| LEV-TR4384MHHD2 | <b>\$1,940</b> | <i>\$611</i> | 128.8 | 9.43 | 82.75 | 15.75 | 42.5 |

- 43" HUTCHES ALIGN WITH 72" TALL STORAGE
- DOORS SHIP IN A SECOND CARTON
- METAL SUPPORT INSTALL IS NON-HANDED

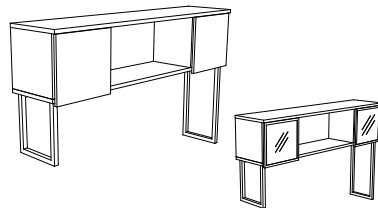

LEV-TR4372MHHD2-L  
LEV-TR4372MHHD2-L-AGD

**TIERED 43" HIGH HUTCH W/ 4 DOORS WITH 19" & 26" METAL SUPPORTS**

2 DIVIDERS

|                 |                |                |       |      |       |       |      |
|-----------------|----------------|----------------|-------|------|-------|-------|------|
| LEV-TR4354MHHD4 | <b>\$1,304</b> | <i>\$814</i>   | 100.9 | 6.23 | 53.25 | 15.75 | 42.5 |
| LEV-TR4360MHHD4 | <b>\$1,344</b> | <i>\$834</i>   | 109   | 6.73 | 59.25 | 15.75 | 42.5 |
| LEV-TR4366MHHD4 | <b>\$1,373</b> | <i>\$886</i>   | 117   | 6.93 | 65    | 15.75 | 42.5 |
| LEV-TR4372MHHD4 | <b>\$1,523</b> | <i>\$893</i>   | 125   | 7.93 | 71    | 15.75 | 42.5 |
| LEV-TR4378MHHD4 | <b>\$1,872</b> | <i>\$1,019</i> | 133.1 | 8.93 | 77    | 15.75 | 42.5 |
| LEV-TR4384MHHD4 | <b>\$1,965</b> | <i>\$1,044</i> | 141.1 | 9.43 | 82.75 | 15.75 | 42.5 |

- 43" HUTCHES ALIGN WITH 72" TALL STORAGE
- DOORS SHIP IN A SECOND CARTON
- METAL SUPPORT INSTALL IS NON-HANDED

**RTA**

# LEVELS SERIES

## HUTCHES WITH PLEXI BI-PASS DOORS & METAL SUPPORTS

| MODEL | LIST | WEIGHT | CUBE | W | D | H |
|-------|------|--------|------|---|---|---|
|       |      |        |      |   |   |   |

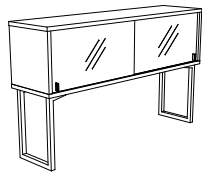

LEV-3660MHBD

### 36" HIGH HUTCH W/ 19" METAL SUPPORTS & PLEXI BI-PASS DOORS

1 DIVIDER

|              |         |      |      |       |    |      |
|--------------|---------|------|------|-------|----|------|
| LEV-3660MHBD | \$1,664 | 88.2 | 3.14 | 59.25 | 15 | 35.5 |
|--------------|---------|------|------|-------|----|------|

2 DIVIDERS, OPEN CENTER SECTION

|              |         |       |      |    |    |      |
|--------------|---------|-------|------|----|----|------|
| LEV-3672MHBD | \$1,924 | 104.1 | 3.59 | 71 | 15 | 35.5 |
|--------------|---------|-------|------|----|----|------|

- 36" HUTCHES ALIGN WITH 65" TALL STORAGE
- DOORS HAVE HANDLES

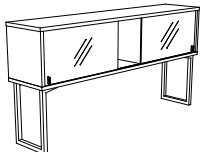

LEV-3672MHBD

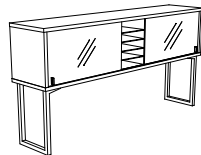

- TO ADD A SET OF 4 PLEXI COLLATOR SHELVES, **ADD '-COL' TO ITEM #** & ADD **\$369** TO RETAIL PRICE 72" HUTCHES ONLY  
**Example:** WRK-3672MHBD-COL

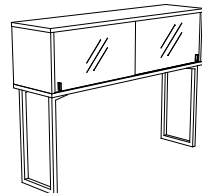

LEV-4360MHBD

### 43" HIGH HUTCH W/ 26" METAL SUPPORTS & PLEXI BI-PASS DOORS

1 DIVIDER

|              |         |      |      |       |    |      |
|--------------|---------|------|------|-------|----|------|
| LEV-4360MHBD | \$2,055 | 88.2 | 3.43 | 59.25 | 15 | 42.5 |
|--------------|---------|------|------|-------|----|------|

2 DIVIDERS, OPEN CENTER SECTION

|              |         |       |      |    |    |      |
|--------------|---------|-------|------|----|----|------|
| LEV-4372MHBD | \$2,094 | 104.1 | 3.89 | 71 | 15 | 42.5 |
|--------------|---------|-------|------|----|----|------|

- 43" HUTCHES ALIGN WITH 72" TALL STORAGE
- DOORS HAVE HANDLES

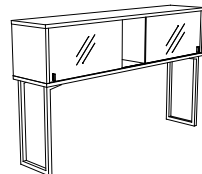

LEV-4372MHBD

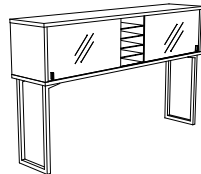

- TO ADD A SET OF 4 PLEXI COLLATOR SHELVES, **ADD '-COL' TO ITEM #** & ADD **\$369** TO RETAIL PRICE 72" HUTCHES ONLY  
**Example:** LEV-4372MHBD-COL

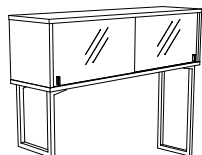

LEV-TR4360MHBD-R

### 43" HIGH TIERED HUTCH W/ 19" & 26" METAL SUPPORTS & PLEXI BI-PASS DOORS

1 DIVIDER

|                |         |      |      |       |    |      |
|----------------|---------|------|------|-------|----|------|
| LEV-TR4360MHBD | \$2,044 | 88.2 | 3.28 | 59.25 | 15 | 42.5 |
|----------------|---------|------|------|-------|----|------|

2 DIVIDERS, OPEN CENTER SECTION

|                |         |       |      |    |    |      |
|----------------|---------|-------|------|----|----|------|
| LEV-TR4372MHBD | \$2,081 | 104.1 | 3.74 | 71 | 15 | 42.5 |
|----------------|---------|-------|------|----|----|------|

- 43" HUTCHES ALIGN WITH 72" TALL STORAGE
- DOORS HAVE HANDLES

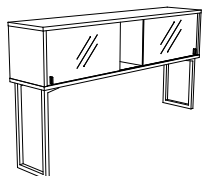

LEV-TR4372MHBD-L

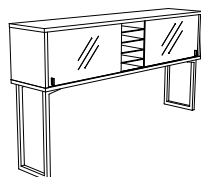

- TO ADD A SET OF 4 PLEXI COLLATOR SHELVES, **ADD '-COL' TO ITEM #** & ADD **\$369** TO RETAIL PRICE 72" HUTCHES ONLY  
**Example:** LEV-TR4372MHBD-COL

RTA

| MODEL | LIST | WEIGHT | CUBE            | W  | D  | H  |
|-------|------|--------|-----------------|----|----|----|
|       |      | LBS    | FT <sup>3</sup> | IN | IN | IN |

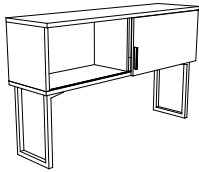

LEV-3660MHSD

**36" HIGH HUTCH W/ 19" METAL SUPPORTS & SLIDING DOOR**

1 DIVIDER

|                     |                |             |             |              |              |             |
|---------------------|----------------|-------------|-------------|--------------|--------------|-------------|
| <b>LEV-3660MHSD</b> | <b>\$1,268</b> | <b>97.3</b> | <b>3.25</b> | <b>59.25</b> | <b>15.75</b> | <b>35.5</b> |
|---------------------|----------------|-------------|-------------|--------------|--------------|-------------|

2 DIVIDERS, OPEN CENTER SECTION

|                     |                |              |             |           |              |             |
|---------------------|----------------|--------------|-------------|-----------|--------------|-------------|
| <b>LEV-3672MHSD</b> | <b>\$1,517</b> | <b>113.2</b> | <b>3.73</b> | <b>71</b> | <b>15.75</b> | <b>35.5</b> |
|---------------------|----------------|--------------|-------------|-----------|--------------|-------------|

- 36" HUTCHES ALIGN WITH 65" TALL STORAGE
- HANDLES ON THE LEFT

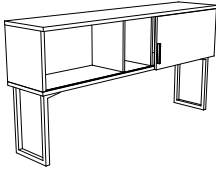

LEV-3672MHSD

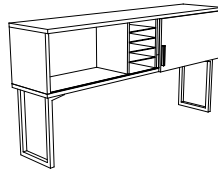

- TO ADD A SET OF 4 PLEXI COLLATOR SHELVES, **ADD '-COL' TO ITEM #** & ADD **\$369** TO RETAIL PRICE 72" HUTCHES ONLY  
**Example:** LEV-3672MHSD-COL

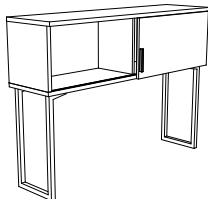

LEV-4360MHSD

**43" HIGH HUTCH W/ 26" METAL SUPPORTS & SLIDING DOOR**

1 DIVIDER

|                     |                |             |             |              |              |             |
|---------------------|----------------|-------------|-------------|--------------|--------------|-------------|
| <b>LEV-4360MHSD</b> | <b>\$1,454</b> | <b>99.1</b> | <b>3.54</b> | <b>59.25</b> | <b>15.75</b> | <b>42.5</b> |
|---------------------|----------------|-------------|-------------|--------------|--------------|-------------|

2 DIVIDERS, OPEN CENTER SECTION

|                     |                |            |             |           |              |             |
|---------------------|----------------|------------|-------------|-----------|--------------|-------------|
| <b>LEV-4372MHSD</b> | <b>\$1,703</b> | <b>115</b> | <b>4.02</b> | <b>71</b> | <b>15.75</b> | <b>42.5</b> |
|---------------------|----------------|------------|-------------|-----------|--------------|-------------|

- 43" HUTCHES ALIGN WITH 72" TALL STORAGE
- HANDLES ON THE LEFT

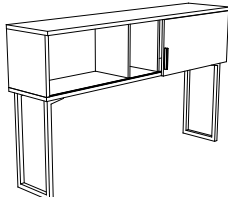

LEV-4372MHSD

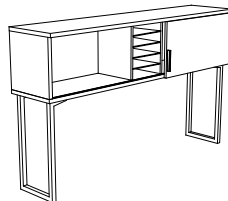

- TO ADD A SET OF 4 PLEXI COLLATOR SHELVES, **ADD '-COL' TO ITEM #** & ADD **\$369** TO RETAIL PRICE 72" HUTCHES ONLY  
**Example:** LEV-4372MHSD-COL

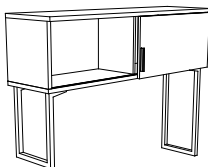

LEV-TR4360MHSD

**43" HIGH TIERED HUTCH W/ 19" & 26" METAL SUPPORTS & SLIDING DOOR**

1 DIVIDER

|                       |                |             |            |              |              |             |
|-----------------------|----------------|-------------|------------|--------------|--------------|-------------|
| <b>LEV-TR4360MHSD</b> | <b>\$1,442</b> | <b>99.1</b> | <b>3.3</b> | <b>59.25</b> | <b>15.75</b> | <b>42.5</b> |
|-----------------------|----------------|-------------|------------|--------------|--------------|-------------|

2 DIVIDERS, OPEN CENTER SECTION

|                       |                |            |            |           |              |             |
|-----------------------|----------------|------------|------------|-----------|--------------|-------------|
| <b>LEV-TR4372MHSD</b> | <b>\$1,692</b> | <b>115</b> | <b>3.9</b> | <b>71</b> | <b>15.75</b> | <b>42.5</b> |
|-----------------------|----------------|------------|------------|-----------|--------------|-------------|

- 43" HUTCHES ALIGN WITH 72" TALL STORAGE
- HANDLES ON THE LEFT

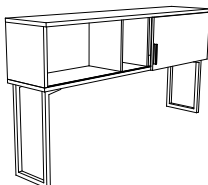

LEV-TR4372MHSD

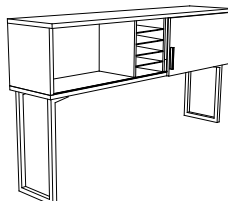

- TO ADD A SET OF 4 PLEXI COLLATOR SHELVES, **ADD '-COL' TO ITEM #** & ADD **\$369** TO RETAIL PRICE 72" HUTCHES ONLY  
**Example:** LEV-TR4372MHSD-COL

**RTA**

| MODEL | LIST | WEIGHT | CUBE            | W  | D  | H  |
|-------|------|--------|-----------------|----|----|----|
|       |      | LBS    | FT <sup>3</sup> | IN | IN | IN |

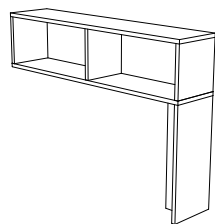

LEV-4460DEH-LAP

**DIVIDER HUTCH - OPEN END HUTCH W/ LAMINATE SUPPORT GABLE**

NON-HANDED ASSEMBLY

|                 |              |      |     |       |    |    |
|-----------------|--------------|------|-----|-------|----|----|
| LEV-4454DEH-LAP | <b>\$706</b> | 73.7 | 2.5 | 53.25 | 13 | 44 |
| LEV-4460DEH-LAP | <b>\$732</b> | 79   | 2.7 | 59.25 | 13 | 44 |
| LEV-4466DEH-LAP | <b>\$759</b> | 84.3 | 2.9 | 65    | 13 | 44 |
| LEV-4472DEH-LAP | <b>\$784</b> | 89.6 | 3.1 | 71    | 13 | 44 |

- SIZED FOR 30" OVERHANG. EXAMPLE: USE 72" SIZE FOR 42" DEEP WORK SURFACES

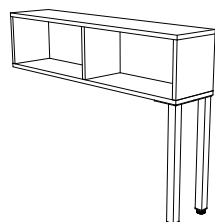

LEV-4460DEH-SQ2

**DIVIDER HUTCH - OPEN END HUTCH W/ SQUARE OFFSET LEGS**

NON-HANDED ASSEMBLY

|                 |              |      |      |       |    |    |
|-----------------|--------------|------|------|-------|----|----|
| LEV-4454DEH-SQ2 | <b>\$706</b> | 68   | 20.7 | 53.25 | 13 | 44 |
| LEV-4460DEH-SQ2 | <b>\$732</b> | 73.2 | 22.9 | 59.25 | 13 | 44 |
| LEV-4466DEH-SQ2 | <b>\$759</b> | 78.5 | 25.1 | 65    | 13 | 44 |
| LEV-4472DEH-SQ2 | <b>\$784</b> | 83.8 | 27.3 | 71    | 13 | 44 |

- SIZED FOR 30" OVERHANG. EXAMPLE: USE 54" SIZE FOR 24" DEEP WORK SURFACES

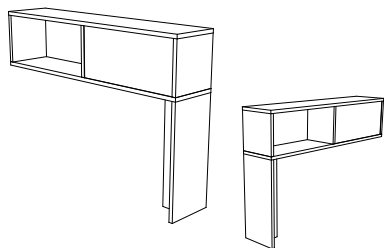

LEV-4460DSH-LAP

**DIVIDER HUTCH - OPEN SHARED HUTCH W/ LAMINATE SUPPORT GABLE**

NON-HANDED ASSEMBLY

|                 |              |      |     |       |    |    |
|-----------------|--------------|------|-----|-------|----|----|
| LEV-4454DSH-LAP | <b>\$706</b> | 73.8 | 2.5 | 53.25 | 13 | 44 |
| LEV-4460DSH-LAP | <b>\$732</b> | 79.1 | 2.7 | 59.25 | 13 | 44 |
| LEV-4466DSH-LAP | <b>\$759</b> | 84.4 | 2.9 | 65    | 13 | 44 |
| LEV-4472DSH-LAP | <b>\$784</b> | 89.6 | 3.1 | 71    | 13 | 44 |

- SIZED FOR 30" OVERHANG. EXAMPLE: USE 72" SIZE FOR 42" DEEP WORK SURFACES

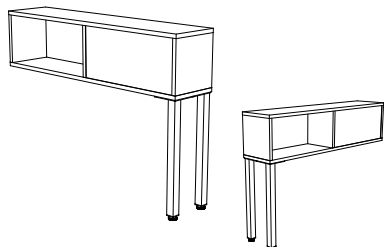

LEV-4460DSH-SQ2

**DIVIDER HUTCH - OPEN SHARED HUTCH W/ SQUARE OFFSET LEGS**

NON-HANDED ASSEMBLY

|                 |              |      |      |       |    |    |
|-----------------|--------------|------|------|-------|----|----|
| LEV-4454DSH-SQ2 | <b>\$706</b> | 68.1 | 20.7 | 53.25 | 13 | 44 |
| LEV-4460DSH-SQ2 | <b>\$732</b> | 73.3 | 22.9 | 59.25 | 13 | 44 |
| LEV-4466DSH-SQ2 | <b>\$759</b> | 78.6 | 25.1 | 65    | 13 | 44 |
| LEV-4472DSH-SQ2 | <b>\$784</b> | 83.9 | 27.3 | 71    | 13 | 44 |

- SIZED FOR 30" OVERHANG. EXAMPLE: USE 54" SIZE FOR 24" DEEP WORK SURFACES

| MODEL | LIST     | *AGD | WEIGHT | CUBE            | W  | D  | H  |
|-------|----------|------|--------|-----------------|----|----|----|
|       | UPCHARGE |      | LBS    | FT <sup>3</sup> | IN | IN | IN |

**EXAMPLES**

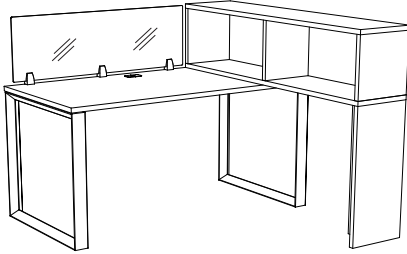

| <b>EXAMPLE 1</b> |  |
|------------------|--|
| LEV-3060TBL-LOOP | TABLE W/ LOOP LEGS                                       |
| LEV-4460DEH-LAP  | DIVIDER HUTCH - OPEN END HUTCH W/ LAMINATE SUPPORT GABLE |
| EM1-1548PLX      | 15" EDGE MOUNT PLEXIGLASS PRIVACY PANE                   |

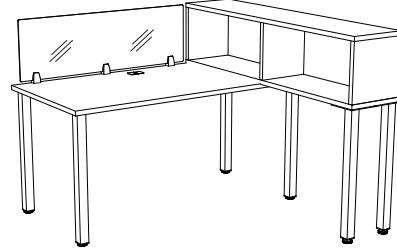

| <b>EXAMPLE 2</b> |  |
|------------------|--|
| LEV-3060TBL-SQ2  | TABLE W/ SQUARE OFFSET LEGS                          |
| LEV-4460DEH-SQ2  | DIVIDER HUTCH - OPEN END HUTCH W/ SQUARE OFFSET LEGS |
| EM1-1548PLX      | 15" EDGE MOUNT PLEXIGLASS PRIVACY PANE               |

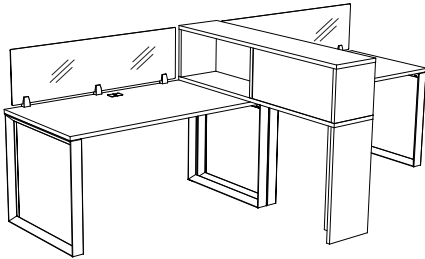

| <b>EXAMPLE 3</b> |   |
|------------------|---|
| LEV-3060TBL-LOOP | X2 TABLE W/ LOOP LEGS                                       |
| LEV-4460DSH-LAP  | DIVIDER HUTCH - OPEN SHARED HUTCH W/ LAMINATE SUPPORT GABLE |
| EM1-1554PLX      | X2 15" EDGE MOUNT PLEXIGLASS PRIVACY PANE                   |

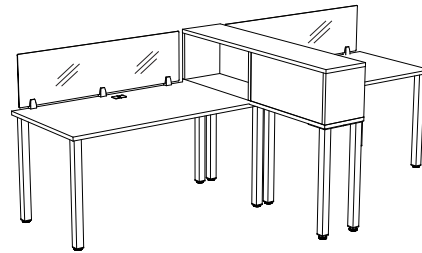

| <b>EXAMPLE 4</b> |   |
|------------------|---|
| LEV-3060TBL-SQ2  | X2 TABLE W/ SQUARE OFFSET LEGS                          |
| LEV-4460DEH-SQ2  | DIVIDER HUTCH - OPEN SHARED HUTCH W/ SQUARE OFFSET LEGS |
| EM1-1554PLX      | X2 15" EDGE MOUNT PLEXIGLASS PRIVACY PANE               |

| MODEL | LIST     | *AGD | WEIGHT | CUBE            | W  | D  | H  |
|-------|----------|------|--------|-----------------|----|----|----|
|       | UPCHARGE |      | LBS    | FT <sup>3</sup> | IN | IN | IN |

**DESKTOP ORGANIZER**

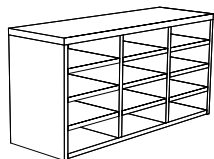

LEV-1836DTO

1 DIVIDER, 6 ADJUSTABLE SHELVES

|                    |              |           |          |              |           |              |
|--------------------|--------------|-----------|----------|--------------|-----------|--------------|
| <b>LEV-1824DTO</b> | <b>\$585</b> | <b>46</b> | <b>2</b> | <b>23.75</b> | <b>12</b> | <b>17.75</b> |
| <b>LEV-1830DTO</b> | <b>\$593</b> | <b>49</b> | <b>2</b> | <b>29.5</b>  | <b>12</b> | <b>17.75</b> |

2 DIVIDERS, 9 ADJUSTABLE SHELVES

|                    |              |           |            |             |           |              |
|--------------------|--------------|-----------|------------|-------------|-----------|--------------|
| <b>LEV-1836DTO</b> | <b>\$603</b> | <b>52</b> | <b>2</b>   | <b>35.5</b> | <b>12</b> | <b>17.75</b> |
| <b>LEV-1842DTO</b> | <b>\$650</b> | <b>56</b> | <b>2.3</b> | <b>41.5</b> | <b>12</b> | <b>17.75</b> |

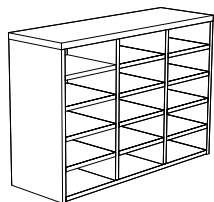

LEV-2536DTO

3 DIVIDERS, 12 ADJUSTABLE SHELVES

|                    |              |           |            |              |           |              |
|--------------------|--------------|-----------|------------|--------------|-----------|--------------|
| <b>LEV-1848DTO</b> | <b>\$664</b> | <b>62</b> | <b>2.7</b> | <b>47.25</b> | <b>12</b> | <b>17.75</b> |
|--------------------|--------------|-----------|------------|--------------|-----------|--------------|

- WILL FIT IN 36" HIGH HUTCH CAVITY FOR LETTER STORAGE
- STAND ALONE UNIT WITH BACK

1 DIVIDER, 8 ADJUSTABLE SHELVES

|                    |              |           |          |              |           |              |
|--------------------|--------------|-----------|----------|--------------|-----------|--------------|
| <b>LEV-2524DTO</b> | <b>\$593</b> | <b>69</b> | <b>2</b> | <b>23.75</b> | <b>12</b> | <b>24.75</b> |
| <b>LEV-2530DTO</b> | <b>\$602</b> | <b>72</b> | <b>2</b> | <b>29.5</b>  | <b>12</b> | <b>24.75</b> |

2 DIVIDERS, 12 ADJUSTABLE SHELVES

|                    |              |           |            |             |           |              |
|--------------------|--------------|-----------|------------|-------------|-----------|--------------|
| <b>LEV-2536DTO</b> | <b>\$620</b> | <b>76</b> | <b>2</b>   | <b>35.5</b> | <b>12</b> | <b>24.75</b> |
| <b>LEV-2542DTO</b> | <b>\$700</b> | <b>82</b> | <b>2.3</b> | <b>41.5</b> | <b>12</b> | <b>24.75</b> |

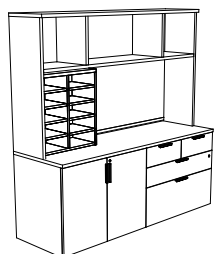

3 DIVIDERS, 16 ADJUSTABLE SHELVES

|                    |              |           |            |              |           |              |
|--------------------|--------------|-----------|------------|--------------|-----------|--------------|
| <b>LEV-2548DTO</b> | <b>\$716</b> | <b>89</b> | <b>2.7</b> | <b>47.25</b> | <b>12</b> | <b>24.75</b> |
|--------------------|--------------|-----------|------------|--------------|-----------|--------------|

- WILL FIT IN 43" HIGH HUTCH CAVITY FOR LETTER STORAGE
- STAND ALONE UNIT WITH BACK

**RTA**

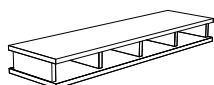

LEV-4204HC

**HORIZONTAL CUBBY-HOLE**

W/ ADJUSTABLE DIVIDERS - GREAT FOR ORGANIZING PAPER, ENVELOPES, ETC.

|                   |              |           |            |              |           |          |
|-------------------|--------------|-----------|------------|--------------|-----------|----------|
| <b>LEV-3004HC</b> | <b>\$303</b> | <b>11</b> | <b>1</b>   | <b>27.5</b>  | <b>11</b> | <b>4</b> |
| <b>LEV-3604HC</b> | <b>\$312</b> | <b>14</b> | <b>1</b>   | <b>33.5</b>  | <b>11</b> | <b>4</b> |
| <b>LEV-4204HC</b> | <b>\$361</b> | <b>17</b> | <b>1</b>   | <b>39.5</b>  | <b>11</b> | <b>4</b> |
| <b>LEV-4804HC</b> | <b>\$368</b> | <b>20</b> | <b>2</b>   | <b>45.75</b> | <b>11</b> | <b>4</b> |
| <b>LEV-5404HC</b> | <b>\$378</b> | <b>23</b> | <b>2</b>   | <b>51.25</b> | <b>11</b> | <b>4</b> |
| <b>LEV-6004HC</b> | <b>\$405</b> | <b>26</b> | <b>2</b>   | <b>57.25</b> | <b>11</b> | <b>4</b> |
| <b>LEV-6604HC</b> | <b>\$435</b> | <b>29</b> | <b>2</b>   | <b>63</b>    | <b>11</b> | <b>4</b> |
| <b>LEV-7204HC</b> | <b>\$463</b> | <b>32</b> | <b>2</b>   | <b>69</b>    | <b>11</b> | <b>4</b> |
| <b>LEV-7804HC</b> | <b>\$479</b> | <b>35</b> | <b>2.5</b> | <b>75</b>    | <b>11</b> | <b>4</b> |
| <b>LEV-8404HC</b> | <b>\$493</b> | <b>38</b> | <b>2.5</b> | <b>80.75</b> | <b>11</b> | <b>4</b> |

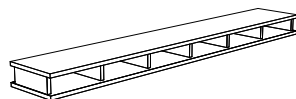

LEV-7204HC

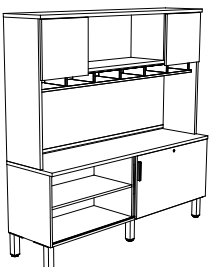

**RTA**



| MODEL | LIST | *AGD     | WEIGHT | CUBE            | W  | D  | H  |
|-------|------|----------|--------|-----------------|----|----|----|
|       |      | UPCHARGE | LBS    | FT <sup>3</sup> | IN | IN | IN |

**OVERHEAD STORAGE - OPEN**

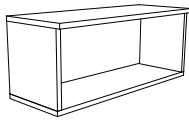

LEV-1742OS

WALL HUNG

|            |       |     |      |   |       |       |       |
|------------|-------|-----|------|---|-------|-------|-------|
| LEV-1730OS | \$501 | N/A | 44.1 | 2 | 29.5  | 15.75 | 16.75 |
| LEV-1736OS | \$544 | N/A | 50.9 | 2 | 35.5  | 15.75 | 16.75 |
| LEV-1742OS | \$591 | N/A | 57.6 | 2 | 41.5  | 15.75 | 16.75 |
| LEV-1748OS | \$656 | N/A | 89.6 | 2 | 47.25 | 15.75 | 16.75 |

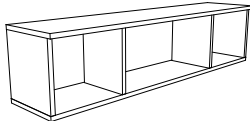

LEV-1772OS

WALL HUNG W/ 2 DIVIDERS

|            |       |     |       |   |       |       |       |
|------------|-------|-----|-------|---|-------|-------|-------|
| LEV-1754OS | \$673 | N/A | 81.2  | 3 | 53.25 | 15.75 | 16.75 |
| LEV-1760OS | \$722 | N/A | 87.9  | 3 | 59.25 | 15.75 | 16.75 |
| LEV-1766OS | \$770 | N/A | 94.7  | 4 | 65    | 15.75 | 16.75 |
| LEV-1772OS | \$888 | N/A | 101.5 | 4 | 71    | 15.75 | 16.75 |

**OVERHEAD STORAGE - W/ 2 DOORS**

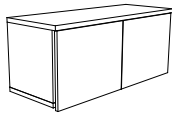

LEV-1742OSHD2  
LEV-1742OSHD2-AGD

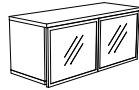

LEV-1772OSHD2  
LEV-1772OSHD2-AGD

WALL HUNG

|               |       |       |      |     |       |       |       |
|---------------|-------|-------|------|-----|-------|-------|-------|
| LEV-1730OSHD2 | \$742 | \$420 | 52.6 | 2.5 | 29.5  | 15.75 | 16.75 |
| LEV-1736OSHD2 | \$782 | \$466 | 61.2 | 2.5 | 35.5  | 15.75 | 16.75 |
| LEV-1742OSHD2 | \$837 | \$513 | 69.7 | 2.5 | 41.5  | 15.75 | 16.75 |
| LEV-1748OSHD2 | \$896 | \$532 | 78.3 | 2.5 | 47.25 | 15.75 | 16.75 |

WALL HUNG W/ 2 DIVIDERS

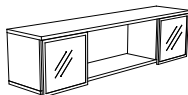
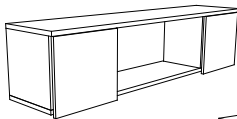

|               |         |       |       |     |       |       |       |
|---------------|---------|-------|-------|-----|-------|-------|-------|
| LEV-1754OSHD2 | \$1,067 | \$420 | 89    | 3.8 | 53.25 | 15.75 | 16.75 |
| LEV-1760OSHD2 | \$1,145 | \$466 | 96.6  | 3.8 | 59.25 | 15.75 | 16.75 |
| LEV-1766OSHD2 | \$1,171 | \$513 | 104.3 | 5   | 65    | 15.75 | 16.75 |
| LEV-1772OSHD2 | \$1,290 | \$532 | 111.9 | 5   | 71    | 15.75 | 16.75 |

- DOORS SHIP IN A SECOND CARTON

**OVERHEAD STORAGE - W/ 4 DOORS**

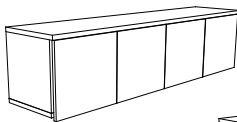

LEV-1772OSHD4  
LEV-1772OSHD4-AGD

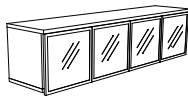

WALL HUNG W/ 2 DIVIDERS

|               |         |       |       |     |       |       |       |
|---------------|---------|-------|-------|-----|-------|-------|-------|
| LEV-1754OSHD4 | \$1,115 | \$814 | 96.8  | 3.8 | 53.25 | 15.75 | 16.75 |
| LEV-1760OSHD4 | \$1,194 | \$834 | 105.3 | 3.8 | 59.25 | 15.75 | 16.75 |
| LEV-1766OSHD4 | \$1,219 | \$886 | 113.8 | 5   | 65    | 15.75 | 16.75 |
| LEV-1772OSHD4 | \$1,338 | \$893 | 122.4 | 5   | 71    | 15.75 | 16.75 |

- DOORS SHIP IN A SECOND CARTON

RTA

# LEVELS SERIES OVERHEAD STORAGE

| MODEL | LIST     | *AGD | WEIGHT | CUBE            | W  | D  | H  |
|-------|----------|------|--------|-----------------|----|----|----|
|       | UPCHARGE |      | LBS    | FT <sup>3</sup> | IN | IN | IN |

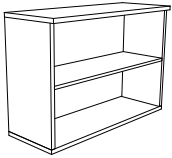

LEV-2942OS

### DOUBLE HIGH OVERHEAD STORAGE - OPEN

WALL HUNG W/ 1 ADJUSTABLE SHELF

|            |                |     |      |   |       |       |       |
|------------|----------------|-----|------|---|-------|-------|-------|
| LEV-2930OS | <b>\$803</b>   | N/A | 65.7 | 3 | 29.5  | 15.75 | 28.75 |
| LEV-2936OS | <b>\$871</b>   | N/A | 75.2 | 3 | 35.5  | 15.75 | 28.75 |
| LEV-2942OS | <b>\$946</b>   | N/A | 84.7 | 3 | 41.5  | 15.75 | 28.75 |
| LEV-2948OS | <b>\$1,047</b> | N/A | 94.2 | 3 | 47.25 | 15.75 | 28.75 |

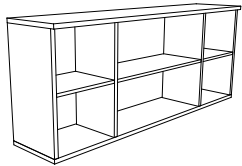

LEV-1772OS

WALL HUNG W/ 2 DIVIDERS 3 ADJUSTABLE SHELVES

|            |                |     |       |     |       |       |       |
|------------|----------------|-----|-------|-----|-------|-------|-------|
| LEV-2954OS | <b>\$1,075</b> | N/A | 121.2 | 4.5 | 53.25 | 15.75 | 28.75 |
| LEV-2960OS | <b>\$1,156</b> | N/A | 130.7 | 6   | 65    | 15.75 | 28.75 |
| LEV-2966OS | <b>\$1,231</b> | N/A | 135   | 6   | 65    | 15.75 | 29.5  |
| LEV-2972OS | <b>\$1,419</b> | N/A | 149.7 | 6   | 71    | 15.75 | 28.75 |

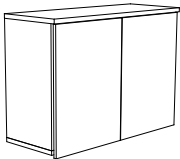

LEV-2942OSHD2  
LEV-2942OSHD2-AGD

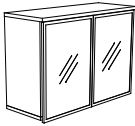

### DOUBLE HIGH OVERHEAD STORAGE - W/ 2 DOORS

WALL HUNG W/ 1 ADJUSTABLE SHELF

|               |                |       |       |     |       |       |       |
|---------------|----------------|-------|-------|-----|-------|-------|-------|
| LEV-2930OSHD2 | <b>\$1,163</b> | \$623 | 80.4  | 3.5 | 29.5  | 15.75 | 28.75 |
| LEV-2936OSHD2 | <b>\$1,230</b> | \$710 | 93    | 3.5 | 35.5  | 15.75 | 28.75 |
| LEV-2942OSHD2 | <b>\$1,304</b> | \$776 | 105.5 | 3.5 | 41.5  | 15.75 | 28.75 |
| LEV-2948OSHD2 | <b>\$1,405</b> | \$840 | 118.1 | 3.6 | 47.25 | 15.75 | 28.75 |

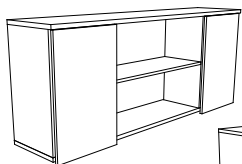

LEV-2972OSHD2  
LEV-2972OSHD2-AGD

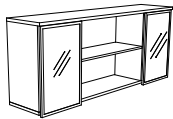

WALL HUNG W/ 2 DIVIDERS 3 ADJUSTABLE SHELF

|               |                |       |       |     |       |       |       |
|---------------|----------------|-------|-------|-----|-------|-------|-------|
| LEV-2954OSHD2 | <b>\$1,712</b> | \$623 | 134.6 | 5.2 | 53.25 | 15.75 | 28.75 |
| LEV-2960OSHD2 | <b>\$1,742</b> | \$710 | 145.6 | 5.3 | 59.25 | 15.75 | 28.75 |
| LEV-2966OSHD2 | <b>\$1,817</b> | \$776 | 156.7 | 6.8 | 65    | 15.75 | 28.75 |
| LEV-2972OSHD2 | <b>\$2,007</b> | \$840 | 167.7 | 6.9 | 71    | 15.75 | 28.75 |

- DOORS SHIP IN A SECOND CARTON

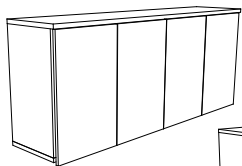

LEV-1772OSHD4  
LEV-1772OSHD4-AGD

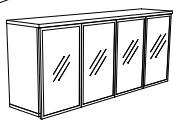

### DOUBLE HIGH OVERHEAD STORAGE - W/ 4 DOORS

WALL HUNG W/ 2 DIVIDERS 3 ADJUSTABLE SHELF

|               |                |         |       |     |       |       |       |
|---------------|----------------|---------|-------|-----|-------|-------|-------|
| LEV-2954OSHD4 | <b>\$1,759</b> | \$1,143 | 148   | 5.2 | 53.25 | 15.75 | 28.75 |
| LEV-2960OSHD4 | <b>\$1,790</b> | \$1,208 | 160.6 | 5.3 | 59.25 | 15.75 | 28.75 |
| LEV-2966OSHD4 | <b>\$1,863</b> | \$1,301 | 173.1 | 6.8 | 65    | 15.75 | 28.75 |
| LEV-2972OSHD4 | <b>\$2,053</b> | \$1,307 | 185.7 | 6.9 | 71    | 15.75 | 28.75 |

- DOORS SHIP IN A SECOND CARTON

RTA

**OVERHEAD STORAGE WITH PLEXI BI-PASS DOORS**

| MODEL | LIST | WEIGHT | CUBE            | W  | D  | H  |
|-------|------|--------|-----------------|----|----|----|
|       |      | LBS    | FT <sup>3</sup> | IN | IN | IN |

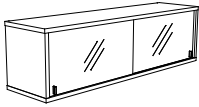

LEV-1760OSBD

**OVERHEAD STORAGE W/ PLEXI BI-PASS DOORS**

WALL HUNG W/ 1 DIVIDERS

|                     |                |              |            |              |              |              |
|---------------------|----------------|--------------|------------|--------------|--------------|--------------|
| <b>LEV-1760OSBD</b> | <b>\$1,534</b> | <b>105.3</b> | <b>3.8</b> | <b>59.25</b> | <b>15.75</b> | <b>16.75</b> |
|---------------------|----------------|--------------|------------|--------------|--------------|--------------|

WALL HUNG W/ 2 DIVIDERS

|                     |                |              |          |           |              |              |
|---------------------|----------------|--------------|----------|-----------|--------------|--------------|
| <b>LEV-1772OSBD</b> | <b>\$1,671</b> | <b>122.4</b> | <b>5</b> | <b>71</b> | <b>15.75</b> | <b>16.75</b> |
|---------------------|----------------|--------------|----------|-----------|--------------|--------------|

- DOORS HAVE HANDLES

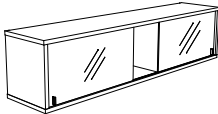

LEV-1772OSBD

**OVERHEAD STORAGE WITH SLIDING DOOR**

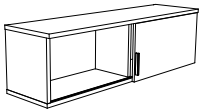

LEV-1760OSSD

**OVERHEAD STORAGE W/ SLIDING DOOR**

WALL HUNG W/ 1 DIVIDERS

|                     |                |              |            |              |              |              |
|---------------------|----------------|--------------|------------|--------------|--------------|--------------|
| <b>LEV-1760OSSD</b> | <b>\$1,065</b> | <b>105.3</b> | <b>3.8</b> | <b>59.25</b> | <b>15.75</b> | <b>16.75</b> |
|---------------------|----------------|--------------|------------|--------------|--------------|--------------|

WALL HUNG W/ 2 DIVIDERS

|                     |                |              |          |           |              |              |
|---------------------|----------------|--------------|----------|-----------|--------------|--------------|
| <b>LEV-1772OSSD</b> | <b>\$1,202</b> | <b>122.4</b> | <b>5</b> | <b>71</b> | <b>15.75</b> | <b>16.75</b> |
|---------------------|----------------|--------------|----------|-----------|--------------|--------------|

- HANDLE ON THE LEFT

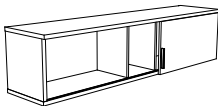

LEV-1772OSSD

# LEVELS SERIES

## SQUARE CORNER SHELVES

| MODEL | LIST | WEIGHT | CUBE            | W  | D  | H  |
|-------|------|--------|-----------------|----|----|----|
|       |      | LBS    | FT <sup>3</sup> | IN | IN | IN |

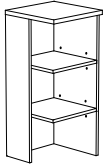

LEV-3616HSCSL

### SQUARE HUTCH CORNER SHELVES

FOR LEFT SIDE APPLICATIONS

MATCHES 36" HUTCH OR 65" CABINET HEIGHTS. 2 ADJUSTABLE SHELVES.

|                      |              |           |            |              |              |             |
|----------------------|--------------|-----------|------------|--------------|--------------|-------------|
| <b>LEV-3616HSCSL</b> | <b>\$487</b> | <b>65</b> | <b>1.2</b> | <b>15.75</b> | <b>15.75</b> | <b>35.5</b> |
|----------------------|--------------|-----------|------------|--------------|--------------|-------------|

MATCHES 43" HUTCH OR 72" CABINET HEIGHTS. 2 ADJUSTABLE SHELVES.

|                      |              |           |            |              |              |             |
|----------------------|--------------|-----------|------------|--------------|--------------|-------------|
| <b>LEV-4316HSCSL</b> | <b>\$534</b> | <b>72</b> | <b>1.8</b> | <b>15.75</b> | <b>15.75</b> | <b>42.5</b> |
|----------------------|--------------|-----------|------------|--------------|--------------|-------------|

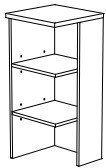

LEV-3616HSCSR

FOR RIGHT SIDE APPLICATIONS

MATCHES 36" HUTCH OR 65" CABINET HEIGHTS. 2 ADJUSTABLE SHELVES.

|                      |              |           |            |              |              |             |
|----------------------|--------------|-----------|------------|--------------|--------------|-------------|
| <b>LEV-3616HSCSR</b> | <b>\$487</b> | <b>65</b> | <b>1.2</b> | <b>15.75</b> | <b>15.75</b> | <b>35.5</b> |
|----------------------|--------------|-----------|------------|--------------|--------------|-------------|

MATCHES 43" HUTCH OR 72" CABINET HEIGHTS. 2 ADJUSTABLE SHELVES.

|                      |              |           |            |              |              |             |
|----------------------|--------------|-----------|------------|--------------|--------------|-------------|
| <b>LEV-4316HSCSR</b> | <b>\$534</b> | <b>72</b> | <b>1.8</b> | <b>15.75</b> | <b>15.75</b> | <b>42.5</b> |
|----------------------|--------------|-----------|------------|--------------|--------------|-------------|

RTA

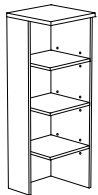

LEV-4816HSCSL

### SQUARE DOUBLE HIGH HUTCH CORNER SHELVES

FOR LEFT SIDE APPLICATIONS

MATCHES 48" HUTCH OR 77" CABINET HEIGHTS. 3 ADJUSTABLE SHELVES.

|                      |              |           |          |              |              |              |
|----------------------|--------------|-----------|----------|--------------|--------------|--------------|
| <b>LEV-4816HSCSL</b> | <b>\$600</b> | <b>82</b> | <b>2</b> | <b>15.75</b> | <b>15.75</b> | <b>47.25</b> |
|----------------------|--------------|-----------|----------|--------------|--------------|--------------|

MATCHES 55" HUTCH OR 84" CABINET HEIGHTS. 3 ADJUSTABLE SHELVES.

|                      |              |           |            |              |              |              |
|----------------------|--------------|-----------|------------|--------------|--------------|--------------|
| <b>LEV-5516HSCSL</b> | <b>\$731</b> | <b>98</b> | <b>2.7</b> | <b>15.75</b> | <b>15.75</b> | <b>54.25</b> |
|----------------------|--------------|-----------|------------|--------------|--------------|--------------|

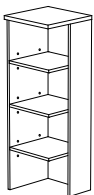

LEV-4816HSCSR

FOR RIGHT SIDE APPLICATIONS

MATCHES 48" HUTCH OR 77" CABINET HEIGHTS. 3 ADJUSTABLE SHELVES.

|                      |              |           |          |              |              |              |
|----------------------|--------------|-----------|----------|--------------|--------------|--------------|
| <b>LEV-4816HSCSR</b> | <b>\$600</b> | <b>82</b> | <b>2</b> | <b>15.75</b> | <b>15.75</b> | <b>47.25</b> |
|----------------------|--------------|-----------|----------|--------------|--------------|--------------|

MATCHES 55" HUTCH OR 84" CABINET HEIGHTS. 3 ADJUSTABLE SHELVES.

|                      |              |           |            |              |              |              |
|----------------------|--------------|-----------|------------|--------------|--------------|--------------|
| <b>LEV-5516HSCSR</b> | <b>\$731</b> | <b>98</b> | <b>2.7</b> | <b>15.75</b> | <b>15.75</b> | <b>54.25</b> |
|----------------------|--------------|-----------|------------|--------------|--------------|--------------|

RTA

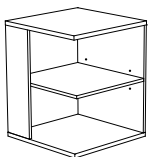

LEV-2924SCSL

### SQUARE CORNER SHELVES

FOR LEFT SIDE APPLICATIONS

1 ADJUSTABLE SHELF

|                     |              |           |          |              |              |           |
|---------------------|--------------|-----------|----------|--------------|--------------|-----------|
| <b>LEV-2920SCSL</b> | <b>\$525</b> | <b>51</b> | <b>3</b> | <b>19.75</b> | <b>19.75</b> | <b>29</b> |
|---------------------|--------------|-----------|----------|--------------|--------------|-----------|

|                     |              |           |            |              |              |           |
|---------------------|--------------|-----------|------------|--------------|--------------|-----------|
| <b>LEV-2924SCSL</b> | <b>\$585</b> | <b>65</b> | <b>3.2</b> | <b>23.75</b> | <b>23.75</b> | <b>29</b> |
|---------------------|--------------|-----------|------------|--------------|--------------|-----------|

|                     |              |           |            |             |             |           |
|---------------------|--------------|-----------|------------|-------------|-------------|-----------|
| <b>LEV-2930SCSL</b> | <b>\$615</b> | <b>51</b> | <b>3.3</b> | <b>29.5</b> | <b>29.5</b> | <b>29</b> |
|---------------------|--------------|-----------|------------|-------------|-------------|-----------|

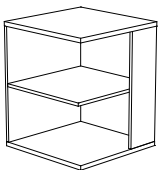

LEV-2924SCSR

FOR RIGHT SIDE APPLICATIONS

1 ADJUSTABLE SHELF

|                     |              |           |          |              |              |           |
|---------------------|--------------|-----------|----------|--------------|--------------|-----------|
| <b>LEV-2920SCSR</b> | <b>\$525</b> | <b>65</b> | <b>3</b> | <b>19.75</b> | <b>19.75</b> | <b>29</b> |
|---------------------|--------------|-----------|----------|--------------|--------------|-----------|

|                     |              |           |            |              |              |           |
|---------------------|--------------|-----------|------------|--------------|--------------|-----------|
| <b>LEV-2924SCSR</b> | <b>\$585</b> | <b>54</b> | <b>3.2</b> | <b>23.75</b> | <b>23.75</b> | <b>29</b> |
|---------------------|--------------|-----------|------------|--------------|--------------|-----------|

|                     |              |           |            |             |             |           |
|---------------------|--------------|-----------|------------|-------------|-------------|-----------|
| <b>LEV-2930SCSR</b> | <b>\$615</b> | <b>68</b> | <b>3.3</b> | <b>29.5</b> | <b>29.5</b> | <b>29</b> |
|---------------------|--------------|-----------|------------|-------------|-------------|-----------|

RTA

**SQUARE CORNER SHELVES**

| MODEL | LIST | WEIGHT | CUBE            | W  | D  | H  |
|-------|------|--------|-----------------|----|----|----|
|       |      | LBS    | FT <sup>3</sup> | IN | IN | IN |

**SQUARE FREEST&ING CORNER SHELVES**

FOR LEFT SIDE APPLICATIONS

3 ADJUSTABLE SHELVES

|                     |              |           |            |              |              |             |
|---------------------|--------------|-----------|------------|--------------|--------------|-------------|
| <b>LEV-5820SCSL</b> | <b>\$864</b> | <b>93</b> | <b>4.5</b> | <b>19.75</b> | <b>19.75</b> | <b>57.5</b> |
|---------------------|--------------|-----------|------------|--------------|--------------|-------------|

4 ADJUSTABLE SHELVES

|                     |                |            |             |              |              |             |
|---------------------|----------------|------------|-------------|--------------|--------------|-------------|
| <b>LEV-6520SCSL</b> | <b>\$871</b>   | <b>154</b> | <b>5</b>    | <b>19.5</b>  | <b>19.5</b>  | <b>64.5</b> |
| <b>LEV-6524SCSL</b> | <b>\$1,012</b> | <b>170</b> | <b>6</b>    | <b>23.75</b> | <b>23.75</b> | <b>64.5</b> |
| <b>LEV-7220SCSL</b> | <b>\$1,024</b> | <b>163</b> | <b>6.10</b> | <b>19.5</b>  | <b>19.5</b>  | <b>71.5</b> |
| <b>LEV-7224SCSL</b> | <b>\$1,100</b> | <b>180</b> | <b>6.5</b>  | <b>23.75</b> | <b>23.75</b> | <b>71.5</b> |

5 ADJUSTABLE SHELVES

|                     |                |            |             |              |              |              |
|---------------------|----------------|------------|-------------|--------------|--------------|--------------|
| <b>LEV-7720SCSL</b> | <b>\$1,055</b> | <b>177</b> | <b>6.10</b> | <b>19.75</b> | <b>19.75</b> | <b>76.25</b> |
| <b>LEV-7724SCSL</b> | <b>\$1,152</b> | <b>191</b> | <b>6.9</b>  | <b>23.75</b> | <b>23.75</b> | <b>76.25</b> |
| <b>LEV-8420SCSL</b> | <b>\$1,193</b> | <b>192</b> | <b>7.5</b>  | <b>19.75</b> | <b>19.75</b> | <b>83.25</b> |
| <b>LEV-8424SCSL</b> | <b>\$1,290</b> | <b>204</b> | <b>8</b>    | <b>23.75</b> | <b>23.75</b> | <b>83.25</b> |

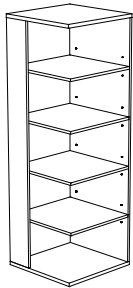

LEV-7224SCSL

**RTA**

FOR RIGHT SIDE APPLICATIONS

3 ADJUSTABLE SHELVES

|                     |              |           |            |              |              |             |
|---------------------|--------------|-----------|------------|--------------|--------------|-------------|
| <b>LEV-5820SCSR</b> | <b>\$864</b> | <b>93</b> | <b>4.5</b> | <b>19.75</b> | <b>19.75</b> | <b>57.5</b> |
|---------------------|--------------|-----------|------------|--------------|--------------|-------------|

4 ADJUSTABLE SHELVES

|                     |                |            |             |              |              |             |
|---------------------|----------------|------------|-------------|--------------|--------------|-------------|
| <b>LEV-6520SCSR</b> | <b>\$871</b>   | <b>154</b> | <b>5</b>    | <b>19.5</b>  | <b>19.5</b>  | <b>64.5</b> |
| <b>LEV-6524SCSR</b> | <b>\$1,012</b> | <b>170</b> | <b>6</b>    | <b>23.75</b> | <b>23.75</b> | <b>64.5</b> |
| <b>LEV-7220SCSR</b> | <b>\$1,024</b> | <b>163</b> | <b>6.10</b> | <b>19.5</b>  | <b>19.5</b>  | <b>71.5</b> |
| <b>LEV-7224SCSR</b> | <b>\$1,100</b> | <b>180</b> | <b>6.5</b>  | <b>23.75</b> | <b>23.75</b> | <b>71.5</b> |

5 ADJUSTABLE SHELVES

|                     |                |            |             |              |              |              |
|---------------------|----------------|------------|-------------|--------------|--------------|--------------|
| <b>LEV-7720SCSR</b> | <b>\$1,055</b> | <b>177</b> | <b>6.10</b> | <b>19.75</b> | <b>19.75</b> | <b>76.25</b> |
| <b>LEV-7724SCSR</b> | <b>\$1,152</b> | <b>191</b> | <b>6.9</b>  | <b>23.75</b> | <b>23.75</b> | <b>76.25</b> |
| <b>LEV-8420SCSR</b> | <b>\$1,193</b> | <b>192</b> | <b>7.5</b>  | <b>19.75</b> | <b>19.75</b> | <b>83.25</b> |
| <b>LEV-8424SCSR</b> | <b>\$1,290</b> | <b>204</b> | <b>8</b>    | <b>23.75</b> | <b>23.75</b> | <b>83.25</b> |

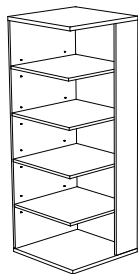

LEV-7224SCSR

**RTA**

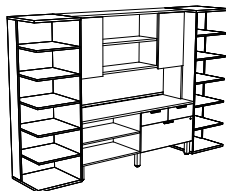

| EXAMPLE 1           |   |
|---------------------|---|
| LEV-7724SCSL        | SQUARE FREEST&ING CORNER SHELVES                          |
| LEV-7724SCSR        | SQUARE FREEST&ING CORNER SHELVES                          |
| LEV-4872HHD2        | 48" DOUBLE HIGH HUTCH W/ 2 DOORS                          |
| LEV-CO2472BBLF-SR29 | OPEN SHELF/BOX/BOX/LATERAL FILE CREDENZA W/ STORAGE RISER |

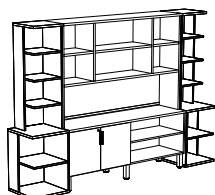

| EXAMPLE 2        |  |
|------------------|--|
| LEV-4816HSCSL    | SQUARE DOUBLE HIGH HUTCH CORNER SHELVES      |
| LEV-4816HSCSR    | SQUARE DOUBLE HIGH HUTCH CORNER SHELVES      |
| LEV-4872H        | DOUBLE HIGH OPEN HUTCH - 48" HIGH            |
| LEV-2920SCSL     | SQUARE CORNER SHELVES                        |
| LEV-2920SCSR     | SQUARE CORNER SHELVES                        |
| LEV-C2072CO-SR29 | CABINET CREDENZA/OPEN SHELF W/ STORAGE RISER |

**LEVELS SERIES  
STORAGE BENCH**

| MODEL | LIST | WEIGHT | CUBE            | W  | D  | H  |
|-------|------|--------|-----------------|----|----|----|
|       |      | LBS    | FT <sup>3</sup> | IN | IN | IN |

**FLIP TOP STORAGE BENCH**

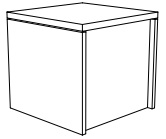

LEV-1818BFT

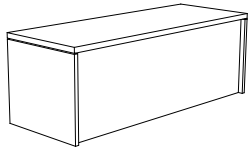

LEV-1848BFT

18" X 18" BENCH W/ FLIP UP LID

**LEV-1818BFT**      **\$746**      32.2      0.9      17.75      17.75      17.25

18" X 24" BENCH W/ FLIP UP LID

**LEV-1824BFT**      **\$780**      44.6      1.19      23.75      17.75      17.25

18" X 36" BENCH W/ FLIP UP LID

**LEV-1836BFT**      **\$837**      61.9      1.33      35.5      17.75      17.25

18" X 48" BENCH W/ FLIP UP LID

**LEV-1848BFT**      **\$922**      79.1      1.77      47.25      17.75      17.25

24" X 24" BENCH W/ FLIP UP LID

**LEV-2424BFT**      **\$806**      68.8      1.58      23.75      23.75      17.25

- SHIPS FULLY ASSEMBLED
  - TO LOCK BENCHES, ADD AN "-L" TO SKU AND AN UPCHARGE OF **\$76**
- EXAMPLE** - LEV-1836BFT-L

**BENCH CUSHIONS**

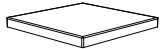

LEV-1818BFT

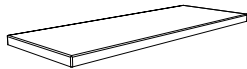

LEV-1848BFT

18" X 18" BENCH CUSHION

**LEV-1818BFT-CUSH**      **\$393**      8.2      0.33      17.75      17.75      1.75

18" X 24" BENCH CUSHION

**LEV-1824BFT-CUSH**      **\$411**      10.9      0.44      23.75      17.75      1.75

18" X 36" BENCH CUSHION

**LEV-1836BFT-CUSH**      **\$467**      16.4      0.66      35.5      17.75      1.75

18" X 48" BENCH CUSHION

**LEV-1848BFT-CUSH**      **\$533**      21.8      0.87      47.25      17.75      1.75

24" X 24" BENCH CUSHION

**LEV-2424BFT-CUSH**      **\$424**      14.5      0.59      23.75      23.75      1.75

**AVAILABLE FINISH:**      ALL AVAILABLE HEARTWOOD CUSHION FABRICS

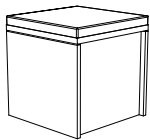

| <b>EXAMPLE 1</b>        |                                |
|-------------------------|--------------------------------|
| <b>LEV-1818BFT</b>      | 18" X 18" BENCH W/ FLIP UP LID |
| <b>LEV-1818BFT-CUSH</b> | 18" X 18" BENCH CUSHION        |

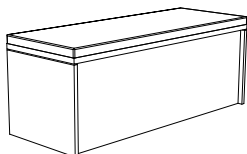

| <b>EXAMPLE 2</b>        |                                |
|-------------------------|--------------------------------|
| <b>LEV-1848BFT</b>      | 18" X 48" BENCH W/ FLIP UP LID |
| <b>LEV-1848BFT-CUSH</b> | 18" X 48" BENCH CUSHION        |

**RTA**

| MODEL | LIST | WEIGHT | CUBE            | W  | D  | H  |
|-------|------|--------|-----------------|----|----|----|
|       |      | LBS    | FT <sup>3</sup> | IN | IN | IN |

**SHARED COMMUNITY TABLES**

- 1" TOPS & 1" GABLES
- CENTERED MODESTY PANEL, HALF HEIGHT IS DEFAULT
- 3/4 MODESTY AVAILABLE
- NO GROMMET

**24" SHARED COMMUNITY TABLES**

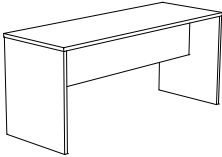

LEV-2466SCT

|             |         |       |     |       |       |    |
|-------------|---------|-------|-----|-------|-------|----|
| LEV-2448SCT | \$693   | 75.1  | 2.9 | 47.25 | 23.75 | 29 |
| LEV-2454SCT | \$724   | 80.3  | 3.2 | 53.25 | 23.75 | 29 |
| LEV-2460SCT | \$740   | 85.5  | 2.7 | 59.25 | 23.75 | 29 |
| LEV-2466SCT | \$780   | 90.7  | 2.9 | 65    | 23.75 | 29 |
| LEV-2472SCT | \$831   | 96    | 3.2 | 71    | 23.75 | 29 |
| LEV-2478SCT | \$946   | 101.2 | 3.4 | 77    | 23.75 | 29 |
| LEV-2484SCT | \$1,057 | 106.4 | 3.7 | 82.75 | 23.75 | 29 |
| LEV-2490SCT | \$1,146 | 111.6 | 3.9 | 88.75 | 23.75 | 29 |
| LEV-2496SCT | \$1,249 | 116.8 | 4.2 | 94.5  | 23.75 | 29 |

**30" SHARED COMMUNITY TABLES**

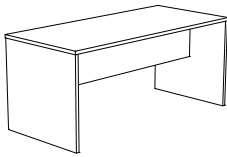

LEV-3066SCT

|             |         |       |     |       |       |    |
|-------------|---------|-------|-----|-------|-------|----|
| LEV-3048SCT | \$755   | 90.9  | 3.5 | 47.25 | 29.75 | 29 |
| LEV-3054SCT | \$785   | 97    | 3.9 | 53.25 | 29.75 | 29 |
| LEV-3060SCT | \$801   | 103.1 | 3.3 | 59.25 | 29.75 | 29 |
| LEV-3066SCT | \$842   | 109.2 | 3.6 | 65    | 29.75 | 29 |
| LEV-3072SCT | \$893   | 115.4 | 3.9 | 71    | 29.75 | 29 |
| LEV-3078SCT | \$1,009 | 121.5 | 4.2 | 77    | 29.75 | 29 |
| LEV-3084SCT | \$1,118 | 127.6 | 4.6 | 82.75 | 29.75 | 29 |
| LEV-3090SCT | \$1,248 | 133.7 | 4.9 | 88.75 | 29.75 | 29 |
| LEV-3096SCT | \$1,338 | 139.8 | 5.2 | 94.5  | 29.75 | 29 |

**36" SHARED COMMUNITY TABLES**

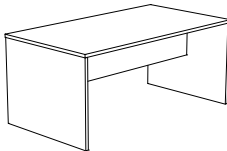

LEV-3666SCT

|             |         |       |      |       |      |    |
|-------------|---------|-------|------|-------|------|----|
| LEV-3648SCT | \$831   | 106.6 | 4.2  | 47.25 | 35.5 | 29 |
| LEV-3654SCT | \$873   | 113.6 | 4.7  | 53.25 | 35.5 | 29 |
| LEV-3660SCT | \$889   | 120.6 | 3.9  | 59.25 | 35.5 | 29 |
| LEV-3666SCT | \$931   | 127.7 | 4.3  | 65    | 35.5 | 29 |
| LEV-3672SCT | \$1,131 | 134.7 | 4.6  | 71    | 35.5 | 29 |
| LEV-3678SCT | \$1,168 | 141.7 | 5.03 | 77    | 35.5 | 29 |
| LEV-3684SCT | \$1,338 | 148.8 | 5.4  | 82.75 | 35.5 | 29 |
| LEV-3690SCT | \$1,380 | 155.8 | 5.8  | 88.75 | 35.5 | 29 |
| LEV-3696SCT | \$1,463 | 162.8 | 6.2  | 94.5  | 35.5 | 29 |

RTA

**LEVELS SERIES**  
**SHARED COMMUNITY TABLES**

| MODEL | LIST | WEIGHT | CUBE            | W  | D  | H  |
|-------|------|--------|-----------------|----|----|----|
|       |      | LBS    | FT <sup>3</sup> | IN | IN | IN |

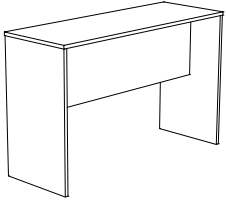

LEV-2466SCT-42

**SHARED COMMUNITY TABLES - 42" HIGH**  
**24" SHARED COMMUNITY TABLES**

|                |         |       |      |       |       |    |
|----------------|---------|-------|------|-------|-------|----|
| LEV-2448SCT-42 | \$832   | 96.5  | 2.87 | 47.25 | 23.75 | 42 |
| LEV-2454SCT-42 | \$869   | 101.7 | 3.21 | 53.25 | 23.75 | 42 |
| LEV-2460SCT-42 | \$886   | 106.9 | 2.67 | 59.25 | 23.75 | 42 |
| LEV-2466SCT-42 | \$937   | 112.1 | 2.93 | 65    | 23.75 | 42 |
| LEV-2472SCT-42 | \$996   | 117.4 | 3.18 | 71    | 23.75 | 42 |
| LEV-2478SCT-42 | \$1,135 | 122.6 | 3.4  | 77    | 23.75 | 42 |
| LEV-2484SCT-42 | \$1,269 | 127.8 | 3.7  | 82.75 | 23.75 | 42 |
| LEV-2490SCT-42 | \$1,376 | 133   | 3.96 | 88.75 | 23.75 | 42 |
| LEV-2496SCT-42 | \$1,498 | 138.2 | 4.22 | 94.5  | 23.75 | 42 |

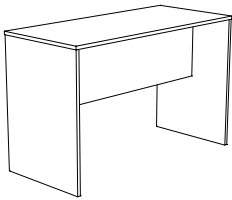

LEV-3066SCT-42

**30" SHARED COMMUNITY TABLES**

|                |         |       |      |       |       |    |
|----------------|---------|-------|------|-------|-------|----|
| LEV-3048SCT-42 | \$906   | 116.2 | 3.53 | 47.25 | 29.75 | 42 |
| LEV-3054SCT-42 | \$943   | 122.3 | 3.96 | 53.25 | 29.75 | 42 |
| LEV-3060SCT-42 | \$961   | 128.4 | 3.28 | 59.25 | 29.75 | 42 |
| LEV-3066SCT-42 | \$1,011 | 134.5 | 3.6  | 65    | 29.75 | 42 |
| LEV-3072SCT-42 | \$1,073 | 140.7 | 3.92 | 71    | 29.75 | 42 |
| LEV-3078SCT-42 | \$1,212 | 146.8 | 4.24 | 77    | 29.75 | 42 |
| LEV-3084SCT-42 | \$1,342 | 152.9 | 4.56 | 82.75 | 29.75 | 42 |
| LEV-3090SCT-42 | \$1,496 | 159   | 4.87 | 88.75 | 29.75 | 42 |
| LEV-3096SCT-42 | \$1,606 | 165.2 | 5.19 | 94.5  | 29.75 | 42 |

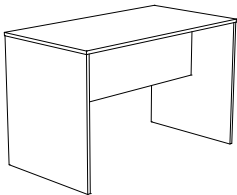

LEV-3666SCT-42

**36" SHARED COMMUNITY TABLES**

|                |         |       |      |       |      |    |
|----------------|---------|-------|------|-------|------|----|
| LEV-3648SCT-42 | \$996   | 135.9 | 4.19 | 47.25 | 35.5 | 42 |
| LEV-3654SCT-42 | \$1,049 | 142.9 | 4.7  | 53.25 | 35.5 | 42 |
| LEV-3660SCT-42 | \$1,065 | 149.9 | 3.9  | 59.25 | 35.5 | 42 |
| LEV-3666SCT-42 | \$1,116 | 156.9 | 4.28 | 65    | 35.5 | 42 |
| LEV-3672SCT-42 | \$1,357 | 164   | 4.65 | 71    | 35.5 | 42 |
| LEV-3678SCT-42 | \$1,401 | 171   | 5.03 | 77    | 35.5 | 42 |
| LEV-3684SCT-42 | \$1,606 | 178   | 5.41 | 82.75 | 35.5 | 42 |
| LEV-3690SCT-42 | \$1,657 | 185.1 | 5.79 | 88.75 | 35.5 | 42 |
| LEV-3696SCT-42 | \$1,755 | 192.1 | 6.16 | 94.5  | 35.5 | 42 |

**RTA**



| MODEL | LIST | WEIGHT | CUBE            | W  | D  | H  |
|-------|------|--------|-----------------|----|----|----|
|       |      | LBS    | FT <sup>3</sup> | IN | IN | IN |

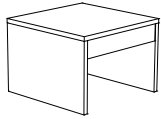

LEV-2424MT

**MAGAZINE TABLE**

|            |              |    |     |       |       |       |
|------------|--------------|----|-----|-------|-------|-------|
| LEV-2424MT | <b>\$398</b> | 30 | 1.4 | 23.75 | 23.75 | 16.75 |
| LEV-2442MT | <b>\$466</b> | 45 | 2.4 | 41.5  | 23.75 | 16.75 |

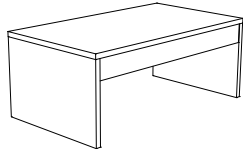

LEV-2442MT

**OVAL TOP COFFEE TABLE**

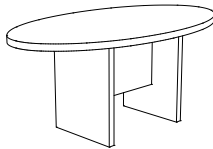

LEV-2240CFT

|             |              |    |     |      |       |       |
|-------------|--------------|----|-----|------|-------|-------|
| LEV-2240CFT | <b>\$697</b> | 40 | 1.4 | 39.5 | 21.75 | 16.75 |
|-------------|--------------|----|-----|------|-------|-------|

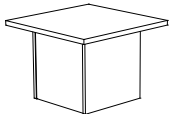

LEV-2424CMT

**CUBE BASE MAGAZINE TABLE**

|             |              |    |     |       |       |       |
|-------------|--------------|----|-----|-------|-------|-------|
| LEV-2424CMT | <b>\$632</b> | 44 | 1.2 | 23.75 | 23.75 | 16.75 |
| LEV-2448CMT | <b>\$700</b> | 66 | 2.4 | 47.25 | 23.75 | 16.75 |

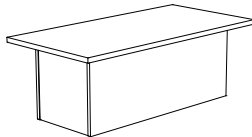

LEV-2448CMT

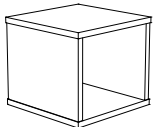

LEV-1818CCFT

**CUBE COFFEE TABLE**

|              |              |      |      |       |       |       |
|--------------|--------------|------|------|-------|-------|-------|
| LEV-1818CCFT | <b>\$537</b> | 32   | 0.97 | 17.75 | 17.75 | 16.75 |
| LEV-1836CCFT | <b>\$587</b> | 48.5 | 1.43 | 35.5  | 17.75 | 16.75 |
| LEV-1848CCFT | <b>\$629</b> | 59.5 | 1.88 | 47.25 | 17.75 | 16.75 |

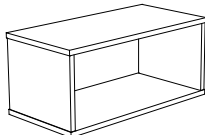

LEV-1836CCFT

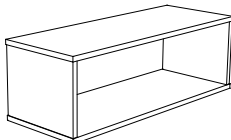

LEV-1848CCFT

**RTA**

LAYOUTS

|  | ITEMS            | ITEM DESCRIPTION                                | LEVELS LIST    |
|--|------------------|---|----------------|
|  | <b>LAYOUT #1</b> |   |                |
|  | LEV-2036WDLFX-21 | 21" HIGH WIDE DRAWER OVER LATERAL FILE - NO TOP | <b>\$1,223</b> |
|  | LEV-2036COX-21   | OPEN CABINET - NO TOP                           | <b>\$801</b>   |
|  | LEV-2072FC       | FILE CABINET TOP                                | <b>\$361</b>   |
|  | LEV-TR3072-LOOP  | TIERED RECTANGULAR BULLET RETURN                | <b>\$878</b>   |
|  |                  | <b>TOTAL</b>                                    | <b>\$3,263</b> |
|  | <b>LAYOUT #2</b> |   |                |
|  | LEV-2036WDLFX-21 | 21" HIGH WIDE DRAWER OVER LATERAL FILE - NO TOP | <b>\$1,223</b> |
|  | LEV-2036COX-21   | OPEN CABINET - NO TOP                           | <b>\$801</b>   |
|  | LEV-2072FC       | FILE CABINET TOP                                | <b>\$361</b>   |
|  | LEV-TR3072-SQ2   | TIERED RECTANGULAR BULLET RETURN                | <b>\$866</b>   |
|  |                  | <b>TOTAL</b>                                    | <b>\$3,251</b> |
|  | <b>LAYOUT #3</b> |   |                |
|  | LEV-3072-CAL-2L  | CALYPSO HEIGHT ADJUSTABLE DESK                  | <b>\$1,993</b> |
|  | LEV-R2436COX-21  | 21" HIGH OPEN CABINET W/ RECESSED BACK- NO TOP  | <b>\$898</b>   |
|  | LEV-2436WDLFX-21 | 21" HIGH WIDE DRAWER OVER LATERAL FILE - NO TOP | <b>\$1,287</b> |
|  | LEV-2472NTOP     | NOTCHED CREDENZA TOP                            | <b>\$497</b>   |
|  |                  | <b>TOTAL</b>                                    | <b>\$4,675</b> |
|  | <b>LAYOUT #4</b> |   |                |
|  | LEV-TR3072-LOOP  | TIERED RECTANGULAR BULLET RETURN                | <b>\$878</b>   |
|  | LEV-2036WDLFX-21 | 21" HIGH WIDE DRAWER OVER LATERAL FILE - NO TOP | <b>\$1,223</b> |
|  | LEV-2036COX-21   | OPEN CABINET - NO TOP                           | <b>\$801</b>   |
|  | LEV-2072FC       | FILE CABINET TOP                                | <b>\$361</b>   |
|  | LEV-TR4372MHHD2  | TIERED HUTCH W/ 2 DOORS & METAL SUPPORTS        | <b>\$1,523</b> |
|  |                  | <b>TOTAL</b>                                    | <b>\$4,786</b> |

|                  | ITEMS               | ITEM DESCRIPTION   | QTY | LEVELS LIST    |                |
|------------------|---------------------|--|-----|----------------|----------------|
|                  | <b>LAYOUT #5</b>    |  |     |                |                |
|                  | LEV-3072-CAL-2L     | CALYPSO HEIGHT ADJUSTABLE DESK                                 |     | \$1,993        |                |
|                  | LEV-R2430COX-21     | 21" HIGH OPEN CABINET W/ RECESSED BACK- NO TOP                 |     | \$852          |                |
|                  | LEV-2436WDLFX-21    | 21" HIGH WIDE DRAWER OVER LATERAL FILE - NO TOP                |     | \$1,287        |                |
|                  | LEV-2466NTOP        | NOTCHED CREDENZA TOP   |     | \$474          |                |
|                  | LEV-1622MPF         | MOBILE PEDESTAL  |     | \$834          |                |
|                  | LEV-MPEDCUSH-ESC    | PEDESTAL CUSHION   |     | \$393          |                |
|                  | LEV-2036CX-SR28     | DOUBLE DOOR CABINET - NO TOP W/ STORAGE RISERS                 | X2  | \$910          |                |
|                  | LEV-3736SBK-20      | STACKING BOOKCASE  | X2  | \$983          |                |
|                  |                     | <b>TOTAL</b>   |     |                | <b>\$9,619</b> |
|                  | <b>LAYOUT #6</b>    |  |     |                |                |
|                  | LEV-3072TBL-LOOP    | TABLE W/ LOOP LEGS   |     | \$915          |                |
|                  | LEV-1460PMPs        | PLEXI MODESTY PANELS   |     | \$525          |                |
|                  | LEV-2436C-SR29      | DOUBLE DOOR CABINET W/ STORAGE RISER                           |     | \$1,014        |                |
|                  | LEV-CO2472WDLF-SR29 | OPEN SHELF/ WIDE DRAWER/LATERAL FILE CREDENZA W/ STORAGE RISER |     | \$1,737        |                |
|                  | LEV-6524CLC-L-24-SR | SINGLE DOOR CLOSET CABINET W/ STORAGE RISER                    |     | \$1,739        |                |
|                  | LEV-6524CLC-R-24-SR | SINGLE DOOR CLOSET CABINET W/ STORAGE RISER                    |     | \$1,739        |                |
|                  | LEV-1772OSHD2       | OVERHEAD STORAGE - W/ 2 DOORS                                  |     | \$1,290        |                |
|                  |                     | <b>TOTAL</b>   |     |                | <b>\$8,959</b> |
|                  |                     | <b>LAYOUT #7</b>   |     |                |                |
| LEV-TR3060-SQ2   |                     | TIERED RECTANGULAR BULLET RETURN                               | X2  | \$826          |                |
| LEV-2030COX-21   |                     | OPEN CABINET - NO TOP  | X2  | \$772          |                |
| LEV-2036CX-21    |                     | 21" HIGH DOUBLE DOOR CABINET - NO TOP                          | X2  | \$852          |                |
| LEV-2066FC       |                     | FILE CABINET TOP   | X2  | \$353          |                |
| LEV-2036CUSH-ESC |                     | SEAT CUSHIONS FOR 21" HIGH CREDENZAS                           | X2  | \$457          |                |
|                  |                     | <b>TOTAL</b>   |     |                | <b>\$6,520</b> |
|                  | <b>LAYOUT #8</b>    |  |     |                |                |
|                  | LEV-TR3072-LOOP     | TIERED RECTANGULAR BULLET RETURN                               |     | \$878          |                |
|                  | LEV-2036WDLFX-21    | 21" HIGH WIDE DRAWER OVER LATERAL FILE - NO TOP                |     | \$1,223        |                |
|                  | LEV-2036COX-21      | OPEN CABINET - NO TOP  |     | \$801          |                |
|                  | LEV-2072FC          | FILE CABINET TOP   |     | \$361          |                |
|                  | LEV-1772OSHD2       | OVERHEAD STORAGE - W/ 2 DOORS                                  |     | \$1,290        |                |
|                  | LEV-6524CLC-L-24    | SINGLE DOOR CLOSET CABINET                                     |     | \$1,862        |                |
|                  | LEV-2036WDLF-22     | 22" HIGH WIDE DRAWER OVER LATERAL FILE                         |     | \$1,262        |                |
|                  | LEV-2036CUSH-ESC    | SEAT CUSHIONS FOR 21" HIGH CREDENZAS                           |     | \$457          |                |
|                  | <b>TOTAL</b>        |  |     | <b>\$8,134</b> |                |

|  | ITEMS                | ITEM DESCRIPTION   | QTY | LEVELS LIST     |
|--|----------------------|--|-----|-----------------|
|  | <b>LAYOUT #9</b>     |  |     |                 |
|  | LEV-TR3072-LOOP      | TIERED RECTANGULAR BULLET RETURN   | X2  | \$878           |
|  | LEV-2036COX-21       | OPEN CABINET - NO TOP  | X2  | \$801           |
|  | LEV-2036CX-21        | 21" HIGH DOUBLE DOOR CABINET - NO TOP  | X2  | \$852           |
|  | LEV-2072FC           | FILE CABINET TOP   | X2  | \$361           |
|  | LEV-2036CUSH-ESC     | SEAT CUSHIONS FOR 21" HIGH CREDENZAS   | X2  | \$457           |
|  | LEV-6524CLC-L-24     | SINGLE DOOR CLOSET CABINET   |     | \$1,862         |
|  | LEV-6524CLC-R-24     | SINGLE DOOR CLOSET CABINET   |     | \$1,862         |
|  | LEV-1772OSHD2        | OVERHEAD STORAGE - W/ 2 DOORS  | X2  | \$1,290         |
|  |                      | <b>TOTAL</b>   |     | <b>\$10,422</b> |
|  | <b>LAYOUT #10</b>    |  |     |                 |
|  | LEV-TR3072-LOOP      | TIERED RECTANGULAR BULLET RETURN   | X4  | \$878           |
|  | LEV-CO2072WDLF-22    | 22" STORAGE CREDENZA   | X2  | \$1,557         |
|  | LEV-WDLF2072CO-22    | 22" STORAGE CREDENZA   | X2  | \$1,557         |
|  | LEV-2836PMPDS        | PLEXI MODESTY/DIVIDER PANELS   | X2  | \$477           |
|  | 388-3630DTS          | DESKTOP OPEN STORAGE   | X4  | \$585           |
|  |                      | <b>TOTAL</b>   |     | <b>\$13,034</b> |
|  | <b>LAYOUT #11</b>    |  |     |                 |
|  | LEV-TR3072-SQ2       | TIERED RECTANGULAR BULLET RETURN   | X2  | \$866           |
|  | LEV-3072TBL-SQ2      | TABLE W/ SQUARE OFFSET LEGS  | X2  | \$885           |
|  | LEV-4460DSH-SQ2      | DIVIDER HUTCH - OPEN SHARED HUTCH W/ SQUARE OFFSET LEGS                            | X2  | \$732           |
|  | LEV-1260PDP          | PLEXI DIVIDER PANELS   | X2  | \$471           |
|  | LEV-1622MPF          | MOBILE PEDESTAL  | X2  | \$834           |
|  | LEV-MPEDCUSH-ESC     | PEDESTAL CUSHION   | X2  | \$393           |
|  | LEV-CO2072FC-22      | 22" CABINET CREDENZA   | X1  | \$1,827         |
|  | LEV-CF2072CO-22      | 22" CABINET CREDENZA   | X1  | \$1,827         |
|  | LEV-1254PDP          | PLEXI DIVIDER PANELS   | X2  | \$436           |
|  |                      | <b>TOTAL</b>   |     | <b>\$12,888</b> |
|  | <b>LAYOUT #12</b>    |  |     |                 |
|  | CAL-3072-7230RCMLD   | ONE PIECE L-SHAPED TOP   |     | \$1,443         |
|  | CAL-E1-3LEG          | HEIGHT ADJUSTABLE 3 LEG BASE   |     | \$1,988         |
|  | CAL-MP1872LAP        | 18" LAMINATE MODESTY PANELS  |     | \$297           |
|  | LEV-CO2072FC-22-AGD  | 22" CABINET CREDENZA W/ AGD DOORS  |     | \$1,827         |
|  |                      | <i>AGD UPCHARGE</i>  |     | \$276           |
|  | LEV-7724OFFWL-24-AGD | OPEN WARDROBE STORAGE - OPEN SHELVES/FILE/FILE/ WARDROBE LEFT W/ AGE WARDROBE DOOR |     | \$2,117         |
|  |                      | <i>AGD UPCHARGE</i>  |     | \$729           |
|  | LEV-1772OSHD2-AGD    | OVERHEAD STORAGE - W/ 2 DOORS - AGD DOORS  |     | \$1,290         |
|  |                      | <i>AGD UPCHARGE</i>  |     | \$532           |
|  | LEV-2036CUSH-ESC     | SEAT CUSHIONS FOR 21" HIGH CREDENZAS   |     | \$457           |
|  |                      | <b>TOTAL</b>   |     | <b>\$10,956</b> |

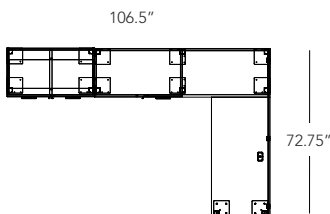
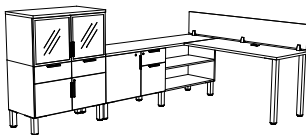
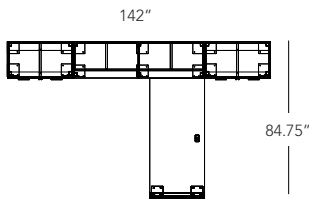
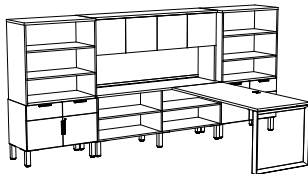
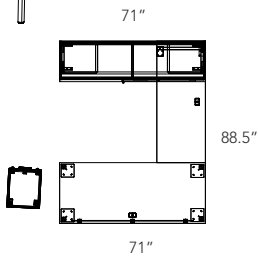
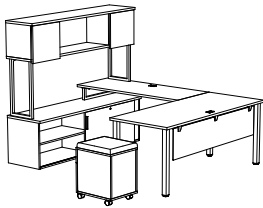
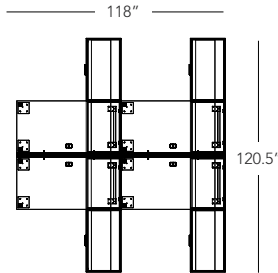
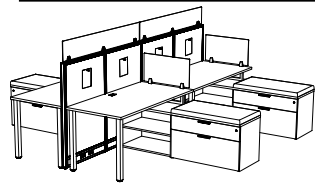

| ITEMS             | ITEM DESCRIPTION                       | LEVELS |                 |
|-------------------|--|--------|-----------------|
|                   |  | QTY    | LIST            |
| <b>LAYOUT #13</b> |  |        |                 |
| LEV-TR3060-SQ2    | TIERED RECTANGULAR BULLET RETURN       | X4     | \$826           |
| LEV-CO2060WDLF-22 | 22" STORAGE CREDENZA                   | X2     | \$1,456         |
| LEV-WDLF2060CO-22 | 22" STORAGE CREDENZA                   | X2     | \$1,456         |
| TM1-1530PLX       | 15" TOP MOUNT PLEXIGLASS PRIVACY PANEL | X4     | \$430           |
| FRM1-1060PLX      | PLEXIGLASS PANEL EXTENSION             | X2     | \$346           |
| FRM-3048P         | 48" TALL PANEL                         | X4     | \$413           |
| FRM-48PET         | PANEL END TRIM                         | X2     | \$29            |
| FRM-PCK           | PANEL CONNECTING KIT                   | X3     | \$40            |
| LEV-2030CUSH-ESC  | SEAT CUSHIONS FOR 21" HIGH CREDENZAS   | X4     | \$457           |
| <b>TOTAL</b>      |  |        | <b>\$15,198</b> |

|                   |  |  |                |
|-------------------|--|--|----------------|
| <b>LAYOUT #14</b> |  |  |                |
| LEV-CO2072SDC-22  | 22" HIGH SLIDING DOOR CREDENZAS          |  | \$1,567        |
| LEV-TR2460BR      | 24" DEEP TIERED BRIDGE                   |  | \$615          |
| LEV-3072TBL-SQ2   | TABLE W/ SQUARE OFFSET LEGS              |  | \$885          |
| LEV-TR4372MHHD2   | TIERED HUTCH W/ 2 DOORS & METAL SUPPORTS |  | \$1,523        |
| LEV-1622MPF       | MOBILE PEDESTAL                          |  | \$834          |
| LEV-MPEDCUSH-ESC  | PEDESTAL CUSHION                         |  | \$393          |
| LEV-1460PMPS      | PLEXI MODESTY PANELS                     |  | \$525          |
| <b>TOTAL</b>      |  |  | <b>\$6,342</b> |

|                   |   |    |                |
|-------------------|---|----|----------------|
| <b>LAYOUT #15</b> |   |    |                |
| LEV-3066RET-LOOP  | RECTANGULAR BULLET RETURN                             |    | \$664          |
| LEV-2072CO-SR29   | OPEN CABINET W/ DIVIDER & STORAGE RISER               |    | \$1,677        |
| LEV-3672HHD4      | 36" HIGH HUTCH W/ 4 DOORS                             |    | \$1,393        |
| LEV-2036DCX-SR28  | DRAWERS OVER DOORS CABINET - NO TOP W/ STORAGE RISERS | X2 | \$1,278        |
| LEV-3736SBK-20    | STACKING BOOKCASE                                     | X2 | \$983          |
| <b>TOTAL</b>      |   |    | <b>\$8,256</b> |

|                      |   |  |                |
|----------------------|---|--|----------------|
| <b>LAYOUT #16</b>    |   |  |                |
| LEV-CF2072CO-SR29    | CABINET CREDENZA W/ STORAGE RISER                     |  | \$1,914        |
| LEV-2454RET-SQ2      | RECTANGULAR BULLET RETURN                             |  | \$471          |
| LEV-2036DCX-SR28     | DRAWERS OVER DOORS CABINET - NO TOP W/ STORAGE RISERS |  | \$1,278        |
| LEV-2036STC-20 - AGD | STACKING CABINET W/ AGD DOORS                         |  | \$900          |
|                      | AGD UPCHARGE  |  | \$613          |
| LEV-1272PDP          | PLEXI DIVIDER PANELS                                  |  | \$567          |
| <b>TOTAL</b>         |   |  | <b>\$5,743</b> |

| ITEMS             | ITEM DESCRIPTION                 | LEVELS |                 |
|-------------------|----------------------------------|--------|-----------------|
|                   |                                  | QTY    | LIST            |
| <b>LAYOUT #17</b> |                                  |        |                 |
| LEV-TR2472-LOOP   | TIERED RECTANGULAR BULLET RETURN | X3     | \$828           |
| LEV-CO2072WDLF-22 | 22" STORAGE CREDENZA             |        | \$1,557         |
| LEV-WDLF2072CO-22 | 22" STORAGE CREDENZA             |        | \$1,557         |
| LEV-2036CO-22     | 22' HIGH OPEN CABINET            |        | \$845           |
| FRM-48SQP-2W      | SQUARE 2 WAY CONNECTING POST     |        | \$90            |
| FRM-48SQP-3W      | SQUARE 3 WAY CONNECTING POST     |        | \$104           |
| FRM-3648P         | 48" TALL PANEL                   | X9     | \$490           |
| FRM-48PET         | PANEL END TRIM                   | X3     | \$29            |
| FRM-PCK           | PANEL CONNECTING KIT             | X5     | \$40            |
| <b>TOTAL</b>      |                                  |        | <b>\$11,334</b> |

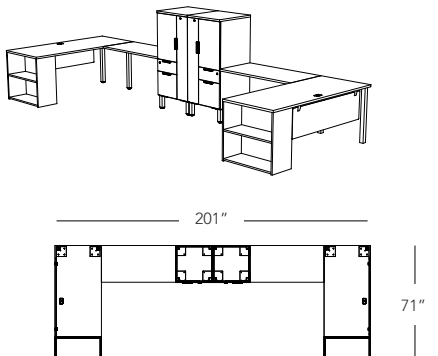
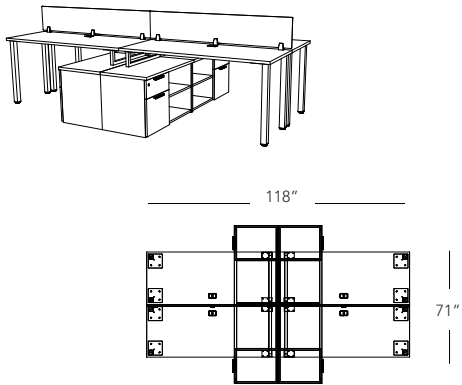
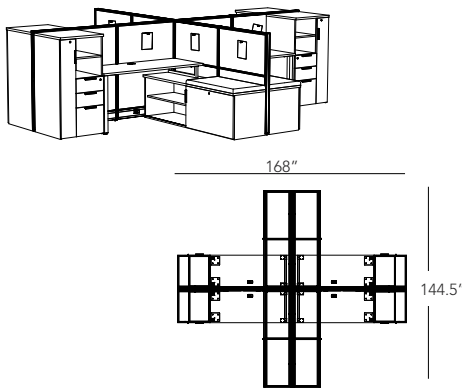
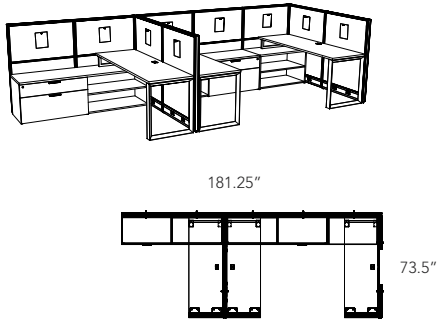

| ITEMS | ITEM DESCRIPTION | LEVELS LIST |
|-------|------------------|-------------|
|-------|------------------|-------------|

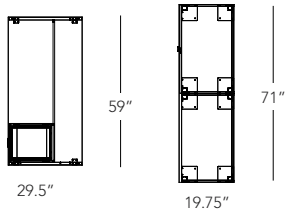
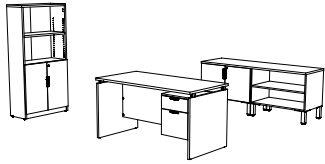

**LAYOUT #21**

|                         |  |              |
|-------------------------|--|--------------|
| <b>LEV-2036CX-SR28</b>  | DOUBLE DOOR CABINET - NO TOP W/ STORAGE RISERS | <b>\$910</b> |
| <b>LEV-2036COX-SR28</b> | OPEN CABINET - NO TOP W/ STORAGE RISERS        | <b>\$859</b> |
| <b>LEV-2072FC</b>       | FILE CABINET TOP                               | <b>\$361</b> |

**\*\*HDL PRODUCTS**

|                      |                                 |              |
|----------------------|---------------------------------|--------------|
| <b>LEV-32BKDRS</b>   | OPTIONAL DOORS FOR BOOKCASE     | <b>\$205</b> |
| <b>LEV-6532BK</b>    | BOOKCASE                        | <b>\$561</b> |
| <b>MA-12-3060-WW</b> | MIRA LARGE SINGLE PEDESTAL DESK | <b>\$699</b> |

TOTAL **\$3,595**

**\*\*HDL PRODUCTS AVAILABLE IN SELECT FINISHES ONLY**

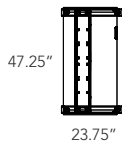
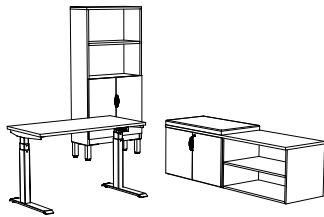

**LAYOUT #22**

|                         |                                       |                |
|-------------------------|---------------------------------------|----------------|
| <b>LEV-2448-CAL-2L</b>  | CALYPSO HEIGHT ADJUSTABLE DESK        | <b>\$1,784</b> |
| <b>LEV-2036CX-21</b>    | 21" HIGH DOUBLE DOOR CABINET - NO TOP | <b>\$852</b>   |
| <b>LEV-2036COX-21</b>   | OPEN CABINET - NO TOP                 | <b>\$801</b>   |
| <b>LEV-2072FC</b>       | FILE CABINET TOP                      | <b>\$361</b>   |
| <b>LEV-2036CUSH-ESC</b> | SEAT CUSHIONS FOR 21" HIGH CREDENZAS  | <b>\$457</b>   |

**\*\*HDL PRODUCTS**

|                     |                             |              |
|---------------------|-----------------------------|--------------|
| <b>LEV-SR7232BK</b> | BOOKCASE                    | <b>\$724</b> |
| <b>LEV-32BKDRS</b>  | OPTIONAL DOORS FOR BOOKCASE | <b>\$205</b> |

TOTAL **\$5,184**

**\*\*HDL PRODUCTS AVAILABLE IN SELECT FINISHES ONLY**

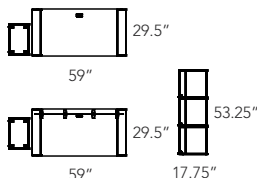
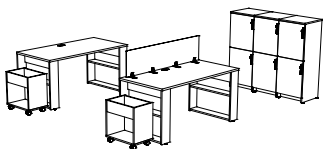

**LAYOUT #23**

|                         |  |    |                |
|-------------------------|--|----|----------------|
| <b>LEV-3060TBL-SOX2</b> | 30" DEEP TABLE W/ 2 X SHELF OPEN                 | X2 | <b>\$1,002</b> |
| <b>388-1320MSO-22</b>   | MOBILE STORAGE OPEN                              | X2 | <b>\$743</b>   |
| <b>FS1-1560PLX</b>      | 15" FREE STANDING PLEXIGLASS PRIVACY PANEL       |    | <b>\$536</b>   |
| <b>LOC-6518CLH2-18</b>  | 65" TALL - LEFT HINGE, SINGLE WIDE 2 DOOR LOCKER | X3 | <b>\$1,664</b> |

TOTAL **\$9,018**

**LEVELS SERIES**  
**NOTES:**

---



# RECEPTION SERIES

This is a metric series (imperial sizing available). Please refer to page [INDEX-1](#) for details

|   |                        |
|---|------------------------|
| <b>Laminate Gallery Reception</b> .....               |                        |
| Gallery Details & Ordering Instructions .....         | <a href="#">REC-4</a>  |
| <b>Product by Category</b> .....                      |                        |
| <b>Desks &amp; Connectors- 24"</b> .....              |                        |
| Freestanding Gallery Desks .....                      | <a href="#">REC-6</a>  |
| Left/Right Gallery Connectors .....                   | <a href="#">REC-7</a>  |
| Cutback Gallery Connectors .....                      | <a href="#">REC-9</a>  |
| <b>Desks &amp; Connectors- 30"</b> .....              |                        |
| Freestanding Gallery Desks .....                      | <a href="#">REC-11</a> |
| Left/Right Gallery Connectors .....                   | <a href="#">REC-12</a> |
| Cutback Gallery Connectors .....                      | <a href="#">REC-14</a> |
| <b>Corner Modules</b> .....                           |                        |
| Standard Gallery Corner Modules- 18, 24 & 30" .....   | <a href="#">REC-16</a> |
| Neo-Angle Gallery Corner Module .....                 | <a href="#">REC-17</a> |
| Neo-Angle Gallery Corner Wedges .....                 | <a href="#">REC-17</a> |
| <b>Gallery Tops</b> .....                             |                        |
| Neo-Angle Gallery Transaction Top .....               | <a href="#">REC-17</a> |
| Neo-Angle Gallery Wedge Transaction Tops .....        | <a href="#">REC-17</a> |
| Bow Front Gallery Tops .....                          | <a href="#">REC-18</a> |
| Straight Gallery Tops .....                           | <a href="#">REC-18</a> |
| <b>Gallery Curved &amp; Waterfall Reception</b> ..... |                        |
| <b>Curved Corner Modules</b> .....                    |                        |
| Curved Waterfall Gallery Corner Modules .....         | <a href="#">REC-20</a> |
| Curved Gallery Corner Modules .....                   | <a href="#">REC-21</a> |
| Desk Height Curved Corner Modules .....               | <a href="#">REC-22</a> |

**continued...**

|  |                        |
|--|------------------------|
| <b>Height Adjustable Connectors/Desking</b> .....          |                        |
| Height Adjustable Waterfall Gallery Connectors .....       | <a href="#">REC-23</a> |
| Height Adjustable Gallery Connectors .....                 | <a href="#">REC-24</a> |
| <b>Connectors/Desking</b> .....                            |                        |
| Waterfall Gallery Connectors .....                         | <a href="#">REC-25</a> |
| Gallery Connectors .....                                   | <a href="#">REC-25</a> |
| Transaction Tops .....                                     | <a href="#">REC-26</a> |
| Desk Height Connectors .....                               | <a href="#">REC-26</a> |
| <b>Modern Reception</b> .....                              |                        |
| Modern Reception Desk & Return .....                       | <a href="#">REC-28</a> |
| Modern Reception Desk & Return for Height-Adjustable ..... | <a href="#">REC-29</a> |
| <b>Add-on Laminate Components for Reception</b> .....      |                        |
| <b>Product by Category</b> .....                           |                        |
| Transaction Tops .....                                     | <a href="#">REC-30</a> |
| Desktop Storage .....                                      | <a href="#">REC-31</a> |
| Horizontal Cubby-Hole .....                                | <a href="#">REC-31</a> |
| Gallery Transaction Shells .....                           | <a href="#">REC-32</a> |
| <b>Outlines Reception</b> .....                            |                        |
| Outlines Details .....                                     | <a href="#">REC-33</a> |
| <b>Layouts</b> .....                                       |                        |
| Laminate Gallery Reception .....                           | <a href="#">REC-34</a> |
| Curved Gallery Reception .....                             | <a href="#">REC-34</a> |
| Laminate & Outlines Reception .....                        | <a href="#">REC-36</a> |
| Curved Reception .....                                     | <a href="#">REC-41</a> |

Reception Series consolidates the numerous reception concepts available at Heartwood Manufacturing into one place.

**Laminate Gallery Reception**

Formerly 388 Gallery, this reception concept presents various configurations of extended laminate backs and gables, giving you the privacy you need where you need it. Gallery tops can be added to create a client transaction space or present a different look.

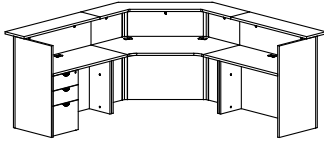

**Curved Laminate Reception**

Curved reception desks featuring waterfall transaction counters, curved classic gallery desking and specialized desking for height-adjustable.

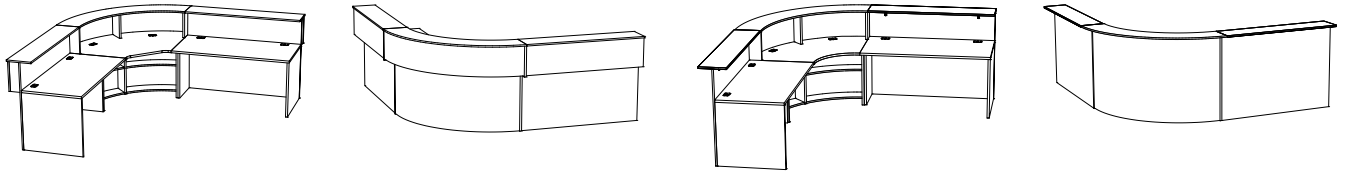

**Modern Reception**

Reception desk featuring waterfall transaction counters and a two-tone colour design.

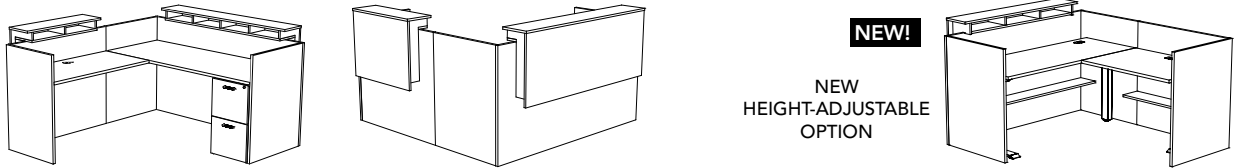

**Add-on Laminate Components for Reception**

Service counter and storage concepts when designing your reception workspace.

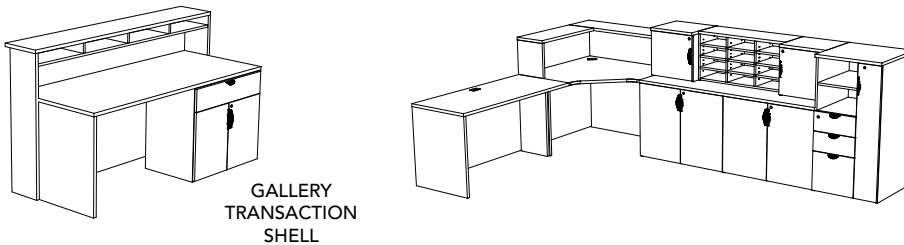

**Outlines Reception**

Outlines Series is a robust desktop mounted privacy panel series with many applications. The nature of the Outlines Series inherently lends itself to reception workspaces where division is needed between client services and the client. With the numerous design elements encompassed by this series, be sure to find the look that is right for you.

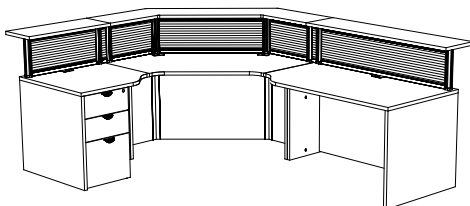

**NOTE:** Information is current at time of print. For up to date information check online at [www.heartwood.ca](http://www.heartwood.ca).

Heartwood's Gallery components are characterized by their extended back and gables making them a natural choice for reception workstations. Almost any 388/600 desking unit can be made into gallery and when coupled with our newly expanded 388/600 storage options, the design choices in Gallery are limitless.

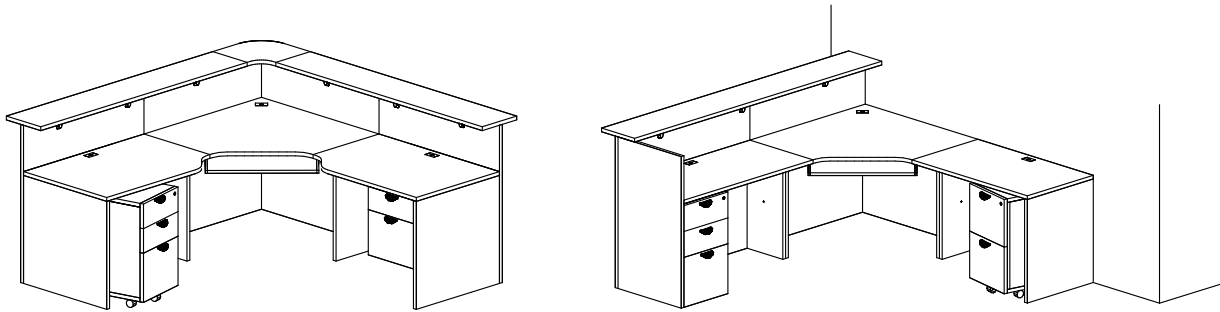

**IT'S SIMPLE, HERE'S HOW IT WORKS**

Heartwood has developed a simple system for identifying RTA (ready-to-assemble) Gallery components. Please take a few minutes to read and familiarize yourself with the instructions below.

- ♥ When ordering RTA Gallery components, all sides must be identified using the following letter codes:
  - > "G" (42" high Tall Back or Tall Gable)
  - > "A" (standard Full Gable for a 29" high unit)
  - > "C" (standard Connecting Gable for a 29" high unit)
  - > "M" (standard Full Modesty Panel for a 29" high unit)

♥ Always indicate the configuration in a clockwise direction, starting from the left, if you were sitting at it.

**EXAMPLES:**

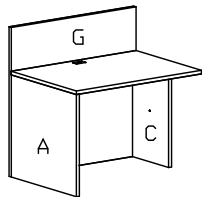

**388-3042CT-AGC**

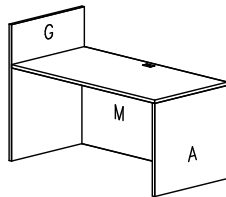

**388-2448CT-GMA**

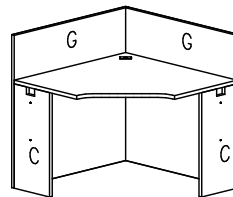

**388-2442CM-CGGC**

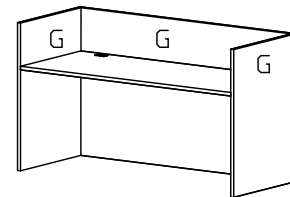

**388-3048CT-GGG**

**388-3042CT-AGC=**

- > "388-3042CT" (30x42" Gallery Connector) with
- > "A" (standard Full Gable for a 29" high unit) on left with
- > "G" (42" high Tall Back) with
- > "C" (standard Connecting Gable for a 29" high unit) on right

♥ Most standard Connector Tops or Corner Modules can be manufactured in the RTA Gallery style. The only exceptions are Extended Corner Modules, so please use standard Corner Modules and Connector Tops in combination.

♥ We have restricted the length of any connecting unit to 60" to avoid graining conflicts.

♥ Any unit with a "C" gable indicated in the model number will have vertical grain on the Tall Gallery Gables and Backs.

♥ Sizes over 60" are available in non-connecting units. For example, a 388-3072CT-GGG is possible, a 388-3072CT-CGG is not. The retail price list follows these guidelines, so if it's in the price book, you can order it

♥ All specifications for 388/600, as described in the Series Specifications & Descriptions starting page [388-3](#) pertain to the RTA Gallery Series except where there is a Tall Back which is then 1" material. Drawer pedestals etc. should be ordered from the 388/600 series.

♥ Gallery backs can be ordered up to 84" high. Please contact Customer Service for pricing.

- ♥ Solid colour, woodgrain or two-tone combinations available.
- ♥ 600 Series units maintain the same overall gable height as 388 Series units but the desk height worksurface thickness increases by 1/2".
- ♥ 600 Series transaction tops are 1 1/2" and will increase the overall height of Gallery units by 1/2" when added.
- RTA** As you might expect, all RTA Gallery units ship RTA.

**ORDERING GALLERY TOPS FOR LAMINATE CORNER GALLERIES**

- ♥ Gallery Transaction Tops have a 5 7/16" outside and 5 7/16" inside overhang when installed.
- ♥ To get the length of the straight Gallery Top section on either side of the Radius Corner Insert, subtract 12" from the combined unit length on each side.

SEE PLAN VIEW EXAMPLE BELOW:

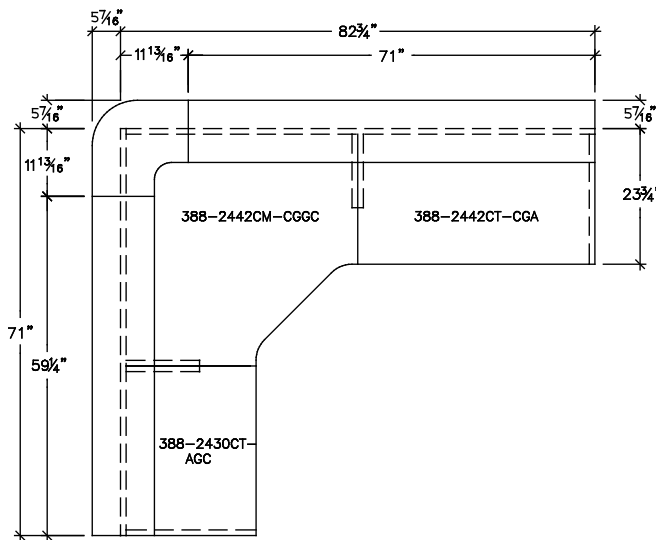

**PLAN VIEW EXAMPLE**

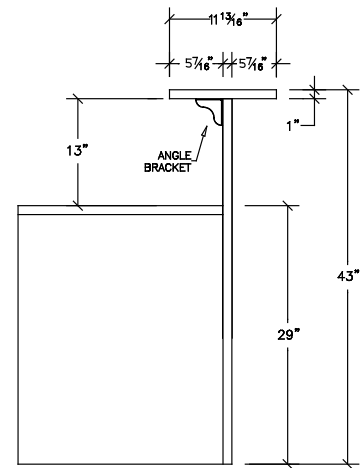

**SIDE VIEW EXAMPLE**

- > Right side: 42CM + 42CT = 84 - 12 = **388-1272GT**
- > Left side: 30CT + 42CM = 72 - 12 = **388-1260GT**

**RECEPTION SERIES DESKS & CONNECTORS- 24"**  
**FREESTANDING LAMINATE GALLERY DESKS**

| MODEL | LIST     | LIST      | WEIGHT | CUBE            | W  | D  | H  |
|-------|----------|-----------|--------|-----------------|----|----|----|
|       | 388 (1") | 600 (1½") | LBS    | FT <sup>3</sup> | IN | IN | IN |

**24" FREESTANDING GALLERY DESK**

W/ TALL BACK & GABLES

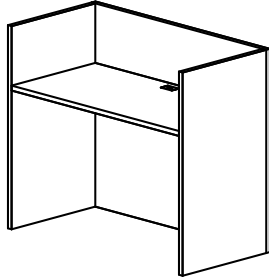

|                |         |         |     |     |       |       |    |
|----------------|---------|---------|-----|-----|-------|-------|----|
| 388-2436CT-GGG | \$983   | \$1,121 | 105 | 2.8 | 35.5  | 23.75 | 42 |
| 388-2442CT-GGG | \$1,021 | \$1,164 | 111 | 3.3 | 41.5  | 23.75 | 42 |
| 388-2448CT-GGG | \$1,074 | \$1,224 | 128 | 3.8 | 47.25 | 23.75 | 42 |
| 388-2454CT-GGG | \$1,116 | \$1,272 | 137 | 4.2 | 53.25 | 23.75 | 42 |
| 388-2460CT-GGG | \$1,145 | \$1,305 | 146 | 4.7 | 59.25 | 23.75 | 42 |
| 388-2466CT-GGG | \$1,213 | \$1,383 | 155 | 5.1 | 65    | 23.75 | 42 |
| 388-2472CT-GGG | \$1,283 | \$1,463 | 164 | 5.6 | 71    | 23.75 | 42 |

W/ TALL LEFT GABLE & BACK, FULL RIGHT GABLE

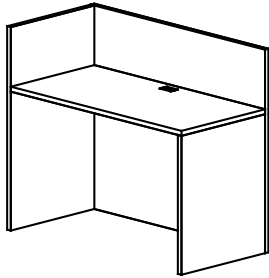

|                |         |         |     |     |       |       |    |
|----------------|---------|---------|-----|-----|-------|-------|----|
| 388-2448CT-GGA | \$1,006 | \$1,147 | 120 | 3.8 | 47.25 | 23.75 | 42 |
| 388-2454CT-GGA | \$1,047 | \$1,194 | 129 | 4.2 | 53.25 | 23.75 | 42 |
| 388-2460CT-GGA | \$1,074 | \$1,224 | 138 | 4.7 | 59.25 | 23.75 | 42 |
| 388-2466CT-GGA | \$1,138 | \$1,297 | 146 | 5.1 | 65    | 23.75 | 42 |
| 388-2472CT-GGA | \$1,202 | \$1,370 | 156 | 5.6 | 71    | 23.75 | 42 |

W/ FULL LEFT GABLE, TALL BACK & RIGHT GABLE

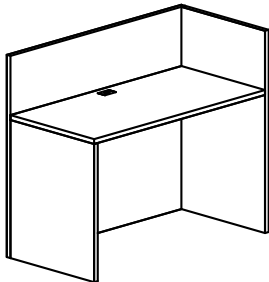

|                |         |         |     |     |       |       |    |
|----------------|---------|---------|-----|-----|-------|-------|----|
| 388-2448CT-AGG | \$1,006 | \$1,147 | 120 | 3.8 | 47.25 | 23.75 | 42 |
| 388-2454CT-AGG | \$1,047 | \$1,194 | 129 | 4.2 | 53.25 | 23.75 | 42 |
| 388-2460CT-AGG | \$1,074 | \$1,224 | 138 | 4.7 | 59.25 | 23.75 | 42 |
| 388-2466CT-AGG | \$1,138 | \$1,297 | 146 | 5.1 | 65    | 23.75 | 42 |
| 388-2472CT-AGG | \$1,202 | \$1,370 | 156 | 5.6 | 71    | 23.75 | 42 |

W/ FULL LEFT GABLE, TALL BACK, FULL RIGHT GABLE

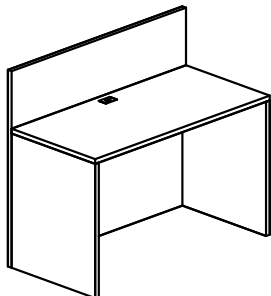

|                |         |         |     |     |       |       |    |
|----------------|---------|---------|-----|-----|-------|-------|----|
| 388-2436CT-AGA | \$861   | \$982   | 99  | 2.8 | 35.5  | 23.75 | 42 |
| 388-2442CT-AGA | \$893   | \$1,018 | 105 | 3.3 | 41.5  | 23.75 | 42 |
| 388-2448CT-AGA | \$939   | \$1,070 | 112 | 3.8 | 47.25 | 23.75 | 42 |
| 388-2454CT-AGA | \$977   | \$1,114 | 121 | 4.2 | 53.25 | 23.75 | 42 |
| 388-2460CT-AGA | \$1,003 | \$1,143 | 130 | 4.7 | 59.25 | 23.75 | 42 |
| 388-2466CT-AGA | \$1,061 | \$1,210 | 136 | 5.1 | 65    | 23.75 | 42 |
| 388-2472CT-AGA | \$1,123 | \$1,280 | 148 | 5.6 | 71    | 23.75 | 42 |

**RTA**

| MODEL | LIST     | LIST      | WEIGHT | CUBE            | W  | D  | H  |
|-------|----------|-----------|--------|-----------------|----|----|----|
|       | 388 (1") | 600 (1½") | LBS    | FT <sup>3</sup> | IN | IN | IN |

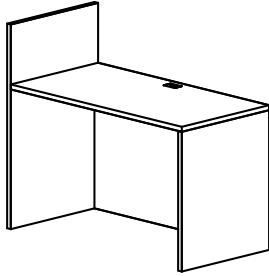

**24" FREESTANDING GALLERY DESK**

W/ TALL LEFT GABLE, FULL MP, FULL RIGHT GABLE

|                |         |         |     |     |       |       |    |
|----------------|---------|---------|-----|-----|-------|-------|----|
| 388-2448CT-GMA | \$939   | \$1,070 | 112 | 3.8 | 47.25 | 23.75 | 42 |
| 388-2454CT-GMA | \$977   | \$1,114 | 121 | 4.2 | 53.25 | 23.75 | 42 |
| 388-2460CT-GMA | \$1,003 | \$1,143 | 130 | 4.7 | 59.25 | 23.75 | 42 |
| 388-2466CT-GMA | \$1,061 | \$1,210 | 137 | 4.8 | 65    | 23.75 | 42 |
| 388-2472CT-GMA | \$1,123 | \$1,280 | 148 | 5.6 | 71    | 23.75 | 42 |

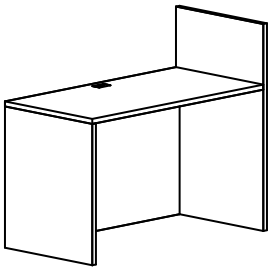

W/ FULL LEFT GABLE, FULL MP, TALL RIGHT GABLE

|                |         |         |     |     |       |       |    |
|----------------|---------|---------|-----|-----|-------|-------|----|
| 388-2448CT-AMG | \$939   | \$1,070 | 112 | 3.8 | 47.25 | 23.75 | 42 |
| 388-2454CT-AMG | \$977   | \$1,114 | 121 | 4.2 | 53.25 | 23.75 | 42 |
| 388-2460CT-AMG | \$1,003 | \$1,143 | 130 | 4.7 | 59.25 | 23.75 | 42 |
| 388-2466CT-AMG | \$1,061 | \$1,210 | 137 | 4.8 | 65    | 23.75 | 42 |
| 388-2472CT-AMG | \$1,123 | \$1,280 | 148 | 5.6 | 71    | 23.75 | 42 |

**LEFT/RIGHT GALLERY CONNECTORS**

**GALLERY CONNECTORS- RIGHT HAND**

W/ LEFT CONNECTING GABLE, TALL BACK & RIGHT GABLE

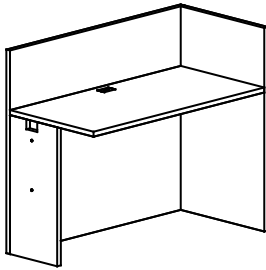

|                |         |         |     |     |       |       |    |
|----------------|---------|---------|-----|-----|-------|-------|----|
| 388-2424CT-CGG | \$865   | \$986   | 95  | 2.4 | 23.75 | 23.75 | 42 |
| 388-2430CT-CGG | \$865   | \$986   | 95  | 2.4 | 29.5  | 23.75 | 42 |
| 388-2436CT-CGG | \$921   | \$1,050 | 102 | 2.8 | 35.5  | 23.75 | 42 |
| 388-2442CT-CGG | \$956   | \$1,090 | 111 | 3.3 | 41.5  | 23.75 | 42 |
| 388-2448CT-CGG | \$1,006 | \$1,147 | 120 | 3.8 | 47.25 | 23.75 | 42 |
| 388-2454CT-CGG | \$1,047 | \$1,194 | 129 | 4.2 | 53.25 | 23.75 | 42 |
| 388-2460CT-CGG | \$1,074 | \$1,224 | 138 | 4.7 | 59.25 | 23.75 | 42 |

W/ LEFT CONNECTING GABLE, TALL BACK, FULL RIGHT GABLE

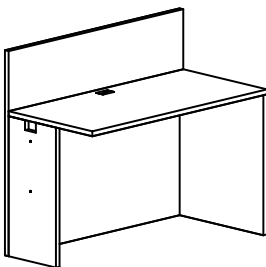

|                |         |         |     |     |       |       |    |
|----------------|---------|---------|-----|-----|-------|-------|----|
| 388-2424CT-CGA | \$809   | \$922   | 80  | 2   | 23.75 | 23.75 | 42 |
| 388-2430CT-CGA | \$809   | \$922   | 88  | 2.2 | 29.5  | 23.75 | 42 |
| 388-2436CT-CGA | \$861   | \$982   | 95  | 2.8 | 35.5  | 23.75 | 42 |
| 388-2442CT-CGA | \$893   | \$1,018 | 104 | 3.1 | 41.5  | 23.75 | 42 |
| 388-2448CT-CGA | \$939   | \$1,070 | 112 | 3.5 | 47.25 | 23.75 | 42 |
| 388-2454CT-CGA | \$977   | \$1,114 | 120 | 3.9 | 53.25 | 23.75 | 42 |
| 388-2460CT-CGA | \$1,003 | \$1,143 | 129 | 4.3 | 59.25 | 23.75 | 42 |

**RTA**

**RECEPTION SERIES DESKS & CONNECTORS- 24"**  
**LAMINATE LEFT/RIGHT GALLERY CONNECTORS**

| MODEL | LIST     | LIST      | WEIGHT | CUBE            | W  | D  | H  |
|-------|----------|-----------|--------|-----------------|----|----|----|
|       | 388 (1") | 600 (1½") | LBS    | FT <sup>3</sup> | IN | IN | IN |

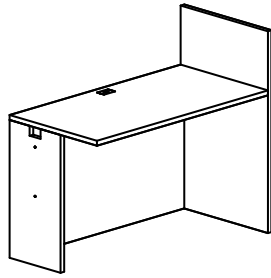

**GALLERY CONNECTORS- RIGHT HAND**

W/ LEFT CONNECTING GABLE, FULL MP, TALL RIGHT GABLE

|                |         |         |     |     |       |       |    |
|----------------|---------|---------|-----|-----|-------|-------|----|
| 388-2448CT-CMG | \$939   | \$1,070 | 112 | 3.5 | 47.25 | 23.75 | 42 |
| 388-2454CT-CMG | \$977   | \$1,114 | 120 | 3.9 | 53.25 | 23.75 | 42 |
| 388-2460CT-CMG | \$1,003 | \$1,143 | 129 | 4.3 | 59.25 | 23.75 | 42 |

**GALLERY CONNECTORS- LEFT HAND**

W/ TALL LEFT GABLE & BACK, RIGHT CONNECTING GABLE

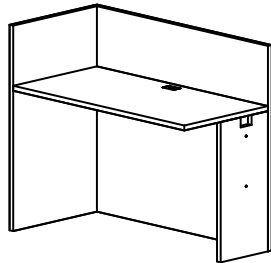

|                |         |         |     |     |       |       |    |
|----------------|---------|---------|-----|-----|-------|-------|----|
| 388-2424CT-GGC | \$865   | \$986   | 95  | 2.4 | 23.75 | 23.75 | 42 |
| 388-2430CT-GGC | \$865   | \$986   | 95  | 2.4 | 29.5  | 23.75 | 42 |
| 388-2436CT-GGC | \$921   | \$1,050 | 129 | 2.8 | 35.5  | 23.75 | 42 |
| 388-2442CT-GGC | \$956   | \$1,090 | 111 | 3.3 | 41.5  | 23.75 | 42 |
| 388-2448CT-GGC | \$1,006 | \$1,147 | 120 | 3.8 | 47.25 | 23.75 | 42 |
| 388-2454CT-GGC | \$1,047 | \$1,194 | 129 | 4.2 | 53.25 | 23.75 | 42 |
| 388-2460CT-GGC | \$1,074 | \$1,224 | 138 | 4.7 | 59.25 | 23.75 | 42 |

W/ FULL LEFT GABLE, TALL BACK, RIGHT CONNECTING GABLE

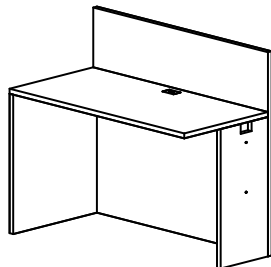

|                |         |         |     |     |       |       |    |
|----------------|---------|---------|-----|-----|-------|-------|----|
| 388-2424CT-AGC | \$809   | \$922   | 80  | 2   | 23.75 | 23.75 | 42 |
| 388-2430CT-AGC | \$809   | \$922   | 88  | 2.2 | 29.5  | 23.75 | 42 |
| 388-2436CT-AGC | \$861   | \$982   | 95  | 2.8 | 35.5  | 23.75 | 42 |
| 388-2442CT-AGC | \$893   | \$1,018 | 104 | 3.1 | 41.5  | 23.75 | 42 |
| 388-2448CT-AGC | \$939   | \$1,070 | 112 | 3.5 | 47.25 | 23.75 | 42 |
| 388-2454CT-AGC | \$977   | \$1,114 | 120 | 3.9 | 53.25 | 23.75 | 42 |
| 388-2460CT-AGC | \$1,003 | \$1,143 | 129 | 4.3 | 59.25 | 23.75 | 42 |

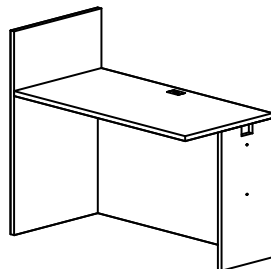

W/ TALL LEFT GABLE, FULL MP, RIGHT CONNECTING GABLE

|                |         |         |     |     |       |       |    |
|----------------|---------|---------|-----|-----|-------|-------|----|
| 388-2448CT-GMC | \$939   | \$1,070 | 112 | 3.5 | 47.25 | 23.75 | 42 |
| 388-2454CT-GMC | \$977   | \$1,114 | 120 | 3.9 | 53.25 | 23.75 | 42 |
| 388-2460CT-GMC | \$1,003 | \$1,143 | 129 | 4.3 | 59.25 | 23.75 | 42 |

**GALLERY CONNECTOR**

W/ LEFT CONNECTING GABLE, TALL BACK, RIGHT CONNECTING GABLE

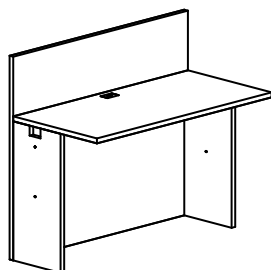

|                |         |         |     |     |       |       |    |
|----------------|---------|---------|-----|-----|-------|-------|----|
| 388-2436CT-CGC | \$861   | \$982   | 96  | 2.8 | 35.5  | 23.75 | 42 |
| 388-2442CT-CGC | \$893   | \$1,018 | 104 | 3.1 | 41.5  | 23.75 | 42 |
| 388-2448CT-CGC | \$939   | \$1,070 | 112 | 3.5 | 47.25 | 23.75 | 42 |
| 388-2454CT-CGC | \$977   | \$1,114 | 125 | 4   | 53.25 | 23.75 | 42 |
| 388-2460CT-CGC | \$1,003 | \$1,143 | 129 | 4.3 | 59.25 | 23.75 | 42 |

**RTA**



| MODEL | LIST     | LIST      | WEIGHT | CUBE            | W  | D  | H  |
|-------|----------|-----------|--------|-----------------|----|----|----|
|       | 388 (1") | 600 (1½") | LBS    | FT <sup>3</sup> | IN | IN | IN |

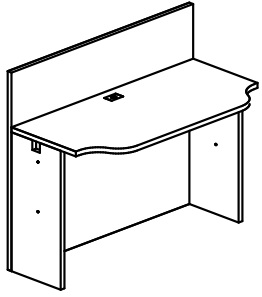

**CUTBACK GALLERY CONNECTOR**

W/ LEFT CONNECTING GABLE, TALL BACK, RIGHT CONNECTING GABLE

|                   |         |         |     |     |       |       |    |
|-------------------|---------|---------|-----|-----|-------|-------|----|
| 388-2442CC-CD-CGC | \$965   | \$1,100 | 104 | 3.1 | 41.5  | 23.75 | 42 |
| 388-2448CC-CD-CGC | \$1,010 | \$1,151 | 112 | 3.5 | 47.25 | 23.75 | 42 |
| 388-2454CC-CD-CGC | \$1,070 | \$1,220 | 120 | 3.9 | 53.25 | 23.75 | 42 |
| 388-2460CC-CD-CGC | \$1,079 | \$1,230 | 129 | 4.3 | 59.25 | 23.75 | 42 |

**CUTBACK GALLERY CONNECTOR- RIGHT HAND**

W/ LEFT CONNECTING GABLE, TALL BACK & RIGHT GABLE,

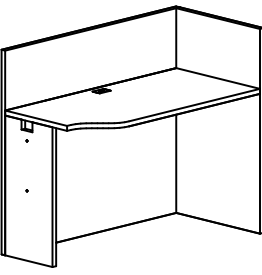

|                   |         |         |     |     |       |       |    |
|-------------------|---------|---------|-----|-----|-------|-------|----|
| 388-2424RC-CL-CGG | \$918   | \$1,047 | 95  | 2.4 | 23.75 | 23.75 | 42 |
| 388-2430RC-CL-CGG | \$918   | \$1,047 | 95  | 2.4 | 29.5  | 23.75 | 42 |
| 388-2436RC-CL-CGG | \$971   | \$1,107 | 102 | 3   | 35.5  | 23.75 | 42 |
| 388-2442RC-CL-CGG | \$1,006 | \$1,147 | 111 | 3.3 | 41.5  | 23.75 | 42 |
| 388-2448RC-CL-CGG | \$1,054 | \$1,202 | 120 | 3.8 | 47.25 | 23.75 | 42 |
| 388-2454RC-CL-CGG | \$1,096 | \$1,249 | 129 | 4.2 | 53.25 | 23.75 | 42 |
| 388-2460RC-CL-CGG | \$1,117 | \$1,273 | 138 | 4.7 | 59.25 | 23.75 | 42 |

W/ LEFT CONNECTING GABLE, TALL BACK, FULL RIGHT GABLE

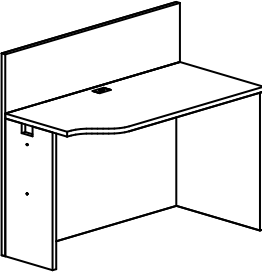

|                   |         |         |     |     |       |       |    |
|-------------------|---------|---------|-----|-----|-------|-------|----|
| 388-2424RC-CL-CGA | \$856   | \$976   | 80  | 2   | 23.75 | 23.75 | 42 |
| 388-2430RC-CL-CGA | \$856   | \$976   | 88  | 2.2 | 29.5  | 23.75 | 42 |
| 388-2436RC-CL-CGA | \$905   | \$1,032 | 95  | 2.8 | 35.5  | 23.75 | 42 |
| 388-2442RC-CL-CGA | \$939   | \$1,070 | 104 | 3.1 | 41.5  | 23.75 | 42 |
| 388-2448RC-CL-CGA | \$983   | \$1,121 | 112 | 3.5 | 47.25 | 23.75 | 42 |
| 388-2454RC-CL-CGA | \$1,022 | \$1,165 | 120 | 3.9 | 53.25 | 23.75 | 42 |
| 388-2460RC-CL-CGA | \$1,044 | \$1,190 | 129 | 4.3 | 59.25 | 23.75 | 42 |

W/ LEFT CONNECTING GABLE, FULL MP, TALL RIGHT GABLE

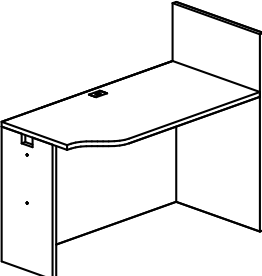

|                   |         |         |     |     |       |       |    |
|-------------------|---------|---------|-----|-----|-------|-------|----|
| 388-2448RC-CL-CMG | \$983   | \$1,121 | 112 | 3.5 | 47.25 | 23.75 | 42 |
| 388-2454RC-CL-CMG | \$1,022 | \$1,165 | 120 | 3.9 | 53.25 | 23.75 | 42 |
| 388-2460RC-CL-CMG | \$1,044 | \$1,190 | 129 | 4.3 | 59.25 | 23.75 | 42 |

**RTA**

**RECEPTION SERIES DESKS & CONNECTORS- 24"**  
**CUTBACK LAMINATE GALLERY CONNECTORS**

| MODEL | LIST     | LIST      | WEIGHT | CUBE            | W  | D  | H  |
|-------|----------|-----------|--------|-----------------|----|----|----|
|       | 388 (1") | 600 (1½") | LBS    | FT <sup>3</sup> | IN | IN | IN |

**CUTBACK GALLERY CONNECTOR- LEFT HAND**

W/ TALL LEFT GABLE & BACK, RIGHT CONNECTING GABLE,

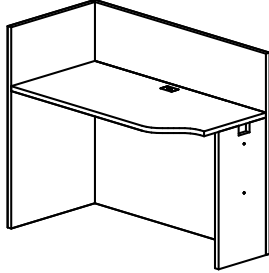

|                   |         |         |     |     |       |       |    |
|-------------------|---------|---------|-----|-----|-------|-------|----|
| 388-2424LC-CR-GGC | \$918   | \$1,047 | 95  | 2.4 | 23.75 | 23.75 | 42 |
| 388-2430LC-CR-GGC | \$918   | \$1,047 | 95  | 2.4 | 29.5  | 23.75 | 42 |
| 388-2436LC-CR-GGC | \$971   | \$1,107 | 102 | 3   | 35.5  | 23.75 | 42 |
| 388-2442LC-CR-GGC | \$1,006 | \$1,147 | 111 | 3.3 | 41.5  | 23.75 | 42 |
| 388-2448LC-CR-GGC | \$1,054 | \$1,202 | 120 | 3.8 | 47.25 | 23.75 | 42 |
| 388-2454LC-CR-GGC | \$1,096 | \$1,249 | 129 | 4.2 | 53.25 | 23.75 | 42 |
| 388-2460LC-CR-GGC | \$1,117 | \$1,273 | 138 | 4.7 | 59.25 | 23.75 | 42 |

W/ FULL LEFT GABLE, TALL BACK, RIGHT CONNECTING GABLE

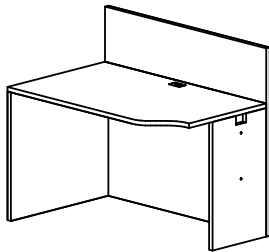

|                   |         |         |     |     |       |       |    |
|-------------------|---------|---------|-----|-----|-------|-------|----|
| 388-2424LC-CR-AGC | \$856   | \$976   | 80  | 2   | 23.75 | 23.75 | 42 |
| 388-2430LC-CR-AGC | \$856   | \$976   | 88  | 2.2 | 29.5  | 23.75 | 42 |
| 388-2436LC-CR-AGC | \$905   | \$1,032 | 95  | 2.8 | 35.5  | 23.75 | 42 |
| 388-2442LC-CR-AGC | \$939   | \$1,070 | 104 | 3.1 | 41.5  | 23.75 | 42 |
| 388-2448LC-CR-AGC | \$983   | \$1,121 | 112 | 3.5 | 47.25 | 23.75 | 42 |
| 388-2454LC-CR-AGC | \$1,022 | \$1,165 | 120 | 3.9 | 53.25 | 23.75 | 42 |
| 388-2460LC-CR-AGC | \$1,044 | \$1,190 | 129 | 4.3 | 59.25 | 23.75 | 42 |

W/ TALL LEFT GABLE, FULL MP, RIGHT CONNECTING GABLE

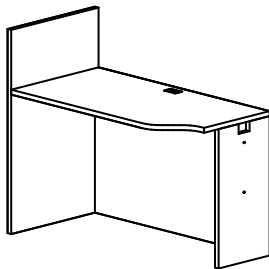

|                   |         |         |     |     |       |       |    |
|-------------------|---------|---------|-----|-----|-------|-------|----|
| 388-2448LC-CR-GMC | \$983   | \$1,121 | 112 | 3.5 | 47.25 | 23.75 | 42 |
| 388-2454LC-CR-GMC | \$1,022 | \$1,165 | 120 | 3.9 | 53.25 | 23.75 | 42 |
| 388-2460LC-CR-GMC | \$1,044 | \$1,190 | 129 | 4.3 | 59.25 | 23.75 | 42 |

| MODEL | LIST     | LIST      | WEIGHT | CUBE            | W  | D  | H  |
|-------|----------|-----------|--------|-----------------|----|----|----|
|       | 388 (1") | 600 (1½") | LBS    | FT <sup>3</sup> | IN | IN | IN |

**30" FREESTANDING GALLERY DESK**

W/ TALL BACK & GABLES

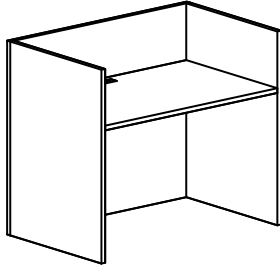

|                |         |         |     |     |       |      |    |
|----------------|---------|---------|-----|-----|-------|------|----|
| 388-3036CT-GGG | \$1,093 | \$1,246 | 135 | 3.8 | 35.5  | 29.5 | 42 |
| 388-3042CT-GGG | \$1,136 | \$1,295 | 145 | 4.5 | 41.5  | 29.5 | 42 |
| 388-3048CT-GGG | \$1,174 | \$1,338 | 156 | 5.2 | 47.25 | 29.5 | 42 |
| 388-3054CT-GGG | \$1,251 | \$1,426 | 166 | 5.9 | 53.25 | 29.5 | 42 |
| 388-3060CT-GGG | \$1,288 | \$1,468 | 176 | 6.7 | 59.25 | 29.5 | 42 |
| 388-3066CT-GGG | \$1,339 | \$1,526 | 187 | 7.5 | 65    | 29.5 | 42 |
| 388-3072CT-GGG | \$1,405 | \$1,602 | 197 | 8.3 | 71    | 29.5 | 42 |

W/ TALL LEFT GABLE & BACK, FULL RIGHT GABLE

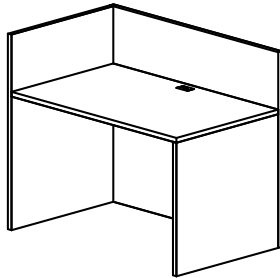

|                |         |         |     |     |       |      |    |
|----------------|---------|---------|-----|-----|-------|------|----|
| 388-3048CT-GGA | \$1,100 | \$1,254 | 145 | 4.5 | 47.25 | 29.5 | 42 |
| 388-3054CT-GGA | \$1,171 | \$1,335 | 155 | 5.2 | 53.25 | 29.5 | 42 |
| 388-3060CT-GGA | \$1,205 | \$1,374 | 165 | 6.3 | 59.25 | 29.5 | 42 |
| 388-3066CT-GGA | \$1,256 | \$1,432 | 176 | 7.5 | 65    | 29.5 | 42 |
| 388-3072CT-GGA | \$1,318 | \$1,503 | 185 | 8.3 | 71    | 29.5 | 42 |

W/ FULL LEFT GABLE, TALL BACK & RIGHT GABLE

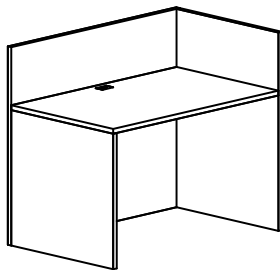

|                |         |         |     |     |       |      |    |
|----------------|---------|---------|-----|-----|-------|------|----|
| 388-3048CT-AGG | \$1,100 | \$1,254 | 145 | 4.5 | 47.25 | 29.5 | 42 |
| 388-3054CT-AGG | \$1,171 | \$1,335 | 155 | 5.2 | 53.25 | 29.5 | 42 |
| 388-3060CT-AGG | \$1,205 | \$1,374 | 165 | 6.3 | 59.25 | 29.5 | 42 |
| 388-3066CT-AGG | \$1,256 | \$1,432 | 176 | 7.5 | 65    | 29.5 | 42 |
| 388-3072CT-AGG | \$1,318 | \$1,503 | 185 | 8.3 | 71    | 29.5 | 42 |

W/ FULL LEFT GABLE, TALL BACK, FULL RIGHT GABLE

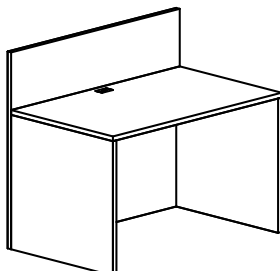

|                |         |         |     |     |       |      |    |
|----------------|---------|---------|-----|-----|-------|------|----|
| 388-3036CT-AGA | \$955   | \$1,089 | 119 | 3.5 | 35.5  | 29.5 | 42 |
| 388-3042CT-AGA | \$994   | \$1,133 | 129 | 4.2 | 41.5  | 29.5 | 42 |
| 388-3048CT-AGA | \$1,028 | \$1,172 | 136 | 5   | 47.25 | 29.5 | 42 |
| 388-3054CT-AGA | \$1,094 | \$1,247 | 147 | 5.5 | 53.25 | 29.5 | 42 |
| 388-3060CT-AGA | \$1,128 | \$1,286 | 157 | 6   | 59.25 | 29.5 | 42 |
| 388-3066CT-AGA | \$1,173 | \$1,337 | 164 | 6.6 | 65    | 29.5 | 42 |
| 388-3072CT-AGA | \$1,231 | \$1,403 | 172 | 7.3 | 71    | 29.5 | 42 |

RTA

**RECEPTION SERIES DESKS & CONNECTORS- 30"**  
**FREESTANDING LAMINATE GALLERY DESKS**

| MODEL | LIST     | LIST      | WEIGHT | CUBE            | W  | D  | H  |
|-------|----------|-----------|--------|-----------------|----|----|----|
|       | 388 (1") | 600 (1½") | LBS    | FT <sup>3</sup> | IN | IN | IN |

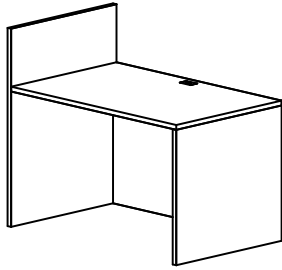

**30" FREESTANDING GALLERY DESK**

W/ TALL LEFT GABLE, FULL MP, FULL RIGHT GABLE

|                |         |         |     |     |       |      |    |
|----------------|---------|---------|-----|-----|-------|------|----|
| 388-3048CT-GMA | \$1,028 | \$1,172 | 136 | 4.5 | 47.25 | 29.5 | 42 |
| 388-3054CT-GMA | \$1,094 | \$1,247 | 147 | 5   | 53.25 | 29.5 | 42 |
| 388-3060CT-GMA | \$1,128 | \$1,286 | 157 | 6   | 59.25 | 29.5 | 42 |
| 388-3066CT-GMA | \$1,173 | \$1,337 | 164 | 6.6 | 65    | 29.5 | 42 |
| 388-3072CT-GMA | \$1,231 | \$1,403 | 172 | 7.3 | 71    | 29.5 | 42 |

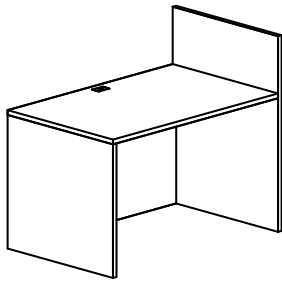

W/ FULL LEFT GABLE, FULL MP, TALL RIGHT GABLE

|                |         |         |     |     |       |      |    |
|----------------|---------|---------|-----|-----|-------|------|----|
| 388-3048CT-AMG | \$1,028 | \$1,172 | 136 | 4.5 | 47.25 | 29.5 | 42 |
| 388-3054CT-AMG | \$1,094 | \$1,247 | 147 | 5   | 53.25 | 29.5 | 42 |
| 388-3060CT-AMG | \$1,128 | \$1,286 | 157 | 6   | 59.25 | 29.5 | 42 |
| 388-3066CT-AMG | \$1,173 | \$1,337 | 164 | 6.6 | 65    | 29.5 | 42 |
| 388-3072CT-AMG | \$1,231 | \$1,403 | 172 | 7.3 | 71    | 29.5 | 42 |

**LEFT/RIGHT GALLERY CONNECTORS**

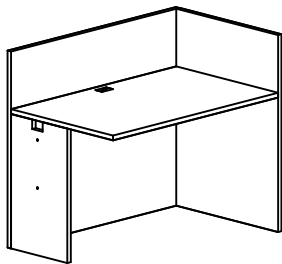

**GALLERY CONNECTORS- RIGHT HAND**

W/ LEFT CONNECTING GABLE, TALL BACK & RIGHT GABLE

|                |         |         |     |     |       |      |    |
|----------------|---------|---------|-----|-----|-------|------|----|
| 388-3030CT-CGG | \$971   | \$1,107 | 98  | 2   | 29.5  | 29.5 | 42 |
| 388-3036CT-CGG | \$1,025 | \$1,169 | 126 | 3.2 | 35.5  | 29.5 | 42 |
| 388-3042CT-CGG | \$1,064 | \$1,213 | 137 | 4.2 | 41.5  | 29.5 | 42 |
| 388-3048CT-CGG | \$1,100 | \$1,254 | 142 | 5   | 47.25 | 29.5 | 42 |
| 388-3054CT-CGG | \$1,171 | \$1,335 | 155 | 6   | 53.25 | 29.5 | 42 |
| 388-3060CT-CGG | \$1,205 | \$1,374 | 165 | 6.3 | 59.25 | 29.5 | 42 |

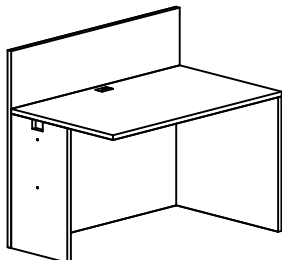

W/ LEFT CONNECTING GABLE, TALL BACK, FULL RIGHT GABLE

|                |         |         |     |     |       |      |    |
|----------------|---------|---------|-----|-----|-------|------|----|
| 388-3030CT-CGA | \$905   | \$1,032 | 95  | 2   | 29.5  | 29.5 | 42 |
| 388-3036CT-CGA | \$955   | \$1,089 | 119 | 3.5 | 35.5  | 29.5 | 42 |
| 388-3042CT-CGA | \$994   | \$1,133 | 129 | 4.2 | 41.5  | 29.5 | 42 |
| 388-3048CT-CGA | \$1,028 | \$1,172 | 136 | 5   | 47.25 | 29.5 | 42 |
| 388-3054CT-CGA | \$1,094 | \$1,247 | 147 | 5.5 | 53.25 | 29.5 | 42 |
| 388-3060CT-CGA | \$1,128 | \$1,286 | 157 | 6   | 59.25 | 29.5 | 42 |

**RTA**

| MODEL | LIST     | LIST      | WEIGHT | CUBE            | W  | D  | H  |
|-------|----------|-----------|--------|-----------------|----|----|----|
|       | 388 (1") | 600 (1½") | LBS    | FT <sup>3</sup> | IN | IN | IN |

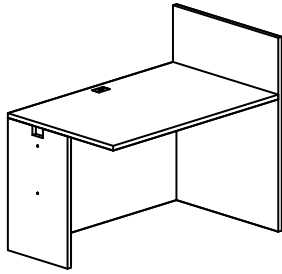

**GALLERY CONNECTORS- RIGHT HAND**

W/ LEFT CONNECTING GABLE, FULL MP, TALL RIGHT GABLE

|                |         |         |     |     |       |      |    |
|----------------|---------|---------|-----|-----|-------|------|----|
| 388-3048CT-CMG | \$1,028 | \$1,172 | 136 | 4.5 | 47.25 | 29.5 | 42 |
| 388-3054CT-CMG | \$1,094 | \$1,247 | 147 | 5   | 53.25 | 29.5 | 42 |
| 388-3060CT-CMG | \$1,128 | \$1,286 | 157 | 6   | 59.25 | 29.5 | 42 |

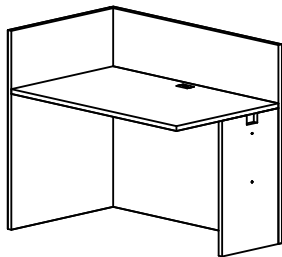

**GALLERY CONNECTORS- LEFT HAND**

W/ TALL BACK & LEFT GABLE, RIGHT CONNECTING GABLE

|                |         |         |     |     |       |      |    |
|----------------|---------|---------|-----|-----|-------|------|----|
| 388-3030CT-GGC | \$971   | \$1,107 | 98  | 2   | 29.5  | 29.5 | 42 |
| 388-3036CT-GGC | \$1,025 | \$1,169 | 126 | 3.2 | 35.5  | 29.5 | 42 |
| 388-3042CT-GGC | \$1,064 | \$1,213 | 137 | 4.2 | 41.5  | 29.5 | 42 |
| 388-3048CT-GGC | \$1,100 | \$1,254 | 142 | 5   | 47.25 | 29.5 | 42 |
| 388-3054CT-GGC | \$1,171 | \$1,335 | 155 | 6   | 53.25 | 29.5 | 42 |
| 388-3060CT-GGC | \$1,205 | \$1,374 | 165 | 6.3 | 59.25 | 29.5 | 42 |

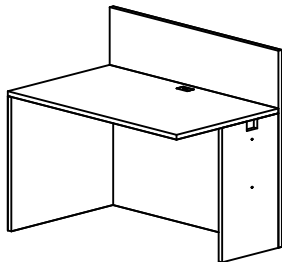

W/ FULL LEFT GABLE, TALL BACK, RIGHT CONNECTING GABLE

|                |         |         |     |     |       |      |    |
|----------------|---------|---------|-----|-----|-------|------|----|
| 388-3030CT-AGC | \$905   | \$1,032 | 95  | 2   | 29.5  | 29.5 | 42 |
| 388-3036CT-AGC | \$955   | \$1,089 | 119 | 3.5 | 35.5  | 29.5 | 42 |
| 388-3042CT-AGC | \$994   | \$1,133 | 129 | 4.2 | 41.5  | 29.5 | 42 |
| 388-3048CT-AGC | \$1,028 | \$1,172 | 136 | 5   | 47.25 | 29.5 | 42 |
| 388-3054CT-AGC | \$1,094 | \$1,247 | 147 | 5.5 | 53.25 | 29.5 | 42 |
| 388-3060CT-AGC | \$1,128 | \$1,286 | 157 | 6   | 59.25 | 29.5 | 42 |

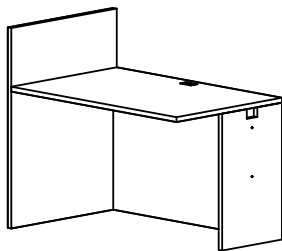

W/ TALL LEFT GABLE, FULL MP, RIGHT CONNECTING GABLE

|                |         |         |     |     |       |      |    |
|----------------|---------|---------|-----|-----|-------|------|----|
| 388-3048CT-GMC | \$1,028 | \$1,172 | 136 | 4.5 | 47.25 | 29.5 | 42 |
| 388-3054CT-GMC | \$1,094 | \$1,247 | 147 | 5   | 53.25 | 29.5 | 42 |
| 388-3060CT-GMC | \$1,128 | \$1,286 | 157 | 6   | 59.25 | 29.5 | 42 |

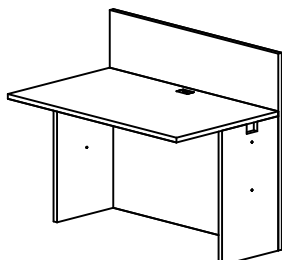

**GALLERY CONNECTOR**

W/ LEFT CONNECTING GABLE, TALL BACK, RIGHT CONNECTING GABLE

|                |         |         |     |     |       |      |    |
|----------------|---------|---------|-----|-----|-------|------|----|
| 388-3036CT-CGC | \$955   | \$1,089 | 119 | 3.5 | 35.5  | 29.5 | 42 |
| 388-3042CT-CGC | \$994   | \$1,133 | 129 | 4.2 | 41.5  | 29.5 | 42 |
| 388-3048CT-CGC | \$1,028 | \$1,172 | 136 | 5   | 47.25 | 29.5 | 42 |
| 388-3054CT-CGC | \$1,094 | \$1,247 | 144 | 5.6 | 53.25 | 29.5 | 42 |
| 388-3060CT-CGC | \$1,128 | \$1,286 | 157 | 6   | 59.25 | 29.5 | 42 |

RTA

**RECEPTION SERIES DESKS & CONNECTORS- 30"**  
**CUTBACK LAMINATE GALLERY CONNECTORS**

| MODEL | LIST     | LIST      | WEIGHT | CUBE            | W  | D  | H  |
|-------|----------|-----------|--------|-----------------|----|----|----|
|       | 388 (1") | 600 (1½") | LBS    | FT <sup>3</sup> | IN | IN | IN |

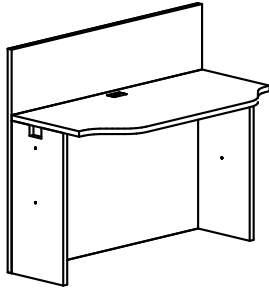

**CUTBACK GALLERY CONNECTOR**

W/ LEFT CONNECTING GABLE, TALL BACK, RIGHT CONNECTING GABLE

|                   |         |         |     |     |       |      |    |
|-------------------|---------|---------|-----|-----|-------|------|----|
| 388-3042CC-CD-CGC | \$965   | \$1,100 | 129 | 4.2 | 41.5  | 29.5 | 42 |
| 388-3048CC-CD-CGC | \$1,010 | \$1,151 | 136 | 5   | 47.25 | 29.5 | 42 |
| 388-3054CC-CD-CGC | \$1,070 | \$1,220 | 144 | 5.6 | 53.25 | 29.5 | 42 |
| 388-3060CC-CD-CGC | \$1,079 | \$1,230 | 157 | 6   | 59.25 | 29.5 | 42 |

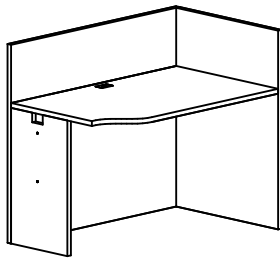

**CUTBACK GALLERY CONNECTOR- RIGHT HAND**

W/ LEFT CONNECTING GABLE, TALL BACK & RIGHT GABLE

|                   |         |         |     |     |       |      |    |
|-------------------|---------|---------|-----|-----|-------|------|----|
| 388-3030RC-CL-CGG | \$1,025 | \$1,169 | 117 | 2.7 | 29.5  | 29.5 | 42 |
| 388-3036RC-CL-CGG | \$1,076 | \$1,227 | 106 | 3   | 35.5  | 29.5 | 42 |
| 388-3042RC-CL-CGG | \$1,117 | \$1,273 | 137 | 4.2 | 41.5  | 29.5 | 42 |
| 388-3048RC-CL-CGG | \$1,149 | \$1,310 | 146 | 5.4 | 47.25 | 29.5 | 42 |
| 388-3054RC-CL-CGG | \$1,221 | \$1,392 | 155 | 6   | 53.25 | 29.5 | 42 |
| 388-3060RC-CL-CGG | \$1,254 | \$1,430 | 155 | 6   | 59.25 | 29.5 | 42 |

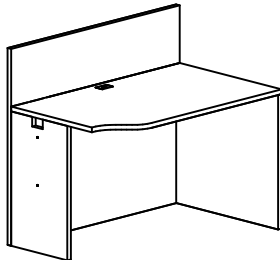

W/ LEFT CONNECTING GABLE, TALL BACK, FULL RIGHT GABLE

|                   |         |         |     |     |       |      |    |
|-------------------|---------|---------|-----|-----|-------|------|----|
| 388-3030RC-CL-CGA | \$955   | \$1,089 | 109 | 2.5 | 29.5  | 29.5 | 42 |
| 388-3036RC-CL-CGA | \$1,004 | \$1,145 | 119 | 3.5 | 35.5  | 29.5 | 42 |
| 388-3042RC-CL-CGA | \$1,044 | \$1,190 | 127 | 3.9 | 41.5  | 29.5 | 42 |
| 388-3048RC-CL-CGA | \$1,074 | \$1,224 | 146 | 5   | 47.25 | 29.5 | 42 |
| 388-3054RC-CL-CGA | \$1,141 | \$1,301 | 164 | 5.5 | 53.25 | 29.5 | 42 |
| 388-3060RC-CL-CGA | \$1,170 | \$1,334 | 201 | 6   | 59.25 | 29.5 | 42 |

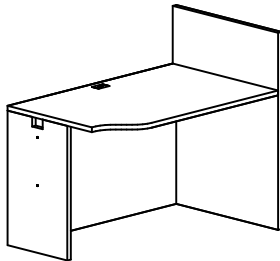

W/ LEFT CONNECTING GABLE, FULL MP, TALL RIGHT GABLE

|                   |         |         |     |     |       |      |    |
|-------------------|---------|---------|-----|-----|-------|------|----|
| 388-3048RC-CL-CMG | \$1,074 | \$1,224 | 136 | 4.5 | 47.25 | 29.5 | 42 |
| 388-3054RC-CL-CMG | \$1,141 | \$1,301 | 147 | 5   | 53.25 | 29.5 | 42 |
| 388-3060RC-CL-CMG | \$1,170 | \$1,334 | 157 | 6   | 59.25 | 29.5 | 42 |

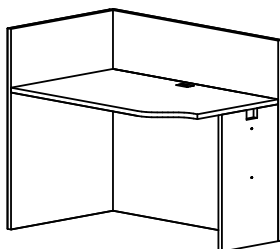

**CUTBACK GALLERY CONNECTOR- LEFT HAND**

W/ RIGHT CONNECTING GABLE, TALL LEFT GABLE & BACK

|                   |         |         |     |     |       |      |    |
|-------------------|---------|---------|-----|-----|-------|------|----|
| 388-3030LC-CR-GGC | \$1,025 | \$1,169 | 117 | 2.7 | 29.5  | 29.5 | 42 |
| 388-3036LC-CR-GGC | \$1,076 | \$1,227 | 106 | 3   | 35.5  | 29.5 | 42 |
| 388-3042LC-CR-GGC | \$1,117 | \$1,273 | 137 | 4.2 | 41.5  | 29.5 | 42 |
| 388-3048LC-CR-GGC | \$1,149 | \$1,310 | 146 | 5.4 | 47.25 | 29.5 | 42 |
| 388-3054LC-CR-GGC | \$1,221 | \$1,392 | 155 | 6   | 53.25 | 29.5 | 42 |
| 388-3060LC-CR-GGC | \$1,254 | \$1,430 | 155 | 6   | 59.25 | 29.5 | 42 |

**RTA**

| MODEL | LIST     | LIST      | WEIGHT | CUBE            | W  | D  | H  |
|-------|----------|-----------|--------|-----------------|----|----|----|
|       | 388 (1") | 600 (1½") | LBS    | FT <sup>3</sup> | IN | IN | IN |

**CUTBACK GALLERY CONNECTOR- LEFT HAND**

W/ FULL LEFT GABLE, TALL BACK, RIGHT CONNECTING GABLE

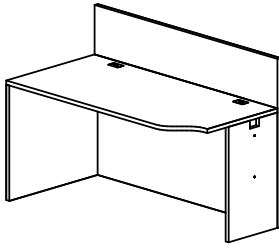

|                   |         |         |     |     |       |      |    |
|-------------------|---------|---------|-----|-----|-------|------|----|
| 388-3030LC-CR-AGC | \$955   | \$1,089 | 109 | 2.5 | 29.5  | 29.5 | 42 |
| 388-3036LC-CR-AGC | \$1,004 | \$1,145 | 106 | 3   | 35.5  | 29.5 | 42 |
| 388-3042LC-CR-AGC | \$1,044 | \$1,190 | 127 | 3.9 | 41.5  | 29.5 | 42 |
| 388-3048LC-CR-AGC | \$1,074 | \$1,224 | 97  | 4   | 47.25 | 29.5 | 42 |
| 388-3054LC-CR-AGC | \$1,141 | \$1,301 | 164 | 6.6 | 53.25 | 29.5 | 42 |
| 388-3060LC-CR-AGC | \$1,170 | \$1,334 | 201 | 4.5 | 59.25 | 29.5 | 42 |

W/ TALL LEFT GABLE, FULL MP, RIGHT CONNECTING GABLE

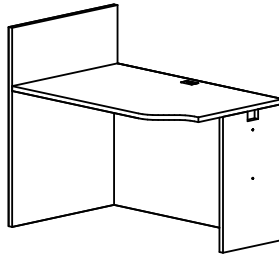

|                   |         |         |     |     |       |      |    |
|-------------------|---------|---------|-----|-----|-------|------|----|
| 388-3048LC-CR-GMC | \$1,074 | \$1,224 | 136 | 4.5 | 47.25 | 29.5 | 42 |
| 388-3054LC-CR-GMC | \$1,141 | \$1,301 | 147 | 5   | 53.25 | 29.5 | 42 |
| 388-3060LC-CR-GMC | \$1,170 | \$1,334 | 157 | 6   | 59.25 | 29.5 | 42 |

RTA

# RECEPTION SERIES CORNER MODULES

## STANDARD LAMINATE GALLERY CORNER MODULES- 18, 24 & 30"

| MODEL | LIST     | LIST         | WEIGHT | CUBE            | W  | D  | H  |
|-------|----------|--------------|--------|-----------------|----|----|----|
|       | 388 (1") | 600 (1 1/2") | LBS    | FT <sup>3</sup> | IN | IN | IN |

### GALLERY CORNER MODULE

W/ 2 TALL BACKS, 2 CONNECTING GABLES

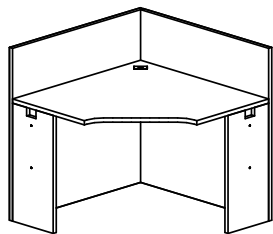

|                        |                |                |            |             |              |              |           |
|------------------------|----------------|----------------|------------|-------------|--------------|--------------|-----------|
| <b>388-1836CM-CGGC</b> | <b>\$1,232</b> | <b>\$1,404</b> | <b>138</b> | <b>6.8</b>  | <b>35.5</b>  | <b>35.5</b>  | <b>42</b> |
| <b>388-2436CM-CGGC</b> | <b>\$1,244</b> | <b>\$1,418</b> | <b>144</b> | <b>6.8</b>  | <b>35.5</b>  | <b>35.5</b>  | <b>42</b> |
| <b>388-2442CM-CGGC</b> | <b>\$1,458</b> | <b>\$1,662</b> | <b>153</b> | <b>8.7</b>  | <b>41.5</b>  | <b>41.5</b>  | <b>42</b> |
| <b>388-3042CM-CGGC</b> | <b>\$1,471</b> | <b>\$1,677</b> | <b>155</b> | <b>8.7</b>  | <b>41.5</b>  | <b>41.5</b>  | <b>42</b> |
| <b>388-3048CM-CGGC</b> | <b>\$1,556</b> | <b>\$1,774</b> | <b>210</b> | <b>10.5</b> | <b>47.25</b> | <b>47.25</b> | <b>42</b> |

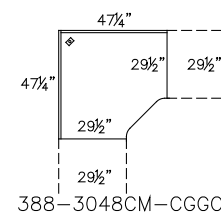
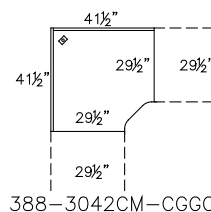
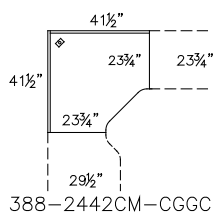
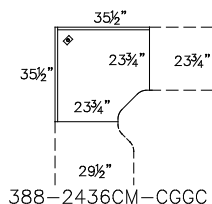
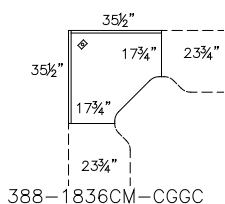

W/ TALL LEFT BACK, 2 CONNECTING GABLES, FULL RIGHT MP

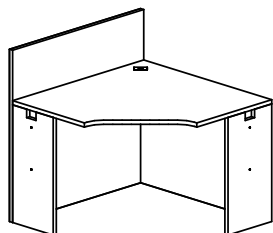

|                        |                |                |            |            |              |              |           |
|------------------------|----------------|----------------|------------|------------|--------------|--------------|-----------|
| <b>388-1836CM-CGMC</b> | <b>\$1,149</b> | <b>\$1,310</b> | <b>129</b> | <b>6.3</b> | <b>35.5</b>  | <b>35.5</b>  | <b>42</b> |
| <b>388-2436CM-CGMC</b> | <b>\$1,162</b> | <b>\$1,325</b> | <b>135</b> | <b>6.3</b> | <b>35.5</b>  | <b>35.5</b>  | <b>42</b> |
| <b>388-2442CM-CGMC</b> | <b>\$1,361</b> | <b>\$1,552</b> | <b>143</b> | <b>8.2</b> | <b>41.5</b>  | <b>41.5</b>  | <b>42</b> |
| <b>388-3042CM-CGMC</b> | <b>\$1,373</b> | <b>\$1,565</b> | <b>145</b> | <b>8.2</b> | <b>41.5</b>  | <b>41.5</b>  | <b>42</b> |
| <b>388-3048CM-CGMC</b> | <b>\$1,452</b> | <b>\$1,655</b> | <b>196</b> | <b>9.8</b> | <b>47.25</b> | <b>47.25</b> | <b>42</b> |

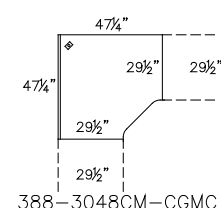
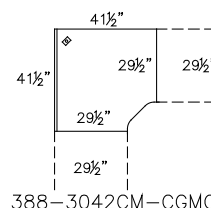
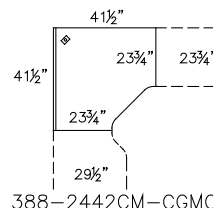
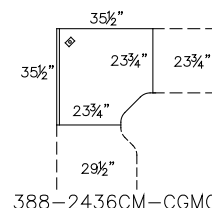
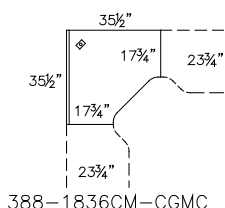

W/ TALL RIGHT BACK, 2 CONNECTING GABLES, FULL LEFT MP

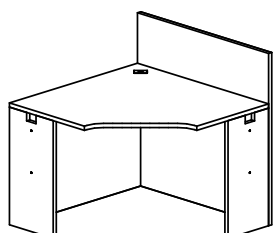

|                        |                |                |            |            |              |              |           |
|------------------------|----------------|----------------|------------|------------|--------------|--------------|-----------|
| <b>388-1836CM-CMGC</b> | <b>\$1,149</b> | <b>\$1,310</b> | <b>129</b> | <b>6.3</b> | <b>35.5</b>  | <b>35.5</b>  | <b>42</b> |
| <b>388-2436CM-CMGC</b> | <b>\$1,162</b> | <b>\$1,325</b> | <b>135</b> | <b>6.3</b> | <b>35.5</b>  | <b>35.5</b>  | <b>42</b> |
| <b>388-2442CM-CMGC</b> | <b>\$1,361</b> | <b>\$1,552</b> | <b>143</b> | <b>8.2</b> | <b>41.5</b>  | <b>41.5</b>  | <b>42</b> |
| <b>388-3042CM-CMGC</b> | <b>\$1,373</b> | <b>\$1,565</b> | <b>145</b> | <b>8.2</b> | <b>41.5</b>  | <b>41.5</b>  | <b>42</b> |
| <b>388-3048CM-CMGC</b> | <b>\$1,452</b> | <b>\$1,655</b> | <b>196</b> | <b>9.8</b> | <b>47.25</b> | <b>47.25</b> | <b>42</b> |

**RTA**

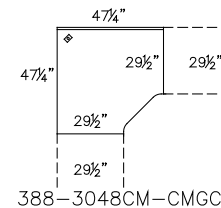
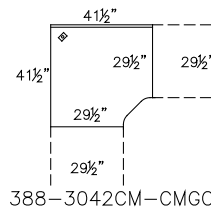
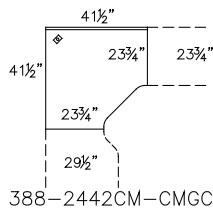
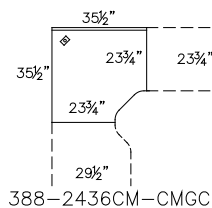
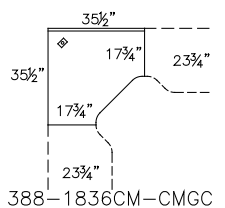



| MODEL | LIST     | LIST      | WEIGHT | CUBE            | W  | D  | H  |
|-------|----------|-----------|--------|-----------------|----|----|----|
|       | 388 (1") | 600 (1½") | LBS    | FT <sup>3</sup> | IN | IN | IN |

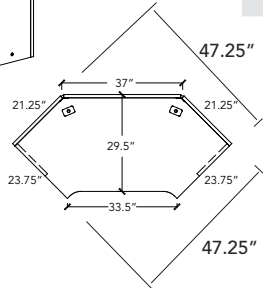
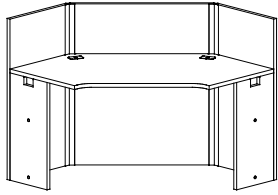

**GALLERY NEO-ANGLE CORNER MODULE**

24" ENDS

|                      |                |                |            |            |              |              |           |
|----------------------|----------------|----------------|------------|------------|--------------|--------------|-----------|
| <b>388-G2448NACM</b> | <b>\$2,119</b> | <b>\$2,416</b> | <b>146</b> | <b>6.1</b> | <b>47.25</b> | <b>47.25</b> | <b>42</b> |
|----------------------|----------------|----------------|------------|------------|--------------|--------------|-----------|

**NEO-ANGLE LAMINATE GALLERY CORNER WEDGES**

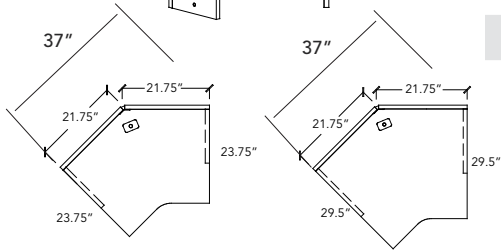
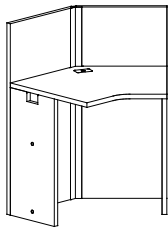

**GALLERY NEO-ANGLE CORNER WEDGE**

24" ENDS

|                      |                |                |           |            |           |              |           |
|----------------------|----------------|----------------|-----------|------------|-----------|--------------|-----------|
| <b>388-G2424NACW</b> | <b>\$1,341</b> | <b>\$1,529</b> | <b>81</b> | <b>3.6</b> | <b>37</b> | <b>23.75</b> | <b>42</b> |
|----------------------|----------------|----------------|-----------|------------|-----------|--------------|-----------|

30" ENDS

|                      |                |                |            |            |           |             |           |
|----------------------|----------------|----------------|------------|------------|-----------|-------------|-----------|
| <b>388-G3030NACW</b> | <b>\$1,588</b> | <b>\$1,810</b> | <b>103</b> | <b>4.1</b> | <b>37</b> | <b>29.5</b> | <b>42</b> |
|----------------------|----------------|----------------|------------|------------|-----------|-------------|-----------|

**NEO-ANGLE LAMINATE GALLERY TRANSACTION TOP**

| MODEL | LIST     | LIST      | WEIGHT | CUBE            | W  | D  | H   | H    |
|-------|----------|-----------|--------|-----------------|----|----|-----|------|
|       | 388 (1") | 600 (1½") | LBS    | FT <sup>3</sup> | IN | IN | 1IN | 1½IN |

**NEO-ANGLE GALLERY TRANSACTION TOP**

FITS 388-G2448NACM & INCLUDES ANGLE SUPPORT BRACKETS & SCREWS

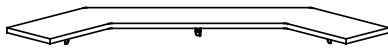

|                     |              |              |           |          |            |           |          |            |
|---------------------|--------------|--------------|-----------|----------|------------|-----------|----------|------------|
| <b>388-1248NAGT</b> | <b>\$513</b> | <b>\$585</b> | <b>35</b> | <b>1</b> | <b>N/A</b> | <b>12</b> | <b>1</b> | <b>1.5</b> |
|---------------------|--------------|--------------|-----------|----------|------------|-----------|----------|------------|

**NEO-ANGLE LAMINATE GALLERY WEDGE TRANSACTION TOPS**

**NEO-ANGLE GALLERY WEDGE TRANSACTION TOP**

FITS 388-G2424NACW & INCLUDES ANGLE SUPPORT BRACKETS & SCREWS

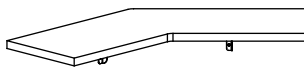

|                      |              |              |           |            |            |           |          |            |
|----------------------|--------------|--------------|-----------|------------|------------|-----------|----------|------------|
| <b>388-1224NAGTW</b> | <b>\$377</b> | <b>\$430</b> | <b>18</b> | <b>0.8</b> | <b>N/A</b> | <b>12</b> | <b>1</b> | <b>1.5</b> |
|----------------------|--------------|--------------|-----------|------------|------------|-----------|----------|------------|

FITS 388-G3030NACW & INCLUDES ANGLE SUPPORT BRACKETS & SCREWS

|                      |              |              |           |            |            |           |          |            |
|----------------------|--------------|--------------|-----------|------------|------------|-----------|----------|------------|
| <b>388-1230NAGTW</b> | <b>\$402</b> | <b>\$458</b> | <b>20</b> | <b>0.8</b> | <b>N/A</b> | <b>12</b> | <b>1</b> | <b>1.5</b> |
|----------------------|--------------|--------------|-----------|------------|------------|-----------|----------|------------|

## RECEPTION SERIES TOPS BOW FRONT LAMINATE GALLERY TOPS

| MODEL | LIST     | LIST      | WEIGHT | CUBE            | W  | D  | H   | H    |
|-------|----------|-----------|--------|-----------------|----|----|-----|------|
|       | 388 (1") | 600 (1½") | LBS    | FT <sup>3</sup> | IN | IN | 1IN | 1½IN |

### BOW FRONT GALLERY TOP

USE NEXT SIZE UP PRICE FOR INTERMEDIATE SIZES. MAX LENGTH AVAILABLE IS 96".

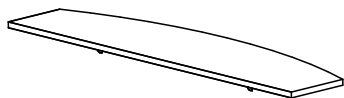

|             |       |       |    |   |       |       |   |     |
|-------------|-------|-------|----|---|-------|-------|---|-----|
| 388-B1260GT | \$447 | \$510 | 30 | 1 | 59.25 | 17.75 | 1 | 1.5 |
| 388-B1266GT | \$480 | \$547 | 35 | 1 | 65    | 17.75 | 1 | 1.5 |
| 388-B1272GT | \$501 | \$571 | 42 | 1 | 71    | 17.75 | 1 | 1.5 |
| 388-B1278GT | \$526 | \$600 | 48 | 1 | 77    | 17.75 | 1 | 1.5 |
| 388-B1284GT | \$543 | \$619 | 55 | 1 | 82.75 | 17.75 | 1 | 1.5 |

- INCLUDES ANGLE SUPPORT BRACKETS & SCREWS

### RADIUS CORNER INSERT

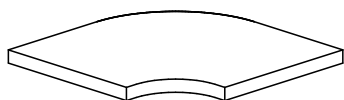

|                 |       |       |    |   |       |       |   |     |
|-----------------|-------|-------|----|---|-------|-------|---|-----|
| 388-17.517.5RCI | \$335 | \$382 | 12 | 1 | 17.25 | 17.25 | 1 | 1.5 |
|-----------------|-------|-------|----|---|-------|-------|---|-----|

- SEE PAGE [REC-5](#) FOR CORNER APPLICATION

## STRAIGHT LAMINATE GALLERY TOPS

### STRAIGHT TOP

USE NEXT SIZE UP PRICE FOR INTERMEDIATE SIZES. MAX LENGTH AVAILABLE IS 96".

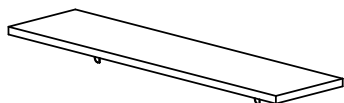

|            |       |       |    |   |       |    |   |     |
|------------|-------|-------|----|---|-------|----|---|-----|
| 388-1224GT | \$171 | \$195 | 10 | 1 | 23.75 | 12 | 1 | 1.5 |
| 388-1230GT | \$191 | \$218 | 12 | 1 | 29.5  | 12 | 1 | 1.5 |
| 388-1236GT | \$213 | \$243 | 15 | 1 | 35.5  | 12 | 1 | 1.5 |
| 388-1242GT | \$227 | \$259 | 18 | 1 | 41.5  | 12 | 1 | 1.5 |
| 388-1248GT | \$250 | \$285 | 20 | 1 | 47.25 | 12 | 1 | 1.5 |
| 388-1254GT | \$267 | \$304 | 25 | 1 | 53.25 | 12 | 1 | 1.5 |
| 388-1260GT | \$290 | \$331 | 30 | 1 | 59.25 | 12 | 1 | 1.5 |
| 388-1266GT | \$320 | \$365 | 35 | 1 | 65    | 12 | 1 | 1.5 |
| 388-1272GT | \$345 | \$393 | 42 | 1 | 71    | 12 | 1 | 1.5 |
| 388-1278GT | \$366 | \$417 | 48 | 1 | 77    | 12 | 1 | 1.5 |
| 388-1284GT | \$384 | \$438 | 55 | 1 | 82.75 | 12 | 1 | 1.5 |
| 388-1290GT | \$407 | \$464 | 60 | 1 | 88.75 | 12 | 1 | 1.5 |
| 388-1296GT | \$432 | \$492 | 66 | 1 | 94.5  | 12 | 1 | 1.5 |

- INCLUDES ANGLE SUPPORT BRACKETS & SCREWS

RTA

- ♥ Transaction top & front panels are high-pressure laminate (HP). See [Heartwood.ca](http://Heartwood.ca) for available high-pressure laminate matches or contact Customer Service
  - remaining parts are standard Heartwood laminate finishes
- ♥ Curved units have shelving below worksurface
- ♥ Curved units have exposed gables for 3D effect.
- ♥ Straight units have non-exposed gables, full width front panels.
- ♥ Front panels have horizontal grain
- ♥ Transaction tops are 3/4" thick laminate, worksurfaces are 1" thick

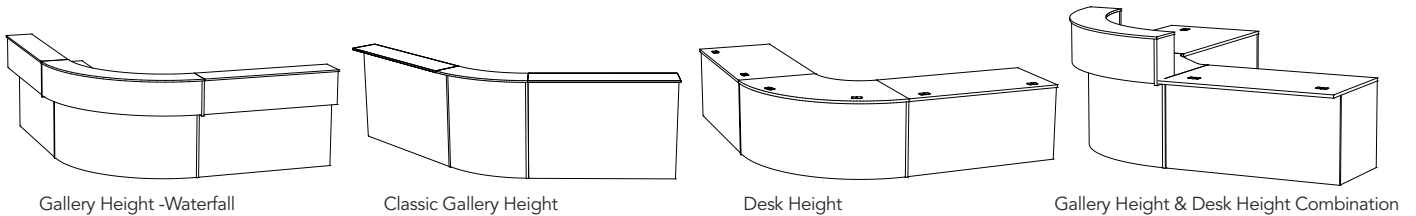

- ♥ Choice of gallery height waterfall design, classic gallery height or desk height.
- ♥ Height-adjustable gallery connectors are sized for Heartwood height-adjustable units, height-adjustable desk is not included. See [Height Adjustable Series](#)
- ♥ Curved units ship **Full Carton**
- RTA** RTA units ship Ready to Assembly.

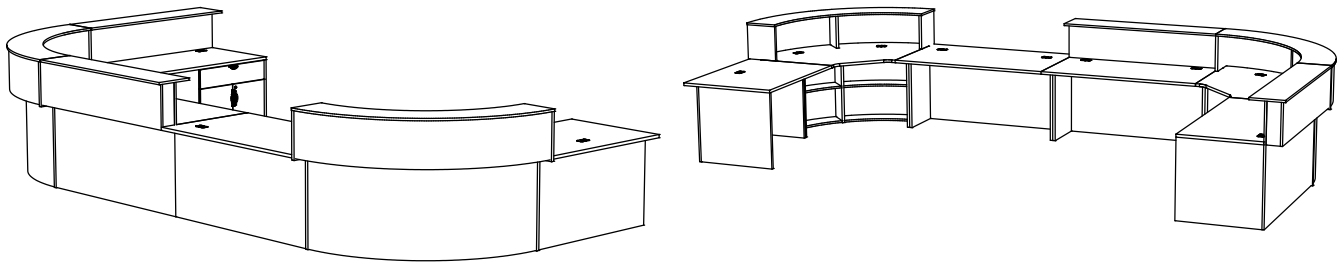

**EXAMPLE A**

|                         |           |   |
|-------------------------|-----------|---|
| <b>388-OH3648CT-ATC</b> |           | DESK HEIGHT CONNECTOR TOP WITH OVERHANG               |
| <b>388-3654MGCVCM</b>   | <b>X2</b> | GALLERY CURVED RECEPTION CORNER MODULE WITH WATERFALL |
| <b>388-OH3660CT-CTC</b> |           | DESK HEIGHT CONNECTOR TOP WITH OVERHANG               |
| <b>388-3660MGCT-CGC</b> | <b>X2</b> | GALLERY CONNECTOR WITH WATERFALL                      |
| <b>388-1930WDCX</b>     |           | CABINET - WIDE DRAWER OVER 2 DOOR CABINET - NO TOP    |

**RECEPTION SERIES**  
**CURVED WATERFALL CORNER MODULES**

| MODEL | LIST     | WEIGHT | CUBE            | W  | D  | H   |
|-------|----------|--------|-----------------|----|----|-----|
|       | 388 (1") | LBS    | FT <sup>3</sup> | IN | IN | 1IN |

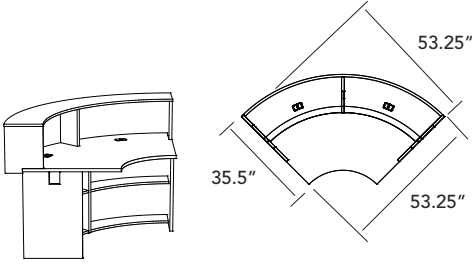

**GALLERY CURVED RECEPTION CORNER MODULE WITH WATERFALL**

RADIUS CORNER MODULE TOP

|                       |                |     |      |       |       |    |
|-----------------------|----------------|-----|------|-------|-------|----|
| <b>388-3654MGCVRM</b> | <b>\$4,689</b> | 190 | 77.6 | 53.25 | 53.25 | 43 |
|-----------------------|----------------|-----|------|-------|-------|----|

CORNER MODULE TOP

|                       |                |     |      |       |       |    |
|-----------------------|----------------|-----|------|-------|-------|----|
| <b>388-3654MGCVCM</b> | <b>\$4,689</b> | 190 | 77.6 | 53.25 | 53.25 | 43 |
|-----------------------|----------------|-----|------|-------|-------|----|

- TRANSACTION & FRONT PANELS ARE HIGH PRESSURE LAMINATE. SEE [HEARTWOOD.CA](http://HEARTWOOD.CA) FOR AVAILABLE HIGH-PRESSURE LAMINATE MATCHES OR CONTACT CUSTOMER SERVICE
- SHIPPED ASSEMBLED

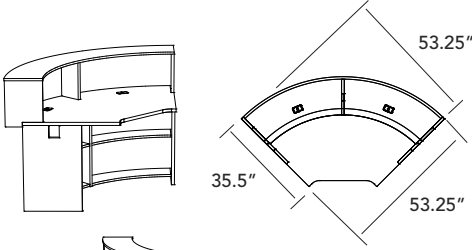

**GALLERY CURVED RECEPTION CORNER MODULE WEDGE WITH WATERFALL**

RADIUS CORNER MODULE TOP

|                       |                |     |      |      |      |    |
|-----------------------|----------------|-----|------|------|------|----|
| <b>388-3627MGCVRM</b> | <b>\$3,677</b> | 112 | 38.2 | 37.5 | 35.5 | 43 |
|-----------------------|----------------|-----|------|------|------|----|

- TRANSACTION & FRONT PANELS ARE HIGH PRESSURE LAMINATE. SEE [HEARTWOOD.CA](http://HEARTWOOD.CA) FOR AVAILABLE HIGH-PRESSURE LAMINATE MATCHES OR CONTACT CUSTOMER SERVICE
- SHIPPED ASSEMBLED

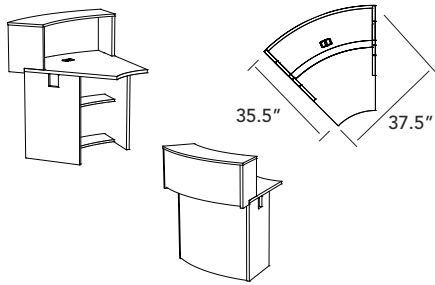

FULL CARTON

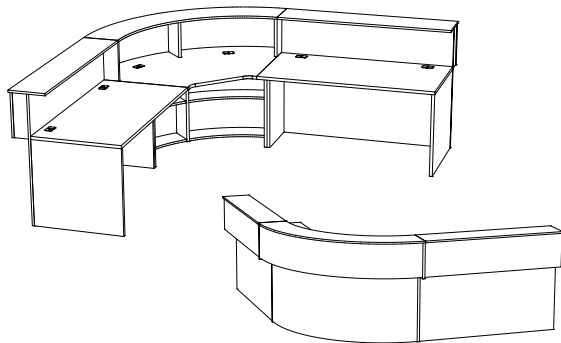

**EXAMPLE A**

|                         |   |
|-------------------------|---|
| <b>388-3660MGCT-AGC</b> | GALLERY CONNECTOR WITH WATERFALL                      |
| <b>388-3654MGCVCM</b>   | GALLERY CURVED RECEPTION CORNER MODULE WITH WATERFALL |
| <b>388-3660MGCT-CGA</b> | GALLERY CONNECTOR WITH WATERFALL                      |

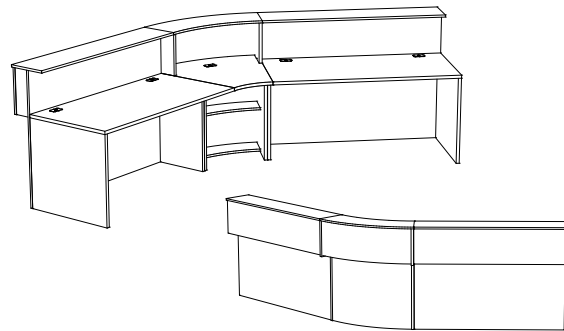

**EXAMPLE B**

|                         |   |
|-------------------------|---|
| <b>388-3660MGCT-AGC</b> | GALLERY CONNECTOR WITH WATERFALL                            |
| <b>388-3627MGCVRM</b>   | GALLERY CURVED RECEPTION CORNER MODULE WEDGE WITH WATERFALL |
| <b>388-3660MGCT-CGA</b> | GALLERY CONNECTOR WITH WATERFALL                            |

| MODEL | LIST     | WEIGHT | CUBE            | W  | D  | H   |
|-------|----------|--------|-----------------|----|----|-----|
|       | 388 (1") | LBS    | FT <sup>3</sup> | IN | IN | 1IN |

**GALLERY CURVED RECEPTION CORNER MODULE**

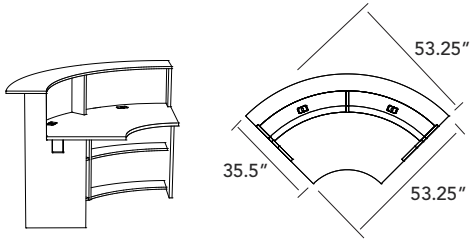

RADIUS CORNER MODULE TOP

|                       |                |            |             |              |              |           |
|-----------------------|----------------|------------|-------------|--------------|--------------|-----------|
| <b>388-3654GCVRCM</b> | <b>\$4,513</b> | <b>190</b> | <b>77.6</b> | <b>53.25</b> | <b>53.25</b> | <b>43</b> |
|-----------------------|----------------|------------|-------------|--------------|--------------|-----------|

CORNER MODULE TOP

|                      |                |            |             |              |              |           |
|----------------------|----------------|------------|-------------|--------------|--------------|-----------|
| <b>388-3654GCVCM</b> | <b>\$4,513</b> | <b>190</b> | <b>77.6</b> | <b>53.25</b> | <b>53.25</b> | <b>43</b> |
|----------------------|----------------|------------|-------------|--------------|--------------|-----------|

- TRANSACTION & FRONT PANELS ARE HIGH PRESSURE LAMINATE. SEE [HEARTWOOD.CA](http://HEARTWOOD.CA) FOR AVAILABLE HIGH-PRESSURE LAMINATE MATCHES OR CONTACT CUSTOMER SERVICE
- SHIPPED ASSEMBLED

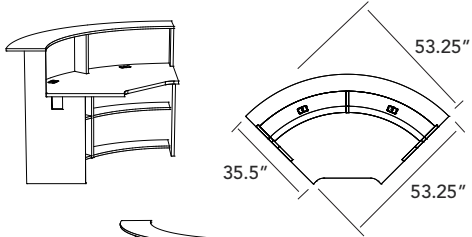

**GALLERY CURVED RECEPTION CORNER MODULE WEDGE**

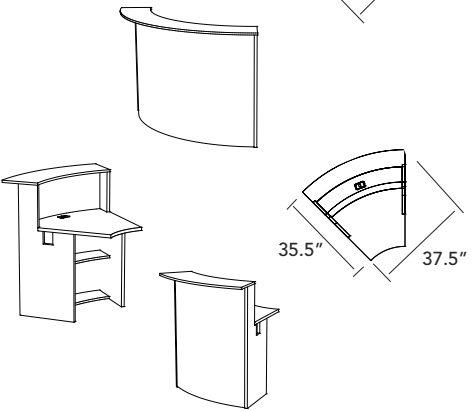

RADIUS CORNER MODULE TOP

|                       |                |            |             |             |             |           |
|-----------------------|----------------|------------|-------------|-------------|-------------|-----------|
| <b>388-3627GCVRCW</b> | <b>\$3,516</b> | <b>112</b> | <b>38.2</b> | <b>37.5</b> | <b>35.5</b> | <b>43</b> |
|-----------------------|----------------|------------|-------------|-------------|-------------|-----------|

- TRANSACTION & FRONT PANELS ARE HIGH PRESSURE LAMINATE. SEE [HEARTWOOD.CA](http://HEARTWOOD.CA) FOR AVAILABLE HIGH-PRESSURE LAMINATE MATCHES OR CONTACT CUSTOMER SERVICE
- SHIPPED ASSEMBLED

FULL CARTON

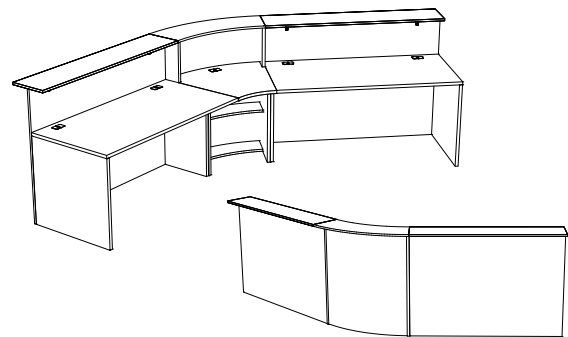
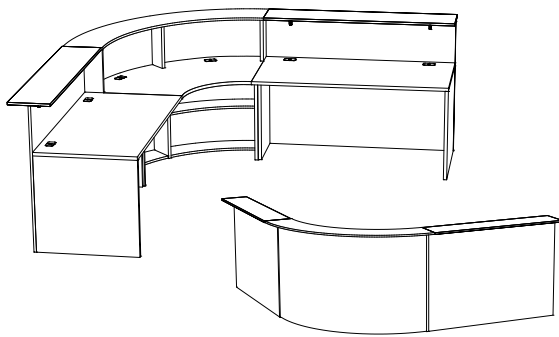

**EXAMPLE A**

|                        |  |
|------------------------|--|
| <b>388-3060GCT-CGA</b> | GALLERY CONNECTOR                      |
| <b>388-3654GCVRCM</b>  | GALLERY CURVED RECEPTION CORNER MODULE |
| <b>388-3060GCT-AGC</b> | GALLERY CONNECTOR                      |

**EXAMPLE B**

|                        |  |
|------------------------|--|
| <b>388-3060GCT-CGA</b> | GALLERY CONNECTOR                            |
| <b>388-3627GCVRCW</b>  | GALLERY CURVED RECEPTION CORNER MODULE WEDGE |
| <b>388-3060GCT-AGC</b> | GALLERY CONNECTOR                            |

# RECEPTION SERIES

## DESK HEIGHT CURVED CORNER MODULES

| MODEL | LIST     | WEIGHT | CUBE            | W  | D  | H   |
|-------|----------|--------|-----------------|----|----|-----|
|       | 388 (1") | LBS    | FT <sup>3</sup> | IN | IN | 1IN |

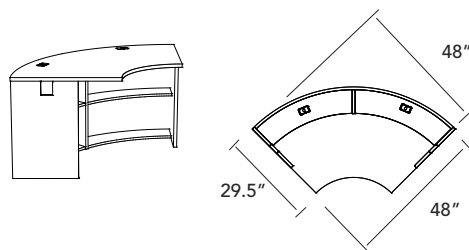

### DESK HEIGHT CURVED RECEPTION CORNER MODULE

RADIUS CORNER MODULE TOP

|                      |                |     |      |       |       |    |
|----------------------|----------------|-----|------|-------|-------|----|
| <b>388-3048CVRCM</b> | <b>\$4,250</b> | 135 | 42.8 | 47.25 | 47.25 | 29 |
|----------------------|----------------|-----|------|-------|-------|----|

CORNER MODULE TOP

|                     |                |     |      |       |       |    |
|---------------------|----------------|-----|------|-------|-------|----|
| <b>388-3048CVCM</b> | <b>\$4,250</b> | 135 | 42.8 | 47.25 | 47.25 | 29 |
|---------------------|----------------|-----|------|-------|-------|----|

- TRANSACTION & FRONT PANELS ARE HIGH PRESSURE LAMINATE. SEE [HEARTWOOD.CA](http://HEARTWOOD.CA) FOR AVAILABLE HIGH-PRESSURE LAMINATE MATCHES OR CONTACT CUSTOMER SERVICE
- SHIPPED ASSEMBLED

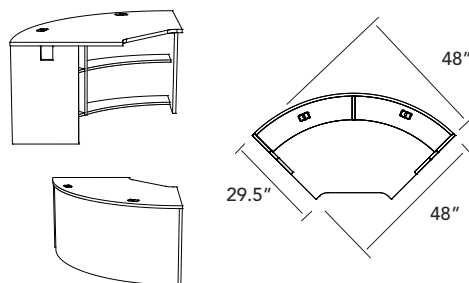

### DESK HEIGHT CURVED RECEPTION CORNER MODULE WEDGE

RADIUS CORNER MODULE TOP

|                      |                |    |      |    |      |    |
|----------------------|----------------|----|------|----|------|----|
| <b>388-3024CVRCW</b> | <b>\$3,583</b> | 87 | 20.3 | 34 | 29.5 | 29 |
|----------------------|----------------|----|------|----|------|----|

- TRANSACTION & FRONT PANELS ARE HIGH PRESSURE LAMINATE. SEE [HEARTWOOD.CA](http://HEARTWOOD.CA) FOR AVAILABLE HIGH-PRESSURE LAMINATE MATCHES OR CONTACT CUSTOMER SERVICE
- SHIPPED ASSEMBLED

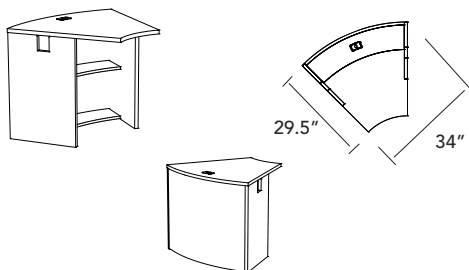

FULL CARTON

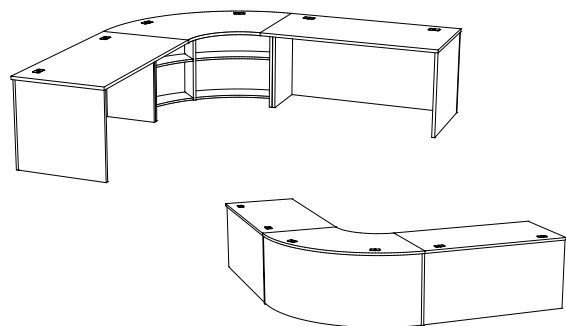

#### EXAMPLE A

|                       |  |
|-----------------------|--|
| <b>388-3060CT-ATC</b> | DESK HEIGHT CONNECTORS                     |
| <b>388-3048CVRCM</b>  | DESK HEIGHT CURVED RECEPTION CORNER MODULE |
| <b>388-3060CT-CTA</b> | DESK HEIGHT CONNECTORS                     |

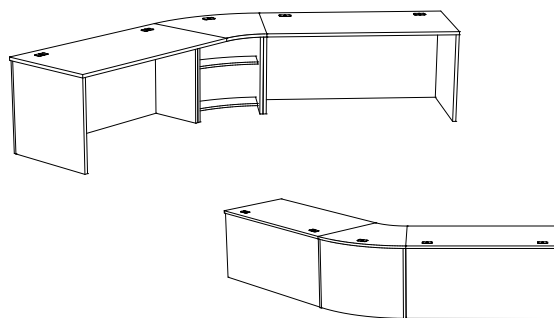

#### EXAMPLE B

|                       |  |
|-----------------------|--|
| <b>388-3060CT-ATC</b> | DESK HEIGHT CONNECTORS                           |
| <b>388-3024CVRCW</b>  | DESK HEIGHT CURVED RECEPTION CORNER MODULE WEDGE |
| <b>388-3060CT-CTA</b> | DESK HEIGHT CONNECTORS                           |

| MODEL | LIST     | WEIGHT | CUBE            | W  | D  | H   |
|-------|----------|--------|-----------------|----|----|-----|
|       | 388 (1") | LBS    | FT <sup>3</sup> | IN | IN | 1IN |

**GALLERY CONNECTOR WITH WATERFALL FOR HEIGHT ADJUSTABLE**

AGC - LEFT FULL GABLE, TALL BACK, RIGHT CONNECTING GABLE

CGC - LEFT CONNECTING GABLE, TALL BACK, RIGHT CONNECTING GABLE

CGA - RIGHT FULL GABLE, TALL BACK, LEFT CONNECTING GABLE

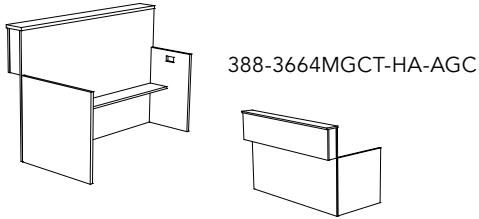

388-3664MGCT-HA-AGC

USED FOR 48 WIDE HEIGHT ADJUSTABLE DESK

|                     |         |     |     |       |      |    |
|---------------------|---------|-----|-----|-------|------|----|
| 388-3652MGCT-HA-AGC | \$2,451 | 112 | 5.1 | 51.25 | 35.5 | 43 |
| 388-3652MGCT-HA-CGC | \$2,451 | 112 | 5.1 | 51.25 | 35.5 | 43 |
| 388-3652MGCT-HA-CGA | \$2,451 | 112 | 5.1 | 51.25 | 35.5 | 43 |

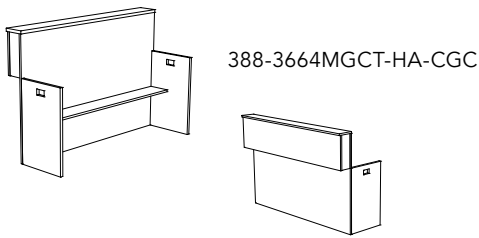

388-3664MGCT-HA-CGC

USED FOR 60 WIDE HEIGHT ADJUSTABLE DESK

|                     |         |     |     |    |      |    |
|---------------------|---------|-----|-----|----|------|----|
| 388-3664MGCT-HA-AGC | \$2,513 | 129 | 6.2 | 63 | 35.5 | 43 |
| 388-3664MGCT-HA-CGC | \$2,513 | 129 | 6.2 | 63 | 35.5 | 43 |
| 388-3664MGCT-HA-CGA | \$2,513 | 129 | 6.2 | 63 | 35.5 | 43 |

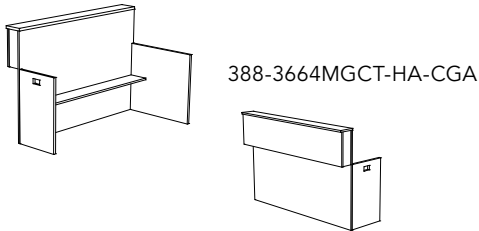

388-3664MGCT-HA-CGA

USED FOR 72 WIDE HEIGHT ADJUSTABLE DESK

|                     |         |     |     |    |      |    |
|---------------------|---------|-----|-----|----|------|----|
| 388-3676MGCT-HA-AGC | \$2,601 | 147 | 7.4 | 75 | 35.5 | 43 |
| 388-3676MGCT-HA-CGC | \$2,601 | 147 | 7.4 | 75 | 35.5 | 43 |
| 388-3676MGCT-HA-CGA | \$2,601 | 147 | 7.4 | 75 | 35.5 | 43 |

- SHIPPED READY TO ASSEMBLE

**RTA**

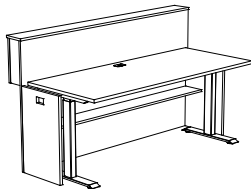

**EXAMPLE A**

|                     |                                  |
|---------------------|----------------------------------|
| 388-3676MGCT-HA-CGA | GALLERY CONNECTOR WITH WATERFALL |
| ATH-E1-2LEG         | ATHENA 2 LEG BASE                |
| CAL-REC3072         | 30" RECTANGLE TOP                |

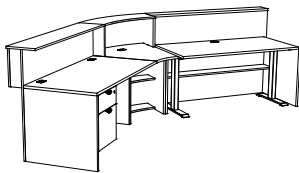

**EXAMPLE B**

|                     |   |
|---------------------|---|
| 388-3664MGCT-HA-CGA | GALLERY CONNECTOR WITH WATERFALL FOR HEIGHT ADJUSTABLE      |
| ATH-E1-2LEG         | ATHENA 2 LEG BASE   |
| CAL-REC3060         | 30" RECTANGLE TOP   |
| 388-3627MGCVRCW     | GALLERY CURVED RECEPTION CORNER MODULE WEDGE WITH WATERFALL |
| 388-3060GCT-AGC     | GALLERY CONNECTOR   |
| 388-HPF             | BOX/FILE HANGING PEDESTAL                                   |

**RECEPTION SERIES**  
**GALLERY CONNECTORS/DESKING FOR HEIGHT-ADJUSTABLE**

| MODEL | LIST     | WEIGHT | CUBE            | W  | D  | H   |
|-------|----------|--------|-----------------|----|----|-----|
|       | 388 (1") | LBS    | FT <sup>3</sup> | IN | IN | 1IN |

**GALLERY CONNECTOR FOR HEIGHT ADJUSTABLE**

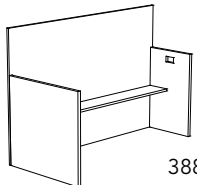

388-3064GCT-HA-AGC

**AGC** - LEFT FULL GABLE, TALL BACK, RIGHT CONNECTING GABLE  
**CGC** - LEFT CONNECTING GABLE, TALL BACK, RIGHT CONNECTING GABLE  
**CGA** - RIGHT FULL GABLE, TALL BACK, LEFT CONNECTING GABLE

USED FOR 48 WIDE HEIGHT ADJUSTABLE DESK

|                    |                |    |     |       |      |       |
|--------------------|----------------|----|-----|-------|------|-------|
| 388-3052GCT-HA-AGC | <b>\$2,262</b> | 82 | 5.1 | 51.25 | 29.5 | 42.25 |
| 388-3052GCT-HA-CGC | <b>\$2,262</b> | 82 | 5.1 | 51.25 | 29.5 | 42.25 |
| 388-3052GCT-HA-CGA | <b>\$2,262</b> | 82 | 5.1 | 51.25 | 29.5 | 42.25 |

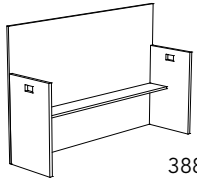

388-3064GCT-HA-CGC

USED FOR 60 WIDE HEIGHT ADJUSTABLE DESK

|                    |                |    |     |    |      |       |
|--------------------|----------------|----|-----|----|------|-------|
| 388-3064GCT-HA-AGC | <b>\$2,327</b> | 93 | 6.2 | 63 | 29.5 | 42.25 |
| 388-3064GCT-HA-CGC | <b>\$2,327</b> | 93 | 6.2 | 63 | 29.5 | 42.25 |
| 388-3064GCT-HA-CGA | <b>\$2,327</b> | 93 | 6.2 | 63 | 29.5 | 42.25 |

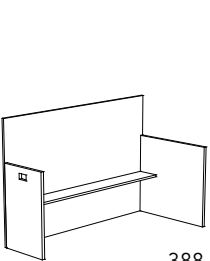

388-3064GCT-HA-CGA

USED FOR 72 WIDE HEIGHT ADJUSTABLE DESK

|                    |                |     |     |    |      |       |
|--------------------|----------------|-----|-----|----|------|-------|
| 388-3076GCT-HA-AGC | <b>\$2,414</b> | 104 | 7.4 | 75 | 29.5 | 42.25 |
| 388-3076GCT-HA-CGC | <b>\$2,414</b> | 104 | 7.4 | 75 | 29.5 | 42.25 |
| 388-3076GCT-HA-CGA | <b>\$2,414</b> | 104 | 7.4 | 75 | 29.5 | 42.25 |

- SHIPPED READY TO ASSEMBLE

**RTA**

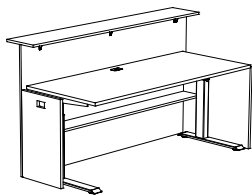

**EXAMPLE B**

|                    |   |
|--------------------|---|
| 388-3076GCT-HA-CGC | GALLERY CONNECTOR FOR HEIGHT ADJUSTABLE |
| 388-1276MGT        | STRAIGHT GALLERY TOP                    |
| CAL-E1-2LEG        | HEIGHT ADJUSTABLE 2 LEG BASE            |
| CAL-REC3072        | 30" RECTANGLE TOP                       |



| MODEL | LIST<br>388 (1") | WEIGHT<br>LBS | CUBE<br>FT <sup>3</sup> | W<br>IN | D<br>IN | H<br>1IN |
|-------|------------------|---------------|-------------------------|---------|---------|----------|
|-------|------------------|---------------|-------------------------|---------|---------|----------|

**GALLERY CONNECTOR WITH WATERFALL**

**AGC** - LEFT FULL GABLE, TALL BACK, RIGHT CONNECTING GABLE  
**CGC** - LEFT CONNECTING GABLE, TALL BACK, RIGHT CONNECTING GABLE  
**CGA** - RIGHT CONNECTING GABLE, TALL BACK, LEFT FULL GABLE

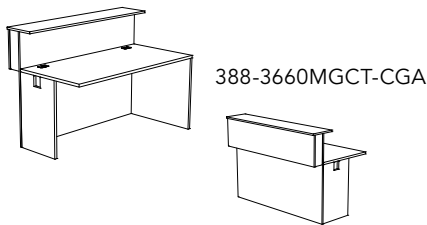
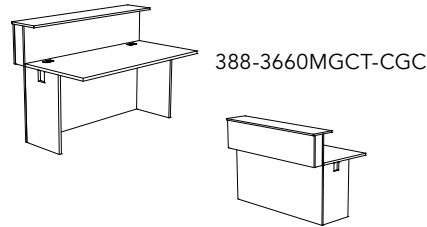
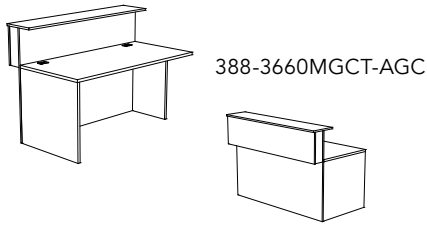

48" CONNECTORS

|                         |                |            |            |              |             |           |
|-------------------------|----------------|------------|------------|--------------|-------------|-----------|
| <b>388-3648MGCT-AGC</b> | <b>\$2,601</b> | <b>134</b> | <b>4.7</b> | <b>47.25</b> | <b>35.5</b> | <b>43</b> |
| <b>388-3648MGCT-CGC</b> | <b>\$2,601</b> | <b>134</b> | <b>4.7</b> | <b>47.25</b> | <b>35.5</b> | <b>43</b> |
| <b>388-3648MGCT-CGA</b> | <b>\$2,601</b> | <b>134</b> | <b>4.7</b> | <b>47.25</b> | <b>35.5</b> | <b>43</b> |

60" CONNECTORS

|                         |                |            |            |              |             |           |
|-------------------------|----------------|------------|------------|--------------|-------------|-----------|
| <b>388-3660MGCT-AGC</b> | <b>\$2,664</b> | <b>156</b> | <b>5.9</b> | <b>59.25</b> | <b>35.5</b> | <b>43</b> |
| <b>388-3660MGCT-CGC</b> | <b>\$2,664</b> | <b>156</b> | <b>5.9</b> | <b>59.25</b> | <b>35.5</b> | <b>43</b> |
| <b>388-3660MGCT-CGA</b> | <b>\$2,664</b> | <b>156</b> | <b>5.9</b> | <b>59.25</b> | <b>35.5</b> | <b>43</b> |

72" CONNECTORS

|                         |                |            |          |           |             |           |
|-------------------------|----------------|------------|----------|-----------|-------------|-----------|
| <b>388-3672MGCT-AGC</b> | <b>\$2,776</b> | <b>182</b> | <b>7</b> | <b>71</b> | <b>35.5</b> | <b>43</b> |
| <b>388-3672MGCT-CGC</b> | <b>\$2,776</b> | <b>182</b> | <b>7</b> | <b>71</b> | <b>35.5</b> | <b>43</b> |
| <b>388-3672MGCT-CGA</b> | <b>\$2,776</b> | <b>182</b> | <b>7</b> | <b>71</b> | <b>35.5</b> | <b>43</b> |

- SHIPPED READY TO ASSEMBLE

**RTA**

**GALLERY CONNECTOR**

**AGC** - LEFT FULL GABLE, TALL BACK, RIGHT CONNECTING GABLE  
**CGC** - LEFT CONNECTING GABLE, TALL BACK, RIGHT CONNECTING GABLE  
**CGA** - RIGHT CONNECTING GABLE, TALL BACK, LEFT FULL GABLE

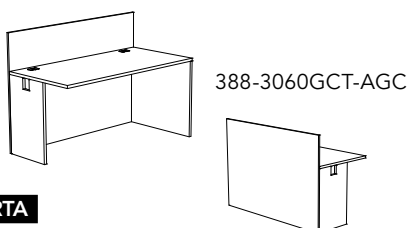
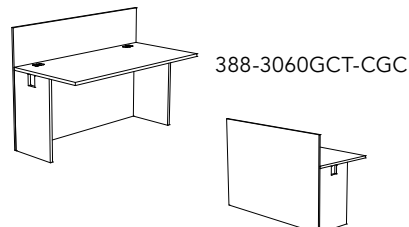
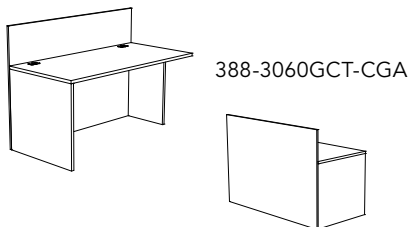

|                        |                |            |            |              |             |              |
|------------------------|----------------|------------|------------|--------------|-------------|--------------|
| <b>388-3048GCT-AGC</b> | <b>\$2,101</b> | <b>107</b> | <b>4.7</b> | <b>47.25</b> | <b>29.5</b> | <b>42.25</b> |
| <b>388-3048GCT-CGC</b> | <b>\$2,101</b> | <b>107</b> | <b>4.7</b> | <b>47.25</b> | <b>29.5</b> | <b>42.25</b> |
| <b>388-3048GCT-CGA</b> | <b>\$2,101</b> | <b>107</b> | <b>4.7</b> | <b>47.25</b> | <b>29.5</b> | <b>42.25</b> |

|                        |                |            |            |              |             |              |
|------------------------|----------------|------------|------------|--------------|-------------|--------------|
| <b>388-3060GCT-AGC</b> | <b>\$2,163</b> | <b>125</b> | <b>5.9</b> | <b>59.25</b> | <b>29.5</b> | <b>42.25</b> |
| <b>388-3060GCT-CGC</b> | <b>\$2,163</b> | <b>125</b> | <b>5.9</b> | <b>59.25</b> | <b>29.5</b> | <b>42.25</b> |
| <b>388-3060GCT-CGA</b> | <b>\$2,163</b> | <b>125</b> | <b>5.9</b> | <b>59.25</b> | <b>29.5</b> | <b>42.25</b> |

|                        |                |            |          |           |             |              |
|------------------------|----------------|------------|----------|-----------|-------------|--------------|
| <b>388-3072GCT-AGC</b> | <b>\$2,276</b> | <b>144</b> | <b>7</b> | <b>71</b> | <b>29.5</b> | <b>42.25</b> |
| <b>388-3072GCT-CGC</b> | <b>\$2,276</b> | <b>144</b> | <b>7</b> | <b>71</b> | <b>29.5</b> | <b>42.25</b> |
| <b>388-3072GCT-CGA</b> | <b>\$2,276</b> | <b>144</b> | <b>7</b> | <b>71</b> | <b>29.5</b> | <b>42.25</b> |

- SHIPPED READY TO ASSEMBLE

**RTA**

## RECEPTION SERIES GALLERY TRANSACTION TOPS

| MODEL | LIST     | WEIGHT | CUBE            | W  | D  | H   |
|-------|----------|--------|-----------------|----|----|-----|
|       | 388 (1") | LBS    | FT <sup>3</sup> | IN | IN | 1IN |

### STRAIGHT GALLERY TOP

USED ON GALLERY CONNECTOR



388-1260MGT

|             |       |    |   |       |    |      |
|-------------|-------|----|---|-------|----|------|
| 388-1248MGT | \$413 | 20 | 1 | 47.25 | 12 | 0.75 |
| 388-1252MGT | \$451 | 25 | 1 | 51.25 | 12 | 0.75 |
| 388-1260MGT | \$473 | 30 | 1 | 59.25 | 12 | 0.75 |
| 388-1264MGT | \$490 | 35 | 1 | 63    | 12 | 0.75 |
| 388-1272MGT | \$502 | 42 | 1 | 71    | 12 | 0.75 |
| 388-1276MGT | \$524 | 48 | 1 | 75    | 12 | 0.75 |

- SHIPPED READY TO ASSEMBLE

RTA

## RECEPTION SERIES DESK HEIGHT CONNECTORS/DESKING

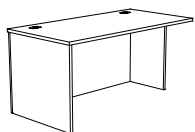

388-3060CT-ATC

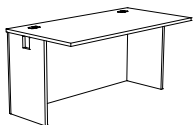
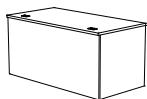

388-3060CT-CTC

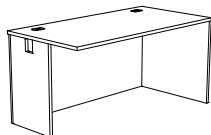
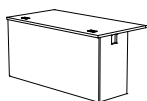

388-3060CT-CTA

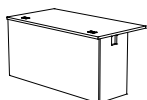

### DESK HEIGHT CONNECTORS

ATC - LEFT FULL GABLE, THRU BACK, RIGHT CONNECTING GABLE

CTC - LEFT CONNECTING GABLE, THRU BACK, RIGHT CONNECTING GABLE

CTA - RIGHT CONNECTING GABLE, THRU BACK, LEFT FULL GABLE

48" CONNECTORS

|                |       |     |     |       |      |    |
|----------------|-------|-----|-----|-------|------|----|
| 388-3048CT-ATC | \$924 | 105 | 4.7 | 47.25 | 29.5 | 29 |
| 388-3048CT-CTC | \$924 | 105 | 4.7 | 47.25 | 29.5 | 29 |
| 388-3048CT-CTA | \$924 | 105 | 4.7 | 47.25 | 29.5 | 29 |

60" CONNECTORS

|                |       |     |     |       |      |    |
|----------------|-------|-----|-----|-------|------|----|
| 388-3060CT-ATC | \$995 | 124 | 5.9 | 59.25 | 29.5 | 29 |
| 388-3060CT-CTC | \$995 | 124 | 5.9 | 59.25 | 29.5 | 29 |
| 388-3060CT-CTA | \$995 | 124 | 5.9 | 59.25 | 29.5 | 29 |

72" CONNECTORS

|                |         |     |   |    |      |    |
|----------------|---------|-----|---|----|------|----|
| 388-3072CT-ATC | \$1,052 | 142 | 7 | 71 | 29.5 | 29 |
| 388-3072CT-CTC | \$1,052 | 142 | 7 | 71 | 29.5 | 29 |
| 388-3072CT-CTA | \$1,052 | 142 | 7 | 71 | 29.5 | 29 |

- SHIPPED READY TO ASSEMBLE

RTA

| MODEL | LIST     | LIST      | WEIGHT | CUBE            | W  | D  | H   | H    |
|-------|----------|-----------|--------|-----------------|----|----|-----|------|
|       | 388 (1") | 600 (1½") | LBS    | FT <sup>3</sup> | IN | IN | 1IN | 1½IN |

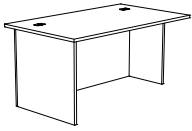

388-3060CT-ATC

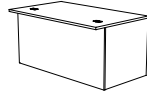

388-3060CT-CTC

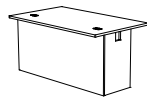

388-3060CT-CTA

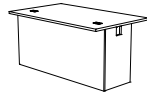
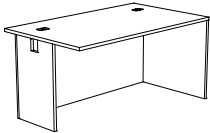

**DESK HEIGHT CONNECTOR TOP WITH OVERHANG**

**ATC** - LEFT FULL GABLE, THRU BACK, RIGHT CONNECTING GABLE

**CTC** - LEFT CONNECTING GABLE, THRU BACK, RIGHT CONNECTING GABLE

**CTA** - RIGHT CONNECTING GABLE, THRU BACK, LEFT FULL GABLE

48" CONNECTORS WITH 6" OVERHANG

|                         |              |            |            |              |             |           |
|-------------------------|--------------|------------|------------|--------------|-------------|-----------|
| <b>388-OH3648CT-ATC</b> | <b>\$924</b> | <b>105</b> | <b>4.7</b> | <b>47.25</b> | <b>35.5</b> | <b>29</b> |
|-------------------------|--------------|------------|------------|--------------|-------------|-----------|

|                         |              |            |            |              |             |           |
|-------------------------|--------------|------------|------------|--------------|-------------|-----------|
| <b>388-OH3648CT-CTC</b> | <b>\$924</b> | <b>105</b> | <b>4.7</b> | <b>47.25</b> | <b>35.5</b> | <b>29</b> |
|-------------------------|--------------|------------|------------|--------------|-------------|-----------|

|                         |              |            |            |              |             |           |
|-------------------------|--------------|------------|------------|--------------|-------------|-----------|
| <b>388-OH3648CT-CTA</b> | <b>\$924</b> | <b>105</b> | <b>4.7</b> | <b>47.25</b> | <b>35.5</b> | <b>29</b> |
|-------------------------|--------------|------------|------------|--------------|-------------|-----------|

60" CONNECTORS WITH 6" OVERHANG

|                         |              |            |            |              |             |           |
|-------------------------|--------------|------------|------------|--------------|-------------|-----------|
| <b>388-OH3660CT-ATC</b> | <b>\$995</b> | <b>124</b> | <b>5.9</b> | <b>59.25</b> | <b>35.5</b> | <b>29</b> |
|-------------------------|--------------|------------|------------|--------------|-------------|-----------|

|                         |              |            |            |              |             |           |
|-------------------------|--------------|------------|------------|--------------|-------------|-----------|
| <b>388-OH3660CT-CTC</b> | <b>\$995</b> | <b>124</b> | <b>5.9</b> | <b>59.25</b> | <b>35.5</b> | <b>29</b> |
|-------------------------|--------------|------------|------------|--------------|-------------|-----------|

|                         |              |            |            |              |             |           |
|-------------------------|--------------|------------|------------|--------------|-------------|-----------|
| <b>388-OH3660CT-CTA</b> | <b>\$995</b> | <b>124</b> | <b>5.9</b> | <b>59.25</b> | <b>35.5</b> | <b>29</b> |
|-------------------------|--------------|------------|------------|--------------|-------------|-----------|

72" CONNECTORS WITH 6" OVERHANG

|                         |                |            |          |           |             |           |
|-------------------------|----------------|------------|----------|-----------|-------------|-----------|
| <b>388-OH3672CT-ATC</b> | <b>\$1,052</b> | <b>142</b> | <b>7</b> | <b>71</b> | <b>35.5</b> | <b>29</b> |
|-------------------------|----------------|------------|----------|-----------|-------------|-----------|

|                         |                |            |          |           |             |           |
|-------------------------|----------------|------------|----------|-----------|-------------|-----------|
| <b>388-OH3672CT-CTC</b> | <b>\$1,052</b> | <b>142</b> | <b>7</b> | <b>71</b> | <b>35.5</b> | <b>29</b> |
|-------------------------|----------------|------------|----------|-----------|-------------|-----------|

|                         |                |            |          |           |             |           |
|-------------------------|----------------|------------|----------|-----------|-------------|-----------|
| <b>388-OH3672CT-CTA</b> | <b>\$1,052</b> | <b>142</b> | <b>7</b> | <b>71</b> | <b>35.5</b> | <b>29</b> |
|-------------------------|----------------|------------|----------|-----------|-------------|-----------|

**RTA**

- SHIPPED READY TO ASSEMBLE

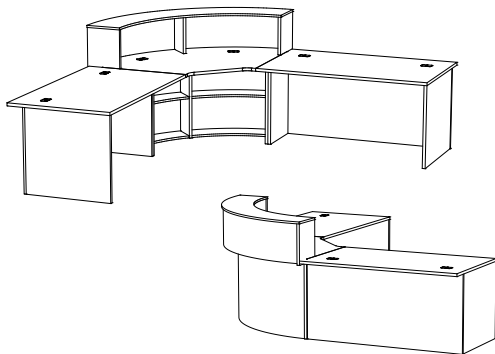

**EXAMPLE A**

|                         |   |
|-------------------------|---|
| <b>388-OH3660CT-ATC</b> | DESK HEIGHT CONNECTOR TOP WITH OVERHANG               |
| <b>388-3654MGCVCM</b>   | GALLERY CURVED RECEPTION CORNER MODULE WITH WATERFALL |
| <b>388-OH3660CT-CTA</b> | DESK HEIGHT CONNECTOR TOP WITH OVERHANG               |

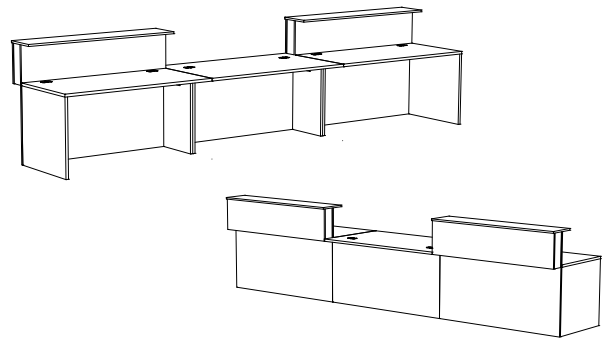

**EXAMPLE B**

|                         |   |
|-------------------------|---|
| <b>388-3660MGCT-AGC</b> | GALLERY CONNECTOR WITH WATERFALL        |
| <b>388-OH3660CT-CTC</b> | DESK HEIGHT CONNECTOR TOP WITH OVERHANG |
| <b>388-3660MGCT-CGA</b> | GALLERY CONNECTOR WITH WATERFALL        |

| MODEL | LIST     | LIST      | WEIGHT | CUBE            | W  | D  | H   | H    |
|-------|----------|-----------|--------|-----------------|----|----|-----|------|
|       | 388 (1") | 600 (1½") | LBS    | FT <sup>3</sup> | IN | IN | 1IN | 1½IN |

Our modern reception desk features waterfall transaction counters and a two-tone colour design.

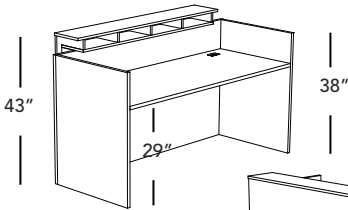
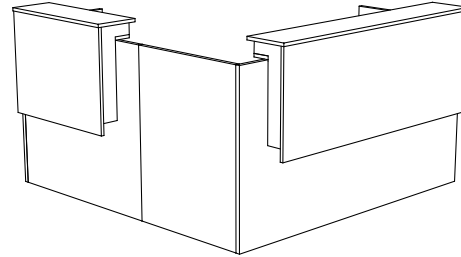
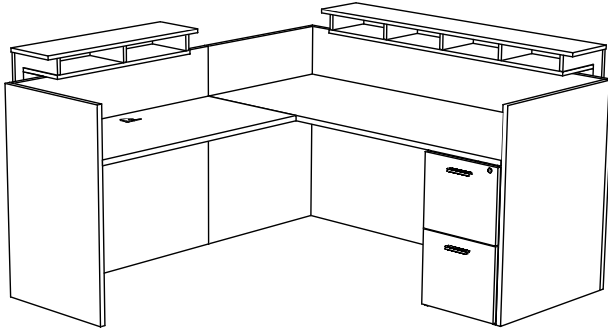

388-3672MGDS

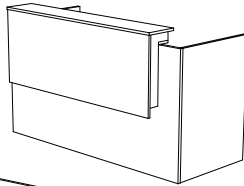

388-3684MGDS+C

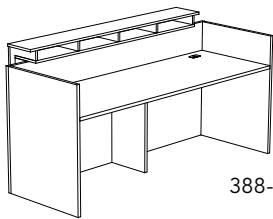

**MODERN RECEPTION DESK**

|                |         |         |        |       |       |      |    |    |
|----------------|---------|---------|--------|-------|-------|------|----|----|
| 388-3666MGDS   | \$2,831 | \$3,227 | 220.46 | 8.83  | 65    | 35.5 | 43 | 43 |
| 388-3672MGDS   | \$2,981 | \$3,398 | 242.51 | 10.59 | 71    | 35.5 | 43 | 43 |
| 388-3684MGDS+C | \$3,218 | \$3,669 | 264.55 | 12.71 | 82.75 | 35.5 | 43 | 43 |

- TWO-TONE WATERFALL DESIGN TRANSACTION TOP
- TRANSACTION SHELF BOTTOM, CUBBY DIVIDERS AND SIDE PANELS ARE PURE WHITE (PW). TOPS AND BACKS MATCH UNIT COLOUR.
- SEE ONLINE WEB IMAGES FOR TWO-TONE DESIGN CONCEPT
- 3" CUBBY CAVITY HEIGHT

**AVAILABLE FINISHES:** ALL STANDARD HEARTWOOD LAMINATE FINISHES

**ORDERING TIPS:** "TOP & BODY" REFERS TO GALLERY DESK PORTION WHILE "FACE" REFERS TO THE WATERFALL TRANSACTION TOP & FRONT

**RTA**

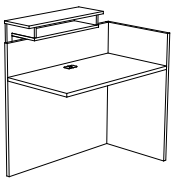

388-3042MGRS

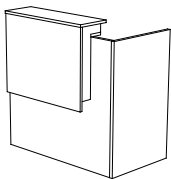

**NON-HANDED MODERN RECEPTION DESK RETURN**

|              |         |         |        |      |       |      |    |    |
|--------------|---------|---------|--------|------|-------|------|----|----|
| 388-3036MGRS | \$1,370 | \$1,562 | 114.64 | 3.88 | 35.5  | 29.5 | 43 | 43 |
| 388-3042MGRS | \$1,471 | \$1,677 | 125.66 | 4.59 | 41.5  | 29.5 | 43 | 43 |
| 388-3048MGRS | \$1,547 | \$1,764 | 136.69 | 5.3  | 47.25 | 29.5 | 43 | 43 |

- TWO-TONE WATERFALL DESIGN TRANSACTION TOP
- TRANSACTION SHELF BOTTOM, CUBBY DIVIDERS AND SIDE PANELS ARE PURE WHITE (PW). TOPS AND BACKS MATCH UNIT COLOUR.
- SEE ONLINE WEB IMAGES FOR TWO-TONE DESIGN CONCEPT
- 3" CUBBY CAVITY HEIGHT

**AVAILABLE FINISHES:** ALL STANDARD HEARTWOOD LAMINATE FINISHES

**ORDERING TIPS:** "TOP & BODY" REFERS TO GALLERY DESK PORTION WHILE "FACE" REFERS TO THE WATERFALL TRANSACTION TOP & FRONT

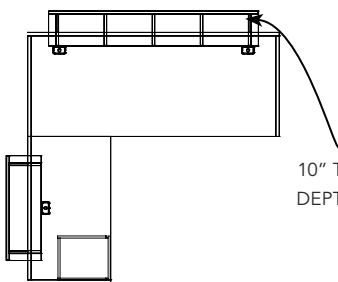

10" TRANSACTION COUNTER  
 DEPTH WITH A 6" OVERHANG

| MODEL | LIST     | LIST      | WEIGHT | CUBE            | W  | D  | H   | H    |
|-------|----------|-----------|--------|-----------------|----|----|-----|------|
|       | 388 (1") | 600 (1½") | LBS    | FT <sup>3</sup> | IN | IN | 1IN | 1½IN |

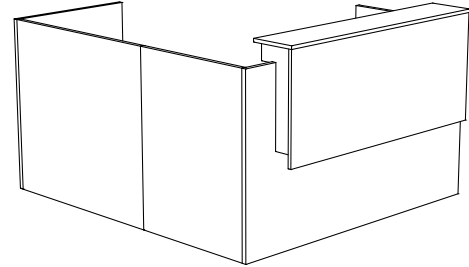
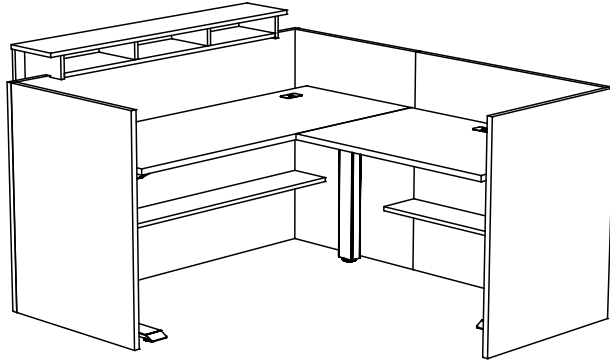

**HEIGHT ADJUSTABLE SHROUD FOR NON-HANDED MODERN RECEPTION DESK**

|                 |         |     |       |     |    |      |    |     |
|-----------------|---------|-----|-------|-----|----|------|----|-----|
| 388-3066MGDS-HA | \$2,560 | N/A | 211.2 | 7.6 | 65 | 35.5 | 43 | N/A |
| 388-3072MGDS-HA | \$2,740 | N/A | 226.5 | 8.9 | 71 | 35.5 | 43 | N/A |

- DESIGNED FOR USE WITH ATHENA & CALYPSO HEIGHT-ADJUSTABLE BASES
- HEIGHT ADJUSTABLE BASE IS REQUIRED TO SUPPORT THE DESK AND/OR RETURN TOPS
- CUTBACK TOP TO CLEAR HORIZONTAL CUBBY

**AVAILABLE FINISHES:** ALL STANDARD HEARTWOOD LAMINATE FINISHES

**ORDERING TIPS:** "TOP & BODY" REFERS TO GALLERY DESK PORTION WHILE "FACE" REFERS TO THE WATERFALL TRANSACTION TOP & FRONT

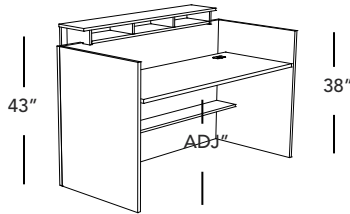

388-3066MGDS-HA

**HEIGHT ADJUSTABLE SHROUD FOR NON-HANDED MODERN RECEPTION RETURN**

|                 |         |     |       |     |       |      |    |     |
|-----------------|---------|-----|-------|-----|-------|------|----|-----|
| 388-3036MGRS-HA | \$1,108 | N/A | 90.5  | 2.2 | 35.5  | 29.5 | 38 | N/A |
| 388-3042MGRS-HA | \$1,171 | N/A | 101.2 | 2.9 | 41.5  | 29.5 | 38 | N/A |
| 388-3048MGRS-HA | \$1,251 | N/A | 112   | 3.7 | 47.25 | 29.5 | 38 | N/A |

- DESIGNED FOR USE WITH ATHENA & CALYPSO HEIGHT-ADJUSTABLE BASES
- HEIGHT ADJUSTABLE BASE IS REQUIRED TO SUPPORT THE DESK AND/OR RETURN TOPS
- NOT AVAILABLE IN WATERFALL DESIGN

**AVAILABLE FINISHES:** ALL STANDARD HEARTWOOD LAMINATE FINISHES

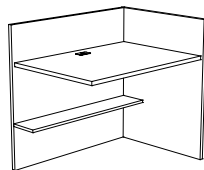

388-3042MGRS-HA

FOR COMPATIBLE HEIGHT-ADJUSTABLE DESKING OPTIONS, SEE HEIGHT-ADJUSTABLE SERIES PAGE [HT-ADJ-2](#)

**RECEPTION SERIES**  
**ADD-ON LAMINATE COMPONENTS FOR RECEPTION**

| MODEL | LIST     | LIST      | WEIGHT | CUBE            | W  | D  | H   | H    |
|-------|----------|-----------|--------|-----------------|----|----|-----|------|
|       | 388 (1") | 600 (1½") | LBS    | FT <sup>3</sup> | IN | IN | 1IN | 1½IN |

Service counter and storage concepts when designing your reception workspace.

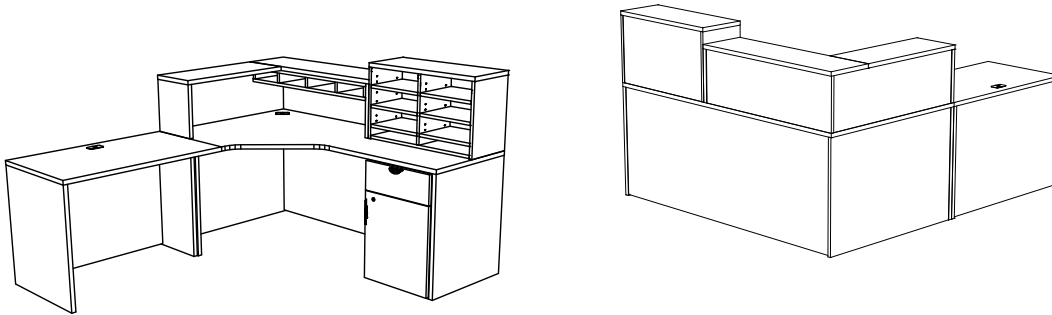

**TRANSACTION SHELVES**

**TRANSACTION SHELVES - SITS ON TOP OF WORKSURFACE**

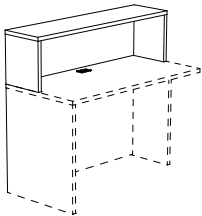
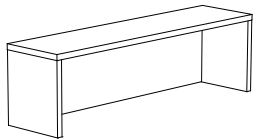

**RTA**

|            |       |       |    |     |       |    |    |    |
|------------|-------|-------|----|-----|-------|----|----|----|
| 388-1430TA | \$428 | \$488 | 32 | 0.8 | 29.5  | 12 | 14 | 14 |
| 388-1436TA | \$428 | \$488 | 34 | 0.9 | 35.5  | 12 | 14 | 14 |
| 388-1442TA | \$428 | \$488 | 37 | 1.1 | 41.5  | 12 | 14 | 14 |
| 388-1448TA | \$428 | \$488 | 40 | 1.2 | 47.25 | 12 | 14 | 14 |
| 388-1454TA | \$479 | \$546 | 44 | 1.4 | 53.25 | 12 | 14 | 14 |
| 388-1460TA | \$479 | \$546 | 46 | 1.5 | 59.25 | 12 | 14 | 14 |
| 388-1466TA | \$544 | \$620 | 52 | 1.7 | 65    | 12 | 14 | 14 |
| 388-1472TA | \$544 | \$620 | 58 | 1.8 | 71    | 12 | 14 | 14 |

**CORNER TRANSACTION SHELVES - SITS ON TOP OF WORKSURFACE**

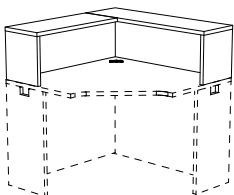
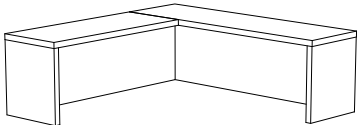

**RTA**

|             |       |       |    |     |                 |    |    |    |
|-------------|-------|-------|----|-----|-----------------|----|----|----|
| 388-1436CTA | \$527 | \$601 | 46 | 1.2 | 35.5/<br>35.5   | 12 | 14 | 14 |
| 388-1442CTA | \$571 | \$651 | 53 | 1.4 | 41.5/<br>41.5   | 12 | 14 | 14 |
| 388-1448CTA | \$621 | \$708 | 60 | 1.6 | 47.25/<br>47.25 | 12 | 14 | 14 |

| MODEL | LIST     | LIST      | WEIGHT | CUBE            | W  | D  | H   | H    |
|-------|----------|-----------|--------|-----------------|----|----|-----|------|
|       | 388 (1") | 600 (1½") | LBS    | FT <sup>3</sup> | IN | IN | 1IN | 1½IN |

**DESKTOP ORGANIZER - 12" DEEP UNIT**

1 DIVIDER, 6 ADJUSTABLE SHELVES

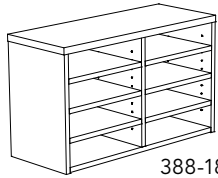

388-1830DTO

|             |       |       |    |   |       |    |       |       |
|-------------|-------|-------|----|---|-------|----|-------|-------|
| 388-1824DTO | \$585 | \$649 | 46 | 2 | 23.75 | 12 | 17.75 | 17.25 |
|-------------|-------|-------|----|---|-------|----|-------|-------|

|             |       |       |    |   |      |    |       |       |
|-------------|-------|-------|----|---|------|----|-------|-------|
| 388-1830DTO | \$593 | \$658 | 49 | 2 | 29.5 | 12 | 17.75 | 17.25 |
|-------------|-------|-------|----|---|------|----|-------|-------|

2 DIVIDERS, 9 ADJUSTABLE SHELVES

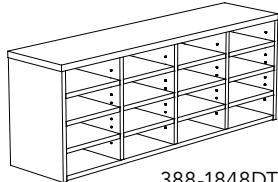

388-1848DTO

|             |       |       |    |   |      |    |       |       |
|-------------|-------|-------|----|---|------|----|-------|-------|
| 388-1836DTO | \$603 | \$669 | 52 | 2 | 35.5 | 12 | 17.75 | 17.25 |
|-------------|-------|-------|----|---|------|----|-------|-------|

|             |       |       |    |     |      |    |       |       |
|-------------|-------|-------|----|-----|------|----|-------|-------|
| 388-1842DTO | \$650 | \$722 | 56 | 2.3 | 41.5 | 12 | 17.75 | 17.25 |
|-------------|-------|-------|----|-----|------|----|-------|-------|

3 DIVIDERS, 12 ADJUSTABLE SHELVES

|             |       |       |    |     |       |    |       |       |
|-------------|-------|-------|----|-----|-------|----|-------|-------|
| 388-1848DTO | \$664 | \$737 | 62 | 2.7 | 47.25 | 12 | 17.75 | 17.25 |
|-------------|-------|-------|----|-----|-------|----|-------|-------|

- WILL FIT IN 36" HIGH HUTCH CAVITY
- FOR LETTER STORAGE. STAND ALONE UNIT W/ BACK.

1 DIVIDER, 8 ADJUSTABLE SHELVES

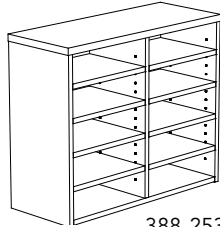

388-2530DTO

|             |       |       |    |   |       |    |       |       |
|-------------|-------|-------|----|---|-------|----|-------|-------|
| 388-2524DTO | \$593 | \$658 | 69 | 2 | 23.75 | 12 | 24.75 | 24.25 |
|-------------|-------|-------|----|---|-------|----|-------|-------|

|             |       |       |    |   |      |    |       |       |
|-------------|-------|-------|----|---|------|----|-------|-------|
| 388-2530DTO | \$602 | \$668 | 72 | 2 | 29.5 | 12 | 24.75 | 24.25 |
|-------------|-------|-------|----|---|------|----|-------|-------|

2 DIVIDERS, 12 ADJUSTABLE SHELVES

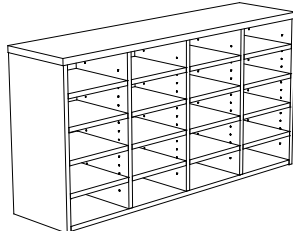

388-2548DTO

|             |       |       |    |   |      |    |       |       |
|-------------|-------|-------|----|---|------|----|-------|-------|
| 388-2536DTO | \$620 | \$688 | 76 | 2 | 35.5 | 12 | 24.75 | 24.25 |
|-------------|-------|-------|----|---|------|----|-------|-------|

|             |       |       |    |     |      |    |       |       |
|-------------|-------|-------|----|-----|------|----|-------|-------|
| 388-2542DTO | \$700 | \$777 | 82 | 2.3 | 41.5 | 12 | 24.75 | 24.25 |
|-------------|-------|-------|----|-----|------|----|-------|-------|

3 DIVIDERS, 16 ADJUSTABLE SHELVES

|             |       |       |    |     |       |    |       |       |
|-------------|-------|-------|----|-----|-------|----|-------|-------|
| 388-2548DTO | \$716 | \$795 | 89 | 2.7 | 47.25 | 12 | 24.75 | 24.25 |
|-------------|-------|-------|----|-----|-------|----|-------|-------|

- WILL FIT IN 43" HIGH HUTCH CAVITY
- FOR LETTER STORAGE. STAND ALONE UNIT W/ BACK.

**RTA**

**HORIZONTAL CUBBY-HOLE**

W/ ADJUSTABLE DIVIDERS - GREAT FOR ORGANIZING PAPER, ENVELOPES, ETC.

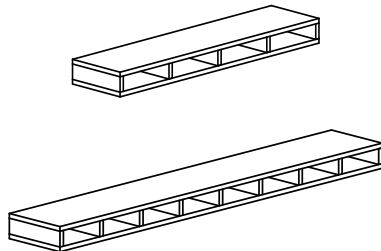

|            |       |     |    |   |      |    |   |     |
|------------|-------|-----|----|---|------|----|---|-----|
| 388-3004HC | \$303 | N/A | 11 | 1 | 27.5 | 11 | 4 | N/A |
|------------|-------|-----|----|---|------|----|---|-----|

|            |       |     |    |   |      |    |   |     |
|------------|-------|-----|----|---|------|----|---|-----|
| 388-3604HC | \$312 | N/A | 14 | 1 | 33.5 | 11 | 4 | N/A |
|------------|-------|-----|----|---|------|----|---|-----|

|            |       |     |    |   |      |    |   |     |
|------------|-------|-----|----|---|------|----|---|-----|
| 388-4204HC | \$361 | N/A | 17 | 1 | 39.5 | 11 | 4 | N/A |
|------------|-------|-----|----|---|------|----|---|-----|

|            |       |     |    |   |       |    |   |     |
|------------|-------|-----|----|---|-------|----|---|-----|
| 388-4804HC | \$368 | N/A | 20 | 2 | 45.75 | 11 | 4 | N/A |
|------------|-------|-----|----|---|-------|----|---|-----|

|            |       |     |    |   |       |    |   |     |
|------------|-------|-----|----|---|-------|----|---|-----|
| 388-5404HC | \$378 | N/A | 23 | 2 | 51.25 | 11 | 4 | N/A |
|------------|-------|-----|----|---|-------|----|---|-----|

|            |       |     |    |   |       |    |   |     |
|------------|-------|-----|----|---|-------|----|---|-----|
| 388-6004HC | \$405 | N/A | 26 | 2 | 57.25 | 11 | 4 | N/A |
|------------|-------|-----|----|---|-------|----|---|-----|

|            |       |     |    |   |    |    |   |     |
|------------|-------|-----|----|---|----|----|---|-----|
| 388-6604HC | \$435 | N/A | 29 | 2 | 63 | 11 | 4 | N/A |
|------------|-------|-----|----|---|----|----|---|-----|

|            |       |     |    |   |    |    |   |     |
|------------|-------|-----|----|---|----|----|---|-----|
| 388-7204HC | \$463 | N/A | 32 | 2 | 69 | 11 | 4 | N/A |
|------------|-------|-----|----|---|----|----|---|-----|

|            |       |     |    |     |    |    |   |     |
|------------|-------|-----|----|-----|----|----|---|-----|
| 388-7804HC | \$479 | N/A | 35 | 2.5 | 75 | 11 | 4 | N/A |
|------------|-------|-----|----|-----|----|----|---|-----|

|            |       |     |    |     |       |    |   |     |
|------------|-------|-----|----|-----|-------|----|---|-----|
| 388-8404HC | \$493 | N/A | 38 | 2.5 | 80.75 | 11 | 4 | N/A |
|------------|-------|-----|----|-----|-------|----|---|-----|

| MODEL | LIST     | LIST      | WEIGHT | CUBE            | W  | D  | H   | H    |
|-------|----------|-----------|--------|-----------------|----|----|-----|------|
|       | 388 (1") | 600 (1½") | LBS    | FT <sup>3</sup> | IN | IN | 1IN | 1½IN |

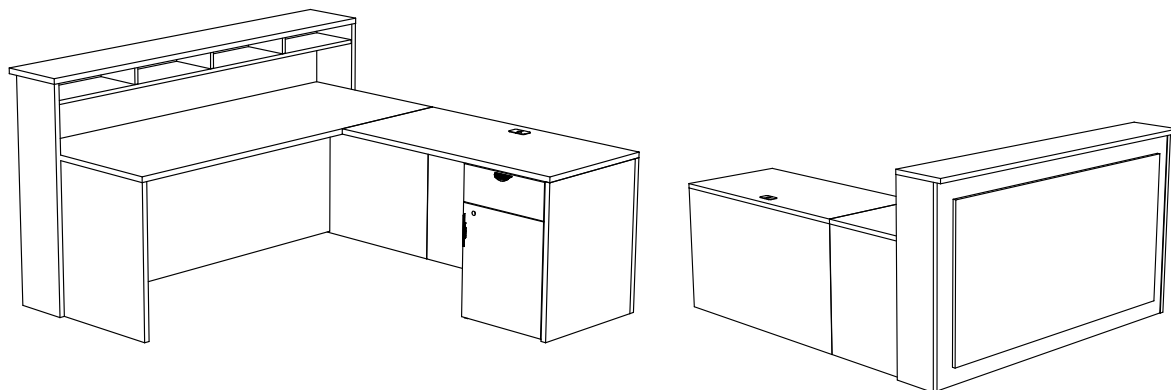

**GALLERY TRANSACTION SHELL (SURROUNDING SHELL)**

|                       |                |                |       |      |    |    |    |    |
|-----------------------|----------------|----------------|-------|------|----|----|----|----|
| <b>388-1268GTA-43</b> | <b>\$1,832</b> | <b>\$2,015</b> | 127.9 | 5.78 | 67 | 12 | 43 | 43 |
|-----------------------|----------------|----------------|-------|------|----|----|----|----|

SHELL FOR 66" COMPONENTS

|                       |                |                |       |      |    |    |    |    |
|-----------------------|----------------|----------------|-------|------|----|----|----|----|
| <b>388-1274GTA-43</b> | <b>\$2,055</b> | <b>\$2,261</b> | 138.9 | 6.27 | 73 | 12 | 43 | 43 |
|-----------------------|----------------|----------------|-------|------|----|----|----|----|

SHELL FOR 72" COMPONENTS

|                       |                |                |       |      |       |    |    |    |
|-----------------------|----------------|----------------|-------|------|-------|----|----|----|
| <b>388-1286GTA-43</b> | <b>\$2,271</b> | <b>\$2,498</b> | 160.9 | 7.26 | 84.75 | 12 | 43 | 43 |
|-----------------------|----------------|----------------|-------|------|-------|----|----|----|

SHELL FOR 84" COMPONENTS

- TRANSACTION TOP HAS 2" OVERHANG ON GUEST SIDE
- RAISED 1/2" DECORATIVE LAMINATE FRONT PANEL
- DEFAULT TWO-TONE FINISH FOR DECORATIVE PANEL I.E. ORDER GREY DUSK (GD) "TOP & BODY" WITH PURE WHITE (PW)"FACE" FOR TWO-TONE LOOK
- SEE WEBSITE FOR DESIGN CONCEPT IMAGES

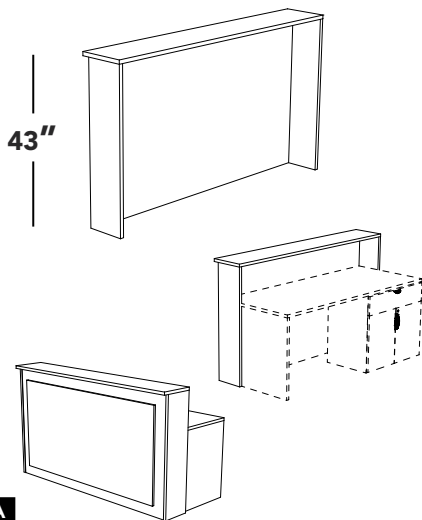

**RTA**

**GALLERY TRANSACTION SHELL - W/ HORIZONTAL CUBBIES (SURROUNDING SHELL)**

|                          |                |                |       |      |    |    |    |    |
|--------------------------|----------------|----------------|-------|------|----|----|----|----|
| <b>388-1268GTA-43-HC</b> | <b>\$2,332</b> | <b>\$2,565</b> | 141.1 | 5.78 | 67 | 12 | 43 | 43 |
|--------------------------|----------------|----------------|-------|------|----|----|----|----|

SHELL FOR 66" COMPONENTS

|                          |                |                |       |      |    |    |    |    |
|--------------------------|----------------|----------------|-------|------|----|----|----|----|
| <b>388-1274GTA-43-HC</b> | <b>\$2,556</b> | <b>\$2,812</b> | 154.3 | 6.27 | 73 | 12 | 43 | 43 |
|--------------------------|----------------|----------------|-------|------|----|----|----|----|

SHELL FOR 72" COMPONENTS

|                          |                |                |       |      |       |    |    |    |
|--------------------------|----------------|----------------|-------|------|-------|----|----|----|
| <b>388-1286GTA-43-HC</b> | <b>\$2,771</b> | <b>\$3,048</b> | 178.6 | 7.26 | 84.75 | 12 | 43 | 43 |
|--------------------------|----------------|----------------|-------|------|-------|----|----|----|

SHELL FOR 84" COMPONENTS

- TRANSACTION TOP HAS 2" OVERHANG ON GUEST SIDE
- RAISED 1/2" DECORATIVE LAMINATE FRONT PANEL
- DEFAULT TWO-TONE FINISH FOR DECORATIVE PANEL I.E. ORDER GREY DUSK (GD) "TOP & BODY" WITH PURE WHITE (PW)"FACE" FOR TWO-TONE LOOK
- SEE WEBSITE FOR DESIGN CONCEPT IMAGES
- 3" CUBBY CAVITY HEIGHT

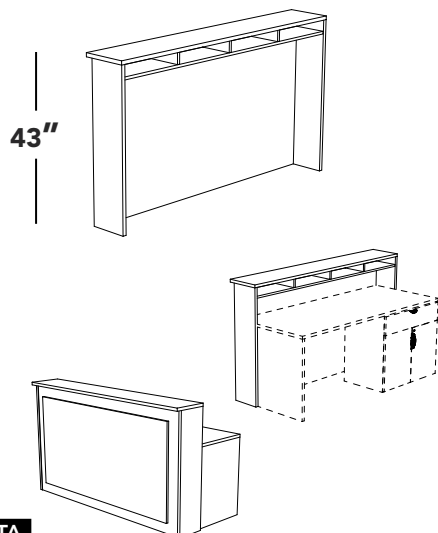

**RTA**



Heartwood's Outline Series is a stylish panel system which combines either Black (BL) or Aluminium (AL) finish rails and posts with your choice of panel. Add a transaction top to Outlines panels and you now have the perfect reception workstation. Have a specific look in mind....the numerous options available with Outlines are sure to meet your needs!

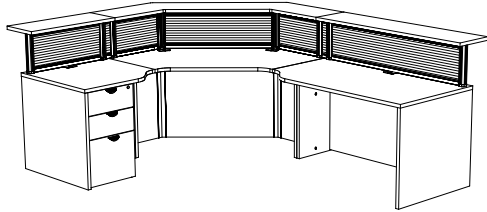

**For a complete list of Outlines products, please see page OUT- 1 of the Outlines Series in the Heartwood catalogue.**

- ♥ As with the Laminate Gallery options, neo-angle wedges and corner modules are also available on Outlines Series.
- ♥ Available in four panel materials:
  1. Plexiglass (PLX), in 3 styles - Clear (CL), Frosted (FR), or Bronze (BR).
  2. Ribbed Polycarbonate (PYP), which allows light to pass through but obscures visibility.
  3. Laminate (LAP), in 20 standard Heartwood finishes.
  4. Tackboard (TBP), in 12 standard Heartwood fabrics.
- ♥ Transaction tops available in all standard Heartwood Manufacturing finishes.

**NOTE:** Finishes and Fabric swatches can be found on the Heartwood Manufacturing web site at [www.heartwood.ca](http://www.heartwood.ca). Information is current at time of print but for up to date information check online.

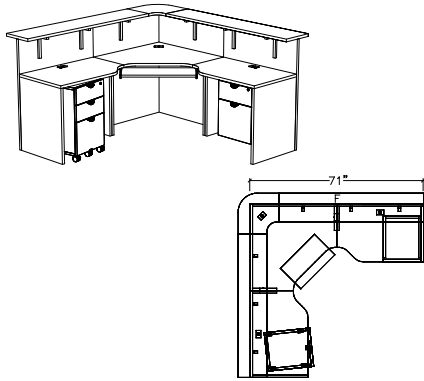

**LAYOUT #1**

|                          |  |                  |
|--------------------------|--|------------------|
| <b>388-2436LC-CR-AGC</b> | LEFT CONNECTOR - CUTBACK RIGHT W/ GALLERY BACK | <b>\$905</b>     |
| <b>388-1836CM-CGGC</b>   | GALLERY CORNER MODULE                          | <b>\$1,232</b>   |
| <b>388-2436RC-CL-CGA</b> | RIGHT CONNECTOR - CUTBACK LEFT W/ GALLERY BACK | <b>\$905</b>     |
| <b>388-1627MPUF</b>      | B/B/F MOBILE PEDESTAL                          | <b>\$965</b>     |
| <b>388-HPF</b>           | B/F HANGING PEDESTAL                           | <b>\$752</b>     |
| <b>388-1260GT</b>        | GALLERY TOP                                    | 2 x <b>\$290</b> |
| <b>388-17.517.5RCI</b>   | RADIUS CORNER INSERT                           | <b>\$335</b>     |
| <b>100-KD28</b>          | KEYBOARD DRAWER                                | <b>\$202</b>     |
| <b>TOTAL</b>             |  | <b>\$5,876</b>   |

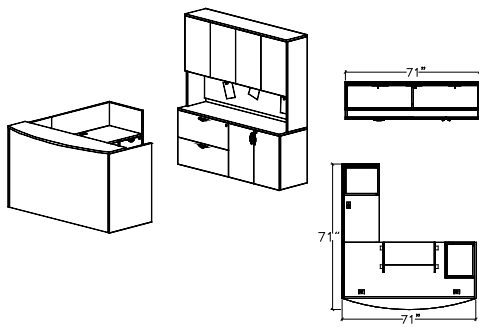

**LAYOUT #2**

|                    |                                   |                  |
|--------------------|-----------------------------------|------------------|
| <b>388-G3672DS</b> | GALLERY RECEPTION DESK SHELL      | <b>\$1,841</b>   |
| <b>388-G2442RS</b> | GALLERY RETURN SHELL - NON HANDED | <b>\$880</b>     |
| <b>388-HPF</b>     | B/F HANGING PEDESTAL              | 2 x <b>\$752</b> |
| <b>388-LF2072C</b> | LATERAL FILE/CABINET CREENZA      | <b>\$2,229</b>   |
| <b>388-4872HHD</b> | HUTCH W/ HINGED DOORS - 48" HIGH  | <b>\$2,276</b>   |
| <b>388-3672TB</b>  | TACKBOARD                         | <b>\$357</b>     |
| <b>100-KD28</b>    | KEYBOARD DRAWER                   | <b>\$202</b>     |
| <b>TOTAL</b>       |                                   | <b>\$9,289</b>   |

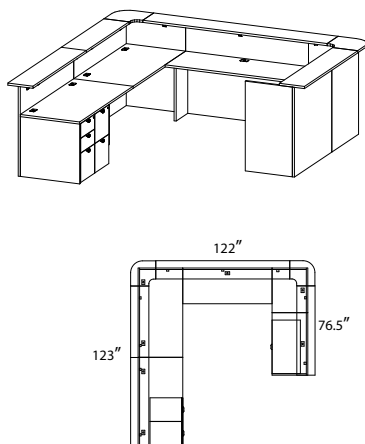

**LAYOUT #3**

|                        |                                |                  |
|------------------------|--------------------------------|------------------|
| <b>388-3060CT-AGC</b>  | GALLERY CONNECTOR - LEFT HAND  | <b>\$1,128</b>   |
| <b>388-3060CT-CGG</b>  | GALLERY CONNECTOR - RIGHT HAND | <b>\$1,205</b>   |
| <b>388-2460CT-CGC</b>  | GALLERY CONNECTOR - TALL BACK  | <b>\$1,003</b>   |
| <b>388-2430CT-GGC</b>  | GALLERY CONNECTOR - LEFT HAND  | <b>\$865</b>     |
| <b>388-2442CT-CGG</b>  | GALLERY CONNECTOR - RIGHT HAND | <b>\$956</b>     |
| <b>388-1260GT</b>      | GALLERY TOP                    | 2 x <b>\$290</b> |
| <b>388-1248GT</b>      | GALLERY TOP                    | <b>\$250</b>     |
| <b>388-17.517.5RCI</b> | RADIUS CORNER INSERT           | 2 x <b>\$335</b> |
| <b>388-1290GT</b>      | GALLERY TOP                    | <b>\$407</b>     |
| <b>388-1936LFX</b>     | LATERAL FILE - NO TOP          | <b>\$1,087</b>   |
| <b>388-19FPUF</b>      | FREESTANDING PEDESTAL - NO TOP | <b>\$871</b>     |
| <b>388-19FPFFX</b>     | FREESTANDING PEDESTAL - NO TOP | <b>\$939</b>     |
| <b>TOTAL</b>           |                                | <b>\$9,961</b>   |

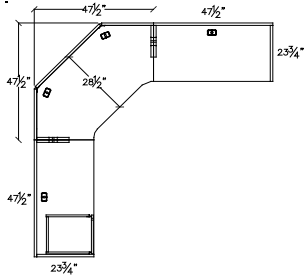
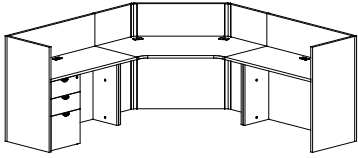

**LAYOUT #4**

|                       |                                 |     |                |
|-----------------------|---------------------------------|-----|----------------|
| <b>388-2448CT-GGC</b> | 24" GALLERY CONNECTOR           | 1 X | <b>\$1,006</b> |
| <b>388-2448CT-CGG</b> | 24" GALLERY CONNECTOR           | 1 X | <b>\$1,006</b> |
| <b>388-G2448NACM</b>  | GALLERY NEO-ANGLE CORNER MODULE | 1 X | <b>\$2,119</b> |
| <b>388-19FPUFX</b>    | FREESTANDING PEDESTAL - NO TOP  | 1 X | <b>\$871</b>   |
| <b>TOTAL</b>          |                                 |     | <b>\$5,002</b> |

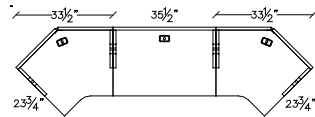
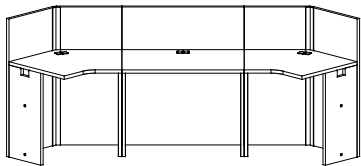

**LAYOUT #5**

|                       |                        |     |                |
|-----------------------|------------------------|-----|----------------|
| <b>388-G2424NACW</b>  | NEO-ANGLE CORNER WEDGE | 2 X | <b>\$1,341</b> |
| <b>388-2436CT-CGC</b> | 24" GALLERY CONNECTOR  | 1 X | <b>\$861</b>   |
| <b>TOTAL</b>          |                        |     | <b>\$3,543</b> |

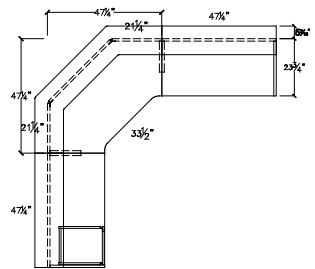
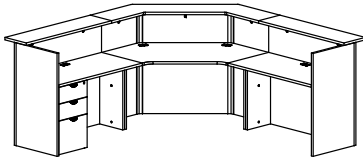

**LAYOUT #6**

|                       |                                   |     |                |
|-----------------------|-----------------------------------|-----|----------------|
| <b>388-2448CT-GGC</b> | 24" GALLERY CONNECTOR             | 1 X | <b>\$1,006</b> |
| <b>388-2448CT-CGG</b> | 24" GALLERY CONNECTOR             | 1 X | <b>\$1,006</b> |
| <b>388-G2448NACM</b>  | GALLERY NEO-ANGLE CORNER MODULE   | 1 X | <b>\$2,119</b> |
| <b>388-19FPUFX</b>    | FREESTANDING PEDESTAL - NO TOP    | 1 X | <b>\$871</b>   |
| <b>388-1248NAGT</b>   | NEO-ANGLE GALLERY TRANSACTION TOP | 1 X | <b>\$513</b>   |
| <b>388-1248GT</b>     | GALLERY TOP                       | 2 X | <b>\$250</b>   |
| <b>TOTAL</b>          |                                   |     | <b>\$6,015</b> |

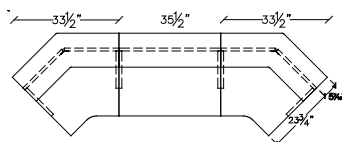
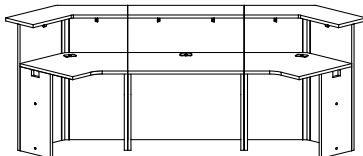

**LAYOUT #7**

|                       |   |     |                |
|-----------------------|---|-----|----------------|
| <b>388-G2424NACW</b>  | NEO-ANGLE CORNER WEDGE                  | 2 X | <b>\$1,341</b> |
| <b>388-2436CT-CGC</b> | 24" GALLERY CONNECTOR                   | 1 X | <b>\$861</b>   |
| <b>388-1236GT</b>     | GALLERY TOP                             | 1 X | <b>\$213</b>   |
| <b>388-1224NAGTW</b>  | NEO-ANGLE GALLERY WEDGE TRANSACTION TOP | 2 X | <b>\$377</b>   |
| <b>TOTAL</b>          |   |     | <b>\$4,510</b> |

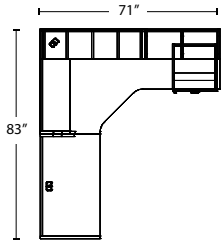
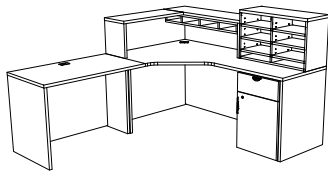

**LAYOUT #8**

|                      |                                     |                |
|----------------------|-------------------------------------|----------------|
| <b>388-1442CTA</b>   | CORNER TRANSACTION SHELF            | <b>\$571</b>   |
| <b>388-4272CM</b>    | CORNER MODULE EXTENDED RIGHT        | <b>\$1,421</b> |
| <b>388-1830DTO</b>   | DESKTOP ORGANIZER                   | <b>\$593</b>   |
| <b>388-4204HC</b>    | HORIZONTAL CUBBY-HOLE               | <b>\$361</b>   |
| <b>388-1918DCRHX</b> | CABINET - DRAWER OVER DOOR - NO TOP | <b>\$960</b>   |
| <b>388-2442CT-B</b>  | 24" CONNECTOR TOP                   | <b>\$638</b>   |
| <b>TOTAL</b>         |                                     | <b>\$4,544</b> |

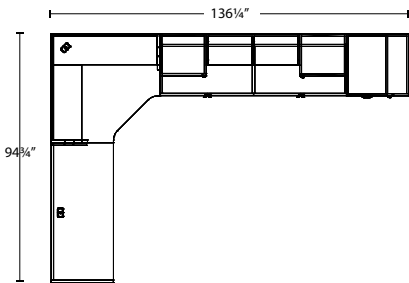
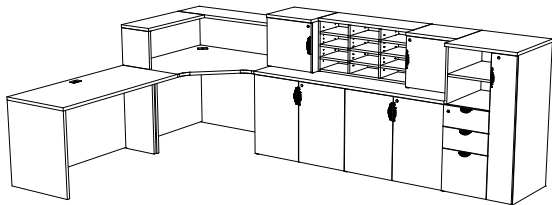

**LAYOUT #9**

|                         |                                  |                |
|-------------------------|----------------------------------|----------------|
| <b>388-C2472C</b>       | CABINET CREDENZA                 | <b>\$2,094</b> |
| <b>388-1818DTC-L</b>    | DESKTOP CABINET                  | <b>\$493</b>   |
| <b>388-1818DTC-R</b>    | DESKTOP CABINET                  | <b>\$493</b>   |
| <b>388-1836DTO</b>      | DESKTOP ORGANIZER                | <b>\$603</b>   |
| <b>388-4724OUFWR-24</b> | MID-HEIGHT OPEN WARDROBE STORAGE | <b>\$1,562</b> |
| <b>388-1442CTA</b>      | CORNER TRANSACTION SHELF         | <b>\$571</b>   |
| <b>388-2442CM-C</b>     | CORNER MODULE                    | <b>\$973</b>   |
| <b>388-2454CT-B</b>     | 24" CONNECTOR TOP                | <b>\$697</b>   |
| <b>TOTAL</b>            |                                  | <b>\$7,486</b> |

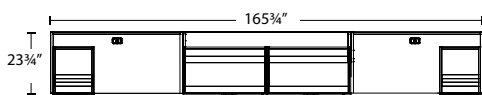
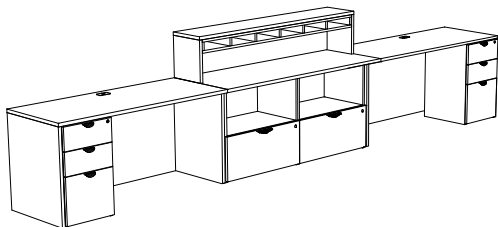

**LAYOUT #10**

|                     |                                    |                  |
|---------------------|------------------------------------|------------------|
| <b>388-2460FC</b>   | FILE CABINET TOP                   | <b>\$348</b>     |
| <b>388-2454CT-A</b> | 24" CONNECTOR TOP                  | 2 X <b>\$697</b> |
| <b>388-1460TA</b>   | TRANSACTION SHELF                  | <b>\$479</b>     |
| <b>388-6004HC</b>   | HORIZONTAL CUBBY-HOLE              | <b>\$405</b>     |
| <b>388-19FPUFX</b>  | FREESTANDING PEDESTAL - NO TOP     | 2 X <b>\$871</b> |
| <b>388-1930OLFX</b> | OPEN LATERAL FILE STORAGE - NO TOP | 2 X <b>\$900</b> |
| <b>TOTAL</b>        |                                    | <b>\$6,168</b>   |

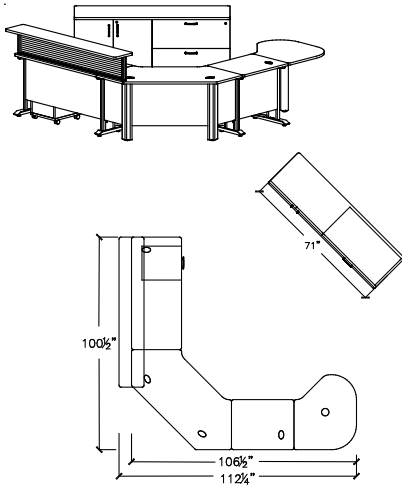

**LAYOUT #11**

|               |                          |     |                |
|---------------|--------------------------|-----|----------------|
| 850-2430EMT-L | END MEETING TABLE LEFT   |     | <b>\$474</b>   |
| 850-2430LC    | LEFT CONNECTOR           |     | <b>\$465</b>   |
| 850-2448NACM  | NEO-ANGLED CORNER MODULE |     | <b>\$1,078</b> |
| 850-2454RC    | RIGHT CONNECTOR          |     | <b>\$565</b>   |
| 850-MPUF      | MOBILE BBF PED           |     | <b>\$965</b>   |
| 850-2172TOP   | TOP ONLY                 |     | <b>\$317</b>   |
| 850-1936CX    | STORAGE CABINET - NO TOP |     | <b>\$831</b>   |
| 850-1936LFX   | NO TOP LATERAL FILE      |     | <b>\$1,036</b> |
| OUT-12POST    | OUTLINES POST PACKAGE    | 2 x | <b>\$94</b>    |
| OUT-1272PYP   | POLYCARBONATE PANEL      |     | <b>\$545</b>   |
| OUT1-1272TA   | STRAIGHT TRANSACTION TOP |     | <b>\$345</b>   |
| <b>TOTAL</b>  |                          |     | <b>\$6,809</b> |

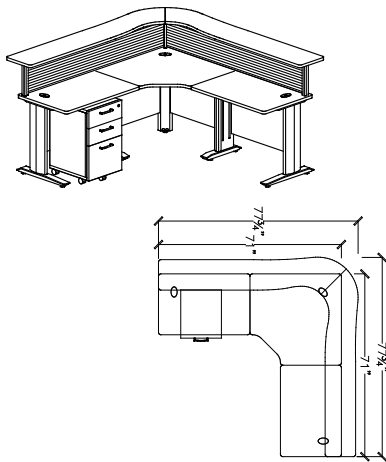

**LAYOUT #12**

|                 |                                       |     |                |
|-----------------|---------------------------------------|-----|----------------|
| 850-2436LC      | LEFT CONNECTOR                        |     | <b>\$497</b>   |
| 850-2436CM      | CORNER MODULE                         |     | <b>\$671</b>   |
| 850-2436RC      | RIGHT CONNECTOR                       |     | <b>\$497</b>   |
| 850-MPUF        | MOBILE BBF PED                        |     | <b>\$965</b>   |
| OUT-12POST      | OUTLINES POST PACKAGE                 | 3 x | <b>\$94</b>    |
| OUT-1272PYP     | POLYCARBONATE PANEL                   | 2 x | <b>\$545</b>   |
| OUT1-1272SCTA-L | SHAPED CORNER TRANSACTION TOP - LEFT  |     | <b>\$469</b>   |
| OUT1-1272SCTA-R | SHAPED CORNER TRANSACTION TOP - RIGHT |     | <b>\$469</b>   |
| <b>TOTAL</b>    |                                       |     | <b>\$4,940</b> |

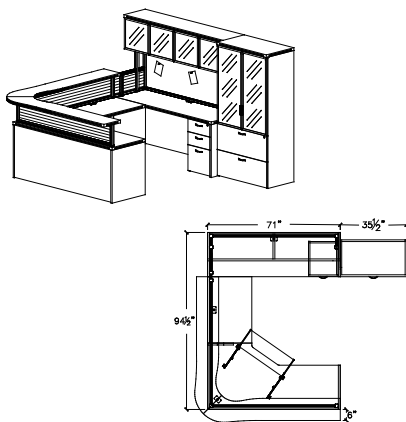

**LAYOUT #13**

|                     |                                    |    |                 |
|---------------------|------------------------------------|----|-----------------|
| OUT2-1272SCTA-L     | SHAPED CORNER TRANSACTION TOP - LT |    | <b>\$605</b>    |
| OUT2-1272SCTA-R     | SHAPED CORNER TRANSACTION TOP - RT |    | <b>\$605</b>    |
| 600-7236CM-B        | EXTENDED CORNER MODULE LEFT        |    | <b>\$1,332</b>  |
| 600-2436BR          | BRIDGE RETURN                      |    | <b>\$619</b>    |
| 600-2472CT-A        | 24" CONNECTOR TOP W/ A GABLES      |    | <b>\$913</b>    |
| OUT2-7036CLF-20-AGD | TALL CABINET OVER LATERAL FILE     |    | <b>\$2,678</b>  |
|                     | <i>AGD UPCHARGE</i>                |    | <b>\$854</b>    |
| OUT2-4172HHD-AGD    | HUTCH W/ ALUMINUM GLASS DOORS      |    | <b>\$1,574</b>  |
|                     | <i>AGD UPCHARGE</i>                |    | <b>\$893</b>    |
| OUT-1272PYP         | 12" POLYCARBONATE PANEL            | 2x | <b>\$545</b>    |
| OUT-12POST          | OUTLINES POST PACKAGE              | 4x | <b>\$94</b>     |
| OUT-1218PYP-F       | 12" POLYCARBONATE PANELS W/ FILLER |    | <b>\$206</b>    |
| OUT-2472TBP         | 24" TACKBOARD PANEL                |    | <b>\$586</b>    |
| OUT-12PYP-HFP       | POLYCARBONATE HUTCH FILLER PANELS  |    | <b>\$178</b>    |
| 600-19FPUF          | FREESTANDING PEDESTAL - NO TOP     |    | <b>\$871</b>    |
| 100-KD28            | KEYBOARD DRAWER                    |    | <b>\$202</b>    |
| <b>TOTAL</b>        |                                    |    | <b>\$13,582</b> |

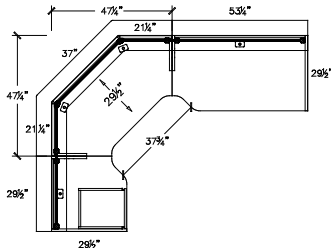
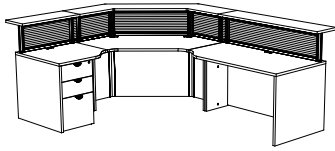

**LAYOUT #14**

|                  |                                       |     |                |
|------------------|---------------------------------------|-----|----------------|
| 388-3030LC-CR    | 30" LEFT CONNECTOR, CUTBACK RIGHT     |     | <b>\$683</b>   |
| 388-2448NACM     | NEO-ANGLE CORNER MODULE               |     | <b>\$1,325</b> |
| 388-3054RC-CL    | 30" RIGHT CONNECTOR, CUTBACK LEFT     |     | <b>\$814</b>   |
| 388-19FPUFX      | FREESTANDING PEDESTAL - NO TOP        |     | <b>\$871</b>   |
| OUT-12POST       | OUTLINES POST PACKAGE                 | 8 x | <b>\$94</b>    |
| OUT-1230PYP-F    | 12" POLYCARBONATE PANEL               |     | <b>\$240</b>   |
| OUT-1254PYP-F    | 12" POLYCARBONATE PANEL               |     | <b>\$414</b>   |
| OUT-1248PYP-NAPS | 12" POLYCARBONATE NEO-ANGLE PANEL SET |     | <b>\$719</b>   |
| OUT1-1254TA      | TRANSACTION TOP                       |     | <b>\$277</b>   |
| OUT1-1248NATA    | NEO-ANGLE TRANSACTION TOP             |     | <b>\$534</b>   |
| OUT1-1230TA      | TRANSACTION TOP                       |     | <b>\$166</b>   |
| <b>TOTAL</b>     |                                       |     | <b>\$6,795</b> |

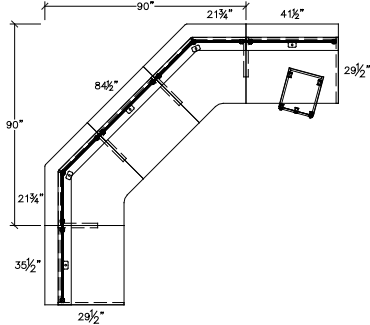
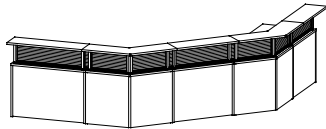
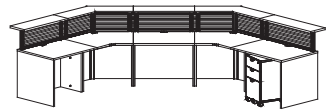

**LAYOUT #15**

|                     |                                     |      |                |
|---------------------|-------------------------------------|------|----------------|
| 388-3030NACW        | NEO-ANGLE CORNER WEDGE              | 2 x  | <b>\$1,059</b> |
| 388-3036CT-C        | 30" CONNECTOR TOP                   |      | <b>\$683</b>   |
| 388-3042CT-B        | 30" CONNECTOR TOP                   |      | <b>\$711</b>   |
| 388-3036CT-B        | 30" CONNECTOR TOP                   |      | <b>\$683</b>   |
| 388-1627MPUF        | MOBILE PEDESTAL                     |      | <b>\$965</b>   |
| OUT-1230PYP-NAWPS-F | NEO-ANGLE WEDGE PANEL SET W/ FILLER | 2 x  | <b>\$505</b>   |
| OUT-1236PYP         | 12" POLYCARBONATE PANEL             | 2 x  | <b>\$289</b>   |
| OUT-1242PYP         | 12" POLYCARBONATE PANEL             |      | <b>\$323</b>   |
| OUT1-1230NATAW      | NEO-ANGLE WEDGE TRANSACTION         | 2 x  | <b>\$419</b>   |
| OUT1-1236TA         | STRAIGHT TRANSACTION TOP            | 2 x  | <b>\$179</b>   |
| OUT1-1242TA         | STRAIGHT TRANSACTION TOP            |      | <b>\$223</b>   |
| OUT-12POST          | OUTLINES POST PACKAGE               | 12 x | <b>\$94</b>    |
| <b>TOTAL</b>        |                                     |      | <b>\$9,618</b> |

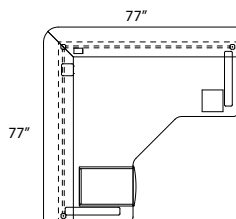
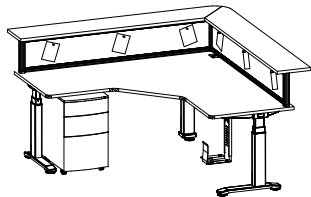

**LAYOUT #16**

|                   |                                     |     |                |
|-------------------|-------------------------------------|-----|----------------|
| CAL-E1-3LEG       | HEIGHT ADJUSTABLE 3 LEG BASE        |     | <b>\$1,988</b> |
| CAL-3072-7230CMLD | ONE PIECE L-SHAPED TOP              |     | <b>\$1,443</b> |
| OUT-12POST        | OUTLINES POST PACKAGE               | 3 x | <b>\$94</b>    |
| OUT-1272TBP       | 12" TACK BOARD PANELS               | 2 x | <b>\$482</b>   |
| OUT1-1272CTA-L    | CORNER TRANSACTION TOP - LEFT       |     | <b>\$435</b>   |
| OUT1-1272CTA-R    | CORNER TRANSACTION TOP - RIGHT      |     | <b>\$435</b>   |
| 100-MMPUF         | METAL MOBILE PEDESTAL - FULL CARTON |     | <b>\$540</b>   |
| 100-2-HCPU        | HANGING CPU HOLDER                  |     | <b>\$188</b>   |
| <b>TOTAL</b>      |                                     |     | <b>\$6,275</b> |

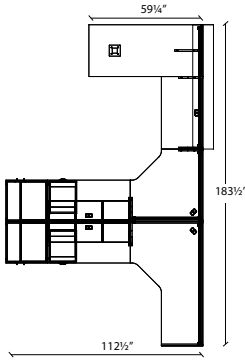
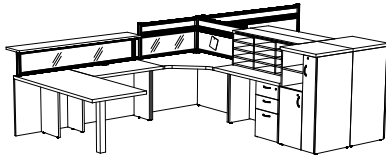

\*\*LAYOUT SHOWS 600 SERIES TOPS WITH NON-FLUTED EDGE. PLEASE INDICATED ON YOUR PO IF FLUTING IS **NOT** REQUIRED

**LAYOUT #17 (SHOWN IN 600 SERIES BROCHURE)**

|                  |  |    |                 |
|------------------|--|----|-----------------|
| 600-3060RBTG     | RECTANGULAR BULLET TOP W/ FULL GABLE & 3" SQUARE LEG |    | <b>\$937</b>    |
| 600-2442CT-C     | 24" CONNECTOR TOP                                    |    | <b>\$727</b>    |
| 600-2442CM-C     | CORNER MODULE  |    | <b>\$1,109</b>  |
| 600-2448CT-B     | 24" CONNECTOR TOP                                    | X2 | <b>\$766</b>    |
| 600-19FPUFX      | FREESTANDING PEDESTAL - NO TOP                       | X2 | <b>\$871</b>    |
| 600-4724OCWR-24  | OPEN SHELF/CABINET/WARDROBE RIGHT                    |    | <b>\$1,538</b>  |
| 600-4724OCWL-24  | OPEN SHELF/CABINET/WARDROBE LEFT                     |    | <b>\$1,538</b>  |
| 600-4272CM-B     | CORNER MODULE EXTENDED RIGHT                         |    | <b>\$1,620</b>  |
| 600-1848DTO      | DESKTOP ORGANIZER                                    | X2 | <b>\$737</b>    |
| OUT-1272PLX-F-FR | 12" PLEXIGLASS PANEL W/ FILLER                       | X2 | <b>\$555</b>    |
| OUT-1242PLX-FR   | 12" PLEXIGLASS PANEL                                 |    | <b>\$325</b>    |
| OUT-1242TBP      | 12" TACKBOARD PANEL                                  |    | <b>\$338</b>    |
| OUT-0642PLX-CL   | 6" TOP PANEL CLEAR                                   | X2 | <b>\$325</b>    |
| OUT-0672PLX-F-CL | 6" TOP PANEL CLEAR W/ FILLER                         |    | <b>\$555</b>    |
| OUT-12POST-BL    | POST PACKAGE   | X2 | <b>\$94</b>     |
| OUT-18POST-BL    | POST PACKAGE   | X5 | <b>\$113</b>    |
| OUT2-1272TA      | 1 1/2" TRANSACTION TOPS                              |    | <b>\$443</b>    |
| TOTAL            |  |    | <b>\$16,391</b> |

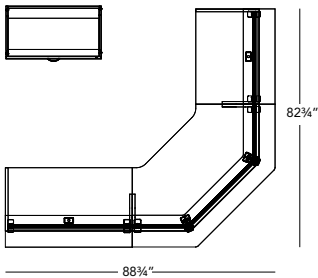
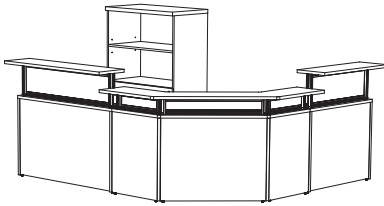

**LAYOUT #18 (SHOWN IN 388 SERIES BROCHURE)**

|                   |                                |    |                |
|-------------------|--------------------------------|----|----------------|
| OUT-648PLX-NAPS-F | NEO-ANGLE CORNER PANEL SETS    |    | <b>\$834</b>   |
| OUT1-1248NATA     | NEO-ANGLE TRANSACTION TOPS     |    | <b>\$534</b>   |
| 388-2448NACM      | NEO-ANGLE CORNER MODULE        |    | <b>\$1,325</b> |
| OUT-1236PLX       | 12" PLEXIGLASS PANEL           |    | <b>\$299</b>   |
| OUT-1248PLX       | 12" PLEXIGLASS PANEL           |    | <b>\$400</b>   |
| OUT1-1236TA       | STRAIGHT TRANSACTION TOP       |    | <b>\$179</b>   |
| OUT1-1248TA       | STRAIGHT TRANSACTION TOP       |    | <b>\$234</b>   |
| OUT-12POST        | OUTLINES POST PACKAGE          | X4 | <b>\$94</b>    |
| OUT-6POST         | 6" OUTLINES POST PACKAGE       | X4 | <b>\$94</b>    |
| 388-2448CT-B      | 24" CONNECTOR TOP              |    | <b>\$672</b>   |
| 388-2436CT-B      | 24" CONNECTOR TOP              |    | <b>\$615</b>   |
| 388-2436O2LF4     | OPEN TALL LATERAL FILE STORAGE |    | <b>\$2,185</b> |
| TOTAL             |                                |    | <b>\$8,029</b> |

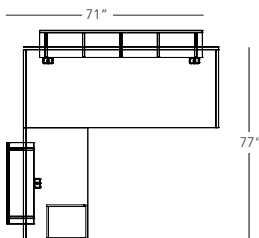
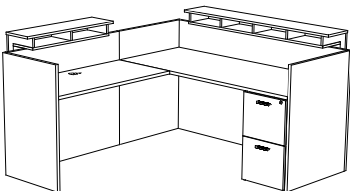

**LAYOUT #19**

|              |   |  |                |
|--------------|---|--|----------------|
| 388-3672MGDS | MODERN RECEPTION DESK                   |  | <b>\$2,981</b> |
| 388-3042MGRS | NON-HANDED MODERN RECEPTION DESK RETURN |  | <b>\$1,471</b> |
| 388-19FPPFX  | FREESTANDING PEDESTAL - NO TOP          |  | <b>\$939</b>   |
| TOTAL        |   |  | <b>\$5,391</b> |

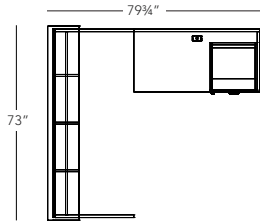
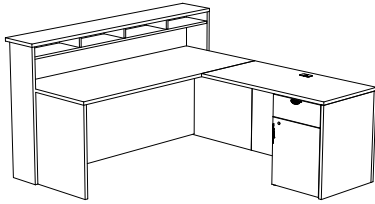

**LAYOUT #20**

|                          |                                      |                |
|--------------------------|--------------------------------------|----------------|
| <b>388-1274GTA-43-HC</b> | GALLERY TRANSACTION SHELL W/ CUBBIES | <b>\$2,556</b> |
| <b>388-3072DS</b>        | DESK SHELL                           | <b>\$878</b>   |
| <b>388-2448RS</b>        | NON-HANDED RETURN SHELL              | <b>\$655</b>   |
| <b>388-1918DCRHX</b>     | CABINET - DRAWER OVER DOOR - NO TOP  | <b>\$960</b>   |
| <b>TOTAL</b>             |                                      | <b>\$5,049</b> |

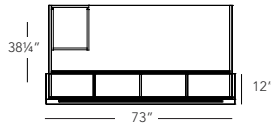
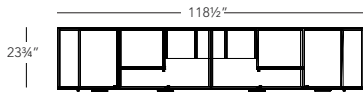
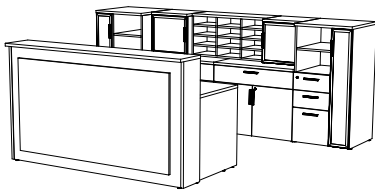

**LAYOUT #21**

|                          |   |                   |
|--------------------------|---|-------------------|
| <b>388-1274GTA-43-HC</b> | GALLERY TRANSACTION SHELL W/ CUBBIES          | <b>\$2,556</b>    |
| <b>388-3672DS</b>        | DESK SHELL                                    | <b>\$1,077</b>    |
| <b>388-HPF</b>           | HANGING PEDESTAL                              | <b>\$752</b>      |
| <b>388-1836DTO</b>       | DESKTOP ORGANIZER                             | <b>\$603</b>      |
| <b>388-1818DTC-L-AGD</b> | DESKTOP CABINET - HINGED LEFT WITH AGD DOORS  | <b>\$493</b>      |
|                          | <i>AGD UPCHARGE</i>                           | <b>\$270</b>      |
| <b>388-1818DTC-R-AGD</b> | DESKTOP CABINET - HINGED RIGHT WITH AGD DOORS | <b>\$493</b>      |
|                          | <i>AGD UPCHARGE</i>                           | <b>\$270</b>      |
| <b>388-2436WDC</b>       | CABINET - WIDE DRAWER OVER 2 DOOR CABINET     | X2 <b>\$1,373</b> |
| <b>388-4724OUFWL-24</b>  | MID-HEIGHT OPEN WARDROBE STORAGE              | <b>\$1,562</b>    |
|                          | <i>AGD UPCHARGE</i>                           | <b>\$544</b>      |
| <b>388-4724OUFWR-24</b>  | MID-HEIGHT OPEN WARDROBE STORAGE              | <b>\$1,562</b>    |
|                          | <i>AGD UPCHARGE</i>                           | <b>\$544</b>      |
| <b>TOTAL</b>             |   | <b>\$13,472</b>   |

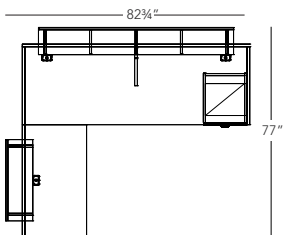
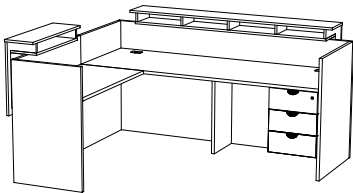

**LAYOUT #22**

|                       |   |                |
|-----------------------|---|----------------|
| <b>388-3684MGDS+C</b> | MODERN RECEPTION DESK MODERN RECEPTION DESK | <b>\$3,218</b> |
| <b>388-3042MGRS</b>   | NON-HANDED MODERN RECEPTION DESK RETURN     | <b>\$1,471</b> |
| <b>388-HPU</b>        | FREESTANDING PEDESTAL - NO TOP              | <b>\$753</b>   |
| <b>TOTAL</b>          |   | <b>\$5,442</b> |



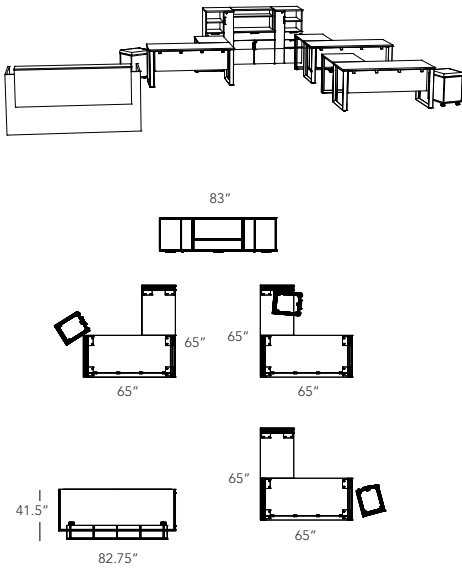

**LAYOUT #23**

|                         |   |    |                 |
|-------------------------|---|----|-----------------|
| <b>388-3684MGDS+C</b>   | MODERN RECEPTION DESK                     |    | <b>\$3,218</b>  |
| <b>FLXS-REC3066</b>     | 30" RECTANGLE TOPS                        | X3 | <b>\$414</b>    |
| <b>FLXS-REC2436</b>     | 24" RECTANGLE TOP                         | X3 | <b>\$204</b>    |
| <b>900-LOOP24</b>       | 24" METAL LOOP LEG                        | X3 | <b>\$188</b>    |
| <b>900-LOOP30</b>       | 30" METAL LOOP LEG                        | X6 | <b>\$207</b>    |
| <b>LEV-1466LMPS</b>     | LAMINATE MODESTY PANELS                   | X3 | <b>\$262</b>    |
| <b>388-1622MPF</b>      | MOBILE B/F PEDESTAL                       | X3 | <b>\$834</b>    |
| <b>WRK-MPEDCUSH-ESC</b> | USE ON 21" HIGH MOBILE PEDESTALS          | X3 | <b>\$393</b>    |
| <b>388-4724OUFWL-24</b> | MID-HEIGHT OPEN WARDROBE STORAGE          |    | <b>\$1,562</b>  |
| <b>388-4724OUFWR-24</b> | MID-HEIGHT OPEN WARDROBE STORAGE          |    | <b>\$1,562</b>  |
| <b>388-2436WDC</b>      | CABINET - WIDE DRAWER OVER 2 DOOR CABINET |    | <b>\$1,373</b>  |
| <b>388-1836DTS</b>      | DESKTOP OPEN STORAGE                      |    | <b>\$638</b>    |
| <b>TOTAL</b>            |   |    | <b>\$16,480</b> |

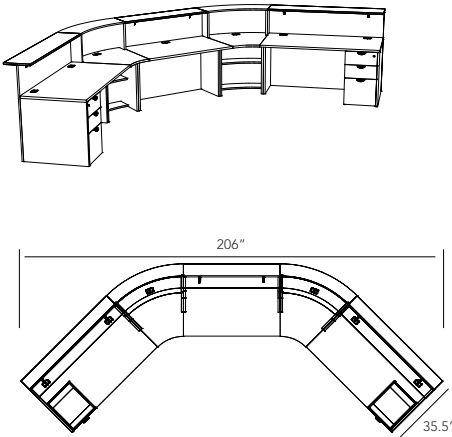

**LAYOUT #24**

|                        |  |    |                 |
|------------------------|--|----|-----------------|
| <b>388-3060GCT-AGC</b> | GALLERY CONNECTOR                            |    | <b>\$2,163</b>  |
| <b>388-3627GCVRCW</b>  | GALLERY CURVED RECEPTION CORNER MODULE WEDGE | X2 | <b>\$3,516</b>  |
| <b>388-3048GCT-CGC</b> | GALLERY CONNECTOR                            |    | <b>\$2,101</b>  |
| <b>388-3060GCT-CGA</b> | GALLERY CONNECTOR                            |    | <b>\$2,163</b>  |
| <b>388-1260MGT</b>     | STRAIGHT GALLERY TOP                         | X2 | <b>\$473</b>    |
| <b>388-1248MGT</b>     | STRAIGHT GALLERY TOP                         |    | <b>\$413</b>    |
| <b>388-19FPUFX</b>     | FREESTANDING PEDESTAL - NO TOP               | X2 | <b>\$871</b>    |
| <b>TOTAL</b>           |  |    | <b>\$16,560</b> |

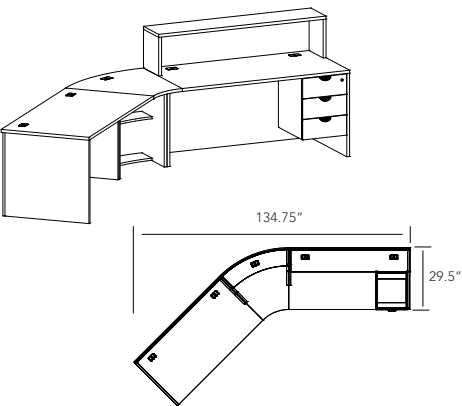

**LAYOUT #25**

|                       |  |  |                |
|-----------------------|--|--|----------------|
| <b>388-3060CT-ATC</b> | DESK HEIGHT CONNECTORS                           |  | <b>\$995</b>   |
| <b>388-3024CVRCW</b>  | DESK HEIGHT CURVED RECEPTION CORNER MODULE WEDGE |  | <b>\$3,583</b> |
| <b>388-3060CT-CTA</b> | DESK HEIGHT CONNECTORS                           |  | <b>\$995</b>   |
| <b>388-1460TA</b>     | TRANSACTION SHELF                                |  | <b>\$479</b>   |
| <b>388-HPU</b>        | HANGING PEDESTAL - BOX/BOX/BOX                   |  | <b>\$753</b>   |
| <b>TOTAL</b>          |  |  | <b>\$6,805</b> |

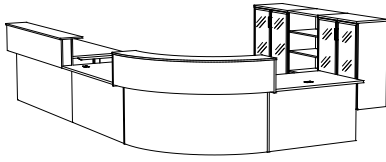

**LAYOUT #26**

|                            |  |                   |
|----------------------------|--|-------------------|
| <b>388-OH3648CT-ATC</b>    | DESK HEIGHT CONNECTOR TOP WITH OVERHANG                | <b>\$924</b>      |
| <b>388-3654MGCVCM</b>      | GALLERY CURVED RECEPTION CORNER MODULE WITH WATERFALL  | <b>\$4,689</b>    |
| <b>388-OH3660CT-CTC</b>    | DESK HEIGHT CONNECTOR TOP WITH OVERHANG                | <b>\$995</b>      |
| <b>388-HPU</b>             | HANGING PEDESTAL - BOX/BOX/BOX                         | <b>\$753</b>      |
| <b>388-3676MGCT-HA-CGA</b> | GALLERY CONNECTOR WITH WATERFALL FOR HEIGHT ADJUSTABLE | <b>\$2,601</b>    |
| <b>CAL-REC3072</b>         | 30" RECTANGLE TOP                                      | <b>\$453</b>      |
| <b>ATH-E1-2LEG</b>         | ATHENA 2 LEG BASE                                      | <b>\$1060</b>     |
| <b>388-4736C-20-AGD</b>    | MID-HEIGHT CABINET                                     | <b>X2 \$1,358</b> |
|                            | <i>AGD UPCHARGE</i>                                    | <b>X2 \$1,019</b> |
| <b>388-4730CO-20</b>       | OPEN MID-HEIGHT CABINET                                | <b>\$1,158</b>    |
| <b>TOTAL</b>               |  | <b>\$17,387</b>   |

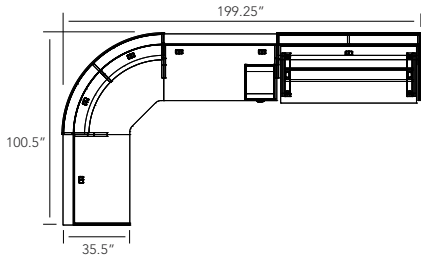

# 850 SERIES

This is a metric series (imperial sizing available). Please refer to page [INDEX-1](#) for details

|  |        |
|--|--------|
| <b>Series Specifications &amp; Description</b> ..... | 850-3  |
| <b>Product by Category</b> .....                     |        |
| <b>Desks</b> .....                                   |        |
| Straight, Bowtop & Corner Desks .....                | 850-5  |
| <b>Credenzas</b> .....                               | 850-7  |
| <b>Storage Cabinets</b> .....                        | 850-8  |
| <b>Connectors</b> .....                              | 850-9  |
| <b>Corner Modules</b> .....                          | 850-11 |
| Extended Corner Modules .....                        | 850-11 |
| Angled Corners .....                                 | 850-12 |
| <b>Tops</b> .....                                    |        |
| Transition Tops .....                                | 850-12 |
| Peninsula Tops .....                                 | 850-13 |
| Bullet Tops .....                                    | 850-13 |
| <b>Drawer Pedestals</b> .....                        | 850-15 |
| <b>Hutches &amp; Accessories</b> .....               |        |
| Hutches .....  | 850-16 |
| Hutch Backs .....                                    | 850-17 |
| Corner Hutches .....                                 | 850-18 |
| Tackboards .....                                     | 850-18 |
| <b>Tall Storage</b> .....                            | 850-19 |
| <b>850 Series Layouts</b> .....                      | 850-21 |



## Features

- ♥ Flexibility, style, function and...durability
- ♥ Over 190 components and ~20 finishes to choose from
- ♥ Solid colour, woodgrain or two tone combinations available
- ♥ Built-in wire management with silver elliptical grommets in tops

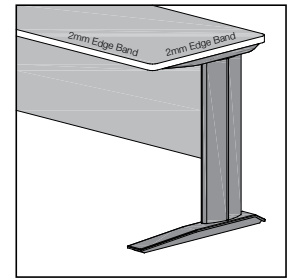

## Finishes

| LAMINATES | SUITABLE FOR        |                 |          | DEFAULT FINISHES |               |                            |              |                           |
|-----------|---------------------|-----------------|----------|------------------|---------------|----------------------------|--------------|---------------------------|
|           | ABBR                | LAMINATE COLOUR | TOPS     | BASE             | MATCHING EDGE | HANDLES (BRIDGE ALUMINIUM) | LOCK (BLACK) | GROMMET (GREY ELLIPTICAL) |
| AM        | Autumn Maple        | ✓               | ✓        | ✓                |               | ✓                          | ✓            | ✓                         |
| BL        | Black               | X               | ✓        | ✓                |               | ✓                          | ✓            | ✓                         |
| BW        | Black Walnut        | ✓               | ✓        | ✓                |               | ✓                          | ✓            | ✓                         |
| CD        | Cappuccino Dream ** | ✓               | ✓        | ✓                |               | ✓                          | ✓            | ✓                         |
| CM        | Charcoal Matrix     | ✓               | ✓        | Black            |               | ✓                          | ✓            | ✓                         |
| DE        | Desert Sand         | ✓               | ✓        | ✓                |               | ✓                          | ✓            | ✓                         |
| DD        | Driftwood***        | ✓               | ✓ (1")   | ✓                |               | ✓                          | ✓            | ✓                         |
| DW        | Driftwood Grey**    | (n/a)           | ✓ (3/4") | ✓                |               | ✓                          | ✓            | (n/a)                     |
| EZ        | Evening Zen         | ✓               | ✓        | ✓                |               | ✓                          | ✓            | ✓                         |
| GA        | Golden Ash          | ✓               | ✓        | ✓                |               | ✓                          | ✓            | ✓                         |
| GD        | Grey Dusk           | ✓               | ✓        | ✓                |               | ✓                          | ✓            | ✓                         |
| GM        | Grey Matrix         | ✓               | ✓        | Grey             |               | ✓                          | ✓            | ✓                         |
| GR        | Grey                | ✓               | ✓        | ✓                |               | ✓                          | ✓            | ✓                         |
| GT        | Graphite            | X               | ✓        | ✓                |               | ✓                          | ✓            | ✓                         |
| HM        | Hardrock Maple      | ✓               | ✓        | ✓                |               | ✓                          | ✓            | ✓                         |
| NC        | Noce Cocoa          | ✓               | ✓        | ✓                |               | ✓                          | Silver       | ✓                         |
| PW        | Pure White          | ✓               | ✓        | ✓                |               | ✓                          | Silver       | ✓                         |
| RM        | Royal Mahogany      | ✓               | ✓        | ✓                |               | ✓                          | ✓            | ✓                         |
| SM        | Sugar Maple         | ✓               | ✓        | ✓                |               | ✓                          | ✓            | ✓                         |
| SW        | Seaside White       | ✓               | ✓        | ✓                |               | ✓                          | Silver       | ✓                         |
| VA        | Volcanic Ash        | ✓               | ✓        | ✓                |               | ✓                          | ✓            | ✓                         |
| WW        | Winter Wood         | ✓               | ✓        | ✓                |               | ✓                          | Silver       | ✓                         |

\*\*Textured Finish

\*\*\* Non-textured Finish 1" & 1½" only

High Pressure (HP) laminate available. Contact Customer Service.

## Construction

- ♥ Tops are 1" thick, (1½" available, contact customer service for pricing).
- ♥ Modesty panels, door and drawer fronts are ¾" thick.
- ♥ 850 Series - all corners of work surface tops have 1½" radius.
- ♥ 840 Series - Square corners are available as alternative to radius. Change sku to **840** and use same price.  
> **Ordering Example: 840-3672DS**
- ♥ All wood product parts have thermally fused laminate on a 45 lb. industrial particle board core.
- ♥ Leveling glides are standard on all floor units.

## Edge Detail

- ♥ Banding changes to an alternate Heartwood standard colour are available at no extra charge.
- ♥ Edges all finished in a matching 2mm edge band.

## Modesty panels

- ♥ All modesty panels are ¾" thick.
- ♥ Default height is ¾ which is 7½" up off of the floor. Full and half modesty panels are available on request, contact customer service.
- ♥ Modesty panels are recessed 4" on all floor units except 36" deep desk shells where it is an 8" recess.

## Metal Components

- ♥ Base legs and hutch columns are powder coated steel in Titanium finish.

## Drawers

- ♥ Laminate units
- ♥ All drawers are 5 pieces - 4 x 1/2" black sides & 1 x 1/8" black bottom.
- ♥ All drawers and doors have handles except hutch doors. Hutch door handles may be added by request for an up-charge of **\$38** per handle. See page **100-3** for selection details.
- ♥ All box and file drawers mounted on full extension ball bearing slides, 100 lb. load rating.
- ♥ Lateral file drawers mounted on full extension ball bearing slides, 150 lb. Load rating.
- ♥ One pencil tray included with every box drawer unit.

**Note:** all file and lateral file drawers are constructed to support hanging file folders.

Broken drawer bottoms are not covered by warranty. If you expect to store heavy items, ie. Phone books, paper etc. on the drawer bottom, we offer an optional 1/2" bottom for these drawers. Please contact customer service for pricing.

## Glazed Doors and Panels

- ♥ All glazed doors and panels consist of an aluminum frame with a 5mm plexiglass panel.
- ♥ The prices shown for aluminum frame glazed doors is an upcharge and must be added to the base price of the unit it goes on.
- ♥ AGD doors are not locking by default, add -L to the SKU and upcharge of **\$76**
- ♥ Doors include silver finish, bar handles (except on hutches & overheads which do not need handles).
- ♥ Frames have a natural, brushed aluminum finish.
- ♥ HML AGD doors differ from HDL and will not match if paired together.
- ♥ Plexiglass panels are available in 3 styles...
  - > Clear (CL)
  - > Frosted (FR)
  - > Bronze (BR)

Please indicate on your PO which plexiglass style you would like.

## Locks

- ♥ All tall cabinet and storage cabinet laminate doors and drawers lock, **except where noted in price book.**
  - ♥ To add an optional lock to a component or Aluminum Glazed Doors (AGD), add -L to the SKU and upcharge of **\$76**
  - ♥ Hutch & overhead storage doors do not lock, unless requested. There is a **\$76** upcharge.
  - ♥ Core removable locks are standard on all drawer pedestals, lateral files and storage cabinets.
    - > For keyed-alike locks, indicate on your order, which standard units you would like keyed-alike.
    - > Order the appropriate quantity of like numbered cores required at **\$11** Each.
- Ordering Example:** if you require 3 units to be keyed alike, **order 100-COREPACK-3 (\$11 x 3 = \$33).**

## Optional Boot Shelves:

- ♥ All tall wardrobe storage & storage cabinets can have an optional boot shelf. Upcharges apply when ordering bootshelf: add -BS to product SKU.
  - > **Ordering Example:** 850-7024CLC-L-24-BS

| Bootshelf Upcharges |              |
|---------------------|--------------|
| 12"w to 23"w        | <b>\$119</b> |
| 24"w to 35"w        | <b>\$134</b> |
| 36"w or >           | <b>\$174</b> |

## Accessories

- ♥ See 100 series (ACC Page **100-1**) for a complete list of keyboard trays, pencil drawers, grommets, task lighting, CPU holders, etc.

### Custom sizes

- ♥ Custom available.....call customer service. Please specify quote number when ordering.

- ♥ Custom widths available

> For simple width changes, use the price of the next model size up.

> **Ordering Example:** for the price of a **850-2766ds**

Take the price of **the next larger size...850-3066DS - \$676**

**Note:** If doors, drawers or height are involved, or if there is no next size up, please contact customer service for a quote.

## Shipping

- ♥ Some items are shipped fully assembled, some are shipped in RTA cartoning.  
Look for rta symbol **RTA** at each model number.

**NOTE:** Information is current at time of print. For up to date information check online at [www.heartwood.ca](http://www.heartwood.ca).

| MODEL | LIST | WEIGHT | CUBE            | W  | D  | H  |
|-------|------|--------|-----------------|----|----|----|
|       |      | LBS    | FT <sup>3</sup> | IN | IN | IN |

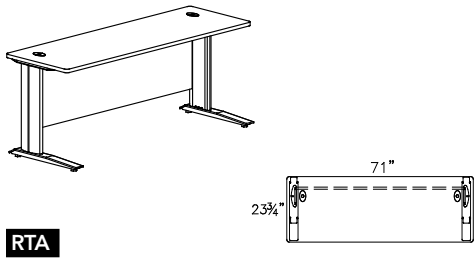

**RTA**

**24" DESK SHELL**

INCLUDES 2 - 24" END LEGS

|            |       |    |     |       |       |    |
|------------|-------|----|-----|-------|-------|----|
| 850-2448DS | \$541 | 71 | 2.7 | 47.25 | 23.75 | 29 |
| 850-2454DS | \$565 | 78 | 2.9 | 53.25 | 23.75 | 29 |
| 850-2460DS | \$578 | 85 | 3.1 | 59.25 | 23.75 | 29 |
| 850-2466DS | \$612 | 92 | 3.3 | 65    | 23.75 | 29 |
| 850-2472DS | \$647 | 98 | 3.4 | 71    | 23.75 | 29 |

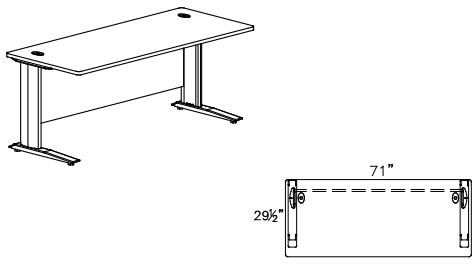

**RTA**

**30" DESK SHELL**

INCLUDES 2 - 30" END LEGS

|            |       |     |     |       |      |    |
|------------|-------|-----|-----|-------|------|----|
| 850-3048DS | \$593 | 76  | 3.2 | 47.25 | 29.5 | 29 |
| 850-3054DS | \$632 | 83  | 3.4 | 53.25 | 29.5 | 29 |
| 850-3060DS | \$649 | 95  | 3.6 | 59.25 | 29.5 | 29 |
| 850-3066DS | \$676 | 102 | 3.8 | 65    | 29.5 | 29 |
| 850-3072DS | \$710 | 109 | 4   | 71    | 29.5 | 29 |

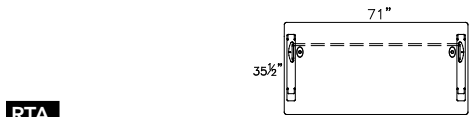

**RTA**

**36" DESK SHELL**

INCLUDES 2 - 30" END LEGS

|            |       |     |     |    |      |    |
|------------|-------|-----|-----|----|------|----|
| 850-3672DS | \$871 | 125 | 4.6 | 71 | 35.5 | 29 |
|------------|-------|-----|-----|----|------|----|

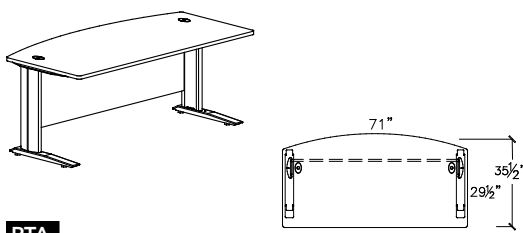

**RTA**

**BOWTOP 36" DESK SHELL**

INCLUDES 2 - 30" END LEGS

|             |       |     |     |    |      |    |
|-------------|-------|-----|-----|----|------|----|
| 850-B3672DS | \$962 | 117 | 4.6 | 71 | 35.5 | 29 |
|-------------|-------|-----|-----|----|------|----|

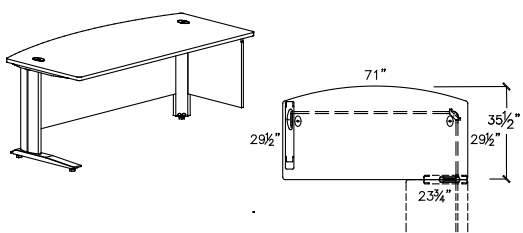

**RTA**

**BOWTOP 36" CORNER DESK LEFT - CAN NOT STAND ALONE**

INCLUDES 30" END LEG & CORNER LEG - BACK & LEFT SIDE MODESTY PANEL  
RETURN CONNECTS TO RIGHT FRONT

|              |         |     |     |    |      |    |
|--------------|---------|-----|-----|----|------|----|
| 850-B3672CDL | \$1,221 | 117 | 4.6 | 71 | 35.5 | 29 |
|--------------|---------|-----|-----|----|------|----|

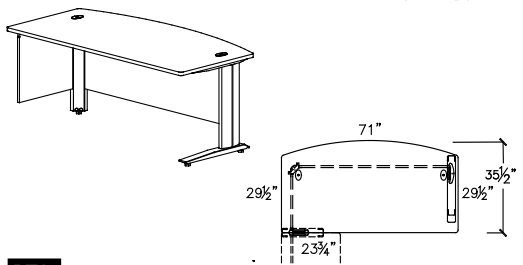

**RTA**

**BOWTOP 36" CORNER DESK RIGHT - CAN NOT STAND ALONE**

INCLUDES 30" END LEG & CORNER LEG - BACK & RIGHT SIDE MODESTY PANEL  
RETURN CONNECTS TO LEFT FRONT

|              |         |     |     |    |      |    |
|--------------|---------|-----|-----|----|------|----|
| 850-B3672CDR | \$1,221 | 117 | 4.6 | 71 | 35.5 | 29 |
|--------------|---------|-----|-----|----|------|----|

**850 DESKS**  
**STRAIGHT, BOWTOP & CORNER DESKS**

| MODEL | LIST | WEIGHT | CUBE            | W  | D  | H  |
|-------|------|--------|-----------------|----|----|----|
|       |      | LBS    | FT <sup>3</sup> | IN | IN | IN |

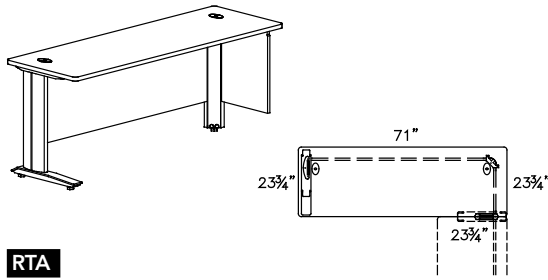

**RTA**

**24" CORNER DESK LEFT - CAN NOT STAND ALONE**

RETURN CONNECTS TO RIGHT FRONT. INCLUDES 24" END LEG & CORNER LEG - BACK & RIGHT SIDE MODESTY

|             |       |    |     |       |       |    |
|-------------|-------|----|-----|-------|-------|----|
| 850-2460CDL | \$796 | 85 | 3.1 | 59.25 | 23.75 | 29 |
| 850-2466CDL | \$835 | 92 | 3.3 | 65    | 23.75 | 29 |
| 850-2472CDL | \$880 | 98 | 3.4 | 71    | 23.75 | 29 |

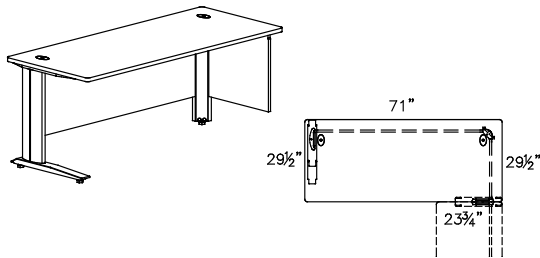

**RTA**

**30" CORNER DESK LEFT - CAN NOT STAND ALONE**

RETURN CONNECTS TO RIGHT FRONT. INCLUDES 30" END LEG & CORNER LEG - BACK & RIGHT SIDE MODESTY

|             |       |     |     |       |      |    |
|-------------|-------|-----|-----|-------|------|----|
| 850-3060CDL | \$882 | 95  | 3.6 | 59.25 | 29.5 | 29 |
| 850-3066CDL | \$915 | 102 | 3.8 | 65    | 29.5 | 29 |
| 850-3072CDL | \$953 | 109 | 4   | 71    | 29.5 | 29 |

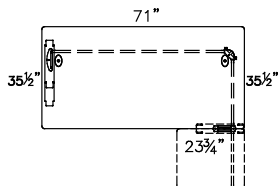

**RTA**

**36" CORNER DESK LEFT - CAN NOT STAND ALONE**

RETURN CONNECTS TO RIGHT FRONT. INCLUDES 30" END LEG & CORNER LEG - BACK & RIGHT SIDE MODESTY

|             |         |     |     |    |      |    |
|-------------|---------|-----|-----|----|------|----|
| 850-3672CDL | \$1,149 | 125 | 4.6 | 71 | 35.5 | 29 |
|-------------|---------|-----|-----|----|------|----|

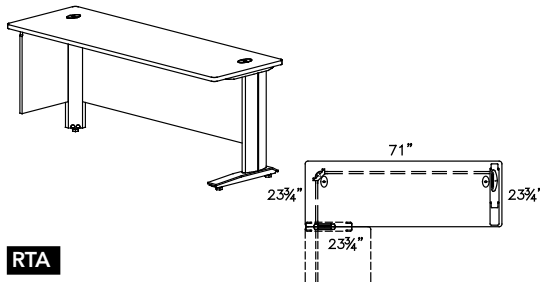

**RTA**

**24" CORNER DESK RIGHT - CAN NOT STAND ALONE**

RETURN CONNECTS TO LEFT FRONT. INCLUDES 24" END LEG & CORNER LEG - BACK & RIGHT SIDE MODESTY

|             |       |    |     |       |       |    |
|-------------|-------|----|-----|-------|-------|----|
| 850-2460CDR | \$796 | 85 | 3.1 | 59.25 | 23.75 | 29 |
| 850-2466CDR | \$835 | 92 | 3.3 | 65    | 23.75 | 29 |
| 850-2472CDR | \$880 | 98 | 3.4 | 71    | 23.75 | 29 |

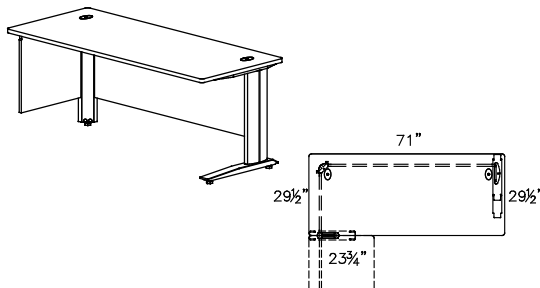

**RTA**

**30" CORNER DESK RIGHT - CAN NOT STAND ALONE**

RETURN CONNECTS TO LEFT FRONT. INCLUDES 30" END LEG & CORNER LEG - BACK & RIGHT SIDE MODESTY

|             |       |     |     |       |      |    |
|-------------|-------|-----|-----|-------|------|----|
| 850-3060CDR | \$882 | 95  | 3.6 | 59.25 | 29.5 | 29 |
| 850-3066CDR | \$915 | 102 | 3.8 | 65    | 29.5 | 29 |
| 850-3072CDR | \$953 | 109 | 4   | 71    | 29.5 | 29 |

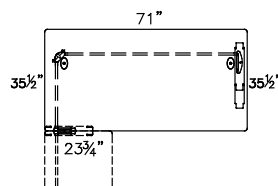



**RTA**

**36" CORNER DESK RIGHT - CAN NOT STAND ALONE**



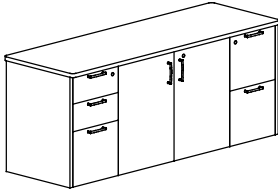
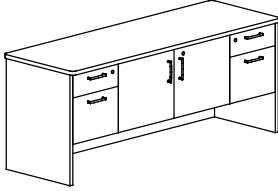
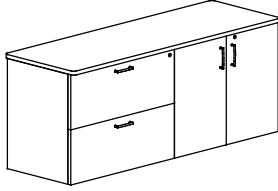
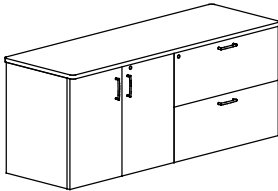

RETURN CONNECTS TO LEFT FRONT. INCLUDES 24" END LEG & CORNER LEG - BACK & RIGHT SIDE MODESTY

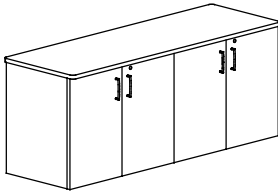
|             |         |     |     |    |      |    |
|-------------|---------|-----|-----|----|------|----|
| 850-3672CDR | \$1,149 | 125 | 4.6 | 71 | 35.5 | 29 |
|-------------|---------|-----|-----|----|------|----|

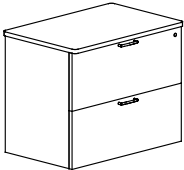
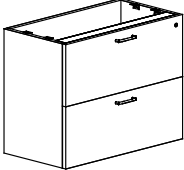
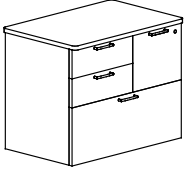

|   | MODEL  | LIST           | WEIGHT     | CUBE            | W            | D            | H         |
|---|--|----------------|------------|-----------------|--------------|--------------|-----------|
|   |  |                | LBS        | FT <sup>3</sup> | IN           | IN           | IN        |
|    | <b>CREDENZA</b>  |                |            |                 |              |              |           |
|   | BOX/BOX/FILE/CABINET/FILE/FILE. 24" DEEP W/ 1 ADJUSTABLE SHELF.  |                |            |                 |              |              |           |
|   | <b>850-UF2472CFF</b>   | <b>\$2,152</b> | <b>275</b> | <b>29</b>       | <b>71</b>    | <b>23.75</b> | <b>29</b> |
|   | <ul style="list-style-type: none"> <li>• 20" DEPTH AVAILABLE. ADD -20 WHEN ORDERING AND USE THE SAME PRICING.</li> </ul> <b>Ordering Example:</b> 850-UF2472CFF-20 |                |            |                 |              |              |           |
|    | <b>CREDENZA</b>  |                |            |                 |              |              |           |
|   | BOX/FILE/CABINET/BOX/FILE. 24" DEEP.   |                |            |                 |              |              |           |
|   | <b>850-F2472CF</b>   | <b>\$1,795</b> | <b>230</b> | <b>29</b>       | <b>71</b>    | <b>23.75</b> | <b>29</b> |
|   | <ul style="list-style-type: none"> <li>• 20" DEPTH AVAILABLE. ADD -20 WHEN ORDERING AND USE THE SAME PRICING.</li> </ul> <b>Ordering Example:</b> 850-F2472CF-20   |                |            |                 |              |              |           |
|    | <b>LATERAL FILE/CABINET CREDENZA</b>   |                |            |                 |              |              |           |
|   | 2 DRAWER LATERAL FILE/ 2 DOOR CABINET 24" DEEP W/ 1 ADJUSTABLE SHELF.  |                |            |                 |              |              |           |
|   | <b>850-LF2460C</b>   | <b>\$1,921</b> | <b>230</b> | <b>26</b>       | <b>59.25</b> | <b>23.75</b> | <b>29</b> |
|   | <b>850-LF2472C</b>   | <b>\$2,229</b> | <b>240</b> | <b>29</b>       | <b>71</b>    | <b>23.75</b> | <b>29</b> |
|   | <ul style="list-style-type: none"> <li>• 20" DEPTH AVAILABLE. ADD -20 WHEN ORDERING AND USE THE SAME PRICING.</li> </ul> <b>Ordering Example:</b> 850-LF2460C-20   |                |            |                 |              |              |           |
|  | <b>CABINET/LATERAL FILE CREDENZA</b>   |                |            |                 |              |              |           |
|   | 2 DOOR CABINET/ 2 DRAWER LATERAL FILE. 24" DEEP W/ 1 ADJUSTABLE SHELF.   |                |            |                 |              |              |           |
|   | <b>850-C2460LF</b>   | <b>\$1,921</b> | <b>230</b> | <b>26</b>       | <b>59.25</b> | <b>23.75</b> | <b>29</b> |
|   | <b>850-C2472LF</b>   | <b>\$2,229</b> | <b>240</b> | <b>29</b>       | <b>71</b>    | <b>23.75</b> | <b>29</b> |
|   | <ul style="list-style-type: none"> <li>• 20" DEPTH AVAILABLE. ADD -20 WHEN ORDERING AND USE THE SAME PRICING.</li> </ul> <b>Ordering Example:</b> 850-C2472LF-20   |                |            |                 |              |              |           |
|  | <b>CREDENZA</b>  |                |            |                 |              |              |           |
|   | 4 DRAWER LATERAL FILE 24" DEEP.  |                |            |                 |              |              |           |
|   | <b>850-LF2460LF</b>  | <b>\$2,050</b> | <b>240</b> | <b>26</b>       | <b>59.25</b> | <b>23.75</b> | <b>29</b> |
|   | <b>850-LF2472LF</b>  | <b>\$2,437</b> | <b>255</b> | <b>29</b>       | <b>71</b>    | <b>23.75</b> | <b>29</b> |
|   | <ul style="list-style-type: none"> <li>• 20" DEPTH AVAILABLE. ADD -20 WHEN ORDERING AND USE THE SAME PRICING.</li> </ul> <b>Ordering Example:</b> 850-LF2460LF-20  |                |            |                 |              |              |           |
|  | <b>CREDENZA</b>  |                |            |                 |              |              |           |
|   | 4 DOOR CABINET 24" DEEP W/ CENTER DIVIDER AND 1 ADJUSTABLE SHELF PER SIDE.   |                |            |                 |              |              |           |
|   | <b>850-C2460C</b>  | <b>\$1,748</b> | <b>240</b> | <b>26</b>       | <b>59.25</b> | <b>23.75</b> | <b>29</b> |
|   | <b>850-C2472C</b>  | <b>\$1,845</b> | <b>255</b> | <b>29</b>       | <b>71</b>    | <b>23.75</b> | <b>29</b> |
|   | <ul style="list-style-type: none"> <li>• 20" DEPTH AVAILABLE. ADD -20 WHEN ORDERING AND USE THE SAME PRICING.</li> </ul> <b>Ordering Example:</b> 850-C2472C-20    |                |            |                 |              |              |           |

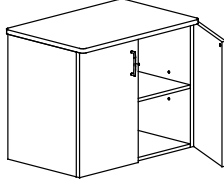
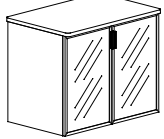
# 850 STORAGE CABINETS

|   | MODEL  | LIST    | AGD CHARGE | WEIGHT | CUBE            | W    | D     | H  |
|---|--|---------|------------|--------|-----------------|------|-------|----|
|   |  |         |            | LBS    | FT <sup>3</sup> | IN   | IN    | IN |
|    | <b>LATERAL FILE</b><br>2 DRAWER LATERAL FILE. ALL DRAWERS LOCK.  |         |            |        |                 |      |       |    |
|   | 850-2436LF   | \$1,167 |            | 145    | 18              | 35.5 | 23.75 | 29 |
|    | <b>LATERAL FILE - NO TOP</b><br>19" DEEP. FITS UNDER WORK SURFACE. LOCKING LATERAL FILE DRAWERS                              |         |            |        |                 |      |       |    |
|   | 850-1936LFX  | \$1,036 |            | 85     | 15              | 35.5 | 18.75 | 28 |
|    | <b>LATERAL FILE COMBO</b><br>BOX/BOX/FILE/LATERAL FILE. LATERAL FILE AND FILE DRAWER LOCK.                                   |         |            |        |                 |      |       |    |
|   | 850-2436UFL  | \$1,491 |            | 150    | 18              | 35.5 | 23.75 | 29 |
|    | <b>LATERAL FILE COMBO - NO TOP</b><br>BOX/BOX/FILE/LATERAL FILE. FITS UNDER WORK SURFACE. LATERAL FILE AND FILE DRAWER LOCK. |         |            |        |                 |      |       |    |
|   | 850-1936UFLX   | \$1,338 |            | 100    | 15              | 35.5 | 18.75 | 28 |
|  | <b>STORAGE CABINET</b><br>24" DEEP<br>1 ADJUSTABLE SHELF. 2 LOCKING HINGED DOORS.  |         |            |        |                 |      |       |    |
|   | 850-2436C  | \$1,008 | \$544      | 125    | 18              | 35.5 | 23.75 | 29 |
|  | <b>STORAGE CABINET - NO TOP</b><br>19" DEEP<br>1 ADJUSTABLE SHELF. 2 LOCKING HINGED DOORS. FITS UNDER WORK SURFACE.          |         |            |        |                 |      |       |    |
|   | 850-1936CX   | \$831   | \$544      | 75     | 15              | 35.5 | 18.75 | 28 |
|  | <b>TOP ONLY / TO GANG 2 NO TOP UNITS</b>   |         |            |        |                 |      |       |    |
|   | 850-2172TOP  | \$317   |            | 36     | 2               | 71   | 20.75 | 1  |

| MODEL | LIST | WEIGHT | CUBE            | W  | D  | H  |
|-------|------|--------|-----------------|----|----|----|
|       |      | LBS    | FT <sup>3</sup> | IN | IN | IN |

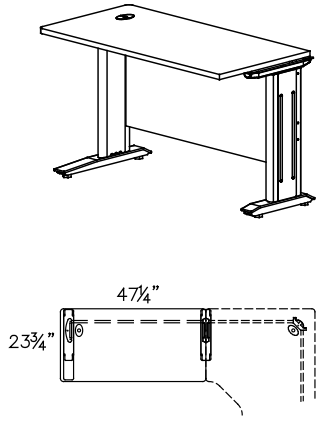

**24" LEFT CONNECTOR**

INCLUDES 1-24" END LEG & 1 SHARED LEG

|            |       |    |     |       |       |    |
|------------|-------|----|-----|-------|-------|----|
| 850-2424LC | \$465 | 44 | 2.1 | 23.75 | 23.75 | 29 |
| 850-2430LC | \$465 | 47 | 2.4 | 29.5  | 23.75 | 29 |
| 850-2436LC | \$497 | 51 | 2.5 | 35.5  | 23.75 | 29 |
| 850-2442LC | \$516 | 58 | 2.6 | 41.5  | 23.75 | 29 |
| 850-2448LC | \$541 | 64 | 2.8 | 47.25 | 23.75 | 29 |
| 850-2454LC | \$565 | 70 | 3   | 53.25 | 23.75 | 29 |
| 850-2460LC | \$578 | 76 | 3.1 | 59.25 | 23.75 | 29 |
| 850-2466LC | \$612 | 82 | 3.3 | 65    | 23.75 | 29 |
| 850-2472LC | \$647 | 88 | 3.5 | 71    | 23.75 | 29 |

**RTA**

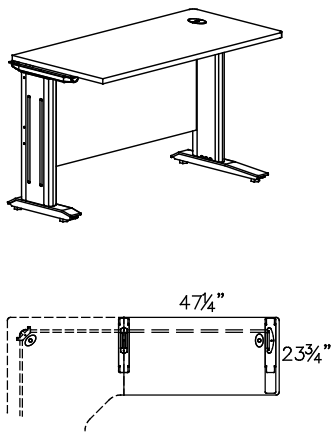

**24" RIGHT CONNECTOR**

INCLUDES 1-24" END LEG & 1 SHARED LEG

|            |       |    |     |       |       |    |
|------------|-------|----|-----|-------|-------|----|
| 850-2424RC | \$465 | 44 | 2.1 | 23.75 | 23.75 | 29 |
| 850-2430RC | \$465 | 47 | 2.4 | 29.5  | 23.75 | 29 |
| 850-2436RC | \$497 | 51 | 2.5 | 35.5  | 23.75 | 29 |
| 850-2442RC | \$516 | 58 | 2.6 | 41.5  | 23.75 | 29 |
| 850-2448RC | \$541 | 64 | 2.8 | 47.25 | 23.75 | 29 |
| 850-2454RC | \$565 | 70 | 3   | 53.25 | 23.75 | 29 |
| 850-2460RC | \$578 | 76 | 3.1 | 59.25 | 23.75 | 29 |
| 850-2466RC | \$612 | 82 | 3.3 | 65    | 23.75 | 29 |
| 850-2472RC | \$647 | 88 | 3.5 | 71    | 23.75 | 29 |

**RTA**

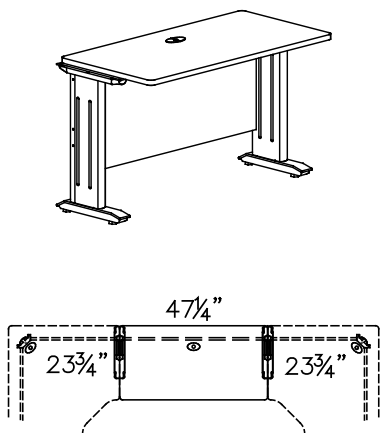

**24" CENTER CONNECTOR**

INCLUDES 2 SHARED LEGS

|            |       |    |     |       |       |    |
|------------|-------|----|-----|-------|-------|----|
| 850-2430CC | \$465 | 44 | 2.4 | 29.5  | 23.75 | 29 |
| 850-2436CC | \$497 | 47 | 2.5 | 35.5  | 23.75 | 29 |
| 850-2442CC | \$516 | 51 | 2.6 | 41.5  | 23.75 | 29 |
| 850-2448CC | \$541 | 58 | 2.8 | 47.25 | 23.75 | 29 |
| 850-2454CC | \$565 | 64 | 3   | 53.25 | 23.75 | 29 |
| 850-2460CC | \$578 | 70 | 3.1 | 59.25 | 23.75 | 29 |
| 850-2466CC | \$612 | 76 | 3.3 | 65    | 23.75 | 29 |
| 850-2472CC | \$647 | 82 | 3.5 | 71    | 23.75 | 29 |

**RTA**

# 850 CONNECTORS

## CONNECTORS - 30"

| MODEL | LIST | WEIGHT | CUBE            | W  | D  | H  |
|-------|------|--------|-----------------|----|----|----|
|       |      | LBS    | FT <sup>3</sup> | IN | IN | IN |

### 30" LEFT CONNECTOR, CUTBACK RIGHT

INCLUDES 1-30" END LEG & 1 SHARED LEG

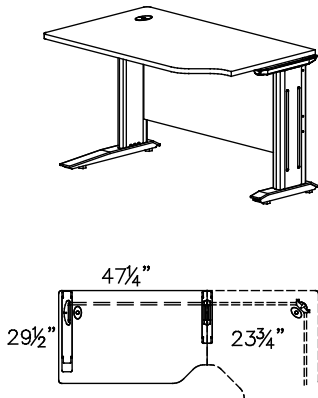

|               |       |     |     |       |      |    |
|---------------|-------|-----|-----|-------|------|----|
| 850-3030LC-CR | \$552 | 55  | 2.5 | 29.5  | 29.5 | 29 |
| 850-3036LC-CR | \$579 | 61  | 2.7 | 35.5  | 29.5 | 29 |
| 850-3042LC-CR | \$604 | 68  | 2.9 | 41.5  | 29.5 | 29 |
| 850-3048LC-CR | \$618 | 74  | 3.1 | 47.25 | 29.5 | 29 |
| 850-3054LC-CR | \$657 | 81  | 3.4 | 53.25 | 29.5 | 29 |
| 850-3060LC-CR | \$675 | 88  | 3.6 | 59.25 | 29.5 | 29 |
| 850-3066LC-CR | \$701 | 95  | 3.8 | 65    | 29.5 | 29 |
| 850-3072LC-CR | \$737 | 102 | 4   | 71    | 29.5 | 29 |

RTA

### 30" RIGHT CONNECTOR, CUTBACK LEFT

INCLUDES 1-30" END LEG & 1 SHARED LEG

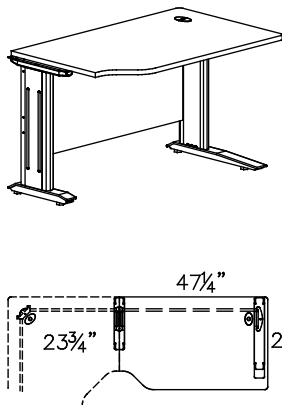

|               |       |     |     |       |      |    |
|---------------|-------|-----|-----|-------|------|----|
| 850-3030RC-CL | \$552 | 55  | 2.5 | 29.5  | 29.5 | 29 |
| 850-3036RC-CL | \$579 | 61  | 2.7 | 35.5  | 29.5 | 29 |
| 850-3042RC-CL | \$604 | 68  | 2.9 | 41.5  | 29.5 | 29 |
| 850-3048RC-CL | \$618 | 74  | 3.1 | 47.25 | 29.5 | 29 |
| 850-3054RC-CL | \$657 | 81  | 3.4 | 53.25 | 29.5 | 29 |
| 850-3060RC-CL | \$675 | 88  | 3.6 | 59.25 | 29.5 | 29 |
| 850-3066RC-CL | \$701 | 95  | 3.8 | 65    | 29.5 | 29 |
| 850-3072RC-CL | \$737 | 102 | 4   | 71    | 29.5 | 29 |

RTA

| MODEL | LIST | WEIGHT | CUBE            | W  | D  | H  |
|-------|------|--------|-----------------|----|----|----|
|       |      | LBS    | FT <sup>3</sup> | IN | IN | IN |

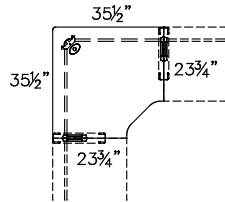
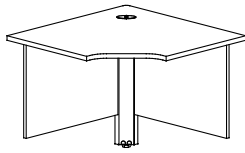

**CORNER MODULE**

INCLUDES 90° CORNER LEG. CAN NOT STAND ALONE.

|            |       |     |     |      |      |    |
|------------|-------|-----|-----|------|------|----|
| 850-2436CM | \$671 | 96  | 3.4 | 35.5 | 35.5 | 29 |
| 850-2442CM | \$784 | 102 | 4.5 | 41.5 | 41.5 | 29 |

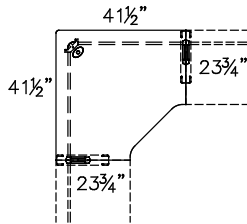
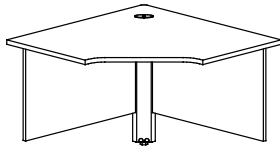

**RTA**

**EXTENDED CORNER MODULES**

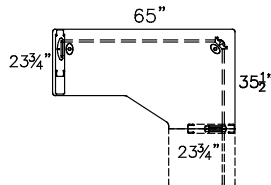
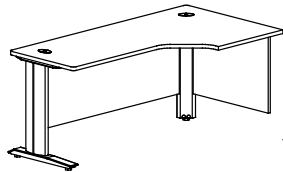

**LEFT EXTENDED CORNER MODULE**

INCLUDES 1-24" END LEG & 90° CORNER LEG. CAN NOT STAND ALONE.

|            |       |     |     |          |            |    |
|------------|-------|-----|-----|----------|------------|----|
| 850-6636CM | \$899 | 145 | 5.2 | 65/23.75 | 23.75/35.5 | 29 |
| 850-7236CM | \$943 | 155 | 5.8 | 71/23.75 | 23.75/35.5 | 29 |

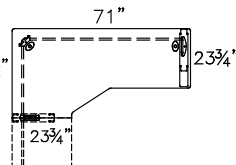
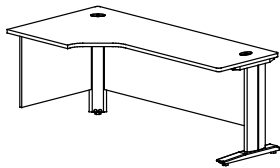

**RIGHT EXTENDED CORNER MODULE**

INCLUDES 1-24" END LEG & 90° CORNER LEG. CAN NOT STAND ALONE.

|            |       |     |     |          |            |    |
|------------|-------|-----|-----|----------|------------|----|
| 850-3666CM | \$899 | 145 | 5.2 | 23.75/65 | 35.5/23.75 | 29 |
| 850-3672CM | \$943 | 155 | 5.8 | 23.75/71 | 35.5/23.75 | 29 |

**RTA**

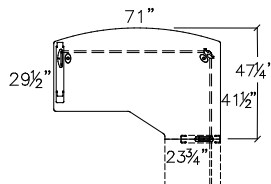
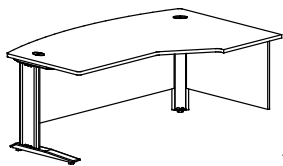

**LEFT EXTENDED BOWTOP CORNER MODULE**

INCLUDES 1-30" END LEG & 90° CORNER LEG. CAN NOT STAND ALONE.

|             |         |     |   |          |            |    |
|-------------|---------|-----|---|----------|------------|----|
| 850-B7248CM | \$1,340 | 180 | 7 | 71/23.75 | 29.5/47.25 | 29 |
|-------------|---------|-----|---|----------|------------|----|

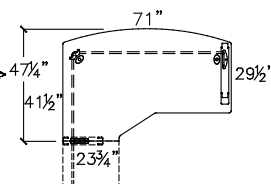
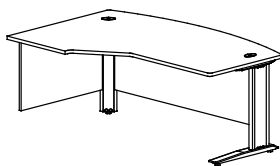

**RIGHT EXTENDED BOWTOP CORNER MODULE**

INCLUDES 1-30" END LEG & 90° CORNER LEG. CAN NOT STAND ALONE.

|             |         |     |   |          |            |    |
|-------------|---------|-----|---|----------|------------|----|
| 850-B4872CM | \$1,340 | 180 | 7 | 23.75/71 | 47.25/29.5 | 29 |
|-------------|---------|-----|---|----------|------------|----|

**RTA**

**850 TOPS**  
**ANGLED CORNERS**

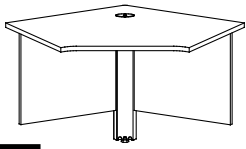
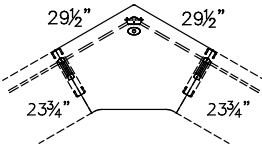
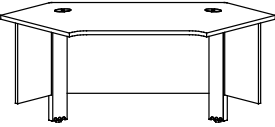
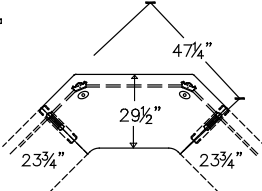
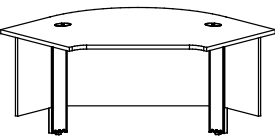
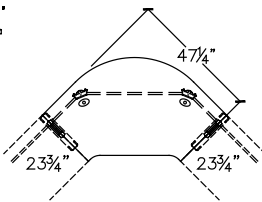
|  | MODEL   | LIST   | WEIGHT  | CUBE            | W   | D     | H         |
|--|---|--|---------|-----------------|-----|-------|-----------|
|  |   |  | LBS     | FT <sup>3</sup> | IN  | IN    | IN        |
|  <p><b>RTA</b></p> |  | <p><b>120° ANGLED CORNER MODULE</b><br/>INCLUDES 1-120° CORNER LEG. CAN NOT STAND ALONE.</p>       |         |                 |     |       |           |
|  |   | 850-2430AC120  | \$919   | 60              | 3.5 | 23.75 | 29.5/29.5 |
|  <p><b>RTA</b></p> |  | <p><b>NEO-ANGLED CORNER MODULE</b><br/>INCLUDES 2 - 135° CORNER LEGS. CAN NOT STAND ALONE.</p>     |         |                 |     |       |           |
|  |   | 850-2448NACM   | \$1,078 | 75              | 5.5 | 47.25 | 47.25     |
|  <p><b>RTA</b></p> |  | <p><b>BOW NEO-ANGLED CORNER MODULE</b><br/>INCLUDES 2 - 135° CORNER LEGS. CAN NOT STAND ALONE.</p> |         |                 |     |       |           |
|  |   | 850-2448BNACM  | \$1,213 | 90              | 6.5 | 47.25 | 47.25     |

**850 TOPS**  
**TRANSITION TOPS**

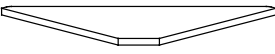
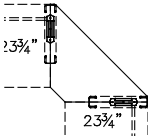
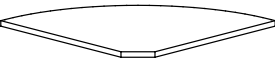
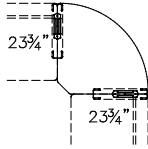
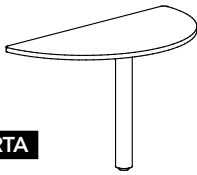
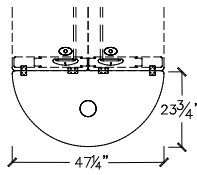
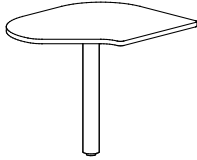
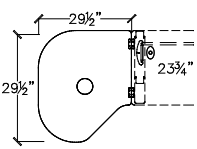
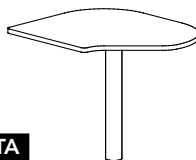
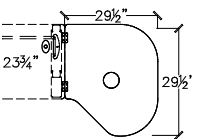
|  |   |   |       |    |     |            |       |
|--|---|---|-------|----|-----|------------|-------|
|  <p><b>RTA</b></p> |  | <p><b>ANGLED TRANSITION TOP</b></p>                           |       |    |     |            |       |
|  |   | 850-2424ATT   | \$239 | 12 | 0.5 | 23.75      | 23.75 |
|  <p><b>RTA</b></p> |  | <p><b>BOW TRANSITION TOP</b></p>                              |       |    |     |            |       |
|  |   | 850-2424BTT   | \$248 | 16 | 0.7 | 23.75      | 23.75 |
|  <p><b>RTA</b></p> |  | <p><b>HALF MOON TOP</b><br/>INCLUDES 1 POST LEG</p>           |       |    |     |            |       |
|  |   | 850-4824HM  | \$696 | 34 | 1.5 | 23.75      | 47.25 |
|                    |  | <p><b>END MEETING TABLE LEFT</b><br/>INCLUDES 1 POST LEG</p>  |       |    |     |            |       |
|  |   | 850-2430EMT-L   | \$474 | 28 | 1.2 | 23.75/29.5 | 23.75 |
|  <p><b>RTA</b></p> |  | <p><b>END MEETING TABLE RIGHT</b><br/>INCLUDES 1 POST LEG</p> |       |    |     |            |       |
|  |   | 850-2430EMT-R   | \$474 | 28 | 1.2 | 23.75/29.5 | 23.75 |

| MODEL | LIST | WEIGHT | CUBE            | W  | D  | H  |
|-------|------|--------|-----------------|----|----|----|
|       |      | LBS    | FT <sup>3</sup> | IN | IN | IN |

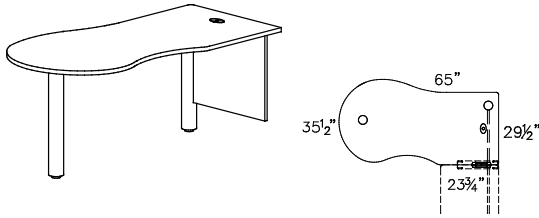

**SHAPED PENINSULA TOP LEFT**

INCLUDES 2 POST LEGS. CAN NOT STAND ALONE.

|               |                |     |     |          |           |    |
|---------------|----------------|-----|-----|----------|-----------|----|
| 850-3066SPT-L | <b>\$979</b>   | 110 | 6.5 | 65/23.75 | 35.5/29.5 | 29 |
| 850-3072SPT-L | <b>\$1,028</b> | 120 | 7   | 71/23.75 | 35.5/29.5 | 29 |

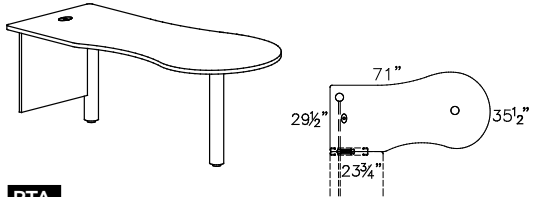

**SHAPED PENINSULA TOP RIGHT**

INCLUDES 2 POST LEGS. CAN NOT STAND ALONE.

|               |                |     |     |          |           |    |
|---------------|----------------|-----|-----|----------|-----------|----|
| 850-3066SPT-R | <b>\$979</b>   | 110 | 6.5 | 65/23.75 | 35.5/29.5 | 29 |
| 850-3072SPT-R | <b>\$1,028</b> | 120 | 7   | 71/23.75 | 35.5/29.5 | 29 |

**RTA**

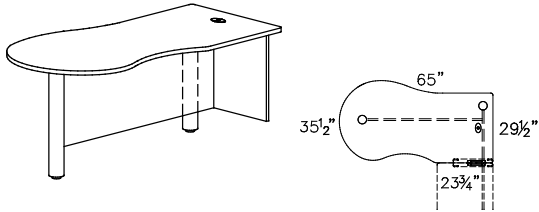

**SHAPED PENINSULA TOP LEFT W/ MODESTY PANEL**

INCLUDES 2 POST LEGS. CAN NOT STAND ALONE.

|                |                |     |     |          |           |    |
|----------------|----------------|-----|-----|----------|-----------|----|
| 850-3066SPTM-L | <b>\$1,114</b> | 120 | 7.5 | 65/23.75 | 35.5/29.5 | 29 |
| 850-3072SPTM-L | <b>\$1,162</b> | 130 | 8   | 71/23.75 | 35.5/29.5 | 29 |

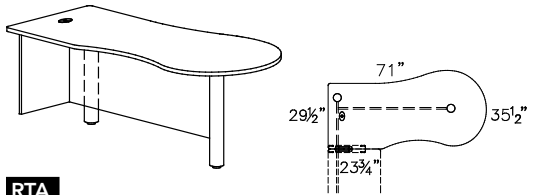

**SHAPED PENINSULA TOP RIGHT W/ MODESTY PANEL**

INCLUDES 2 POST LEGS. CAN NOT STAND ALONE.

|                |                |     |     |          |           |    |
|----------------|----------------|-----|-----|----------|-----------|----|
| 850-3066SPTM-R | <b>\$1,114</b> | 120 | 7.5 | 65/23.75 | 35.5/29.5 | 29 |
| 850-3072SPTM-R | <b>\$1,162</b> | 130 | 8   | 71/23.75 | 35.5/29.5 | 29 |

**RTA**

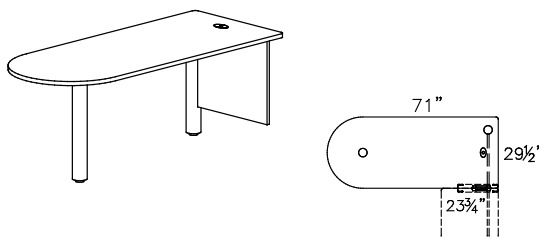

**BULLET TOP LEFT**

INCLUDES 2 POST LEGS. CAN NOT STAND ALONE.

|               |              |     |     |       |      |    |
|---------------|--------------|-----|-----|-------|------|----|
| 850-3060BTG-L | <b>\$800</b> | 95  | 4.2 | 59.25 | 29.5 | 29 |
| 850-3066BTG-L | <b>\$842</b> | 100 | 4.7 | 65    | 29.5 | 29 |
| 850-3072BTG-L | <b>\$896</b> | 105 | 6.2 | 71    | 29.5 | 29 |

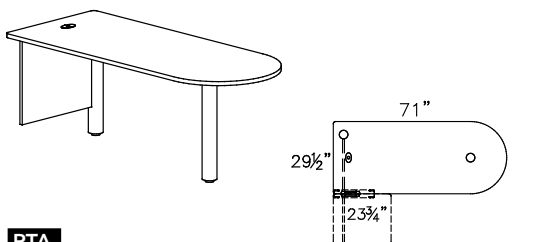

**BULLET TOP RIGHT**

INCLUDES 2 POST LEGS. CAN NOT STAND ALONE.

|               |              |     |     |       |      |    |
|---------------|--------------|-----|-----|-------|------|----|
| 850-3060BTG-R | <b>\$800</b> | 95  | 4.2 | 59.25 | 29.5 | 29 |
| 850-3066BTG-R | <b>\$842</b> | 100 | 4.7 | 65    | 29.5 | 29 |
| 850-3072BTG-R | <b>\$896</b> | 105 | 6.2 | 71    | 29.5 | 29 |

**RTA**

# 850 CORNER MODULES

## BULLET TOPS

| MODEL | LIST | WEIGHT | CUBE            | W  | D  | H  |
|-------|------|--------|-----------------|----|----|----|
|       |      | LBS    | FT <sup>3</sup> | IN | IN | IN |

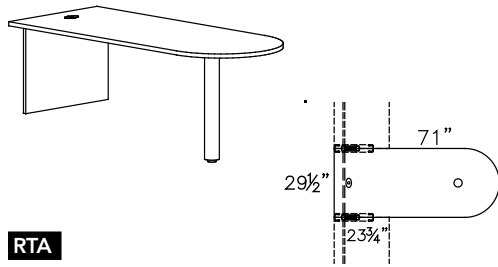

### BULLET TOP CENTER

INCLUDES 1 POST LEG. CAN NOT STAND ALONE.

|               |       |     |     |       |      |    |
|---------------|-------|-----|-----|-------|------|----|
| 850-3060BTG-C | \$732 | 95  | 4.2 | 59.25 | 29.5 | 29 |
| 850-3066BTG-C | \$777 | 100 | 4.7 | 65    | 29.5 | 29 |
| 850-3072BTG-C | \$829 | 105 | 6.2 | 71    | 29.5 | 29 |

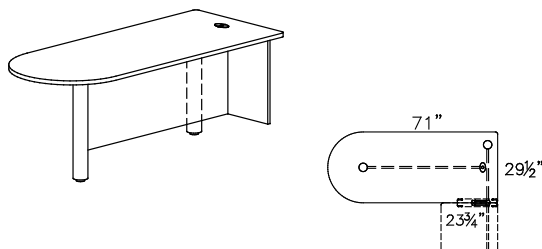

### BULLET TOP LEFT W/ MODESTY PANEL

INCLUDES 2 POST LEGS.

|                |         |     |     |       |      |    |
|----------------|---------|-----|-----|-------|------|----|
| 850-3060BTGM-L | \$935   | 105 | 4.7 | 59.25 | 29.5 | 29 |
| 850-3066BTGM-L | \$976   | 115 | 5.2 | 65    | 29.5 | 29 |
| 850-3072BTGM-L | \$1,029 | 120 | 6.7 | 71    | 29.5 | 29 |

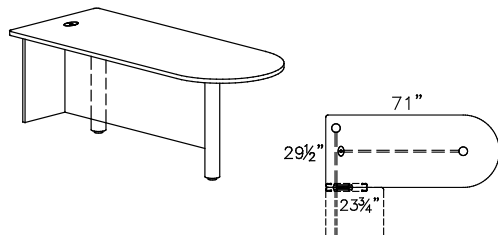

### BULLET TOP RIGHT W/ MODESTY PANEL

INCLUDES 2 POST LEGS.

|                |         |     |     |       |      |    |
|----------------|---------|-----|-----|-------|------|----|
| 850-3060BTGM-R | \$935   | 105 | 4.7 | 59.25 | 29.5 | 29 |
| 850-3066BTGM-R | \$976   | 115 | 5.2 | 65    | 29.5 | 29 |
| 850-3072BTGM-R | \$1,029 | 120 | 6.7 | 71    | 29.5 | 29 |

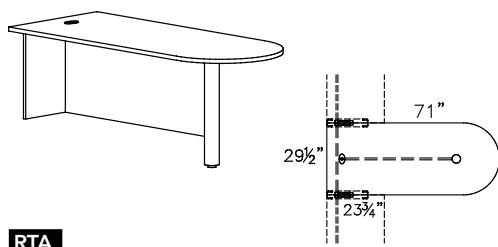

### BULLET TOP CENTER W/ MODESTY PANEL

INCLUDES 1 POST LEG.

|                |       |     |     |       |      |    |
|----------------|-------|-----|-----|-------|------|----|
| 850-3060BTGM-C | \$866 | 105 | 4.7 | 59.25 | 29.5 | 29 |
| 850-3066BTGM-C | \$911 | 115 | 5.2 | 65    | 29.5 | 29 |
| 850-3072BTGM-C | \$961 | 120 | 6.7 | 71    | 29.5 | 29 |

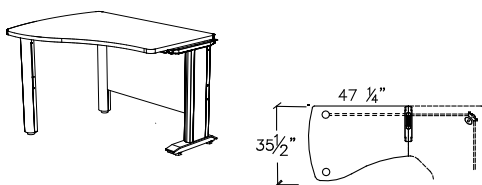

### WAVE TABLE LEFT

INCLUDES 2 POST LEGS & 1 SHARED LEG

|               |         |    |     |       |            |    |
|---------------|---------|----|-----|-------|------------|----|
| 850-3648WAV-L | \$1,112 | 49 | 3.5 | 47.25 | 35.5/23.75 | 29 |
|---------------|---------|----|-----|-------|------------|----|

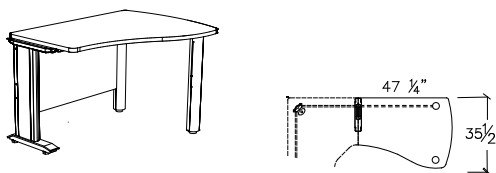

### WAVE TABLE RIGHT

INCLUDES 2 POST LEGS & 1 SHARED LEG

|               |         |    |     |       |            |    |
|---------------|---------|----|-----|-------|------------|----|
| 850-3648WAV-R | \$1,112 | 49 | 3.5 | 47.25 | 35.5/23.75 | 29 |
|---------------|---------|----|-----|-------|------------|----|

**RTA**



| MODEL | LIST | WEIGHT | CUBE            | W  | D  | H  |
|-------|------|--------|-----------------|----|----|----|
|       |      | LBS    | FT <sup>3</sup> | IN | IN | IN |

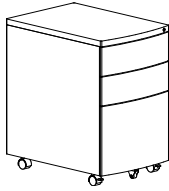

**METAL MOBILE PEDESTAL - FULL CARTON**

BOX / BOX / FILE PEDESTAL. ALL DRAWERS LOCK. LOCKING CASTERS.

|           |       |    |   |      |      |      |
|-----------|-------|----|---|------|------|------|
| 100-MMPUF | \$540 | 55 | 7 | 15.5 | 22.5 | 25.2 |
|-----------|-------|----|---|------|------|------|

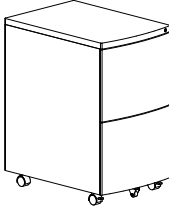

FILE / FILE PEDESTAL. ALL DRAWERS LOCK. LOCKING CASTERS.

|           |       |    |   |      |      |      |
|-----------|-------|----|---|------|------|------|
| 100-MMPFF | \$540 | 55 | 7 | 15.5 | 22.5 | 27.1 |
|-----------|-------|----|---|------|------|------|

- FOR KEYED ALIKE CORE PACKS ADD 100-COREPACK. INCLUDES 1 CORE, 1 CORE REMOVAL KEY AND TWO LOCK KEYS.

**Example:** IF YOU REQUIRE 3 UNITS TO BE KEYED-ALIKE,  
**ORDER 100-COREPACK-3 (\$11 X 3 = \$33).**

**AVAILABLE FINISHES:** BLACK (BL), TITANIUM (TT) & WHITE (WH)

**NOTE:** WE DO NOT RECOMMEND SITTING ON METAL MOBILE PEDESTALS.

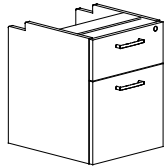

**HANGING BF PED**

BOX/FILE. ALL DRAWERS LOCK.

|         |       |    |   |       |       |      |
|---------|-------|----|---|-------|-------|------|
| 850-HPF | \$752 | 60 | 4 | 15.75 | 18.75 | 20.5 |
|---------|-------|----|---|-------|-------|------|

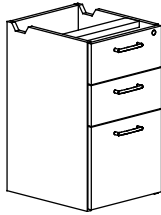

**FREESTANDING BBF PED - NO TOP**

BOX/BOX/FILE. ALL DRAWERS LOCK.

|           |       |    |   |       |       |    |
|-----------|-------|----|---|-------|-------|----|
| 850-FPUFX | \$916 | 75 | 5 | 15.75 | 18.75 | 28 |
|-----------|-------|----|---|-------|-------|----|

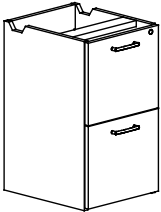

**FREESTANDING FF PED - NO TOP**

FILE/FILE. ALL DRAWERS LOCK.

|           |       |    |   |       |       |    |
|-----------|-------|----|---|-------|-------|----|
| 850-FPFFX | \$939 | 75 | 5 | 15.75 | 18.75 | 28 |
|-----------|-------|----|---|-------|-------|----|

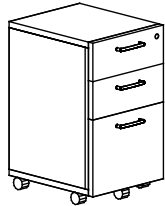

**MOBILE BBF PED**

BOX/BOX/FILE. FRONT CASTERS AND ALL DRAWERS LOCK.

|          |       |    |   |    |       |      |
|----------|-------|----|---|----|-------|------|
| 850-MPUF | \$965 | 75 | 5 | 16 | 18.75 | 27.5 |
|----------|-------|----|---|----|-------|------|

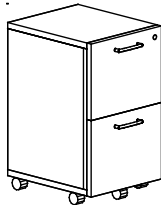

**MOBILE FF PED**

FILE/FILE. FRONT CASTERS AND ALL DRAWERS LOCK.

|          |       |    |   |    |       |      |
|----------|-------|----|---|----|-------|------|
| 850-MPFF | \$989 | 75 | 5 | 16 | 18.75 | 27.5 |
|----------|-------|----|---|----|-------|------|

# 850 HUTCHES & ACCESSORIES

## HUTCHES

| MODEL | LIST | AGD CHARGE | WEIGHT | CUBE            | W  | D  | H  |
|-------|------|------------|--------|-----------------|----|----|----|
|       |      |            | LBS    | FT <sup>3</sup> | IN | IN | IN |

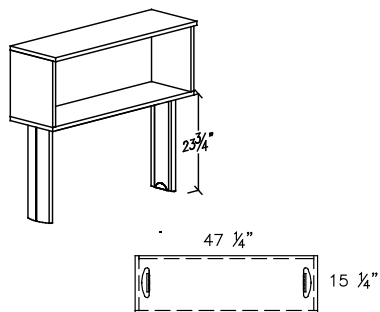

### OPEN HUTCHES / 41" HIGH

INCLUDES 2 HUTCH COLUMNS

|           |       |  |    |     |       |      |       |
|-----------|-------|--|----|-----|-------|------|-------|
| 850-4124H | \$525 |  | 54 | 2   | 23.75 | 15.5 | 40.75 |
| 850-4130H | \$525 |  | 58 | 2.2 | 29.5  | 15.5 | 40.75 |
| 850-4136H | \$540 |  | 60 | 2.4 | 35.5  | 15.5 | 40.75 |
| 850-4142H | \$579 |  | 68 | 2.6 | 41.5  | 15.5 | 40.75 |
| 850-4148H | \$583 |  | 72 | 2.8 | 47.25 | 15.5 | 40.75 |

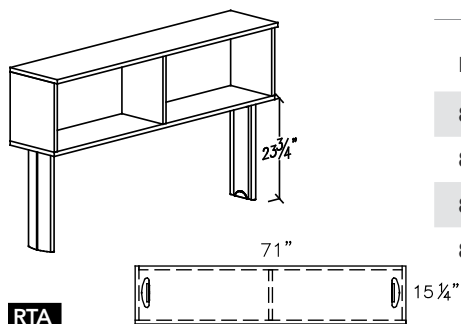

INCLUDES 2 HUTCH COLUMNS W/ DIVIDER

|           |       |  |    |     |       |      |       |
|-----------|-------|--|----|-----|-------|------|-------|
| 850-4154H | \$661 |  | 76 | 3   | 53.25 | 15.5 | 40.75 |
| 850-4160H | \$716 |  | 82 | 3.2 | 59.25 | 15.5 | 40.75 |
| 850-4166H | \$748 |  | 87 | 3.4 | 65    | 15.5 | 40.75 |
| 850-4172H | \$871 |  | 92 | 3.6 | 71    | 15.5 | 40.75 |

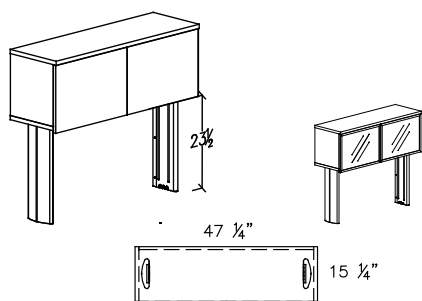

### HUTCH W/ HINGED DOORS / 41" HIGH

INCLUDES 2 HUTCH COLUMNS

|             |       |       |     |     |       |      |       |
|-------------|-------|-------|-----|-----|-------|------|-------|
| 850-4124HHD | \$682 | \$400 | 67  | 2.4 | 23.75 | 15.5 | 40.75 |
| 850-4130HHD | \$682 | \$400 | 75  | 2.7 | 29.5  | 15.5 | 40.75 |
| 850-4136HHD | \$714 | \$444 | 81  | 3   | 35.5  | 15.5 | 40.75 |
| 850-4142HHD | \$760 | \$488 | 93  | 3.3 | 41.5  | 15.5 | 40.75 |
| 850-4148HHD | \$813 | \$506 | 101 | 3.6 | 47.25 | 15.5 | 40.75 |

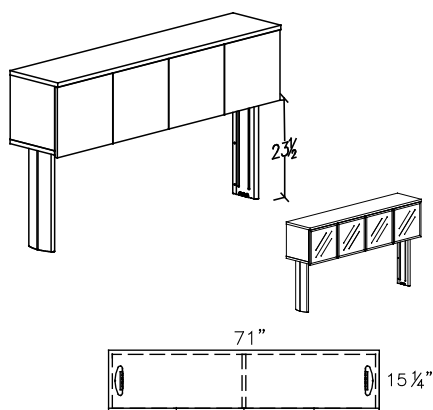

INCLUDES 2 HUTCH COLUMNS W/ DIVIDER

|             |         |       |     |     |       |      |       |
|-------------|---------|-------|-----|-----|-------|------|-------|
| 850-4154HHD | \$1,000 | \$776 | 110 | 3.9 | 53.25 | 15.5 | 40.75 |
| 850-4160HHD | \$1,032 | \$795 | 119 | 4.2 | 59.25 | 15.5 | 40.75 |
| 850-4166HHD | \$1,056 | \$844 | 128 | 4.5 | 65    | 15.5 | 40.75 |
| 850-4172HHD | \$1,183 | \$851 | 137 | 4.8 | 71    | 15.5 | 40.75 |

#### \*\* OPTIONAL ALUMINUM GLAZED DOORS \*\*

- SELECT CLEAR (CL), FROSTED (FR) OR BRONZE (BR) PLEXI GLASS  
- **Example:** 850-4148-AGD-FR
- TO LOCK HUTCH DOORS, ADD AN "L" TO ITEM # & ADD **\$76** TO RETAIL PRICE.  
- **Example:** 850-4148HHD-L
- HUTCH DOORS DO NOT REQUIRE HANDLES. TO ADD HANDLES PLEASE REFER TO PAGE 100-3
- THE PRICE SHOWN FOR AGD DOORS IS AN UP-CHARGE THAT MUST BE ADDED TO THE BASE PRICE OF THE UNIT IT GOES ON.

RTA

| MODEL | LIST | WEIGHT | CUBE            | W  | D  | H  |
|-------|------|--------|-----------------|----|----|----|
|       |      | LBS    | FT <sup>3</sup> | IN | IN | IN |

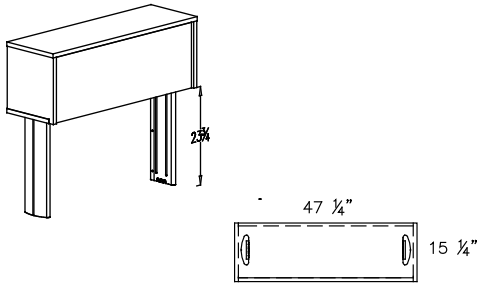

**HUTCH W/ FLIPPER DOORS / 41" HIGH**

INCLUDES 2 HUTCH COLUMNS

|             |       |     |     |       |      |       |
|-------------|-------|-----|-----|-------|------|-------|
| 850-4124HFD | \$682 | 67  | 2.4 | 23.75 | 15.5 | 40.75 |
| 850-4130HFD | \$682 | 75  | 2.7 | 29.5  | 15.5 | 40.75 |
| 850-4136HFD | \$714 | 81  | 3   | 35.5  | 15.5 | 40.75 |
| 850-4142HFD | \$760 | 93  | 3.3 | 41.5  | 15.5 | 40.75 |
| 850-4148HFD | \$813 | 101 | 3.6 | 47.25 | 15.5 | 40.75 |

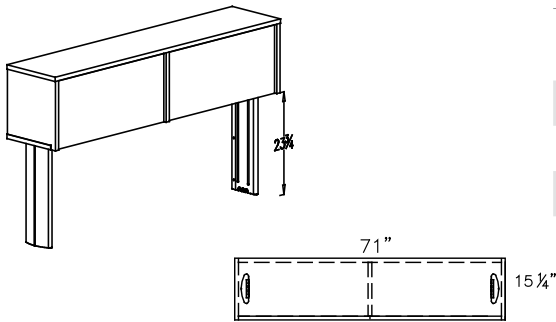

INCLUDES 2 HUTCH COLUMNS W/ DIVIDER

|             |         |     |     |       |      |       |
|-------------|---------|-----|-----|-------|------|-------|
| 850-4154HFD | \$1,000 | 110 | 3.9 | 53.25 | 15.5 | 40.75 |
| 850-4160HFD | \$1,032 | 119 | 4.2 | 59.25 | 15.5 | 40.75 |
| 850-4166HFD | \$1,056 | 128 | 4.5 | 65    | 15.5 | 40.75 |
| 850-4172HFD | \$1,183 | 137 | 4.8 | 71    | 15.5 | 40.75 |

- TO LOCK HUTCH DOORS, ADD AN "L" TO ITEM # & ADD **\$76** TO RETAIL PRICE  
- Example: 850-4148HFD-L

**RTA**

**HUTCH BACKS**

**HUTCH BACK**

INCLUDES MOUNTING HARDWARE

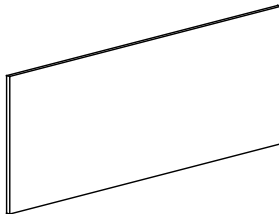

|          |       |    |     |       |      |       |
|----------|-------|----|-----|-------|------|-------|
| 850-24HB | \$163 | 10 | 0.2 | 16.5  | 0.75 | 23.75 |
| 850-30HB | \$163 | 13 | 0.3 | 22.25 | 0.75 | 23.75 |
| 850-36HB | \$179 | 16 | 0.4 | 28.25 | 0.75 | 23.75 |
| 850-42HB | \$188 | 19 | 0.5 | 34.25 | 0.75 | 23.75 |
| 850-48HB | \$198 | 23 | 0.6 | 4     | 0.75 | 23.75 |
| 850-54HB | \$211 | 28 | 0.7 | 46    | 0.75 | 23.75 |
| 850-60HB | \$246 | 32 | 0.8 | 52    | 0.75 | 23.75 |
| 850-66HB | \$294 | 35 | 0.9 | 57.75 | 0.75 | 23.75 |
| 850-72HB | \$323 | 39 | 1   | 63.75 | 0.75 | 23.75 |

**RTA**

**CORNER HUTCH BACK / ONE SIDE ONLY**

INCLUDES MOUNTING HARDWARE. ORDER 2 TO FILL RIGHT & LEFT SIDES.

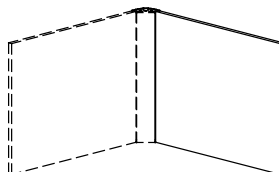

|           |       |    |     |      |      |       |
|-----------|-------|----|-----|------|------|-------|
| 850-36CHB | \$169 | 16 | 0.4 | 27.5 | 0.75 | 23.75 |
| 850-42CHB | \$175 | 19 | 0.5 | 33.5 | 0.75 | 23.75 |

**RTA**

# 850 HUTCHES & ACCESSORIES

## CORNER HUTCHES

| MODEL | LIST | WEIGHT | CUBE            | W  | D  | H  |
|-------|------|--------|-----------------|----|----|----|
|       |      | LBS    | FT <sup>3</sup> | IN | IN | IN |

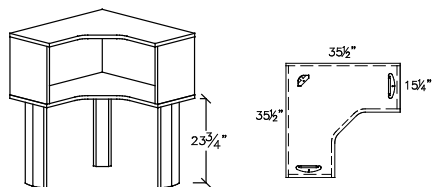

### CORNER HUTCH / 41" HIGH

INCLUDES 2 HUTCH COLUMNS AND 1 CORNER HUTCH POST.

|            |       |     |     |           |       |       |
|------------|-------|-----|-----|-----------|-------|-------|
| 850-4136CH | \$888 | 121 | 4.5 | 35.5/35.5 | 15.25 | 40.75 |
|------------|-------|-----|-----|-----------|-------|-------|

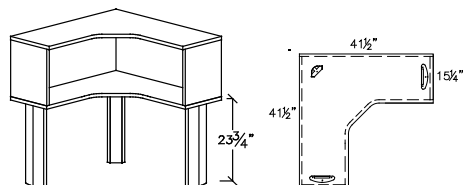

INCLUDES 2 HUTCH COLUMNS AND 1 CORNER HUTCH POST.

|            |       |     |     |           |       |       |
|------------|-------|-----|-----|-----------|-------|-------|
| 850-4142CH | \$993 | 148 | 5.5 | 41.5/41.5 | 15.25 | 40.75 |
|------------|-------|-----|-----|-----------|-------|-------|

RTA

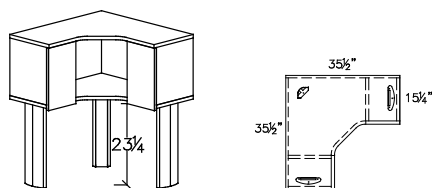

### CORNER HUTCH W/ HINGED DOORS / 41" HIGH

INCLUDES 2 HUTCH COLUMNS AND 1 CORNER HUTCH POST.

|              |         |     |   |           |       |       |
|--------------|---------|-----|---|-----------|-------|-------|
| 850-4136CHHD | \$1,118 | 138 | 5 | 35.5/35.5 | 15.25 | 40.75 |
|--------------|---------|-----|---|-----------|-------|-------|

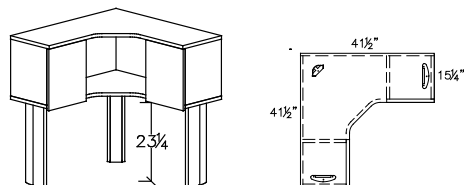

INCLUDES 2 HUTCH COLUMNS, 1 CORNER HUTCH POST, AND DIVIDERS.

|              |         |     |   |           |       |       |
|--------------|---------|-----|---|-----------|-------|-------|
| 850-4142CHHD | \$1,480 | 169 | 6 | 41.5/41.5 | 15.25 | 40.75 |
|--------------|---------|-----|---|-----------|-------|-------|

RTA

## TACKBOARDS

### TACK BOARDS

INCLUDES MOUNTING HARDWARE. HUTCH BACK REQUIRED.

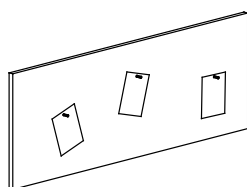

|          |       |    |     |       |     |       |
|----------|-------|----|-----|-------|-----|-------|
| 850-24TB | \$265 | 11 | 0.2 | 15    | 0.5 | 22.75 |
| 850-30TB | \$265 | 12 | 0.3 | 21    | 0.5 | 22.75 |
| 850-36TB | \$276 | 13 | 0.4 | 27    | 0.5 | 22.75 |
| 850-42TB | \$325 | 13 | 0.5 | 33    | 0.5 | 22.75 |
| 850-48TB | \$335 | 14 | 0.6 | 39    | 0.5 | 22.75 |
| 850-54TB | \$343 | 16 | 0.7 | 44.75 | 0.5 | 22.75 |
| 850-60TB | \$353 | 17 | 0.8 | 50.75 | 0.5 | 22.75 |
| 850-66TB | \$361 | 18 | 0.9 | 56.75 | 0.5 | 22.75 |
| 850-72TB | \$368 | 19 | 1   | 63.5  | 0.5 | 22.75 |

### CORNER TACK BOARD / ONE SIDE ONLY

INCLUDES MOUNTING HARDWARE. ORDER 2 TO FILL RIGHT & LEFT SIDES. HUTCH BACK IS REQUIRED

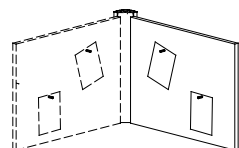

|           |       |    |     |       |     |       |
|-----------|-------|----|-----|-------|-----|-------|
| 850-36CTB | \$283 | 12 | 0.4 | 24    | 0.5 | 22.75 |
| 850-42CTB | \$325 | 13 | 0.5 | 29.75 | 0.5 | 22.75 |

| MODEL | LIST | AGD CHARGE | WEIGHT | CUBE            | W  | D  | H  |
|-------|------|------------|--------|-----------------|----|----|----|
|       |      |            | LBS    | FT <sup>3</sup> | IN | IN | IN |

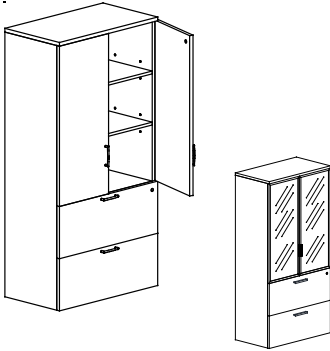

**TALL CABINET OVER LATERAL FILE**

20" DEEP W/ 1 FIXED, 2 ADJUSTABLE SHELVES, LOCKING CABINET & LATERAL FILE DRAWERS.

|                |         |       |     |    |      |       |       |
|----------------|---------|-------|-----|----|------|-------|-------|
| 850-7036CLF-20 | \$2,228 | \$813 | 302 | 36 | 35.5 | 19.75 | 69.75 |
|----------------|---------|-------|-----|----|------|-------|-------|

**\*\* OPTIONAL ALUMINUM GLAZED DOORS \*\***

- SELECT CLEAR (CL), FROSTED (FR) OR BRONZE (BR) PLEXI GLASS  
- **Example:** 850-7036CLF-AGD-FR
- AGD DOORS INCLUDE SILVER FINISH BAR HANDLES. PLEASE REFER TO PAGE 100-3. FOR OTHER HANDLE SELECTIONS.
- THE PRICE SHOWN FOR AGD DOORS IS AN UP-CHARGE THAT MUST BE ADDED TO THE BASE PRICE OF THE UNIT IT GOES ON.

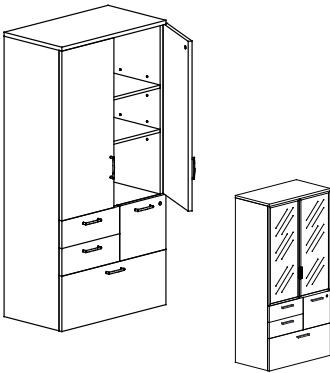

**TALL CABINET OVER COMBO LATERAL FILE**

20" DEEP W/ 1 FIXED, 2 ADJUSTABLE SHELVES, LOCKING CABINET, LOCKING FILE & LATERAL FILE DRAWERS.

|                |         |       |     |    |      |       |       |
|----------------|---------|-------|-----|----|------|-------|-------|
| 850-7036UFL-20 | \$2,337 | \$813 | 302 | 36 | 35.5 | 19.75 | 69.75 |
|----------------|---------|-------|-----|----|------|-------|-------|

**\*\* OPTIONAL ALUMINUM GLAZED DOORS \*\***

- SELECT CLEAR (CL), FROSTED (FR) OR BRONZE (BR) PLEXI GLASS  
- **Example:** 850-7036UFL-AGD-FR
- AGD DOORS INCLUDE SILVER FINISH BAR HANDLES. PLEASE REFER TO PAGE 100-3. FOR OTHER HANDLE SELECTIONS.
- THE PRICE SHOWN FOR AGD DOORS IS AN UP-CHARGE THAT MUST BE ADDED TO THE BASE PRICE OF THE UNIT IT GOES ON.

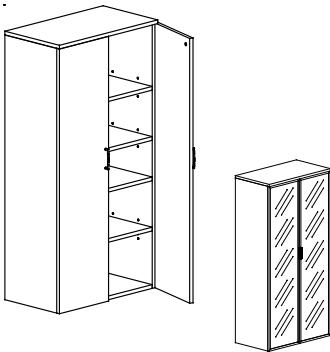

**TALL CABINET**

20" DEEP W/ 2 FIXED, 3 ADJUSTABLE SHELVES, & LOCKING CABINET.

|              |         |         |     |    |      |       |       |
|--------------|---------|---------|-----|----|------|-------|-------|
| 850-7036C-20 | \$1,994 | \$1,158 | 330 | 36 | 35.5 | 19.75 | 69.75 |
|--------------|---------|---------|-----|----|------|-------|-------|

**\*\* OPTIONAL ALUMINUM GLAZED DOORS \*\***

- SELECT CLEAR (CL), FROSTED (FR) OR BRONZE (BR) PLEXI GLASS  
- **Example:** 850-7036C-AGD-FR
- AGD DOORS INCLUDE SILVER FINISH BAR HANDLES. PLEASE REFER TO PAGE 100-3. FOR OTHER HANDLE SELECTIONS.
- THE PRICE SHOWN FOR AGD DOORS IS AN UP-CHARGE THAT MUST BE ADDED TO THE BASE PRICE OF THE UNIT IT GOES ON.

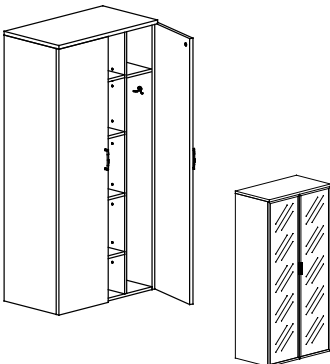

**TALL WARDROBE CABINET**

20" DEEP W/ 2 FIXED, 3 ADJUSTABLE SHELVES. FULL HEIGHT WARDROBE W/ COAT HOOKS. LOCKING CABINET.

|               |         |         |     |    |      |       |       |
|---------------|---------|---------|-----|----|------|-------|-------|
| 850-7036WC-20 | \$2,185 | \$1,158 | 320 | 36 | 35.5 | 19.75 | 69.75 |
|---------------|---------|---------|-----|----|------|-------|-------|

**\*\* OPTIONAL ALUMINUM GLAZED DOORS \*\***

- SELECT CLEAR (CL), FROSTED (FR) OR BRONZE (BR) PLEXI GLASS  
- **Example:** 850-7036WC-AGD-FR
- AGD DOORS INCLUDE SILVER FINISH BAR HANDLES. PLEASE REFER TO PAGE 100-3. FOR OTHER HANDLE SELECTIONS.
- THE PRICE SHOWN FOR AGD DOORS IS AN UP-CHARGE THAT MUST BE ADDED TO THE BASE PRICE OF THE UNIT IT GOES ON.

| MODEL | LIST | AGD CHARGE | WEIGHT | CUBE            | W  | D  | H  |
|-------|------|------------|--------|-----------------|----|----|----|
|       |      |            | LBS    | FT <sup>3</sup> | IN | IN | IN |

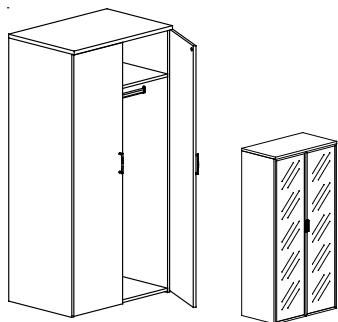

### DOUBLE DOOR CLOSET CABINET

24" DEEP. INCLUDES HAT SHELF & COAT ROD. OPTIONAL BOOT SHELF AVAILABLE. LOCKING CABINET.

|                |         |         |     |    |      |       |       |
|----------------|---------|---------|-----|----|------|-------|-------|
| 850-7036CLC-24 | \$2,007 | \$1,158 | 325 | 36 | 35.5 | 23.75 | 69.75 |
|----------------|---------|---------|-----|----|------|-------|-------|

#### \*\* OPTIONAL ALUMINUM GLAZED DOORS \*\*

- SELECT CLEAR (CL), FROSTED (FR) OR BRONZE (BR) PLEXI GLASS  
- **Example:** 850-7036CLC-AGD-FR
- AGD DOORS INCLUDE SILVER FINISH BAR HANDLES. PLEASE REFER TO PAGE [100-3](#). FOR OTHER HANDLE SELECTIONS.
- THE PRICE SHOWN FOR AGD DOORS IS AN UP-CHARGE THAT MUST BE ADDED TO THE BASE PRICE OF THE UNIT IT GOES ON.

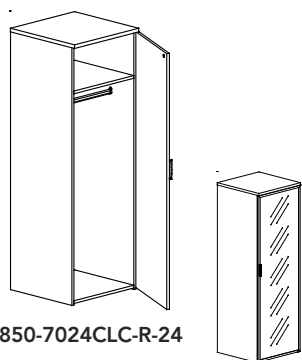

850-7024CLC-R-24

### SINGLE DOOR CLOSET CABINET

24" DEEP. INCLUDES HAT SHELF & COAT ROD. OPTIONAL BOOT SHELF AVAILABLE. LOCKING CABINET.

|                  |         |       |     |    |       |       |       |
|------------------|---------|-------|-----|----|-------|-------|-------|
| 850-7024CLC-L-24 | \$1,894 | \$689 | 215 | 27 | 23.75 | 23.75 | 69.75 |
| 850-7024CLC-R-24 | \$1,894 | \$689 | 215 | 27 | 23.75 | 23.75 | 69.75 |

#### \*\* OPTIONAL ALUMINUM GLAZED DOORS \*\*

- SELECT CLEAR (CL), FROSTED (FR) OR BRONZE (BR) PLEXI GLASS  
- **Example:** 850-7024CLC-R-AGD-FR
- AGD DOORS INCLUDE SILVER FINISH BAR HANDLES. PLEASE REFER TO PAGE [100-3](#). FOR OTHER HANDLE SELECTIONS.
- THE PRICE SHOWN FOR AGD DOORS IS AN UP-CHARGE THAT MUST BE ADDED TO THE BASE PRICE OF THE UNIT IT GOES ON.

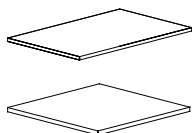

### OPTIONAL BOOT SHELF

All tall wardrobe storage & storage cabinets can have an optional boot shelf. Upcharges apply when ordering See [850-4](#)

bootshelf: add **-BS** to product SKU.

> **Ordering Example:** 850-7024CLC-L-24-BS

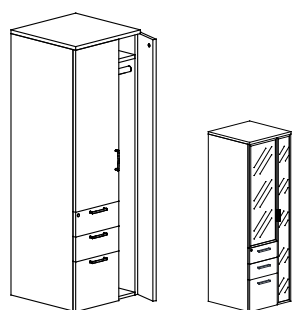

850-7024CUFWR-24

### PERSONAL WARDROBE STORAGE / LEFT

WARDROBE STORAGE 1 FIXED & 1 ADJUSTABLE SHELF. LOCKING.

|                  |         |         |     |    |       |       |       |
|------------------|---------|---------|-----|----|-------|-------|-------|
| 850-7024CUFWL-24 | \$2,250 | \$1,132 | 260 | 27 | 23.75 | 23.75 | 69.75 |
| 850-7024CUFWR-24 | \$2,250 | \$1,132 | 260 | 27 | 23.75 | 23.75 | 69.75 |

#### \*\* OPTIONAL ALUMINUM GLAZED DOORS \*\*

- SELECT CLEAR (CL), FROSTED (FR) OR BRONZE (BR) PLEXI GLASS  
- **Example:** 850-7024CLC-R-AGD-FR
- AGD DOORS INCLUDE SILVER FINISH BAR HANDLES. PLEASE REFER TO PAGE [100-3](#). FOR OTHER HANDLE SELECTIONS.
- THE PRICE SHOWN FOR AGD DOORS IS AN UP-CHARGE THAT MUST BE ADDED TO THE BASE PRICE OF THE UNIT IT GOES ON.

| ITEMS | ITEM DESCRIPTION | LIST |
|-------|------------------|------|
|-------|------------------|------|

**LAYOUT #1**

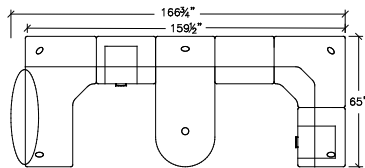
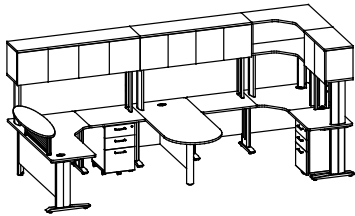

|                |                                       |                  |
|----------------|---------------------------------------|------------------|
| 850-6636CM     | LEFT EXTENDED CORNER MODULE           | <b>\$899</b>     |
| 850-2430CC     | 24" CENTER CONNECTOR                  | 2 X <b>\$465</b> |
| 850-3066BTGM-C | CENTRE BULLET TOP W/ MODESTY          | <b>\$911</b>     |
| 850-2436CM     | CORNER MODULE                         | <b>\$671</b>     |
| 850-2430RC     | RIGHT CONNECTOR                       | <b>\$465</b>     |
| 850-4166HHD    | HUTCH W/ HINGED DOORS                 | <b>\$1,056</b>   |
| 850-4160HHD    | HUTCH W/ HINGED DOORS                 | <b>\$1,032</b>   |
| 850-4136CH     | CORNER HUTCH / 41" HIGH               | <b>\$888</b>     |
| 850-4130HHD    | HUTCH W/ HINGED DOORS                 | <b>\$682</b>     |
| 850-MPUF       | MOBILE BBF PED                        | 2 X <b>\$965</b> |
| OUT-12POST     | OUTLINES POST PACKAGE                 | 2 X <b>\$94</b>  |
| OUT-1236PYP    | 12" X 36" POLYCARBONATE PANEL W/RAILS | <b>\$289</b>     |
| OUT1-1248ETA   | ELLIPTICAL TRANSACTION TOP            | <b>\$453</b>     |
| <b>TOTAL</b>   |                                       | <b>\$10,394</b>  |

**LAYOUT #2**

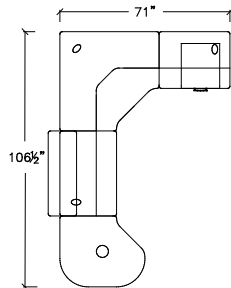
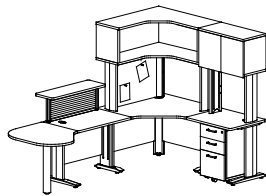

|               |                                       |                 |
|---------------|---------------------------------------|-----------------|
| 850-2430EMT-L | END MEETING TABLE LEFT                | <b>\$474</b>    |
| 850-2436LC    | LEFT CONNECTOR                        | <b>\$497</b>    |
| 850-2442CM    | CORNER MODULE                         | <b>\$784</b>    |
| 850-2430RC    | RIGHT CONNECTOR                       | <b>\$465</b>    |
| 850-4142CH    | CORNER HUTCH / 41" HIGH               | <b>\$993</b>    |
| 850-4130HHD   | HUTCH W/ HINGED DOORS                 | <b>\$682</b>    |
| 850-42CHB     | 42" CORNER HUTCH BACK - ONE SIDE ONLY | <b>\$175</b>    |
| 850-42CTB     | CORNER TACKBOARD - ONE SIDE ONLY      | <b>\$325</b>    |
| 850-MPUF      | MOBILE BBF PED                        | <b>\$965</b>    |
| OUT1-1236TA   | TRANSACTION TOP                       | <b>\$179</b>    |
| OUT-12POST    | OUTLINES POST PACKAGE                 | 2 X <b>\$94</b> |
| OUT-1236PYP   | 12" X 36" POLYCARBONATE PANEL W/RAILS | <b>\$289</b>    |
| <b>TOTAL</b>  |                                       | <b>\$6,016</b>  |

**LAYOUT #3**

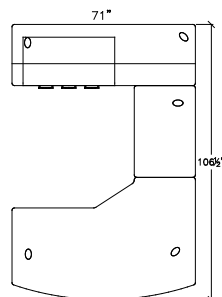
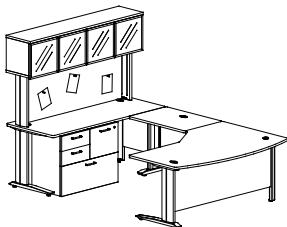

|                 |                                     |                |
|-----------------|-------------------------------------|----------------|
| 850-2472CDL     | CORNER DESK - LEFT                  | <b>\$880</b>   |
| 850-2436CC      | CENTRE CONNECTOR                    | <b>\$497</b>   |
| 850-B4872CM     | RIGHT EXTENDED BOWTOP CM            | <b>\$1,340</b> |
| 850-4172HHD-AGD | HUTCH W/ ALUMINUM FRAME GLASS DOORS | <b>\$1,183</b> |
|                 | <i>AGD UPCHARGE</i>                 | <b>\$851</b>   |
| 850-72HB        | HUTCH BACK                          | <b>\$323</b>   |
| 850-72TB        | TACK BOARD                          | <b>\$368</b>   |
| 850-1936UFLX    | LATERAL FILE COMBO - NO TOP         | <b>\$1,338</b> |
| <b>TOTAL</b>    |                                     | <b>\$6,780</b> |

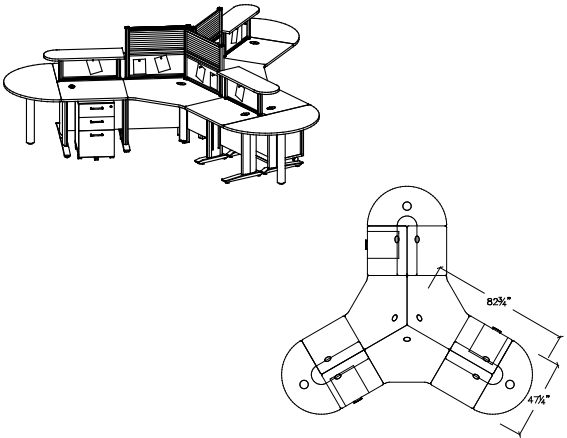
|  | ITEMS            | ITEM DESCRIPTION          | LIST |                 |
|--|------------------|---------------------------|------|-----------------|
|  | <b>LAYOUT #4</b> |                           |      |                 |
|  | 850-2430AC120    | 120° ANGLED CORNER MODULE | 3 X  | <b>\$919</b>    |
|  | 850-2430LC       | LEFT CONNECTOR            | 3 X  | <b>\$465</b>    |
|  | 850-2430RC       | RIGHT CONNECTOR           | 3 X  | <b>\$465</b>    |
|  | 850-4824HM       | HALF MOON TOP             | 3 X  | <b>\$696</b>    |
|  | OUT-12POST       | OUTLINES POST PACKAGE     | 6 X  | <b>\$94</b>     |
|  | OUT-24POST       | POST PACKAGES             | 6 X  | <b>\$158</b>    |
|  | OUT-1230TBP      | TACKBOARD PANEL           | 6 X  | <b>\$289</b>    |
|  | OUT-1230PYP      | POLYCARBONATE PANEL       | 3 X  | <b>\$240</b>    |
|  | OUT1-1236BTA     | BULLET TRANSACTION TOP    | 3 X  | <b>\$276</b>    |
|  | 850-MPUF         | MOBILE BBF PED            | 3 X  | <b>\$965</b>    |
|  |                  | <b>TOTAL</b>              |      | <b>\$15,324</b> |

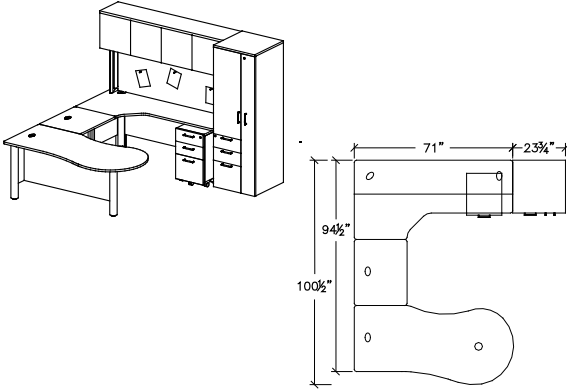
|   |                  |                                   |                |                |
|---|------------------|-----------------------------------|----------------|----------------|
|  | <b>LAYOUT #5</b> |                                   |                |                |
|   | 850-3072SPTM-L   | SHAPED PENINSULA TOP - LEFT       |                | <b>\$1,162</b> |
|   | 850-2430CC       | 24" CENTER CONNECTOR              |                | <b>\$465</b>   |
|   | 850-3672CM       | RIGHT EXTENDED CORNER MODULE      |                | <b>\$943</b>   |
|   | 850-4172HHD      | HUTCH W/ HINGED DOORS             |                | <b>\$1,183</b> |
|   | 850-72HB         | HUTCH BACK                        |                | <b>\$323</b>   |
|   | 850-72TB         | TACKBOARD                         |                | <b>\$368</b>   |
|   | 850-MPUF         | MOBILE BBF PED                    |                | <b>\$965</b>   |
|   | 850-7024CUFWR-24 | PERSONAL WARDROBE STORAGE / RIGHT |                | <b>\$2,250</b> |
|   | <b>TOTAL</b>     |                                   | <b>\$7,659</b> |                |

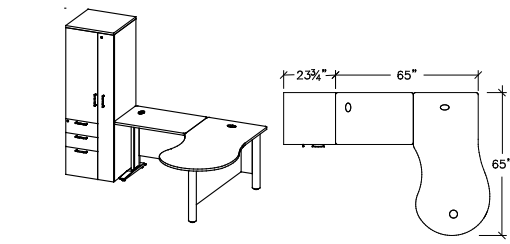
|  |                  |   |                |                |
|--|------------------|---|----------------|----------------|
|  | <b>LAYOUT #6</b> |   |                |                |
|  | 850-3066SPTM-R   | SHAPED PENINSULA TOP RIGHT W/ MODESTY PANEL |                | <b>\$1,114</b> |
|  | 850-2436LC       | LEFT CONNECTOR                              |                | <b>\$497</b>   |
|  | 850-7024CUFWR-24 | PERSONAL WARDROBE STORAGE / RIGHT           |                | <b>\$2,250</b> |
|  | <b>TOTAL</b>     |   | <b>\$3,861</b> |                |

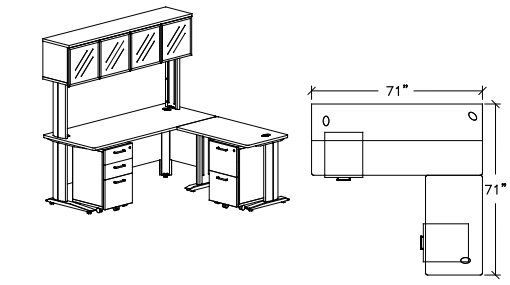
|  |                  |                                     |                |                |
|--|------------------|-------------------------------------|----------------|----------------|
|  | <b>LAYOUT #7</b> |                                     |                |                |
|  | 850-3072CDL      | CORNER DESK - LEFT                  |                | <b>\$953</b>   |
|  | 850-2442RC       | RIGHT CONNECTOR                     |                | <b>\$516</b>   |
|  | 850-4172HHD-AGD  | HUTCH W/ ALUMINUM FRAME GLASS DOORS |                | <b>\$1,183</b> |
|  |                  | <i>AGD UPCHARGE</i>                 |                | <b>\$851</b>   |
|  | 850-MPUF         | MOBILE BBF PED                      |                | <b>\$965</b>   |
| 850-MPFF   | MOBILE FF PED    |                                     | <b>\$989</b>   |                |
|  | <b>TOTAL</b>     |                                     | <b>\$5,457</b> |                |



| ITEMS            | ITEM DESCRIPTION             | LIST           |
|------------------|------------------------------|----------------|
| <b>LAYOUT #8</b> |                              |                |
| 850-3648WAV-L    | WAVE MEETING TABLE - LEFT    | \$1,112        |
| 850-3672CM       | RIGHT EXTENDED CORNER MODULE | \$943          |
| 850-7024CLC-R-24 | SINGLE DOOR CLOSET CABINET   | \$1,894        |
| 850-4172HHD      | HUTCH W/ HINGED DOORS        | \$1,183        |
| 850-72HB         | HUTCH BACK                   | \$323          |
| 850-72TB         | TACK BOARD                   | \$368          |
| 850-MPUF         | MOBILE BBF PED               | \$965          |
| <b>TOTAL</b>     |                              | <b>\$6,788</b> |

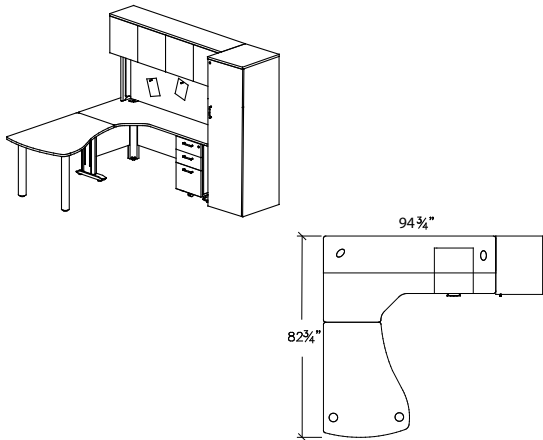

|                  |                                       |                |
|------------------|---------------------------------------|----------------|
| <b>LAYOUT #9</b> |                                       |                |
| 850-2436LC       | LEFT CONNECTOR                        | \$497          |
| 850-2436CM       | CORNER MODULE                         | \$671          |
| 850-2436RC       | RIGHT CONNECTOR                       | \$497          |
| 850-MPUF         | MOBILE BBF PED                        | \$965          |
| OUT-12POST       | OUTLINES POST PACKAGE                 | 3 X \$94       |
| OUT-1272PYP      | POLYCARBONATE PANEL                   | 2 X \$545      |
| OUT1-1272SCTA-L  | SHAPED CORNER TRANSACTION TOP - LEFT  | \$469          |
| OUT1-1272SCTA-R  | SHAPED CORNER TRANSACTION TOP - RIGHT | \$469          |
| <b>TOTAL</b>     |                                       | <b>\$4,940</b> |

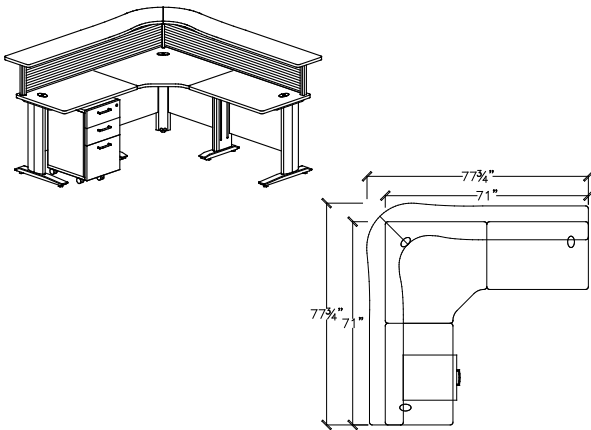

|                   |                                   |                |
|-------------------|-----------------------------------|----------------|
| <b>LAYOUT #10</b> |                                   |                |
| 850-3030LC-CR     | 30" LEFT CONNECTOR, CUTBACK RIGHT | \$552          |
| 850-2448BNACM     | BOW NEO-ANGLED CORNER MODULE      | \$1,213        |
| 850-3030RC-CL     | 30" RIGHT CONNECTOR, CUTBACK LEFT | \$552          |
| 850-MPUF          | MOBILE BBF PED                    | \$965          |
| <b>TOTAL</b>      |                                   | <b>\$3,282</b> |

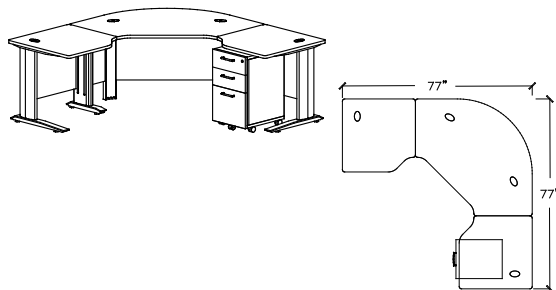

|                   |                                     |                |
|-------------------|-------------------------------------|----------------|
| <b>LAYOUT #11</b> |                                     |                |
| 850-2436LC        | LEFT CONNECTOR                      | \$497          |
| 850-2424BTT       | BOW TRANSITION TOP                  | \$248          |
| 850-2436RC        | RIGHT CONNECTOR                     | \$497          |
| 850-2430EMT-R     | END MEETING TABLE RIGHT             | \$474          |
| 100-MMPFF         | METAL MOBILE PEDESTAL - FULL CARTON | \$540          |
| <b>TOTAL</b>      |                                     | <b>\$2,256</b> |

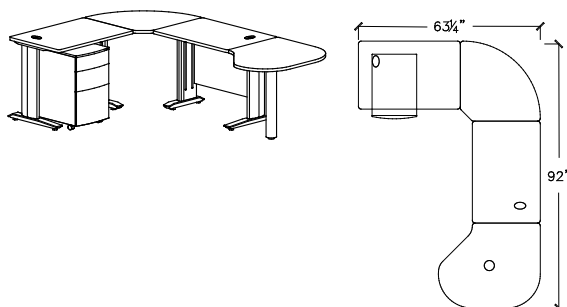

# 850 SERIES LAYOUTS

|  | ITEMS             | ITEM DESCRIPTION      | LIST           |
|--|-------------------|-----------------------|----------------|
|  | <b>LAYOUT #12</b> |                       |                |
|  | 850-2460LC        | LEFT CONNECTOR        | \$578          |
|  | 850-2424ATT       | ANGLED TRANSITION TOP | \$239          |
|  | 850-2436RC        | RIGHT CONNECTOR       | \$497          |
|  | 850-MPUF          | MOBILE BBF PED        | \$965          |
|  |                   | <b>TOTAL</b>          | <b>\$2,279</b> |

|             |                          |                          |                |
|-------------|--------------------------|--------------------------|----------------|
|             | <b>LAYOUT #13</b>        |                          |                |
|             | 850-2430EMT-L            | END MEETING TABLE LEFT   | \$474          |
|             | 850-2430LC               | LEFT CONNECTOR           | \$465          |
|             | 850-2448NACM             | NEO-ANGLED CORNER MODULE | \$1,078        |
|             | 850-2454RC               | RIGHT CONNECTOR          | \$565          |
|             | 850-MPUF                 | MOBILE BBF PED.          | \$965          |
|             | 850-2172TOP              | TOP ONLY                 | \$317          |
|             | 850-1936CX               | STORAGE CABINET - NO TOP | \$831          |
|             | 850-1936LFX              | NO TOP LATERAL FILE      | \$1,036        |
|             | OUT-12POST               | OUTLINES POST PACKAGE    | 2 X \$94       |
|             | OUT-1272PYP              | POLYCARBONATE PANEL      | \$545          |
| OUT1-1272TA | STRAIGHT TRANSACTION TOP | \$345                    |                |
|             |                          | <b>TOTAL</b>             | <b>\$6,809</b> |

|  |                   |                           |                |
|--|-------------------|---------------------------|----------------|
|  | <b>LAYOUT #14</b> |                           |                |
|  | 850-2436LC        | LEFT CONNECTOR            | \$497          |
|  | 850-2430AC120     | 120° ANGLED CORNER MODULE | \$919          |
|  | 850-2436RC        | RIGHT CONNECTOR           | \$497          |
|  | 850-MPUF          | MOBILE BBF PED            | \$965          |
|  |                   | <b>TOTAL</b>              | <b>\$2,878</b> |

|            |                    |                                    |                |
|------------|--------------------|------------------------------------|----------------|
|            | <b>LAYOUT #15</b>  |                                    |                |
|            | 850-2436CC         | 24" CENTER CONNECTOR               | \$497          |
|            | 850-2472DS         | 24" DESK SHELL                     | \$647          |
|            | 850-B7248CM        | LEFT EXTENDED BOWTOP CORNER MODULE | \$1,340        |
|            | 850-MPUF           | MOBILE BBF PED                     | \$965          |
|            | 388-1872OS         | OVERHEAD STORAGE - OPEN            | \$888          |
|            | 388-4724OUFWL-24   | MID-HEIGHT OPEN WARDROBE STORAGE   | \$1,562        |
|            | 100-MA1            | PNEUMATIC LCD SINGLE MONITOR ARM   | \$306          |
|            | 100-MA2            | PNEUMATIC LCD DUAL MONITOR ARM     | \$436          |
|            | 100-KD28           | KEYBOARD DRAWER                    | 2 X \$202      |
| 100-2-HCPU | HANGING CPU HOLDER | \$188                              |                |
|            |                    | <b>TOTAL</b>                       | <b>\$7,233</b> |

# WORKSCAPE SERIES

This is a metric series (imperial sizing available). Please refer to page [INDEX-1](#) for details

|  |                        |
|--|------------------------|
| <b>Series Specifications &amp; Description</b> .....   | <a href="#">WRK-3</a>  |
| <b>Work Surface Stiffener Bars - Usage Chart</b> ..... | <a href="#">WRK-6</a>  |
| <b>Product by Category</b> .....                       |                        |
| <b>Stiffener Bars</b> .....                            | <a href="#">WRK-6</a>  |
| <b>Designating Grommet Location Chart</b> .....        | <a href="#">WRK-7</a>  |
| <b>Work Surface Tops</b> .....                         | <a href="#">WRK-7</a>  |
| <b>Work Surface Supports</b> .....                     |                        |
| Bracket Kits .....                                     | <a href="#">WRK-8</a>  |
| Risers .....   | <a href="#">WRK-9</a>  |
| Spacers .....  | <a href="#">WRK-9</a>  |
| Metal Legs .....                                       | <a href="#">WRK-10</a> |
| Support & Storage Gables .....                         | <a href="#">WRK-11</a> |
| Open Bookcases- no Top .....                           | <a href="#">WRK-11</a> |
| <b>Pedestals</b> .....                                 |                        |
| Freestanding Pedestals .....                           | <a href="#">WRK-12</a> |
| Mobile Pedestals .....                                 | <a href="#">WRK-12</a> |
| <b>Seat Cushions</b> .....                             | <a href="#">WRK-13</a> |
| <b>Modesty &amp; Divider Panels</b> .....              |                        |
| Laminate Modesty Panels .....                          | <a href="#">WRK-14</a> |
| Aluminium Glazed Modesty Panels .....                  | <a href="#">WRK-14</a> |
| Plexi Modesty/Divider Panels .....                     | <a href="#">WRK-14</a> |
| <b>Storage Cabinets</b> .....                          |                        |
| No-Top Cabinets .....                                  | <a href="#">WRK-15</a> |
| <b>Credenzas</b> .....                                 |                        |
| Credenzas- 29" High .....                              | <a href="#">WRK-17</a> |
| Credenzas- 27" High .....                              | <a href="#">WRK-18</a> |
| Credenzas- 21" High .....                              | <a href="#">WRK-21</a> |

**continued...**

|   |                        |
|---|------------------------|
| <b>Hutches</b> .....                              |                        |
| Work Surface End Hutches w/ Metal Supports .....  | <a href="#">WRK-24</a> |
| Work Surface End Hutches w/ Laminate Gables ..... | <a href="#">WRK-24</a> |
| Hutches w/ Metal Supports .....                   | <a href="#">WRK-25</a> |
| Hutches w/ Laminate Gables .....                  | <a href="#">WRK-28</a> |
| Tackboards for Hutches .....                      | <a href="#">WRK-29</a> |
| Desktop Cubbies .....                             | <a href="#">WRK-29</a> |
| <b>Storage</b> .....                              |                        |
| Overhead Storage .....                            | <a href="#">WRK-30</a> |
| Tall Combo Storage .....                          | <a href="#">WRK-31</a> |
| Bookcases .....                                   | <a href="#">WRK-35</a> |
| <b>WorkSpace Series Layouts</b> .....             | <a href="#">WRK-36</a> |

## WorkScope

**Made-to-FIT** modular, modern, sleek design, with flexibility, style, function, and durability. WorkScope can be as simple or as comprehensive as your design imagination allows.

## Features

- ♥ Multiple storage options, including low credenzas that fit under work surfaces, and benches that double as storage.
- ♥ Solid colour, wood grain or two tone combinations available.
- ♥ Metal hutch supports, risers, and v-legs are available in silver (SL) & white (WH).
- ♥ Over 340 components.

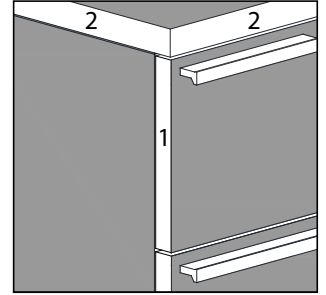

Matching 2mm edge band on 29" high tops & 1mm on all other edges

## Finishes

| LAMINATES |                    | SUITABLE FOR |        |               | DEFAULT FINISHES    |              |                 |
|-----------|--------------------|--------------|--------|---------------|---------------------|--------------|-----------------|
| ABBR      | LAMINATE COLOUR    | TOPS         | BASE   | MATCHING EDGE | HANDLES-(BLACK BAR) | LOCK (BLACK) | GROMMET (BLACK) |
| AM        | Autumn Maple       | ✓            | ✓      | ✓             | ✓                   | ✓            | ✓               |
| BL        | Black              | ✗            | ✓      | ✓             | ✓                   | ✓            | ✓               |
| BW        | Black Walnut       | ✓            | ✓      | ✓             | ✓                   | ✓            | ✓               |
| CD        | Cappuccino Dream** | ✓            | ✓      | ✓             | ✓                   | ✓            | ✓               |
| CM        | Charcoal Matrix    | ✓            | ✓      | Black         | ✓                   | ✓            | ✓               |
| DE        | Desert Sand        | ✓            | ✓      | ✓             | ✓                   | ✓            | ✓               |
| DD        | Driftwood***       | ✓            | ✓ (1") | ✓             | ✓                   | ✓            | ✓               |
| DW        | Driftwood Grey**   | ✗            | ✓ (¾") | ✓             | ✓                   | ✓            | ✓               |
| EZ        | Evening Zen        | ✓            | ✓      | ✓             | Aluminium           | ✓            | ✓               |
| GA        | Golden Ash         | ✓            | ✓      | ✓             | ✓                   | ✓            | ✓               |
| GD        | Grey Dusk          | ✓            | ✓      | ✓             | Aluminium           | ✓            | ✓               |
| GM        | Grey Matrix        | ✓            | ✓      | Grey          | ✓                   | ✓            | ✓               |
| GR        | Grey               | ✓            | ✓      | ✓             | ✓                   | ✓            | ✓               |
| GT        | Graphite           | ✗            | ✓      | ✓             | ✓                   | ✓            | ✓               |
| HM        | Hardrock Maple     | ✓            | ✓      | ✓             | ✓                   | ✓            | ✓               |
| NC        | Noce Coca          | ✓            | ✓      | ✓             | Aluminium           | Silver       | Grey            |
| PW        | Pure White         | ✓            | ✓      | ✓             | Aluminium           | Silver       | Grey            |
| RM        | Royal Mahogany     | ✓            | ✓      | ✓             | ✓                   | ✓            | ✓               |
| SM        | Sugar Maple        | ✓            | ✓      | ✓             | ✓                   | ✓            | ✓               |
| SW        | Seaside White      | ✓            | ✓      | ✓             | Aluminium           | Silver       | Grey            |
| VA        | Volcanic Ash       | ✓            | ✓      | ✓             | ✓                   | ✓            | ✓               |
| WW        | Winter Wood        | ✓            | ✓      | ✓             | Aluminium           | Silver       | Grey            |

\*\*Textured Finish

\*\*\*Non-textured 1" & 1½" material only

**High Pressure (HP) laminate available** Contact Customer Service.

## Construction

- ♥ 29" high Work Surfaces are 1" thick.
- ♥ Laminate Modesty Panels, Door and Drawer Fronts are ¾" thick.
- ♥ All wood product parts have thermally fused laminate on a 45 lb. industrial particle board core.
- ♥ Leveling glides are standard on all floor units.
- ♥ Plexi Modesty Panels are ¼" thick.

**continued...**

## Edge Detail

- ♥ Banding changes to an alternate Heartwood standard colour are available at no extra charge.
- ♥ All edges have durable matching 2mm edge band on 29" high tops and 1mm on all other edges.

## Drawers

- ♥ All drawers are 5 pieces - 4 x 1/2" black sides & 1 x 1/8" black bottom.
- ♥ All drawers and doors have handles except Hutch hinged doors. Bi-pass Hutch doors and Hutch Sliding doors come with handles but all other models do not.
- ♥ All box and file drawers mounted on FULL extension ball bearing slides, 100 lb. load rating.
- ♥ Lateral file drawers mounted on FULL extension ball bearing slides, 150 lb. load rating.
- ♥ Each file drawer features side rails and adjustable file bars that accommodate front-to-back letter or side to side legal sized hanging folders.
- ♥ One Pencil Tray included with every box drawer unit.

### NOTE:

- ♥ All File and Lateral Files drawers are constructed to support hanging file folders. Broken drawer bottoms are not covered by warranty. If you expect to store heavy items, ie phone books, paper etc. on the drawer bottom, we offer an optional 1/2" bottom for these drawers. Please contact Customer Service for pricing.

## Handles

- ♥ Handle changes can be made at no extra charge on units that come standard with handles- refer to **100 Series Accessories (ACC)** page **100-3** for selection details
- ♥ All drawers and doors have handles except for hutch doors. Hutch door handles may be added for an up-charge of **\$38** per handle

## Glazed Doors & Panels

- ♥ All glazed doors and panels consist of an aluminum frame with a 5mm plexiglass panel.
- ♥ The prices shown for aluminum frame glazed doors is an upcharge and must be added to the base price of the unit it goes on.
- ♥ AGD doors are not locking by default, add **-L** to the SKU and upcharge of **\$76**
- ♥ Doors include silver finish, bar handles (except on hutches & overheads with hinged doors which do not need handles).
- ♥ Frames have a natural, brushed aluminum finish.
- ♥ HML AGD doors differ from HDL and will not match if paired together.
- ♥ Plexiglass panels are available in 3 styles:
  - > Clear (CL)
  - > Frosted (FR)
  - > Bronze (BR)

Please indicate on your PO which plexiglass style you would like.

## Locks

- ♥ All tall cabinet and storage cabinet laminate doors and drawers lock, except where noted in price book.
- ♥ To add an optional lock to a component or Aluminum Glazed Doors (AGD), add **-L** to the SKU and upcharge of **\$76**
- ♥ Hutch & overhead storage doors do not lock, unless requested. There is a **\$76** upcharge.

When ordering, add an **'L'** to item **Example: WRK-2824WEMHHD-L**

Core Removable Locks are standard on all drawer pedestals, lateral files and storage cabinets.

For Keyed-a-like locks, indicate on your order, which standard units you would like keyed-a-like.

Order the appropriate quantity of like numbered cores required at **\$11** each.

< **Ordering Example:** If you require 3 units to be keyed alike, **order 100-COREPACK-3 (\$11 X 3 = \$33).**

## Accessories

- ♥ Refer to 100 Series **ACC** page **100-1** for a complete list of keyboard trays, pencil drawers, grommets, task lighting, CPU holders, etc.

## Custom Sizes

- ♥ Custom Widths available
    - For simple width changes, use the price of the next model size up.
- Ordering Example:** For the price of a **WRK-2468WS:**  
Take the price of **the next larger size- WRK-2472WS= \$392**

**NOTE:**

- ♥ If doors, drawers, height and depth changes are involved, please contact Customer Service for a quote.
- ♥ Please specify Quote Number when ordering.

## Shipping

- ♥ Some items are shipped fully assembled, some are shipped in RTA cartoning.
- ♥ Look for RTA symbol **RTA** at each model number.

**NOTE:** Information is current at time of print. For up to date information check online at [www.heartwood.ca](http://www.heartwood.ca).

# WORK SURFACE STIFFENER BARS - USAGE CHART

**WORK SURFACE WITH A  
FREESTANDING PEDESTAL  
& A METAL V-LEG**  
WRK-2478WS  
WRK-1624FPUFX-L  
WRK-24MVLEG

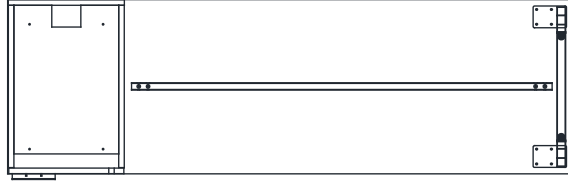

| WORK SURFACE WIDTH | STIFFENER  |
|--------------------|------------|
| 60                 | 100-WSB-40 |
| 66                 | 100-WSB-46 |
| 72                 | 100-WSB-52 |
| 78                 | 100-WSB-58 |
| 84                 | 100-WSB-64 |

**WORK SURFACE WITH  
TWO (2) FREESTANDING  
PEDESTALS**  
WRK-2478WS  
2 x WRK-1624FPUFX-L

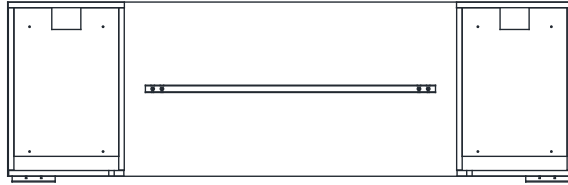

| WORK SURFACE WIDTH | STIFFENER  |
|--------------------|------------|
| 78                 | 100-WSB-40 |
| 84                 | 100-WSB-46 |

**WORK SURFACE WITH  
A SUPPORT GABLE & A  
FREESTANDING PEDESTAL**  
WRK-2478WS  
WRK-1624SG-L  
WRK-1624FPUFX-L

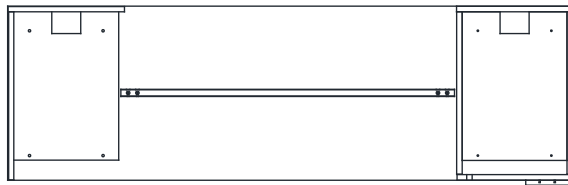

| WORK SURFACE WIDTH | STIFFENER  |
|--------------------|------------|
| 72                 | 100-WSB-40 |
| 78                 | 100-WSB-46 |
| 84                 | 100-WSB-52 |

**WORK SURFACE WITH  
A SUPPORT GABLE & A  
METAL V-LEG**  
WRK-2478WS  
WRK-1624SG-L  
WRK-24MVLEG



| WORK SURFACE WIDTH | STIFFENER  |
|--------------------|------------|
| 60                 | 100-WSB-40 |
| 66                 | 100-WSB-46 |
| 72                 | 100-WSB-52 |
| 78                 | 100-WSB-58 |
| 84                 | 100-WSB-64 |

**WORK SURFACE WITH TWO  
(2) SUPPORT GABLES**  
WRK-2478WS  
2 x WRK-1624SG-L



| WORK SURFACE WIDTH | STIFFENER  |
|--------------------|------------|
| 72                 | 100-WSB-40 |
| 78                 | 100-WSB-46 |
| 84                 | 100-WSB-52 |

**WORK SURFACE WITH  
METAL V-LEG & WORK  
SURFACE RISER OR SPACER**  
WRK-2478WS  
WRK-24MVLEG  
WRK-24MVR



| WORK SURFACE WIDTH | STIFFENER                     |
|--------------------|-------------------------------|
| 48                 | 100-WSB-40                    |
| 54                 | 100-WSB-46                    |
| 60                 | 100-WSB-52                    |
| 66                 | 100-WSB-58                    |
| 72                 | 100-WSB-64                    |
| 78                 | 100-WSB-70                    |
| 84                 | REQUIRES<br>CENTER<br>SUPPORT |

**METAL V-LEGS CAN NOT STAND ALONE**

**FOR STAND ALONE APPLICATIONS USE 900  
SERIES LOOP LEGS**

WRK-3072WS  
WRK-LOOP30 x 2

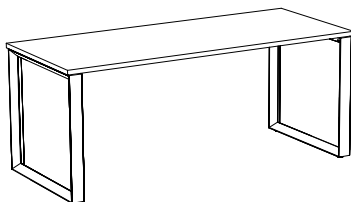



| MODEL                 | LIST | DESCRIPTION       | WEIGHT<br>LBS | CUBE<br>FT <sup>3</sup> |
|-----------------------|------|-------------------|---------------|-------------------------|
| <b>STIFFENER BARS</b> |      |                   |               |                         |
| 100-WSB-40            | \$82 | 40" STIFFENER BAR | 5.5           | 0.2                     |
| 100-WSB-46            | \$82 | 46" STIFFENER BAR | 6.4           | 0.2                     |
| 100-WSB-52            | \$82 | 52" STIFFENER BAR | 7.1           | 0.2                     |
| 100-WSB-58            | \$82 | 58" STIFFENER BAR | 8.2           | 0.2                     |
| 100-WSB-64            | \$82 | 64" STIFFENER BAR | 9             | 0.2                     |
| 100-WSB-70            | \$82 | 70" STIFFENER BAR | 9.9           | 0.3                     |



- UNSUPPORTED WORKSURFACE WIDTHS 84" OR GREATER REQUIRE A CENTER SUPPORT. PLEASE CONTACT CUSTOMER SERVICE.

**HOW TO DESIGNATE GROMMET LOCATIONS**

YOU CAN ADD UP TO TWO GROMMETS PER TOP IN THESE STANDARD LOCATIONS AT NO ADDITIONAL CHARGE.  
\* SEE GROMMET LOCATION RESTRICTIONS

**FLUSH MODESTY DESK TOPS**

**RECESSED MODESTY DESK TOPS**



EXAMPLE: WRK-2472WS-FG



EXAMPLE: WRK-2472WS-FGR  
\*DO NOT USE THIS LOCATION  
W/ FLUSH OPEN BOOKCASES

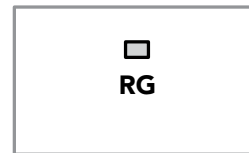

EXAMPLE: WRK-3072WS-RG



EXAMPLE: WRK-3072WS-RGR  
\*DO NOT USE THIS LOCATION  
W/ OPEN BOOKCASES



EXAMPLE: WRK-2472WS-FGL  
\*DO NOT USE THIS LOCATION  
W/ FLUSH OPEN BOOKCASES



EXAMPLE: WRK-2472WS-F2G  
\*DO NOT USE THESE LOCATIONS  
W/ FLUSH OPEN BOOKCASES



EXAMPLE: WRK-3072WS-RGL  
\*DO NOT USE THIS LOCATION  
W/ OPEN BOOKCASES



EXAMPLE: WRK-3072WS-R2G  
\*DO NOT USE THESE LOCATIONS  
W/ OPEN BOOKCASES

| MODEL | LIST | WEIGHT<br>LBS | CUBE<br>FT <sup>3</sup> | W<br>IN | D<br>IN | H<br>IN |
|-------|------|---------------|-------------------------|---------|---------|---------|
|-------|------|---------------|-------------------------|---------|---------|---------|

**20" WORK SURFACE**

|            |       |    |     |       |       |   |
|------------|-------|----|-----|-------|-------|---|
| WRK-2030WS | \$177 | 16 | 0.4 | 29.5  | 19.75 | 1 |
| WRK-2036WS | \$192 | 19 | 0.5 | 35.5  | 19.75 | 1 |
| WRK-2042WS | \$215 | 22 | 0.5 | 41.5  | 19.75 | 1 |
| WRK-2048WS | \$232 | 25 | 0.6 | 47.25 | 19.75 | 1 |
| WRK-2054WS | \$260 | 28 | 0.7 | 53.25 | 19.75 | 1 |

REQUIRES STIFFENER BAR IF UNSUPPORTED 48" OR GREATER SPAN. FOR ORDER DETAILS SEE PAGE [WRK-6](#)

|            |       |    |     |       |       |   |
|------------|-------|----|-----|-------|-------|---|
| WRK-2060WS | \$287 | 31 | 0.8 | 59.25 | 19.75 | 1 |
| WRK-2066WS | \$311 | 34 | 0.8 | 65    | 19.75 | 1 |
| WRK-2072WS | \$322 | 37 | 0.9 | 71    | 19.75 | 1 |

GROMMETS & GROMMET LOCATIONS ARE OPTIONAL. FOR DETAILS PLEASE SEE PAGE [WRK-7](#)

RTA

| MODEL | LIST | WEIGHT | CUBE            | W  | D  | H  |
|-------|------|--------|-----------------|----|----|----|
|       |      | LBS    | FT <sup>3</sup> | IN | IN | IN |

**24" WORK SURFACE**



|            |       |    |     |       |       |   |
|------------|-------|----|-----|-------|-------|---|
| WRK-2430WS | \$189 | 19 | 0.5 | 29.5  | 23.75 | 1 |
| WRK-2436WS | \$204 | 22 | 0.6 | 35.5  | 23.75 | 1 |
| WRK-2442WS | \$225 | 26 | 0.7 | 41.5  | 23.75 | 1 |
| WRK-2448WS | \$246 | 30 | 0.7 | 47.25 | 23.75 | 1 |
| WRK-2454WS | \$265 | 33 | 0.8 | 53.25 | 23.75 | 1 |

- REQUIRES STIFFENER BAR IF UNSUPPORTED 48" OR GREATER SPAN. FOR ORDER DETAILS SEE PAGE [WRK-6](#)

|            |       |    |     |       |       |   |
|------------|-------|----|-----|-------|-------|---|
| WRK-2460WS | \$337 | 37 | 0.9 | 59.25 | 23.75 | 1 |
| WRK-2466WS | \$367 | 41 | 1   | 65    | 23.75 | 1 |
| WRK-2472WS | \$392 | 45 | 1.1 | 71    | 23.75 | 1 |
| WRK-2478WS | \$465 | 48 | 1.2 | 77    | 23.75 | 1 |

- GROMMETS & GROMMET LOCATIONS ARE OPTIONAL. FOR DETAILS PLEASE SEE PAGE [WRK-7](#)

RTA

**30" WORK SURFACE**



|            |       |    |     |       |      |   |
|------------|-------|----|-----|-------|------|---|
| WRK-3048WS | \$285 | 37 | 0.9 | 47.25 | 29.5 | 1 |
| WRK-3054WS | \$337 | 42 | 1   | 53.25 | 29.5 | 1 |

- REQUIRES STIFFENER BAR IF UNSUPPORTED 48" OR GREATER SPAN. FOR ORDER DETAILS SEE PAGE [WRK-6](#)

|            |       |    |     |       |      |   |
|------------|-------|----|-----|-------|------|---|
| WRK-3060WS | \$384 | 47 | 1.1 | 59.25 | 29.5 | 1 |
| WRK-3066WS | \$414 | 51 | 1.3 | 65    | 29.5 | 1 |
| WRK-3072WS | \$437 | 56 | 1.4 | 71    | 29.5 | 1 |
| WRK-3078WS | \$610 | 60 | 1.5 | 77    | 29.5 | 1 |

- GROMMETS & GROMMET LOCATIONS ARE OPTIONAL. FOR DETAILS PLEASE SEE PAGE [WRK-7](#)

RTA

**36" WORK SURFACE**



- REQUIRES STIFFENER BAR IF UNSUPPORTED 48" OR GREATER SPAN. FOR ORDER DETAILS SEE PAGE [WRK-6](#)

|            |       |    |     |       |      |   |
|------------|-------|----|-----|-------|------|---|
| WRK-3660WS | \$525 | 56 | 1.4 | 59.25 | 35.5 | 1 |
| WRK-3666WS | \$580 | 61 | 1.5 | 65    | 35.5 | 1 |
| WRK-3672WS | \$615 | 67 | 1.6 | 71    | 35.5 | 1 |
| WRK-3678WS | \$675 | 72 | 1.8 | 77    | 35.5 | 1 |

- GROMMETS & GROMMET LOCATIONS ARE OPTIONAL. FOR DETAILS PLEASE SEE PAGE [WRK-7](#)

RTA

**WORK SURFACE FLUSH BRACKET KIT**



CONNECTS WORK SURFACE AT 90° TO SAME LEVEL TOPS. INCLUDES 2 BRACKETS W/ SCREWS

|          |      |     |       |
|----------|------|-----|-------|
| WRK-WFBK | \$36 | 0.5 | 0.005 |
|----------|------|-----|-------|

**WORK SURFACE ANGLE BRACKET KIT**

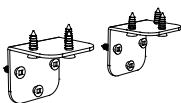

CONNECTS WORK SURFACE TO SIDE OF TALL STORAGE CABINET. INCLUDES 2 BRACKETS W/ SCREWS

|          |      |     |       |
|----------|------|-----|-------|
| WRK-WABK | \$40 | 0.5 | 0.005 |
|----------|------|-----|-------|

| MODEL | LIST | WEIGHT | CUBE            | W  | D  | H  |
|-------|------|--------|-----------------|----|----|----|
|       |      | LBS    | FT <sup>3</sup> | IN | IN | IN |

**METAL RISERS**

**METAL 7" WORK SURFACE RISER**

USE ON 21" HIGH CREDENZA W/ 20" WORK SURFACE

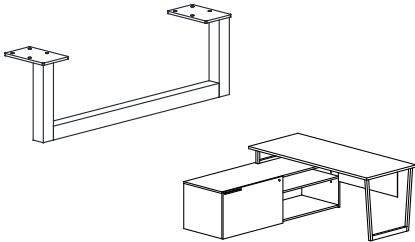

|                  |              |          |            |           |             |          |
|------------------|--------------|----------|------------|-----------|-------------|----------|
| <b>WRK-20MWR</b> | <b>\$148</b> | <b>4</b> | <b>0.2</b> | <b>18</b> | <b>1.25</b> | <b>7</b> |
|------------------|--------------|----------|------------|-----------|-------------|----------|

USE ON 21" HIGH CREDENZA W/ 24" WORK SURFACE

|                  |              |          |            |           |             |          |
|------------------|--------------|----------|------------|-----------|-------------|----------|
| <b>WRK-24MWR</b> | <b>\$172</b> | <b>4</b> | <b>0.3</b> | <b>22</b> | <b>1.25</b> | <b>7</b> |
|------------------|--------------|----------|------------|-----------|-------------|----------|

USE ON 21" HIGH CREDENZA W/ 30" WORK SURFACE

|                  |              |          |            |           |             |          |
|------------------|--------------|----------|------------|-----------|-------------|----------|
| <b>WRK-30MWR</b> | <b>\$195</b> | <b>4</b> | <b>0.3</b> | <b>28</b> | <b>1.25</b> | <b>7</b> |
|------------------|--------------|----------|------------|-----------|-------------|----------|

**AVAILABLE FINISH:** SILVER (SL) OR WHITE (WH) POWDER COAT. **WRK-24MWR** ALSO AVAILABLE IN BLACK.

**LAMINATE RISERS**

**7" LAMINATE WORK SURFACE RISER**

USE ON 21" HIGH CREDENZA W/ 20" WORK SURFACE

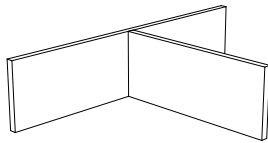

|                  |              |             |             |             |              |          |
|------------------|--------------|-------------|-------------|-------------|--------------|----------|
| <b>WRK-20LWR</b> | <b>\$157</b> | <b>4.56</b> | <b>0.26</b> | <b>19.5</b> | <b>17.75</b> | <b>7</b> |
|------------------|--------------|-------------|-------------|-------------|--------------|----------|

USE ON 21" HIGH CREDENZA W/ 24" WORK SURFACE

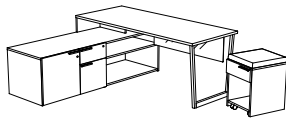

|                  |              |             |             |             |              |          |
|------------------|--------------|-------------|-------------|-------------|--------------|----------|
| <b>WRK-24LWR</b> | <b>\$167</b> | <b>5.11</b> | <b>0.31</b> | <b>23.5</b> | <b>17.75</b> | <b>7</b> |
|------------------|--------------|-------------|-------------|-------------|--------------|----------|

USE ON 21" HIGH CREDENZA W/ 30" WORK SURFACE

|                  |              |             |             |             |              |          |
|------------------|--------------|-------------|-------------|-------------|--------------|----------|
| <b>WRK-30LWR</b> | <b>\$175</b> | <b>5.91</b> | <b>0.38</b> | <b>29.5</b> | <b>17.75</b> | <b>7</b> |
|------------------|--------------|-------------|-------------|-------------|--------------|----------|

**SPACERS**

**METAL 1" WORK SURFACE SPACER**

USE ON 27" HIGH CREDENZA W/ 20" WORK SURFACE

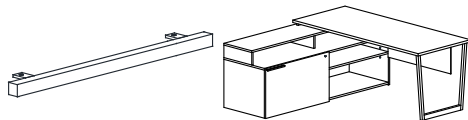

|                  |             |          |            |           |          |          |
|------------------|-------------|----------|------------|-----------|----------|----------|
| <b>WRK-20MWS</b> | <b>\$93</b> | <b>4</b> | <b>0.1</b> | <b>18</b> | <b>1</b> | <b>1</b> |
|------------------|-------------|----------|------------|-----------|----------|----------|

USE ON 27" HIGH CREDENZA W/ 24" WORK SURFACE

|                  |              |          |            |           |          |          |
|------------------|--------------|----------|------------|-----------|----------|----------|
| <b>WRK-24MWS</b> | <b>\$119</b> | <b>4</b> | <b>0.1</b> | <b>22</b> | <b>1</b> | <b>1</b> |
|------------------|--------------|----------|------------|-----------|----------|----------|

USE ON 27" HIGH CREDENZA W/ 30" WORK SURFACE

|                  |              |          |            |           |          |          |
|------------------|--------------|----------|------------|-----------|----------|----------|
| <b>WRK-30MWS</b> | <b>\$143</b> | <b>4</b> | <b>0.2</b> | <b>28</b> | <b>1</b> | <b>1</b> |
|------------------|--------------|----------|------------|-----------|----------|----------|

**AVAILABLE FINISH:** SILVER (SL) POWDER COAT. **WRK-24MWS** ALSO AVAILABLE IN BLACK.

**WORKSCAPE WORK SURFACE SUPPORT  
METAL LEGS**

| MODEL | LIST | WEIGHT | CUBE            | W  | D  | H  |
|-------|------|--------|-----------------|----|----|----|
|       |      | LBS    | FT <sup>3</sup> | IN | IN | IN |

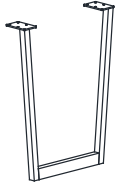

**METAL V-LEG**

USE W/ 20" WORK SURFACE

|                    |              |   |     |    |      |    |
|--------------------|--------------|---|-----|----|------|----|
| <b>WRK-20MVLEG</b> | <b>\$195</b> | 7 | 0.8 | 18 | 1.25 | 28 |
|--------------------|--------------|---|-----|----|------|----|

USE W/ 24" WORK SURFACE

|                    |              |   |   |    |      |    |
|--------------------|--------------|---|---|----|------|----|
| <b>WRK-24MVLEG</b> | <b>\$219</b> | 7 | 1 | 22 | 1.25 | 28 |
|--------------------|--------------|---|---|----|------|----|

USE W/ 30" WORK SURFACE

|                    |              |   |     |    |      |    |
|--------------------|--------------|---|-----|----|------|----|
| <b>WRK-30MVLEG</b> | <b>\$250</b> | 8 | 1.3 | 28 | 1.25 | 28 |
|--------------------|--------------|---|-----|----|------|----|

**AVAILABLE FINISH:** SILVER (SL) OR WHITE (WH) POWDER COAT

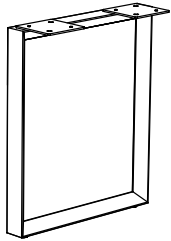

**METAL LOOP LEGS**

USE W/ 24" TOP OR WORK SURFACE

|                   |              |      |     |   |      |    |
|-------------------|--------------|------|-----|---|------|----|
| <b>900-LOOP24</b> | <b>\$188</b> | 16.5 | 1.3 | 3 | 23.5 | 28 |
|-------------------|--------------|------|-----|---|------|----|

USE W/ 30" TOP OR WORK SURFACE

|                   |              |      |     |   |      |    |
|-------------------|--------------|------|-----|---|------|----|
| <b>900-LOOP30</b> | <b>\$207</b> | 18.7 | 1.6 | 3 | 29.5 | 28 |
|-------------------|--------------|------|-----|---|------|----|

**AVAILABLE FINISH:** BLACK (BL), SILVER (SL) & WHITE (WH)

- 1 PER CARTON. INCLUDES LEVELER.

| MODEL | LIST | WEIGHT | CUBE            | W  | D  | H  |
|-------|------|--------|-----------------|----|----|----|
|       |      | LBS    | FT <sup>3</sup> | IN | IN | IN |

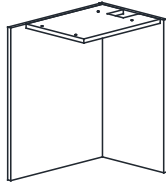

LEFT

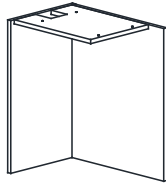

RIGHT

**RTA**

**END SUPPORT GABLE**

USE W/ 20" WORK SURFACE

|                      |              |           |            |              |              |           |
|----------------------|--------------|-----------|------------|--------------|--------------|-----------|
| <b>WRK-1620ESG-L</b> | <b>\$142</b> | <b>26</b> | <b>0.7</b> | <b>15.75</b> | <b>19.75</b> | <b>28</b> |
| <b>WRK-1620ESG-R</b> | <b>\$142</b> | <b>26</b> | <b>0.7</b> | <b>15.75</b> | <b>19.75</b> | <b>28</b> |

USE W/ 24" OR 30" WORK SURFACE. FLUSH ON 24" WORK SURFACE 6" OVERHANG ON 30" WORK SURFACE

|                      |              |           |            |              |              |           |
|----------------------|--------------|-----------|------------|--------------|--------------|-----------|
| <b>WRK-1624ESG-L</b> | <b>\$157</b> | <b>29</b> | <b>0.9</b> | <b>15.75</b> | <b>23.75</b> | <b>28</b> |
| <b>WRK-1624ESG-R</b> | <b>\$157</b> | <b>29</b> | <b>0.9</b> | <b>15.75</b> | <b>23.75</b> | <b>28</b> |

USE W/ 30" OR 36" WORK SURFACE. FLUSH ON 30" WORK SURFACE 6" OVERHANG ON 36" WORK SURFACE

|                      |              |           |            |              |             |           |
|----------------------|--------------|-----------|------------|--------------|-------------|-----------|
| <b>WRK-1630ESG-L</b> | <b>\$169</b> | <b>35</b> | <b>1.1</b> | <b>15.75</b> | <b>29.5</b> | <b>28</b> |
| <b>WRK-1630ESG-R</b> | <b>\$169</b> | <b>35</b> | <b>1.1</b> | <b>15.75</b> | <b>29.5</b> | <b>28</b> |

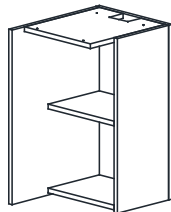

LEFT

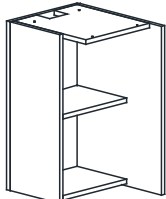

RIGHT

**RTA**

**STORAGE GABLE W/ 1 FIXED SHELF**

USE W/ 20" WORK SURFACE

|                     |              |           |            |              |              |           |
|---------------------|--------------|-----------|------------|--------------|--------------|-----------|
| <b>WRK-1620SG-L</b> | <b>\$422</b> | <b>33</b> | <b>0.7</b> | <b>15.75</b> | <b>19.75</b> | <b>28</b> |
| <b>WRK-1620SG-R</b> | <b>\$422</b> | <b>33</b> | <b>0.7</b> | <b>15.75</b> | <b>19.75</b> | <b>28</b> |

USE W/ 24" OR 30" WORK SURFACE. FLUSH ON 24" WORK SURFACE 6" OVERHANG ON 30" WORK SURFACE

|                     |              |           |            |              |              |           |
|---------------------|--------------|-----------|------------|--------------|--------------|-----------|
| <b>WRK-1624SG-L</b> | <b>\$449</b> | <b>39</b> | <b>0.9</b> | <b>15.75</b> | <b>23.75</b> | <b>28</b> |
| <b>WRK-1624SG-R</b> | <b>\$449</b> | <b>39</b> | <b>0.9</b> | <b>15.75</b> | <b>23.75</b> | <b>28</b> |

USE W/ 30" OR 36" WORK SURFACE. FLUSH ON 30" WORK SURFACE 6" OVERHANG ON 36" WORK SURFACE

|                     |              |           |            |              |             |           |
|---------------------|--------------|-----------|------------|--------------|-------------|-----------|
| <b>WRK-1630SG-L</b> | <b>\$475</b> | <b>49</b> | <b>1.1</b> | <b>15.75</b> | <b>29.5</b> | <b>28</b> |
| <b>WRK-1630SG-R</b> | <b>\$475</b> | <b>49</b> | <b>1.1</b> | <b>15.75</b> | <b>29.5</b> | <b>28</b> |



**STORAGE GABLE HINGED DOOR**

NON-HANDED AND INCLUDES LOCK

|                 |              |            |            |           |             |              |
|-----------------|--------------|------------|------------|-----------|-------------|--------------|
| <b>WRK-SGHD</b> | <b>\$162</b> | <b>0.6</b> | <b>0.2</b> | <b>15</b> | <b>0.75</b> | <b>26.75</b> |
|-----------------|--------------|------------|------------|-----------|-------------|--------------|

**OPEN BOOKCASES- NO TOP**

**OPEN BOOKCASES- NO TOP USE W/ 20" WORK SURFACE**

USE W/ 20" WORK SURFACE

|                    |              |           |            |              |              |           |
|--------------------|--------------|-----------|------------|--------------|--------------|-----------|
| <b>WRK-1620BKX</b> | <b>\$598</b> | <b>36</b> | <b>0.7</b> | <b>19.75</b> | <b>15.75</b> | <b>28</b> |
|--------------------|--------------|-----------|------------|--------------|--------------|-----------|

USE W/ 24" OR 30" WORK SURFACE. FLUSH ON 24" WORK SURFACE 6" OVERHANG ON 30" WORK SURFACE

|                    |              |           |            |              |              |           |
|--------------------|--------------|-----------|------------|--------------|--------------|-----------|
| <b>WRK-1624BKX</b> | <b>\$614</b> | <b>40</b> | <b>0.9</b> | <b>23.75</b> | <b>15.75</b> | <b>28</b> |
|--------------------|--------------|-----------|------------|--------------|--------------|-----------|

USE W/ 30" OR 36" WORK SURFACE. FLUSH ON 30" WORK SURFACE 6" OVERHANG ON 36" WORK SURFACE

|                    |              |           |            |             |              |           |
|--------------------|--------------|-----------|------------|-------------|--------------|-----------|
| <b>WRK-1630BKX</b> | <b>\$636</b> | <b>46</b> | <b>1.1</b> | <b>29.5</b> | <b>15.75</b> | <b>28</b> |
|--------------------|--------------|-----------|------------|-------------|--------------|-----------|

USE W/ 36" WORK SURFACE

|                    |              |           |            |             |              |           |
|--------------------|--------------|-----------|------------|-------------|--------------|-----------|
| <b>WRK-1636BKX</b> | <b>\$656</b> | <b>59</b> | <b>1.3</b> | <b>35.5</b> | <b>15.75</b> | <b>28</b> |
|--------------------|--------------|-----------|------------|-------------|--------------|-----------|

**RTA**

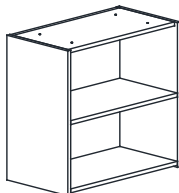

# WORKSCAPE PEDESTALS

## FREESTANDING PEDESTALS

| MODEL | LIST | WEIGHT | CUBE            | W  | D  | H  |
|-------|------|--------|-----------------|----|----|----|
|       |      | LBS    | FT <sup>3</sup> | IN | IN | IN |

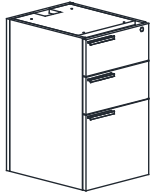

HANDLES LEFT (L)

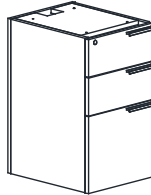

HANDLES RIGHT (R)

### FREESTANDING BOX/BOX/FILE, NO TOP PEDESTAL

BOX/BOX/FILE, NO TOP PEDESTAL. ALL DRAWERS LOCK. USE W/ 20" WORK SURFACE. ALL DRAWERS LOCK.

|                 |       |    |     |       |       |    |
|-----------------|-------|----|-----|-------|-------|----|
| WRK-1620FPUFX-L | \$837 | 70 | 5.1 | 15.75 | 19.75 | 28 |
| WRK-1620FPUFX-R | \$837 | 70 | 5.1 | 15.75 | 19.75 | 28 |

USE W/ 24" OR 30" WORK SURFACE. FLUSH ON 24" WORK SURFACE. 6" OVERHANG ON 30" WORK SURFACE. ALL DRAWERS LOCK.

|                 |       |    |     |       |       |    |
|-----------------|-------|----|-----|-------|-------|----|
| WRK-1624FPUFX-L | \$851 | 74 | 6.1 | 15.75 | 23.75 | 28 |
| WRK-1624FPUFX-R | \$851 | 74 | 6.1 | 15.75 | 23.75 | 28 |

USE W/ 30" OR 36" WORK SURFACE. FLUSH ON 30" WORK SURFACE. 6" OVERHANG ON 36" WORK SURFACE. ALL DRAWERS LOCK.

|                 |       |    |     |       |      |    |
|-----------------|-------|----|-----|-------|------|----|
| WRK-1630FPUFX-L | \$863 | 81 | 7.7 | 15.75 | 29.5 | 28 |
| WRK-1630FPUFX-R | \$863 | 81 | 7.7 | 15.75 | 29.5 | 28 |



HANDLES LEFT (L)

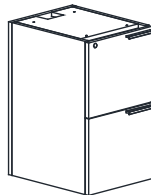

HANDLES RIGHT (R)

### FREESTANDING FILE/FILE, NO TOP PEDESTAL

FILE/FILE/TOP, NO TOP PEDESTAL. ALL DRAWERS LOCK. USE W/ 20" WORK SURFACE.

|                 |       |    |     |       |       |    |
|-----------------|-------|----|-----|-------|-------|----|
| WRK-1620FPFFX-L | \$872 | 70 | 5.1 | 15.75 | 19.75 | 28 |
| WRK-1620FPFFX-R | \$872 | 70 | 5.1 | 15.75 | 19.75 | 28 |

USE W/ 24" OR 30" WORK SURFACE. FLUSH ON 24" WORK SURFACE. 6" OVERHANG ON 30" WORK SURFACE. ALL DRAWERS LOCK.

|                 |       |    |     |       |       |    |
|-----------------|-------|----|-----|-------|-------|----|
| WRK-1624FPFFX-L | \$882 | 74 | 6.1 | 15.75 | 23.75 | 28 |
| WRK-1624FPFFX-R | \$882 | 74 | 6.1 | 15.75 | 23.75 | 28 |

USE W/ 30" OR 36" WORK SURFACE. FLUSH ON 30" WORK SURFACE. 6" OVERHANG ON 36" WORK SURFACE.

|                 |       |    |     |       |      |    |
|-----------------|-------|----|-----|-------|------|----|
| WRK-1630FPFFX-L | \$885 | 81 | 7.7 | 15.75 | 29.5 | 28 |
| WRK-1630FPFFX-R | \$885 | 81 | 7.7 | 15.75 | 29.5 | 28 |

## MOBILE PEDESTALS



HANDLES LEFT (L)  
WRK-1621MPF-L

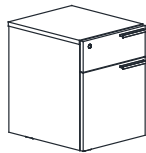

HANDLES RIGHT (R)  
WRK-1621MPF-R

### 21" MOBILE PEDESTAL

BOX/FILE. ALL DRAWERS LOCK. HIDDEN CASTERS

|               |       |    |   |    |       |    |
|---------------|-------|----|---|----|-------|----|
| WRK-1621MPF-L | \$800 | 65 | 5 | 16 | 18.75 | 21 |
| WRK-1621MPF-R | \$800 | 65 | 5 | 16 | 18.75 | 21 |

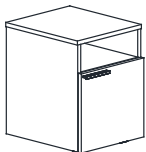

HANDLES LEFT (L)  
WRK-1621MPOF-L

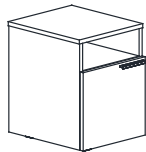

HANDLES RIGHT (R)  
WRK-1621MPOF-R

OPEN SHELF/FILE. DRAWER DOES NOT LOCK. HIDDEN CASTERS

|                |       |    |   |    |       |    |
|----------------|-------|----|---|----|-------|----|
| WRK-1621MPOF-L | \$696 | 65 | 5 | 16 | 18.75 | 21 |
| WRK-1621MPOF-R | \$696 | 65 | 5 | 16 | 18.75 | 21 |

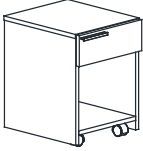
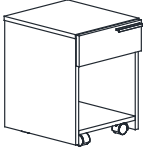
| MODEL   | LIST  | WEIGHT    | CUBE            | W         | D            | H         |
|---|---|-----------|-----------------|-----------|--------------|-----------|
|   |   | LBS       | FT <sup>3</sup> | IN        | IN           | IN        |
| <b>21" MOBILE PEDESTAL</b>  |   |           |                 |           |              |           |
| BOX/OPEN SHELF. DRAWER DOES NOT LOCK.   |   |           |                 |           |              |           |
|  |  |           |                 |           |              |           |
| HANDLES LEFT (L)<br>WRK-1621MPBO-L  | HANDLES RIGHT (R)<br>WRK-1621MPBO-R   |           |                 |           |              |           |
| <b>WRK-1621MPBO-L</b>   | <b>\$674</b>  | <b>65</b> | <b>5</b>        | <b>16</b> | <b>18.75</b> | <b>21</b> |
| <b>WRK-1621MPBO-R</b>   | <b>\$674</b>  | <b>65</b> | <b>5</b>        | <b>16</b> | <b>18.75</b> | <b>21</b> |

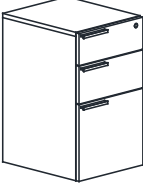
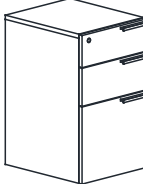
|   |   |           |          |           |              |              |
|---|---|-----------|----------|-----------|--------------|--------------|
| <b>27" MOBILE PEDESTAL</b>  |   |           |          |           |              |              |
| BOX/BOX/FILE. ALL DRAWERS LOCK.<br>HIDDEN CASTERS                                 |   |           |          |           |              |              |
|  |  |           |          |           |              |              |
| HANDLES LEFT (L)<br>WRK-1627MPUF-L  | HANDLES RIGHT (R)<br>WRK-1627MPUF-R   |           |          |           |              |              |
| <b>WRK-1627MPUF-L</b>   | <b>\$965</b>  | <b>75</b> | <b>7</b> | <b>16</b> | <b>18.75</b> | <b>26.75</b> |
| <b>WRK-1627MPUF-R</b>   | <b>\$965</b>  | <b>75</b> | <b>7</b> | <b>16</b> | <b>18.75</b> | <b>26.75</b> |

**WORKSPACE SEAT CUSHIONS**

**SEAT CUSHIONS FOR MOBILE PEDESTALS & 21" HIGH CREDENZAS**

| MODEL               | USE ON                    | LIST         |              |               |           |          |              |           |             |
|---------------------|---------------------------|--------------|--------------|---------------|-----------|----------|--------------|-----------|-------------|
|                     |                           | ESCAPE       | HEAVENLY     | ULTRA LEATHER |           |          |              |           |             |
| <b>WRK-MPEDCUSH</b> | 21" HIGH MOBILE PEDESTALS | <b>\$393</b> | <b>\$424</b> | <b>\$456</b>  | <b>4</b>  | <b>1</b> | <b>16</b>    | <b>18</b> | <b>1.75</b> |
| <b>WRK-2030CUSH</b> | 20 X 60" CREDENZA         | <b>\$457</b> | <b>\$476</b> | <b>\$519</b>  | <b>8</b>  | <b>2</b> | <b>29.75</b> | <b>19</b> | <b>1.75</b> |
| <b>WRK-2036CUSH</b> | 20 X 72" CREDENZA         | <b>\$457</b> | <b>\$476</b> | <b>\$519</b>  | <b>10</b> | <b>2</b> | <b>35.5</b>  | <b>19</b> | <b>1.75</b> |
| <b>WRK-2430CUSH</b> | 24 X 60" CREDENZA         | <b>\$525</b> | <b>\$562</b> | <b>\$569</b>  | <b>10</b> | <b>2</b> | <b>29.75</b> | <b>23</b> | <b>1.75</b> |
| <b>WRK-2436CUSH</b> | 24 X 72" CREDENZA         | <b>\$525</b> | <b>\$562</b> | <b>\$569</b>  | <b>12</b> | <b>2</b> | <b>35.5</b>  | <b>23</b> | <b>1.75</b> |

SEE PAGE WRK-14 FOR CREDENZAS

- |                     |   |                      |                           |
|---------------------|---|----------------------|---------------------------|
| <b>ESCAPE</b>       | - 100% POLYESTER, JACQUARD WOVEN<br>- 100% POLYESTER, SOLID PLAIN WEAVE | ADD '-ESC' TO ITEM # | EXAMPLE: WRK-2430CUSH-ESC |
| <b>HEAVENLY</b>     | - 20% RAYON 80% POLYESTER, SOLID PLAIN WEAVE                            | ADD '-HEA' TO ITEM # | EXAMPLE: WRK-2430CUSH-HEA |
| <b>ULTRALEATHER</b> | - 100% POLYVINYL CHLORIDE, FAUX LEATHER,<br>ANTI-BACTERIAL              | ADD '-ULT' TO ITEM # | EXAMPLE: WRK-2430CUSH-ULT |

**NOTES:** PLEASE REFER TO THE FINISHES & FABRICS TAB ON THE WWW.HEARTWOOD.CA WEBSITE FOR A COMPLETE LISTING OF THE COLOUR CHOICES AVAILABLE IN EACH FABRIC. CONTACT CUSTOMER SERVICE IF TWO SEAT CUSHIONS ARE REQUIRED TO BE SIDE BY SIDE AS SIZING MAY NEED TO BE ADJUSTED.

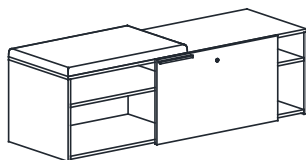

\*OPTIONAL SEAT CUSHION  
**EXAMPLE: WRK-2430CUSH-ULT**

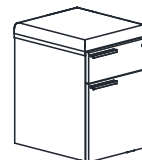

\*OPTIONAL SEAT CUSHION  
**EXAMPLE: WRK-MPEDCUSH-ESC**

# WORKSPACE MODESTY & DIVIDER PANELS

## LAMINATE MODESTY PANELS

| MODEL | LIST | WEIGHT | CUBE            | W  | D  | H  |
|-------|------|--------|-----------------|----|----|----|
|       |      | LBS    | FT <sup>3</sup> | IN | IN | IN |

### LAMINATE ½ HEIGHT MODESTY PANELS - SUSPENDED

INCLUDES ALL MOUNTING HARDWARE.

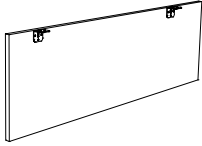

|              |       |    |     |       |      |      |
|--------------|-------|----|-----|-------|------|------|
| WRK-1424LMPS | \$172 | 7  | 0.2 | 23.75 | 0.75 | 13.5 |
| WRK-1430LMPS | \$175 | 8  | 0.2 | 29.5  | 0.75 | 13.5 |
| WRK-1436LMPS | \$189 | 10 | 0.2 | 35.5  | 0.75 | 13.5 |
| WRK-1442LMPS | \$215 | 11 | 0.3 | 41.5  | 0.75 | 13.5 |
| WRK-1448LMPS | \$222 | 13 | 0.3 | 47.25 | 0.75 | 13.5 |
| WRK-1454LMPS | \$227 | 14 | 0.3 | 53.25 | 0.75 | 13.5 |
| WRK-1460LMPS | \$241 | 16 | 0.4 | 59.25 | 0.75 | 13.5 |

RTA

### LAMINATE ¾ HEIGHT MODESTY PANELS - FIXED

INCLUDES ALL MOUNTING HARDWARE.

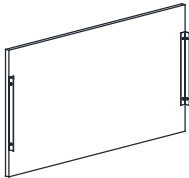

|             |       |    |     |       |      |       |
|-------------|-------|----|-----|-------|------|-------|
| WRK-2134FMP | \$207 | 14 | 0.3 | 33.5  | 0.75 | 20.75 |
| WRK-2140FMP | \$222 | 16 | 0.4 | 39.5  | 0.75 | 20.75 |
| WRK-2146FMP | \$233 | 19 | 0.4 | 45.5  | 0.75 | 20.75 |
| WRK-2152FMP | \$247 | 21 | 0.5 | 51.25 | 0.75 | 20.75 |

- MODESTY PANEL MUST ATTACH TO UNITS WITH FULL GABLES AND SECURED ON BOTH ENDS.

RTA

## ALUMINUM GLAZED MODESTY PANELS

### ALUMINUM GLAZED ¾ HEIGHT MODESTY PANELS - FIXED

INCLUDES ALL MOUNTING HARDWARE.

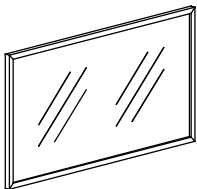

|             |       |    |     |       |      |       |
|-------------|-------|----|-----|-------|------|-------|
| WRK-2134AGM | \$676 | 14 | 0.3 | 33.5  | 0.75 | 20.75 |
| WRK-2140AGM | \$742 | 16 | 0.4 | 39.5  | 0.75 | 20.75 |
| WRK-2146AGM | \$806 | 19 | 0.4 | 45.5  | 0.75 | 20.75 |
| WRK-2152AGM | \$962 | 21 | 0.5 | 51.25 | 0.75 | 20.75 |

- MODESTY PANEL MUST ATTACH TO UNITS WITH FULL GABLES AND SECURED ON BOTH ENDS.

RTA

## PLEXI MODESTY/DIVIDER PANELS

### PLEXI ½ HEIGHT MODESTY PANELS - SUSPENDED

INCLUDES ALL MOUNTING HARDWARE.

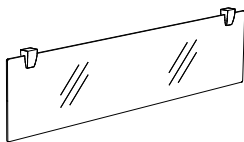

|              |       |   |     |       |      |      |
|--------------|-------|---|-----|-------|------|------|
| WRK-1424PMPS | \$241 | 4 | 0.1 | 23.75 | 0.25 | 13.5 |
| WRK-1430PMPS | \$260 | 4 | 0.1 | 29.5  | 0.25 | 13.5 |
| WRK-1436PMPS | \$299 | 5 | 0.1 | 35.5  | 0.25 | 13.5 |
| WRK-1442PMPS | \$332 | 6 | 0.1 | 41.5  | 0.25 | 13.5 |
| WRK-1448PMPS | \$411 | 7 | 0.1 | 47.25 | 0.25 | 13.5 |
| WRK-1454PMPS | \$436 | 7 | 0.1 | 53.25 | 0.25 | 13.5 |
| WRK-1460PMPS | \$471 | 8 | 0.1 | 59.25 | 0.25 | 13.5 |

RTA



| MODEL | LIST | WEIGHT | CUBE            | W  | D  | H  |
|-------|------|--------|-----------------|----|----|----|
|       |      | LBS    | FT <sup>3</sup> | IN | IN | IN |

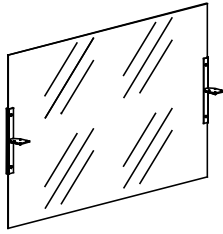

**RTA**

**PLEXI MODESTY PANEL/DIVIDERS - SUSPENDED**

INCLUDES ALL MOUNTING HARDWARE.

|               |       |    |     |       |      |      |
|---------------|-------|----|-----|-------|------|------|
| WRK-2830PMPDS | \$417 | 8  | 0.1 | 29.5  | 0.25 | 26.5 |
| WRK-2836PMPDS | \$477 | 10 | 0.2 | 35.5  | 0.25 | 26.5 |
| WRK-2842PMPDS | \$541 | 11 | 0.2 | 41.5  | 0.25 | 26.5 |
| WRK-2848PMPDS | \$613 | 13 | 0.2 | 47.25 | 0.25 | 26.5 |
| WRK-2854PMPDS | \$676 | 14 | 0.2 | 53.25 | 0.25 | 26.5 |
| WRK-2860PMPDS | \$741 | 16 | 0.2 | 59.25 | 0.25 | 26.5 |

- CONTACT CUSTOMER SERVICE FOR SIZING WHEN PAIRING WITH LOOP LEGS

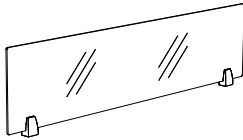

**RTA**

**PLEXI DIVIDER PANELS**

INCLUDES ALL MOUNTING HARDWARE.

|             |       |   |     |       |      |    |
|-------------|-------|---|-----|-------|------|----|
| WRK-1224PDP | \$241 | 3 | 0.1 | 23.75 | 0.25 | 12 |
| WRK-1230PDP | \$260 | 4 | 0.1 | 29.5  | 0.25 | 12 |
| WRK-1236PDP | \$299 | 5 | 0.1 | 35.5  | 0.25 | 12 |
| WRK-1242PDP | \$332 | 5 | 0.1 | 41.5  | 0.25 | 12 |
| WRK-1248PDP | \$411 | 6 | 0.1 | 47.25 | 0.25 | 12 |
| WRK-1254PDP | \$436 | 7 | 0.1 | 53.25 | 0.25 | 12 |
| WRK-1260PDP | \$471 | 7 | 0.1 | 59.25 | 0.25 | 12 |

**WORKSPACE STORAGE CABINETS**  
**NO-TOP CABINETS**

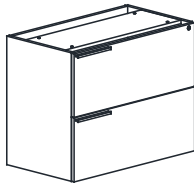

HANDLES LEFT (L)

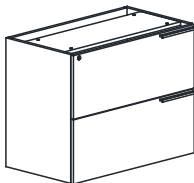

HANDLES RIGHT (R)

**LATERAL FILE- 20" DEEP- NO TOP**

FITS UNDER WORK SURFACE. LATERAL FILE DRAWERS LOCK.

|               |         |     |    |      |      |    |
|---------------|---------|-----|----|------|------|----|
| WRK-2030LFX-L | \$1,002 | 105 | 13 | 29.5 | 19.5 | 28 |
| WRK-2030LFX-R | \$1,002 | 105 | 13 | 29.5 | 19.5 | 28 |
| WRK-2036LFX-L | \$1,035 | 117 | 15 | 35.5 | 19.5 | 28 |
| WRK-2036LFX-R | \$1,035 | 117 | 15 | 35.5 | 19.5 | 28 |

**LATERAL FILE- 24" DEEP- NO TOP**

FITS UNDER WORK SURFACE. LATERAL FILE DRAWERS LOCK.

|               |         |     |    |      |      |    |
|---------------|---------|-----|----|------|------|----|
| WRK-2430LFX-L | \$1,021 | 112 | 15 | 29.5 | 23.5 | 28 |
| WRK-2430LFX-R | \$1,021 | 112 | 15 | 29.5 | 23.5 | 28 |
| WRK-2436LFX-L | \$1,054 | 123 | 18 | 35.5 | 23.5 | 28 |
| WRK-2436LFX-R | \$1,054 | 123 | 18 | 35.5 | 23.5 | 28 |

# WORKSCAPE STORAGE CABINETS

## NO-TOP CABINETS

| MODEL | LIST | AGD        | WEIGHT | CUBE            | W  | D  | H  |
|-------|------|------------|--------|-----------------|----|----|----|
|       |      | *UP-CHARGE | LBS    | FT <sup>3</sup> | IN | IN | IN |

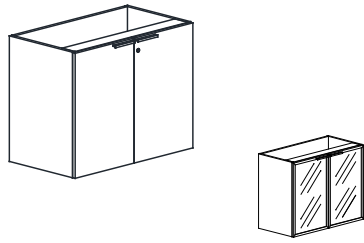

Optional AGD example:  
WRK-2036CX-AGD-FR

### \*\* OPTIONAL ALUMINUM GLAZED DOORS \*\*

- SELECT CLEAR (CL), FROSTED (FR) OR BRONZE (BR) PLEXI GLASS
- SEE EXAMPLES ABOVE

### DOUBLE DOOR CABINETS- NO TOP

20" DEEP. FITS UNDER WORK SURFACE W/ 1 ADJUSTABLE SHELF. HINGED CABINET DOORS LOCK.

|            |       |       |    |    |      |      |    |
|------------|-------|-------|----|----|------|------|----|
| WRK-2030CX | \$806 | \$532 | 85 | 13 | 29.5 | 19.5 | 28 |
| WRK-2036CX | \$833 | \$544 | 97 | 15 | 35.5 | 19.5 | 28 |

24" DEEP. FITS UNDER WORK SURFACE W/ 1 ADJUSTABLE SHELF. HINGED CABINET DOORS LOCK.

|            |       |       |     |    |      |      |    |
|------------|-------|-------|-----|----|------|------|----|
| WRK-2430CX | \$826 | \$532 | 92  | 15 | 29.5 | 23.5 | 28 |
| WRK-2436CX | \$845 | \$544 | 103 | 18 | 35.5 | 23.5 | 28 |

- AGD DOORS INCLUDE SILVER FINISH BAR HANDLES.
- PLEASE REFER TO 100 SERIES (ACC) PAGE [100-3](#) FOR OTHER HANDLE CHOICES.
- \* THE PRICE SHOWN FOR AGD DOORS IS AN UP-CHARGE THAT MUST BE ADDED TO THE BASE PRICE OF THE UNIT IT GOES ON.

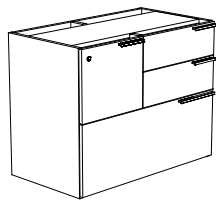

WRK-2036FULX

### FILE/BOX/BOX LATERAL FILE COMBO UNITS- HANDLES RIGHT- NO TOP

20" DEEP. FITS UNDER WORK SURFACE. LATERAL FILE & FILE DRAWERS LOCK. INCLUDES PENCIL TRAY.

|              |         |  |     |    |      |      |    |
|--------------|---------|--|-----|----|------|------|----|
| WRK-2030FULX | \$1,255 |  | 105 | 13 | 29.5 | 19.5 | 28 |
| WRK-2036FULX | \$1,339 |  | 117 | 15 | 35.5 | 19.5 | 28 |

24" DEEP. FITS UNDER WORK SURFACE. LATERAL FILE & FILE DRAWERS LOCK. INCLUDES PENCIL TRAY.

|              |         |  |     |    |      |      |    |
|--------------|---------|--|-----|----|------|------|----|
| WRK-2430FULX | \$1,274 |  | 112 | 15 | 29.5 | 23.5 | 28 |
| WRK-2436FULX | \$1,359 |  | 123 | 18 | 35.5 | 23.5 | 28 |

### BOX/BOX/FILE LATERAL FILE COMBO UNITS- HANDLES LEFT- NO TOP

20" DEEP. FITS UNDER WORK SURFACE. LATERAL FILE & FILE DRAWERS LOCK.

|              |         |  |     |    |      |      |    |
|--------------|---------|--|-----|----|------|------|----|
| WRK-2030UFLX | \$1,255 |  | 105 | 13 | 29.5 | 19.5 | 28 |
| WRK-2036UFLX | \$1,339 |  | 117 | 15 | 35.5 | 19.5 | 28 |

24" DEEP. FITS UNDER WORK SURFACE. LATERAL FILE & FILE DRAWERS LOCK. INCLUDES PENCIL TRAY.

|              |         |  |     |    |      |      |    |
|--------------|---------|--|-----|----|------|------|----|
| WRK-2430UFLX | \$1,274 |  | 112 | 15 | 29.5 | 23.5 | 28 |
| WRK-2436UFLX | \$1,359 |  | 123 | 18 | 35.5 | 23.5 | 28 |

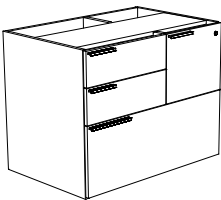

WRK-2436UFLX

| MODEL | LIST | AGD        | WEIGHT | CUBE            | W  | D  | H  |
|-------|------|------------|--------|-----------------|----|----|----|
|       |      | *UP-CHARGE | LBS    | FT <sup>3</sup> | IN | IN | IN |

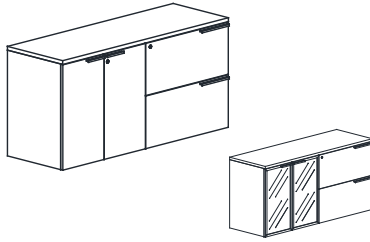

Optional AGD example:  
WRK-C2060LF-AGD-FR

**29" HIGH CABINET/LATERAL FILE CREDENZAS**

20" DEEP W/ 1 ADJUSTABLE SHELF. HINGED CABINET DOORS AND LATERAL FILE DRAWERS LOCK.

|             |         |       |     |    |       |       |    |
|-------------|---------|-------|-----|----|-------|-------|----|
| WRK-C2060LF | \$1,814 | \$532 | 230 | 25 | 59.25 | 19.75 | 29 |
| WRK-C2072LF | \$2,114 | \$544 | 240 | 30 | 71    | 19.75 | 29 |

24" DEEP W/ 1 ADJUSTABLE SHELF. HINGED CABINET DOORS AND LATERAL FILE DRAWERS LOCK.

|             |         |       |     |    |       |       |    |
|-------------|---------|-------|-----|----|-------|-------|----|
| WRK-C2460LF | \$1,873 | \$532 | 247 | 30 | 59.25 | 23.75 | 29 |
| WRK-C2472LF | \$2,177 | \$544 | 259 | 36 | 71    | 23.75 | 29 |

**29" HIGH LATERAL FILE/CABINET CREDENZAS**

20" DEEP W/ 1 ADJUSTABLE SHELF. HINGED CABINET DOORS AND LATERAL FILE DRAWERS LOCK.

|             |         |       |     |    |       |       |    |
|-------------|---------|-------|-----|----|-------|-------|----|
| WRK-LF2060C | \$1,814 | \$532 | 230 | 25 | 59.25 | 19.75 | 29 |
| WRK-LF2072C | \$2,114 | \$544 | 240 | 30 | 71    | 19.75 | 29 |

24" DEEP W/ 1 ADJUSTABLE SHELF. HINGED CABINET DOORS AND LATERAL FILE DRAWERS LOCK.

|             |         |       |     |    |       |       |    |
|-------------|---------|-------|-----|----|-------|-------|----|
| WRK-LF2460C | \$1,873 | \$532 | 247 | 30 | 59.25 | 23.75 | 29 |
| WRK-LF2472C | \$2,177 | \$544 | 259 | 36 | 71    | 23.75 | 29 |

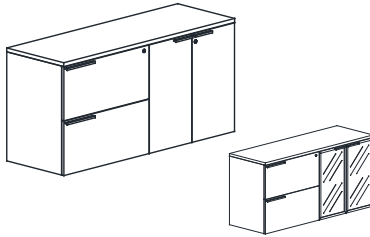

Optional AGD example:  
WRK-LF2060C-AGD-FR

**\*\* OPTIONAL ALUMINUM GLAZED DOORS \*\***

- SELECT CLEAR (CL), FROSTED (FR) OR BRONZE (BR) PLEXI GLASS
- SEE EXAMPLES ABOVE

- AGD DOORS INCLUDE SILVER FINISH BAR HANDLES.
- PLEASE REFER TO 100 SERIES (ACC) PAGE 100-3 FOR OTHER HANDLE CHOICES.
- \* THE PRICE SHOWN FOR AGD DOORS IS AN UP-CHARGE THAT MUST BE ADDED TO THE BASE PRICE OF THE UNIT IT GOES ON.

**29" HIGH CABINET, BOX/BOX/WIDE DRAWER/LATERAL FILE CREDENZAS**

20" DEEP W/ 1 ADJUSTABLE SHELF. HINGED CABINET DOORS, LATERAL FILE, LEFT BOX, & WIDE DRAWERS LOCK

|                 |         |       |     |    |       |       |    |
|-----------------|---------|-------|-----|----|-------|-------|----|
| WRK-C2060BBWDLF | \$2,177 | \$532 | 255 | 25 | 59.25 | 19.75 | 29 |
| WRK-C2072BBWDLF | \$2,407 | \$544 | 275 | 30 | 71    | 19.75 | 29 |

24" DEEP W/ 1 ADJUSTABLE SHELF. HINGED CABINET DOORS, LATERAL FILE, LEFT BOX, & WIDE DRAWERS LOCK

|                 |         |       |     |    |       |       |    |
|-----------------|---------|-------|-----|----|-------|-------|----|
| WRK-C2460BBWDLF | \$2,244 | \$532 | 275 | 30 | 59.25 | 23.75 | 29 |
| WRK-C2472BBWDLF | \$2,471 | \$544 | 295 | 36 | 71    | 23.75 | 29 |

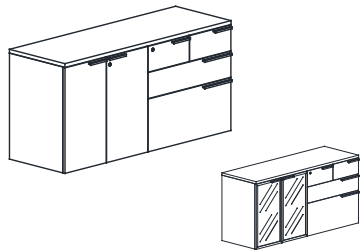

Optional AGD example:  
WRK-C2060BBWDLF-AGD-FR

**29" HIGH BOX/BOX/WIDE DRAWER/LATERAL FILE, CABINET CREDENZAS**

20" DEEP W/ 1 ADJUSTABLE SHELF. HINGED CABINET DOORS, LATERAL FILE, RIGHT BOX, & WIDE DRAWERS LOCK

|                 |         |       |     |    |       |       |    |
|-----------------|---------|-------|-----|----|-------|-------|----|
| WRK-BBWDLF2060C | \$2,177 | \$532 | 255 | 25 | 59.25 | 19.75 | 29 |
| WRK-BBWDLF2072C | \$2,407 | \$544 | 275 | 30 | 71    | 19.75 | 29 |

24" DEEP W/ 1 ADJUSTABLE SHELF. HINGED CABINET DOORS, LATERAL FILE, RIGHT BOX, & WIDE DRAWERS LOCK

|                 |         |       |     |    |       |       |    |
|-----------------|---------|-------|-----|----|-------|-------|----|
| WRK-BBWDLF2460C | \$2,244 | \$532 | 275 | 30 | 59.25 | 23.75 | 29 |
| WRK-BBWDLF2472C | \$2,471 | \$544 | 295 | 36 | 71    | 23.75 | 29 |

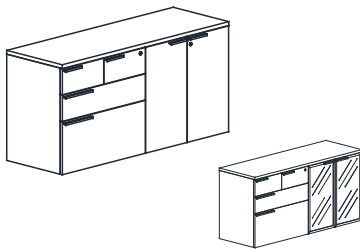

Optional AGD example:  
WRK-BBWDLF2060C-AGD-FR

**\*\* OPTIONAL ALUMINUM GLAZED DOORS \*\***

- SELECT CLEAR (CL), FROSTED (FR) OR BRONZE (BR) PLEXI GLASS
- SEE EXAMPLES ABOVE

- AGD DOORS INCLUDE SILVER FINISH BAR HANDLES.
- PLEASE REFER TO 100 SERIES (ACC) PAGE 100-3 FOR OTHER HANDLE CHOICES.
- \* THE PRICE SHOWN FOR AGD DOORS IS AN UP-CHARGE THAT MUST BE ADDED TO THE BASE PRICE OF THE UNIT IT GOES ON.

# WORKSCAPE CREDENZAS

## CREDENZAS- 27" HIGH

| MODEL | LIST | AGD        | WEIGHT | CUBE            | W  | D  | H  |
|-------|------|------------|--------|-----------------|----|----|----|
|       |      | *UP-CHARGE | LBS    | FT <sup>3</sup> | IN | IN | IN |

### 27" HIGH OPEN SHELF/CABINET CREDENZAS

20" DEEP W/ 1 ADJUSTABLE SHELF BOTH SIDES. CABINET DOORS LOCK.

|                |         |       |     |    |       |       |    |
|----------------|---------|-------|-----|----|-------|-------|----|
| WRK-CO2060C-27 | \$1,397 | \$532 | 193 | 24 | 59.25 | 19.75 | 27 |
| WRK-CO2072C-27 | \$1,555 | \$544 | 211 | 28 | 71    | 19.75 | 27 |

24" DEEP W/ 1 ADJUSTABLE SHELF BOTH SIDES. CABINET DOORS LOCK.

|                |         |       |     |    |       |       |    |
|----------------|---------|-------|-----|----|-------|-------|----|
| WRK-CO2460C-27 | \$1,463 | \$532 | 203 | 28 | 59.25 | 23.75 | 27 |
| WRK-CO2472C-27 | \$1,619 | \$544 | 228 | 34 | 71    | 23.75 | 27 |

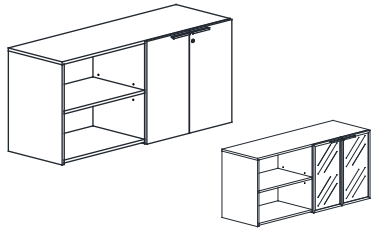

Optional AGD example:  
WRK-CO2060C-27-AGD-FR

### 27" HIGH CABINET/OPEN SHELF CREDENZAS

20" DEEP W/ 1 ADJUSTABLE SHELF BOTH SIDES. CABINET DOORS LOCK.

|                |         |       |     |    |       |       |    |
|----------------|---------|-------|-----|----|-------|-------|----|
| WRK-C2060CO-27 | \$1,397 | \$532 | 193 | 24 | 59.25 | 19.75 | 27 |
| WRK-C2072CO-27 | \$1,555 | \$544 | 211 | 28 | 71    | 19.75 | 27 |

24" DEEP W/ 1 ADJUSTABLE SHELF BOTH SIDES. CABINET DOORS LOCK.

|                |         |       |     |    |       |       |    |
|----------------|---------|-------|-----|----|-------|-------|----|
| WRK-C2460CO-27 | \$1,463 | \$532 | 203 | 28 | 59.25 | 23.75 | 27 |
| WRK-C2472CO-27 | \$1,619 | \$544 | 228 | 34 | 71    | 23.75 | 27 |

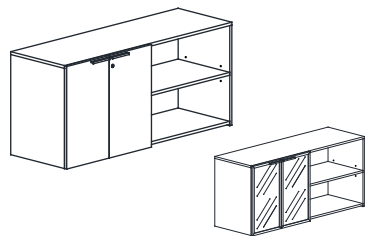

Optional AGD example:  
WRK-C2060CO-27-AGD-FR

#### \*\* OPTIONAL ALUMINUM GLAZED DOORS \*\*

- SELECT CLEAR (CL), FROSTED (FR) OR BRONZE (BR) PLEXI GLASS
- SEE EXAMPLES ABOVE

- AGD DOORS INCLUDE SILVER FINISH BAR HANDLES.
- PLEASE REFER TO 100 SERIES (ACC) PAGE [100-3](#) FOR OTHER HANDLE CHOICES.
- \* THE PRICE SHOWN FOR AGD DOORS IS AN UP-CHARGE THAT MUST BE ADDED TO THE BASE PRICE OF THE UNIT IT GOES ON.

### 27" HIGH OPEN SHELF/LATERAL FILE CREDENZAS

20" DEEP W/ 1 ADJUSTABLE SHELF. LATERAL FILE DRAWERS LOCK.

|                 |         |  |     |    |       |       |    |
|-----------------|---------|--|-----|----|-------|-------|----|
| WRK-CO2060LF-27 | \$1,697 |  | 208 | 24 | 59.25 | 19.75 | 27 |
| WRK-CO2072LF-27 | \$1,840 |  | 226 | 28 | 71    | 19.75 | 27 |

24" DEEP W/ 1 ADJUSTABLE SHELF. LATERAL FILE DRAWERS LOCK.

|                 |         |  |     |    |       |       |    |
|-----------------|---------|--|-----|----|-------|-------|----|
| WRK-CO2460LF-27 | \$1,761 |  | 218 | 28 | 59.25 | 23.75 | 27 |
| WRK-CO2472LF-27 | \$1,907 |  | 243 | 34 | 71    | 23.75 | 27 |

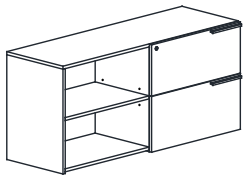

### 27" HIGH LATERAL FILE/OPEN SHELF CREDENZAS

20" DEEP W/ 1 ADJUSTABLE SHELF. LATERAL FILE DRAWERS LOCK.

|                 |         |  |     |    |       |       |    |
|-----------------|---------|--|-----|----|-------|-------|----|
| WRK-LF2060CO-27 | \$1,697 |  | 208 | 24 | 59.25 | 19.75 | 27 |
| WRK-LF2072CO-27 | \$1,840 |  | 226 | 28 | 71    | 19.75 | 27 |

24" DEEP W/ 1 ADJUSTABLE SHELF. LATERAL FILE DRAWERS LOCK.

|                 |         |  |     |    |       |       |    |
|-----------------|---------|--|-----|----|-------|-------|----|
| WRK-LF2460CO-27 | \$1,761 |  | 218 | 28 | 59.25 | 23.75 | 27 |
| WRK-LF2472CO-27 | \$1,907 |  | 243 | 34 | 71    | 23.75 | 27 |

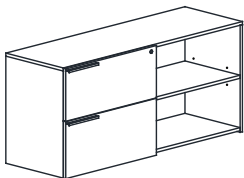

| MODEL | LIST | AGD        | WEIGHT | CUBE            | W  | D  | H  |
|-------|------|------------|--------|-----------------|----|----|----|
|       |      | *UP-CHARGE | LBS    | FT <sup>3</sup> | IN | IN | IN |

**27" HIGH OPEN SHELF, FILE/BOX/BOX/LATERAL FILE CREDENZAS**

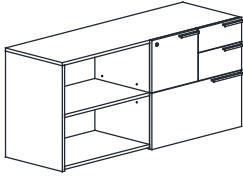

20" DEEP W/ 1 ADJUSTABLE SHELF. LATERAL FILE & FILE DRAWERS LOCK.

|                  |         |  |     |    |       |       |    |
|------------------|---------|--|-----|----|-------|-------|----|
| WRK-CO2060FUL-27 | \$1,963 |  | 218 | 24 | 59.25 | 19.75 | 27 |
| WRK-CO2072FUL-27 | \$2,119 |  | 241 | 28 | 71    | 19.75 | 27 |

24" DEEP W/ 1 ADJUSTABLE SHELF. LATERAL FILE & FILE DRAWERS LOCK.

|                  |         |  |     |    |       |       |    |
|------------------|---------|--|-----|----|-------|-------|----|
| WRK-CO2460FUL-27 | \$2,029 |  | 228 | 28 | 59.25 | 23.75 | 27 |
| WRK-CO2472FUL-27 | \$2,205 |  | 258 | 34 | 71    | 23.75 | 27 |

**27" HIGH BOX/BOX/FILE/LATERAL FILE, OPEN SHELF CREDENZAS**

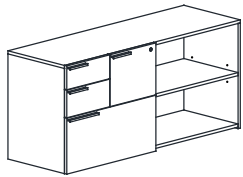

20" DEEP W/ 1 ADJUSTABLE SHELF. LATERAL FILE & FILE DRAWERS LOCK.

|                  |         |  |     |    |       |       |    |
|------------------|---------|--|-----|----|-------|-------|----|
| WRK-UFL2060CO-27 | \$1,963 |  | 218 | 24 | 59.25 | 19.75 | 27 |
| WRK-UFL2072CO-27 | \$2,119 |  | 241 | 28 | 71    | 19.75 | 27 |

24" DEEP W/ 1 ADJUSTABLE SHELF. LATERAL FILE & FILE DRAWERS LOCK.

|                  |         |  |     |    |       |       |    |
|------------------|---------|--|-----|----|-------|-------|----|
| WRK-UFL2460CO-27 | \$2,029 |  | 228 | 28 | 59.25 | 23.75 | 27 |
| WRK-UFL2472CO-27 | \$2,205 |  | 258 | 34 | 71    | 23.75 | 27 |

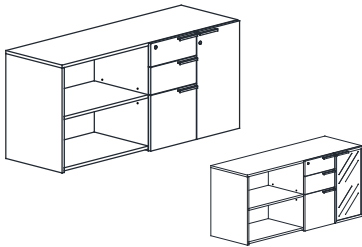

Optional AGD example:  
WRK-CO2060UFC-27-AGD-FR

**27" HIGH OPEN SHELF, BOX/BOX/FILE/CABINET CREDENZAS**

20" DEEP W/ 1 ADJUSTABLE SHELF BOTH SIDES. ALL DRAWERS & HINGED CABINET DOOR LOCKS.

|                  |         |       |     |    |       |       |    |
|------------------|---------|-------|-----|----|-------|-------|----|
| WRK-CO2060UFC-27 | \$1,834 | \$262 | 203 | 24 | 59.25 | 19.75 | 27 |
| WRK-CO2072UFC-27 | \$1,991 | \$276 | 221 | 28 | 71    | 19.75 | 27 |

24" DEEP W/ 1 ADJUSTABLE SHELF BOTH SIDES. ALL DRAWERS & HINGED CABINET DOOR LOCKS.

|                  |         |       |     |    |       |       |    |
|------------------|---------|-------|-----|----|-------|-------|----|
| WRK-CO2460UFC-27 | \$1,897 | \$262 | 213 | 28 | 59.25 | 23.75 | 27 |
| WRK-CO2472UFC-27 | \$2,074 | \$276 | 238 | 34 | 71    | 23.75 | 27 |

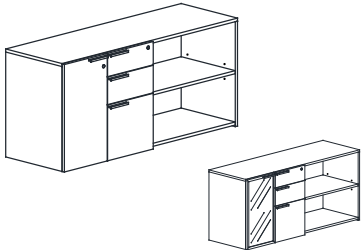

Optional AGD example:  
WRK-CUF2060CO-27-AGD-FR

**27" HIGH CABINET/BOX/BOX/FILE, OPEN SHELF CREDENZAS**

20" DEEP W/ 1 ADJUSTABLE SHELF BOTH SIDES. ALL DRAWERS & HINGED CABINET DOOR LOCKS.

|                  |         |       |     |     |       |       |    |
|------------------|---------|-------|-----|-----|-------|-------|----|
| WRK-CUF2060CO-27 | \$1,834 | \$262 | 203 | 24  | 59.25 | 19.75 | 27 |
| WRK-CUF2072CO-27 | \$1,991 | \$276 | 221 | 28/ | 71    | 19.75 | 27 |

24" DEEP W/ 1 ADJUSTABLE SHELF BOTH SIDES. ALL DRAWERS & HINGED CABINET DOOR LOCKS.

|                  |         |       |     |    |       |       |    |
|------------------|---------|-------|-----|----|-------|-------|----|
| WRK-CUF2460CO-27 | \$1,897 | \$262 | 213 | 28 | 59.25 | 23.75 | 27 |
| WRK-CUF2472CO-27 | \$2,074 | \$276 | 238 | 34 | 71    | 23.75 | 27 |

**\*\* OPTIONAL ALUMINUM GLAZED DOORS \*\***

- SELECT CLEAR (CL), FROSTED (FR) OR BRONZE (BR) PLEXI GLASS
- SEE EXAMPLES ABOVE

- AGD DOORS INCLUDE SILVER FINISH BAR HANDLES.
- PLEASE REFER TO 100 SERIES (ACC) PAGE 100-3 FOR OTHER HANDLE CHOICES.
- \* THE PRICE SHOWN FOR AGD DOORS IS AN UP-CHARGE THAT MUST BE ADDED TO THE BASE PRICE OF THE UNIT IT GOES ON.

# WORKSCAPE CREDENZAS

## 27" HIGH CREDENZAS

| MODEL | LIST | AGD        | WEIGHT | CUBE            | W  | D  | H  |
|-------|------|------------|--------|-----------------|----|----|----|
|       |      | *UP-CHARGE | LBS    | FT <sup>3</sup> | IN | IN | IN |

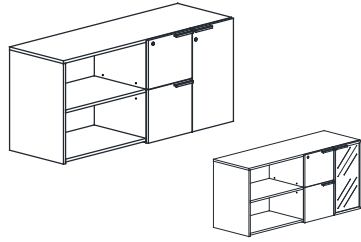

Optional AGD example:  
WRK-C2060FFC-27-AGD-FR

### 27" HIGH OPEN SHELF, FILE/FILE/CABINET CREDENZAS

20" DEEP W/ 1 ADJUSTABLE SHELF BOTH SIDES. FILE DRAWERS & HINGED CABINET DOOR LOCKS.

|                  |         |       |     |    |       |       |    |
|------------------|---------|-------|-----|----|-------|-------|----|
| WRK-CO2060FFC-27 | \$1,814 | \$262 | 203 | 24 | 59.25 | 19.75 | 27 |
| WRK-CO2072FFC-27 | \$1,971 | \$276 | 221 | 28 | 71    | 19.75 | 27 |

24" DEEP W/ 1 ADJUSTABLE SHELF BOTH SIDES. FILE DRAWERS & HINGED CABINET DOOR LOCKS.

|                  |         |       |     |    |       |       |    |
|------------------|---------|-------|-----|----|-------|-------|----|
| WRK-CO2460FFC-27 | \$1,879 | \$262 | 213 | 28 | 59.25 | 23.75 | 27 |
| WRK-CO2472FFC-27 | \$2,094 | \$276 | 238 | 34 | 71    | 23.75 | 27 |



Optional AGD example:  
WRK-CFF2060CO-27-AGD-FR

### 27" HIGH CABINET/FILE/ FILE, OPEN SHELF CREDENZAS

20" DEEP W/ 1 ADJUSTABLE SHELF BOTH SIDES. FILE DRAWERS & HINGED CABINET DOOR LOCKS.

|                  |         |       |     |    |       |       |    |
|------------------|---------|-------|-----|----|-------|-------|----|
| WRK-CFF2060CO-27 | \$1,814 | \$262 | 203 | 24 | 59.25 | 19.75 | 27 |
| WRK-CFF2072CO-27 | \$1,971 | \$276 | 221 | 28 | 71    | 19.75 | 27 |

24" DEEP W/ 1 ADJUSTABLE SHELF BOTH SIDES. FILE DRAWERS & HINGED CABINET DOOR LOCKS.

|                  |         |       |     |    |       |       |    |
|------------------|---------|-------|-----|----|-------|-------|----|
| WRK-CFF2460CO-27 | \$1,879 | \$262 | 213 | 28 | 59.25 | 23.75 | 27 |
| WRK-CFF2472CO-27 | \$2,094 | \$276 | 238 | 34 | 71    | 23.75 | 27 |

#### \*\* OPTIONAL ALUMINUM GLAZED DOORS \*\*

- SELECT CLEAR (CL), FROSTED (FR) OR BRONZE (BR) PLEXI GLASS
- SEE EXAMPLES ABOVE

- AGD DOORS INCLUDE SILVER FINISH BAR HANDLES.
- PLEASE REFER TO 100 SERIES (ACC) PAGE [100-3](#) FOR OTHER HANDLE CHOICES.
- \* THE PRICE SHOWN FOR AGD DOORS IS AN UP-CHARGE THAT MUST BE ADDED TO THE BASE PRICE OF THE UNIT IT GOES ON.

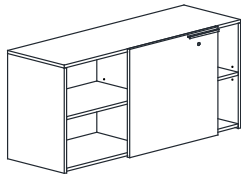

### 27" HIGH SLIDING DOOR CREDENZAS - RIGHT

20" DEEP W/ 1 ADJUSTABLE SHELF BOTH SIDES. SLIDING DOOR LOCKS RIGHT.

|                  |         |  |     |    |       |       |    |
|------------------|---------|--|-----|----|-------|-------|----|
| WRK-CO2060SDC-27 | \$1,463 |  | 193 | 24 | 59.25 | 19.75 | 27 |
| WRK-CO2072SDC-27 | \$1,627 |  | 211 | 28 | 71    | 19.75 | 27 |

24" DEEP W/ 1 ADJUSTABLE SHELF BOTH SIDES. SLIDING DOOR LOCKS RIGHT.

|                  |         |  |     |    |       |       |    |
|------------------|---------|--|-----|----|-------|-------|----|
| WRK-CO2460SDC-27 | \$1,529 |  | 203 | 28 | 59.25 | 23.75 | 27 |
| WRK-CO2472SDC-27 | \$1,691 |  | 228 | 34 | 71    | 23.75 | 27 |

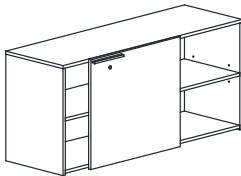

### 27" HIGH SLIDING DOOR CREDENZAS - LEFT

20" DEEP W/ 1 ADJUSTABLE SHELF BOTH SIDES. SLIDING DOOR LOCKS LEFT.

|                  |         |  |     |    |       |       |    |
|------------------|---------|--|-----|----|-------|-------|----|
| WRK-SDC2060CO-27 | \$1,463 |  | 193 | 24 | 59.25 | 19.75 | 27 |
| WRK-SDC2072CO-27 | \$1,627 |  | 211 | 28 | 71    | 19.75 | 27 |

24" DEEP W/ 1 ADJUSTABLE SHELF BOTH SIDES. SLIDING DOOR LOCKS LEFT.

|                  |         |  |     |    |       |       |    |
|------------------|---------|--|-----|----|-------|-------|----|
| WRK-SDC2460CO-27 | \$1,529 |  | 203 | 28 | 59.25 | 23.75 | 27 |
| WRK-SDC2472CO-27 | \$1,691 |  | 228 | 34 | 71    | 23.75 | 27 |

| MODEL | LIST | AGD        | WEIGHT | CUBE            | W  | D  | H  |
|-------|------|------------|--------|-----------------|----|----|----|
|       |      | *UP-CHARGE | LBS    | FT <sup>3</sup> | IN | IN | IN |

**21" HIGH OPEN SHELF, WIDE DRAWER/LATERAL FILE CREDENZAS**

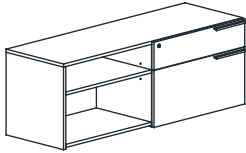

20" DEEP W/ 1 ADJUSTABLE SHELF. ALL DRAWERS LOCK.

|                   |         |  |     |    |       |       |    |
|-------------------|---------|--|-----|----|-------|-------|----|
| WRK-CO2060WDLF-21 | \$1,347 |  | 191 | 19 | 59.25 | 19.75 | 21 |
| WRK-CO2072WDLF-21 | \$1,472 |  | 207 | 23 | 71    | 19.75 | 21 |

24" DEEP W/ 1 ADJUSTABLE SHELF. ALL DRAWERS LOCK.

|                   |         |  |     |    |       |       |    |
|-------------------|---------|--|-----|----|-------|-------|----|
| WRK-CO2460WDLF-21 | \$1,399 |  | 199 | 23 | 59.25 | 23.75 | 21 |
| WRK-CO2472WDLF-21 | \$1,524 |  | 222 | 27 | 71    | 23.75 | 21 |

**21" HIGH WIDE DRAWER/LATERAL FILE, OPEN SHELF CREDENZA**

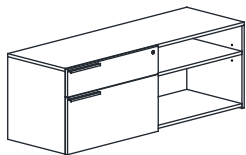

20" DEEP W/ 1 ADJUSTABLE SHELF. ALL DRAWERS LOCK.

|                   |         |  |     |    |       |       |    |
|-------------------|---------|--|-----|----|-------|-------|----|
| WRK-WDLF2060CO-21 | \$1,347 |  | 191 | 19 | 59.25 | 19.75 | 21 |
| WRK-WDLF2072CO-21 | \$1,472 |  | 207 | 23 | 71    | 19.75 | 21 |

24" DEEP W/ 1 ADJUSTABLE SHELF. ALL DRAWERS LOCK.

|                   |         |  |     |    |       |       |    |
|-------------------|---------|--|-----|----|-------|-------|----|
| WRK-WDLF2460CO-21 | \$1,399 |  | 199 | 23 | 59.25 | 23.75 | 21 |
| WRK-WDLF2472CO-21 | \$1,524 |  | 222 | 27 | 71    | 23.75 | 21 |

**21" HIGH OPEN SHELF, CABINET CREDENZAS**

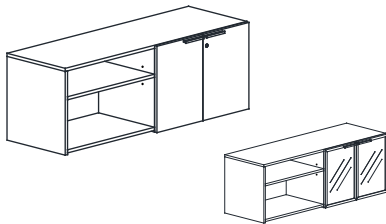

Optional AGD example:  
WRK-CO2060C-21-AGD-FR

20" DEEP W/ 1 ADJUSTABLE SHELF BOTH SIDES. HINGED CABINET DOORS LOCK

|                |         |       |     |    |       |       |    |
|----------------|---------|-------|-----|----|-------|-------|----|
| WRK-CO2060C-21 | \$1,253 | \$532 | 178 | 19 | 59.25 | 19.75 | 21 |
| WRK-CO2072C-21 | \$1,393 | \$544 | 195 | 23 | 71    | 19.75 | 21 |

24" DEEP W/ 1 ADJUSTABLE SHELF BOTH SIDES. HINGED CABINET DOORS LOCK

|                |         |       |     |    |       |       |    |
|----------------|---------|-------|-----|----|-------|-------|----|
| WRK-CO2460C-21 | \$1,310 | \$532 | 187 | 23 | 59.25 | 23.75 | 21 |
| WRK-CO2472C-21 | \$1,452 | \$544 | 210 | 27 | 71    | 23.75 | 21 |

**21" HIGH CABINET, OPEN SHELF CREDENZAS**

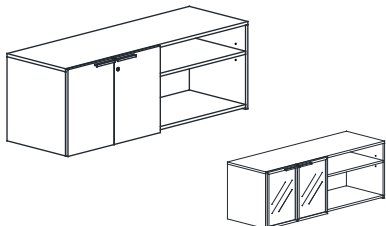

Optional AGD example:  
WRK-C2060CO-21-AGD-FR

20" DEEP W/ 1 ADJUSTABLE SHELF BOTH SIDES. HINGED CABINET DOORS LOCK

|                |         |       |     |    |       |       |    |
|----------------|---------|-------|-----|----|-------|-------|----|
| WRK-C2060CO-21 | \$1,253 | \$532 | 178 | 19 | 59.25 | 19.75 | 21 |
| WRK-C2072CO-21 | \$1,393 | \$544 | 195 | 23 | 71    | 19.75 | 21 |

24" DEEP W/ 1 ADJUSTABLE SHELF BOTH SIDES. HINGED CABINET DOORS LOCK

|                |         |       |     |    |       |       |    |
|----------------|---------|-------|-----|----|-------|-------|----|
| WRK-C2460CO-21 | \$1,310 | \$532 | 187 | 23 | 59.25 | 23.75 | 21 |
| WRK-C2472CO-21 | \$1,452 | \$544 | 210 | 27 | 71    | 23.75 | 21 |

**\*\* OPTIONAL ALUMINUM GLAZED DOORS \*\***

- SELECT CLEAR (CL), FROSTED (FR) OR BRONZE (BR) PLEXI GLASS
- SEE EXAMPLES ABOVE

- AGD DOORS INCLUDE SILVER FINISH BAR HANDLES.
- PLEASE REFER TO 100 SERIES (ACC) PAGE 100-3 FOR OTHER HANDLE CHOICES.
- \* THE PRICE SHOWN FOR AGD DOORS IS AN UP-CHARGE THAT MUST BE ADDED TO THE BASE PRICE OF THE UNIT IT GOES ON.

# WORKSCAPE CREDENZAS

## CREDENZAS- 21" HIGH

| MODEL | LIST | AGD        | WEIGHT | CUBE            | W  | D  | H  |
|-------|------|------------|--------|-----------------|----|----|----|
|       |      | *UP-CHARGE | LBS    | FT <sup>3</sup> | IN | IN | IN |

### 21" HIGH OPEN SHELF, BOX/BOX/LATERAL FILE CREDENZAS

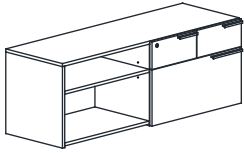

20" DEEP W/ 1 ADJUSTABLE SHELF. LEFT BOX & LATERAL FILE DRAWERS LOCK.

|                   |         |  |     |    |       |       |    |
|-------------------|---------|--|-----|----|-------|-------|----|
| WRK-CO2060BBLF-21 | \$1,717 |  | 196 | 19 | 59.25 | 19.75 | 21 |
| WRK-CO2072BBLF-21 | \$1,873 |  | 212 | 23 | 71    | 19.75 | 21 |

24" DEEP W/ 1 ADJUSTABLE SHELF. LEFT BOX & LATERAL FILE DRAWERS LOCK.

|                   |         |  |     |    |       |       |    |
|-------------------|---------|--|-----|----|-------|-------|----|
| WRK-CO2460BBLF-21 | \$1,782 |  | 204 | 23 | 59.25 | 23.75 | 21 |
| WRK-CO2472BBLF-21 | \$1,939 |  | 227 | 27 | 71    | 23.75 | 21 |

### 21" HIGH BOX/BOX/LATERAL FILE, OPEN SHELF CREDENZAS

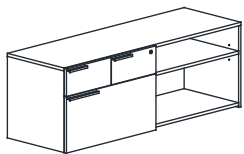

20" DEEP W/ 1 ADJUSTABLE SHELF. RIGHT BOX & LATERAL FILE DRAWERS LOCK.

|                   |         |  |     |    |       |       |    |
|-------------------|---------|--|-----|----|-------|-------|----|
| WRK-BBLF2060CO-21 | \$1,717 |  | 196 | 19 | 59.25 | 19.75 | 21 |
| WRK-BBLF2072CO-21 | \$1,873 |  | 212 | 23 | 71    | 19.75 | 21 |

24" DEEP W/ 1 ADJUSTABLE SHELF. RIGHT BOX & LATERAL FILE DRAWERS LOCK.

|                   |         |  |     |    |       |       |    |
|-------------------|---------|--|-----|----|-------|-------|----|
| WRK-BBLF2460CO-21 | \$1,782 |  | 204 | 23 | 59.25 | 23.75 | 21 |
| WRK-BBLF2472CO-21 | \$1,939 |  | 227 | 27 | 71    | 23.75 | 21 |

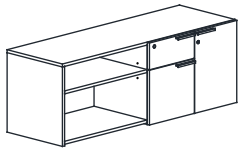

Optional AGD example:  
WRK-CO2060FC-21-AGD-FR

### 21" HIGH OPEN SHELF, BOX/ FILE/CABINET CREDENZAS

20" DEEP W/ 1 ADJUSTABLE SHELF BOTH SIDES. ALL DRAWERS & HINGED CABINET DOOR LOCK.

|                 |         |       |     |    |       |       |    |
|-----------------|---------|-------|-----|----|-------|-------|----|
| WRK-CO2060FC-21 | \$1,671 | \$262 | 187 | 19 | 59.25 | 19.75 | 21 |
| WRK-CO2072FC-21 | \$1,827 | \$276 | 203 | 23 | 71    | 19.75 | 21 |

24" DEEP W/ 1 ADJUSTABLE SHELF BOTH SIDES. ALL DRAWERS & HINGED CABINET DOOR LOCK.

|                 |         |       |     |    |       |       |    |
|-----------------|---------|-------|-----|----|-------|-------|----|
| WRK-CO2460FC-21 | \$1,735 | \$262 | 195 | 23 | 59.25 | 23.75 | 21 |
| WRK-CO2472FC-21 | \$1,892 | \$276 | 218 | 27 | 71    | 23.75 | 21 |

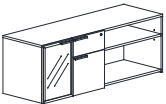
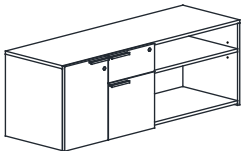

Optional AGD example:  
WRK-CF2060CO-21-AGD-FR

### 21" HIGH CABINET/BOX/FILE, OPEN SHELF CREDENZAS

20" DEEP W/ 1 ADJUSTABLE SHELF BOTH SIDES. ALL DRAWERS & HINGED CABINET DOOR LOCK.

|                 |         |       |     |    |       |       |    |
|-----------------|---------|-------|-----|----|-------|-------|----|
| WRK-CF2060CO-21 | \$1,671 | \$262 | 187 | 19 | 59.25 | 19.75 | 21 |
| WRK-CF2072CO-21 | \$1,827 | \$276 | 203 | 23 | 71    | 19.75 | 21 |

24" DEEP W/ 1 ADJUSTABLE SHELF BOTH SIDES. ALL DRAWERS & HINGED CABINET DOOR LOCK.

|                 |         |       |     |    |       |       |    |
|-----------------|---------|-------|-----|----|-------|-------|----|
| WRK-CF2460CO-21 | \$1,735 | \$262 | 195 | 23 | 59.25 | 23.75 | 21 |
| WRK-CF2472CO-21 | \$1,892 | \$276 | 218 | 27 | 71    | 23.75 | 21 |

#### \*\* OPTIONAL ALUMINUM GLAZED DOORS \*\*

- SELECT CLEAR (CL), FROSTED (FR) OR BRONZE (BR) PLEXI GLASS
- SEE EXAMPLES ABOVE

- AGD DOORS INCLUDE SILVER FINISH BAR HANDLES.
- PLEASE REFER TO 100 SERIES (ACC) PAGE [100-3](#) FOR OTHER HANDLE CHOICES.
- \* THE PRICE SHOWN FOR AGD DOORS IS AN UP-CHARGE THAT MUST BE ADDED TO THE BASE PRICE OF THE UNIT IT GOES ON.



| MODEL | LIST | AGD        | WEIGHT | CUBE            | W  | D  | H  |
|-------|------|------------|--------|-----------------|----|----|----|
|       |      | *UP-CHARGE | LBS    | FT <sup>3</sup> | IN | IN | IN |

**21" HIGH SLIDING DOOR CREDENZAS - HANDLES RIGHT**

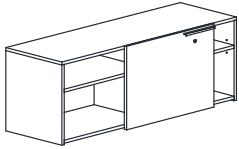

20" DEEP W/ 1 ADJUSTABLE SHELF BOTH SIDES. SLIDING DOOR LOCKS RIGHT.

|                  |         |  |     |    |       |       |    |
|------------------|---------|--|-----|----|-------|-------|----|
| WRK-CO2060SDC-21 | \$1,411 |  | 178 | 19 | 59.25 | 19.75 | 21 |
| WRK-CO2072SDC-21 | \$1,567 |  | 195 | 23 | 71    | 19.75 | 21 |

24" DEEP W/ 1 ADJUSTABLE SHELF BOTH SIDES. SLIDING DOOR LOCKS RIGHT.

|                  |         |  |     |    |       |       |    |
|------------------|---------|--|-----|----|-------|-------|----|
| WRK-CO2460SDC-21 | \$1,476 |  | 187 | 23 | 59.25 | 23.75 | 21 |
| WRK-CO2472SDC-21 | \$1,632 |  | 210 | 27 | 71    | 23.75 | 21 |

**21" HIGH SLIDING DOOR CREDENZAS - HANDLES LEFT**

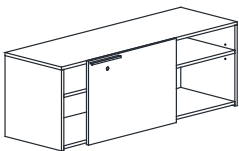

20" DEEP W/ 1 ADJUSTABLE SHELF BOTH SIDES. SLIDING DOOR LOCKS LEFT.

|                  |         |  |     |    |       |       |    |
|------------------|---------|--|-----|----|-------|-------|----|
| WRK-SDC2060CO-21 | \$1,411 |  | 178 | 19 | 59.25 | 19.75 | 21 |
| WRK-SDC2072CO-21 | \$1,567 |  | 195 | 23 | 71    | 19.75 | 21 |

24" DEEP W/ 1 ADJUSTABLE SHELF BOTH SIDES. SLIDING DOOR LOCKS LEFT.

|                  |         |  |     |    |       |       |    |
|------------------|---------|--|-----|----|-------|-------|----|
| WRK-SDC2460CO-21 | \$1,476 |  | 187 | 23 | 59.25 | 23.75 | 21 |
| WRK-SDC2472CO-21 | \$1,632 |  | 210 | 27 | 71    | 23.75 | 21 |

# WORKSCAPE HUTCHES

## OPEN WORK SURFACE END HUTCHES W/ METAL SUPPORTS

| MODEL | LIST | AGD        | WEIGHT | CUBE            | W  | D  | H  |
|-------|------|------------|--------|-----------------|----|----|----|
|       |      | *UP-CHARGE | LBS    | FT <sup>3</sup> | IN | IN | IN |

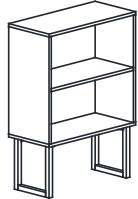
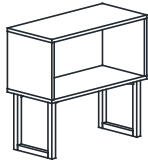

RTA

### OPEN WORK SURFACE END HUTCHES W/ METAL SUPPORTS

28" HIGH. 13" CLEARANCE TO BOTTOM OF FIXED SHELF.

|              |       |  |    |   |       |    |       |
|--------------|-------|--|----|---|-------|----|-------|
| WRK-2824WEMH | \$488 |  | 35 | 1 | 23.75 | 14 | 27.75 |
| WRK-2830WEMH | \$533 |  | 40 | 1 | 29.5  | 14 | 27.75 |
| WRK-2836WEMH | \$579 |  | 45 | 2 | 35.5  | 14 | 27.75 |

42" HIGH W/ 1 FIXED SHELF. 13" CLEARANCE TO BOTTOM OF FIXED SHELF.

|              |       |  |    |   |       |    |      |
|--------------|-------|--|----|---|-------|----|------|
| WRK-4224WEMH | \$748 |  | 67 | 1 | 23.75 | 14 | 41.5 |
| WRK-4230WEMH | \$794 |  | 77 | 1 | 29.5  | 14 | 41.5 |
| WRK-4236WEMH | \$838 |  | 87 | 2 | 35.5  | 14 | 41.5 |

**AVAILABLE FINISH:** METAL SUPPORTS IN SILVER (SL), WHITE (WH) OR BLACK (BL) POWDER COAT.

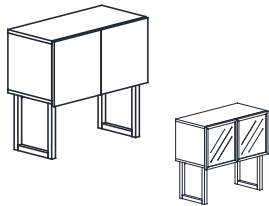

Optional AGD example:  
WRK-2830WEMHHD-AGD-FR

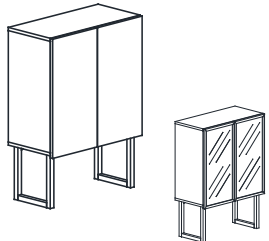

Optional AGD example:  
WRK-4230WEMHHD-AGD-FR

RTA

### WORK SURFACE END HUTCHES W/ HINGED DOORS & METAL SUPPORTS

28" HIGH. 12½" CLEARANCE TO BOTTOM OF DOORS.

|                |       |       |    |   |       |       |       |
|----------------|-------|-------|----|---|-------|-------|-------|
| WRK-2824WEMHHD | \$716 | \$387 | 41 | 1 | 23.75 | 14.75 | 27.75 |
| WRK-2830WEMHHD | \$760 | \$400 | 48 | 1 | 29.5  | 14.75 | 27.75 |
| WRK-2836WEMHHD | \$806 | \$444 | 55 | 2 | 35.5  | 14.75 | 27.75 |

42" HIGH W/ 1 FIXED SHELF. 12½" CLEARANCE TO BOTTOM OF DOORS.

|                |         |       |     |   |       |       |      |
|----------------|---------|-------|-----|---|-------|-------|------|
| WRK-4224WEMHHD | \$975   | \$551 | 86  | 1 | 23.75 | 14.75 | 41.5 |
| WRK-4230WEMHHD | \$1,021 | \$562 | 101 | 1 | 29.5  | 14.75 | 41.5 |
| WRK-4236WEMHHD | \$1,065 | \$643 | 116 | 2 | 35.5  | 14.75 | 41.5 |

**AVAILABLE FINISH:** METAL SUPPORTS IN SILVER (SL), WHITE (WH) OR BLACK (BL) POWDER COAT.

- TO LOCK HUTCH DOORS, **ADD AN "L" TO ITEM #** & ADD **\$76** TO RETAIL PRICE.  
**Example:** WRK-2836WEMHHD-L
- HUTCH DOORS DO NOT REQUIRE HANDLES. TO ADD HANDLES PLEASE REFER TO PAGE [100-3](#)

#### \*\* OPTIONAL ALUMINUM GLAZED DOORS \*\*

- SELECT CLEAR (CL), FROSTED (FR) OR BRONZE (BR) PLEXI GLASS.
- \* THE PRICE SHOWN FOR AGD DOORS IS AN UP-CHARGE THAT MUST BE ADDED TO THE BASE PRICE OF THE UNIT IT GOES ON.

## OPEN WORK SURFACE END HUTCHES W/ LAMINATE GABLES

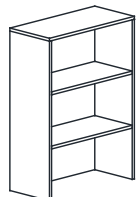
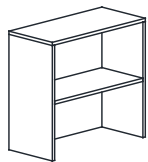

RTA

### OPEN WORK SURFACE END HUTCHES

28" HIGH W/ 1 FIXED SHELF. 13" CLEARANCE TO BOTTOM OF FIXED SHELF.

|             |       |  |    |   |       |    |       |
|-------------|-------|--|----|---|-------|----|-------|
| WRK-2824WEH | \$514 |  | 39 | 1 | 23.75 | 14 | 27.75 |
| WRK-2830WEH | \$559 |  | 44 | 1 | 29.5  | 14 | 27.75 |
| WRK-2836WEH | \$605 |  | 50 | 2 | 35.5  | 14 | 27.75 |

42" HIGH W/ 2 FIXED SHELF. 13" CLEARANCE TO BOTTOM OF FIXED SHELF.

|             |       |  |    |   |       |    |      |
|-------------|-------|--|----|---|-------|----|------|
| WRK-4224WEH | \$619 |  | 71 | 1 | 23.75 | 14 | 41.5 |
| WRK-4230WEH | \$656 |  | 82 | 1 | 29.5  | 14 | 41.5 |
| WRK-4236WEH | \$692 |  | 92 | 2 | 35.5  | 14 | 41.5 |

| MODEL | LIST | AGD        | WEIGHT | CUBE            | W  | D  | H  |
|-------|------|------------|--------|-----------------|----|----|----|
|       |      | *UP-CHARGE | LBS    | FT <sup>3</sup> | IN | IN | IN |

**WORK SURFACE END HUTCHES W/ HINGED DOORS**

28" HIGH W/ 1 FIXED SHELF. 12½" CLEARANCE TO BOTTOM OF DOORS.

|               |       |       |    |   |       |       |       |
|---------------|-------|-------|----|---|-------|-------|-------|
| WRK-2824WEHHD | \$742 | \$387 | 45 | 1 | 23.75 | 14.75 | 27.75 |
| WRK-2830WEHHD | \$785 | \$400 | 53 | 1 | 29.5  | 14.75 | 27.75 |
| WRK-2836WEHHD | \$833 | \$444 | 60 | 2 | 35.5  | 14.75 | 27.75 |

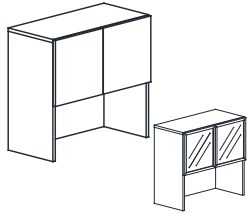

Optional AGD example:  
WRK-2830WEHHD-AGD-FR

42" HIGH W/ 2 FIXED SHELF. 12½" CLEARANCE TO BOTTOM OF DOORS.

|               |         |       |     |   |       |       |      |
|---------------|---------|-------|-----|---|-------|-------|------|
| WRK-4224WEHHD | \$1,002 | \$551 | 90  | 1 | 23.75 | 14.75 | 41.5 |
| WRK-4230WEHHD | \$1,047 | \$562 | 105 | 1 | 29.5  | 14.75 | 41.5 |
| WRK-4236WEHHD | \$1,093 | \$643 | 121 | 2 | 35.5  | 14.75 | 41.5 |

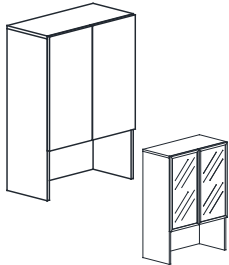

Optional AGD example:  
WRK-4230WEHHD-AGD-FR

- TO LOCK HUTCH DOORS, **ADD AN "L" TO ITEM #** & ADD **\$76** TO RETAIL PRICE.  
**Example:** WRK-4236WEHHD-L
- HUTCH DOORS DO NOT REQUIRE HANDLES. TO ADD HANDLES PLEASE REFER TO 100 SERIES (ACC) PAGE **100-3**

**\*\* OPTIONAL ALUMINUM GLAZED DOORS \*\***

- SELECT CLEAR (CL), FROSTED (FR) OR BRONZE (BR) PLEXI GLASS.
- \* THE PRICE SHOWN FOR AGD DOORS IS AN UP-CHARGE THAT MUST BE ADDED TO THE BASE PRICE OF THE UNIT IT GOES ON.

**RTA**

**HUTCHES W/ METAL SUPPORTS & PLEXI BI-PASS DOORS**

**HUTCHES W/ METAL SUPPORTS**

**OPEN HUTCHES W/ METAL SUPPORTS**

28" HIGH. OPEN CENTER SECTION ON 72" HUTCH. 13" CLEARANCE TO BOTTOM OF FIXED SHELF.

|            |       |  |    |   |       |    |       |
|------------|-------|--|----|---|-------|----|-------|
| WRK-2860MH | \$716 |  | 67 | 3 | 59.25 | 14 | 27.75 |
| WRK-2872MH | \$884 |  | 76 | 3 | 71    | 14 | 27.75 |

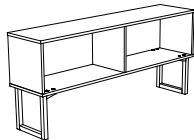

WRK-2860MH

30" HIGH. OPEN CENTER SECTION ON 72" HUTCH. 15" CLEARANCE TO BOTTOM OF FIXED SHELF.

|            |       |  |    |   |       |    |       |
|------------|-------|--|----|---|-------|----|-------|
| WRK-3060MH | \$742 |  | 67 | 3 | 59.25 | 14 | 29.75 |
| WRK-3072MH | \$911 |  | 76 | 3 | 71    | 14 | 29.75 |

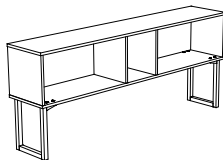

WRK-3072MH

36" HIGH. OPEN CENTER SECTION ON 72" HUTCH. 21" CLEARANCE TO BOTTOM OF FIXED SHELF.

|            |       |  |    |   |       |    |      |
|------------|-------|--|----|---|-------|----|------|
| WRK-3660MH | \$769 |  | 72 | 3 | 59.25 | 14 | 35.5 |
| WRK-3672MH | \$937 |  | 79 | 3 | 71    | 14 | 35.5 |

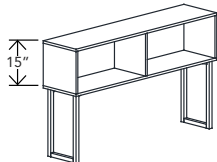

WRK-3660MH

**AVAILABLE FINISH:** METAL SUPPORTS IN SILVER (SL), WHITE (WH) OR BLACK (BL) POWDER COAT.

- TO ADD A SET OF 4 PLEXI COLLATOR SHELVES, **ADD '-COL' TO ITEM #** & ADD **\$369** TO RETAIL PRICE 72" HUTCHES ONLY

**Example:** WRK-2872MH-COL

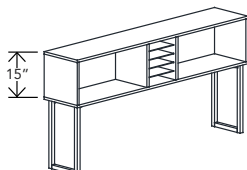

Optional COLLATOR SHELVES example:  
WRK-3672MH-COL

**RTA**

# WORKSCAPE HUTCHES

## HUTCHES W/ METAL SUPPORTS

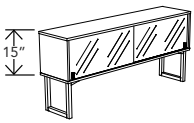

WRK-2860MHBD

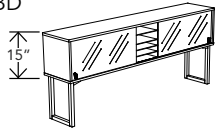

Optional COLLATOR SHELVES  
example:

WRK-3072MHBD-COL

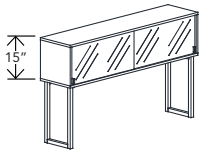

WRK-3660MHBD

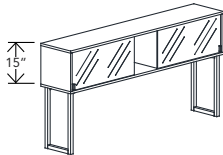

WRK-3672MHBD

RTA

| MODEL | LIST | AGD        | WEIGHT | CUBE            | W  | D  | H  |
|-------|------|------------|--------|-----------------|----|----|----|
|       |      | *UP-CHARGE | LBS    | FT <sup>3</sup> | IN | IN | IN |

28" HIGH. DOORS HAVE HANDLES. OPEN CENTER SECTION ON 72" HUTCH. 13" CLEARANCE TO BOTTOM OF FIXED SHELF.

|              |         |  |    |   |       |    |       |
|--------------|---------|--|----|---|-------|----|-------|
| WRK-2860MHBD | \$1,534 |  | 71 | 3 | 59.25 | 14 | 27.75 |
| WRK-2872MHBD | \$1,795 |  | 80 | 3 | 71    | 14 | 27.75 |

30" HIGH. DOORS HAVE HANDLES. OPEN CENTER SECTION ON 72" HUTCH. 15" CLEARANCE TO BOTTOM OF FIXED SHELF.

|              |         |  |    |   |       |    |      |
|--------------|---------|--|----|---|-------|----|------|
| WRK-3060MHBD | \$1,560 |  | 71 | 3 | 59.25 | 14 | 29.5 |
| WRK-3072MHBD | \$1,821 |  | 80 | 3 | 71    | 14 | 29.5 |

36" HIGH. DOORS HAVE HANDLES. OPEN CENTER SECTION ON 72" HUTCH. 21" CLEARANCE TO BOTTOM OF FIXED SHELF.

|              |         |  |    |   |       |    |      |
|--------------|---------|--|----|---|-------|----|------|
| WRK-3660MHBD | \$1,664 |  | 71 | 3 | 59.25 | 14 | 35.5 |
| WRK-3672MHBD | \$1,924 |  | 80 | 3 | 71    | 14 | 35.5 |

**AVAILABLE FINISH:** METAL SUPPORTS IN SILVER (SL), WHITE (WH) OR BLACK (BL) POWDER COAT.

- TO ADD A SET OF 4 PLEXI COLLATOR SHELVES, ADD '-COL' TO ITEM # & ADD \$369 TO RETAIL PRICE 72" HUTCHES ONLY

**Example:** WRK-2872MHBD-COL

### HUTCHES W/ METAL SUPPORTS & HINGED DOORS

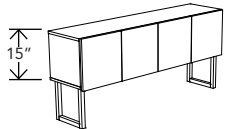

WRK-2860MHHD

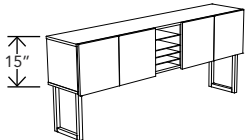

Optional COLLATOR SHELVES example:

WRK-3072MHHD-COL

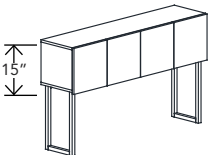

WRK-3660MHHD

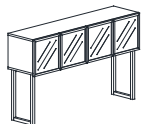

Optional AGD example:  
WRK-3660MHHD-AGD-FR

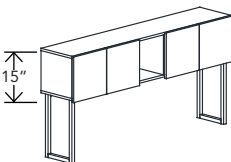

WRK-3672MHHD

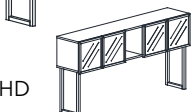

Optional AGD example:  
WRK-3672MHHD-AGD-FR

RTA

28" HIGH. OPEN CENTER SECTION ON 72" HUTCH. 12½" CLEARANCE TO BOTTOM OF FIXED SHELF DOORS.

|              |         |       |    |   |       |       |       |
|--------------|---------|-------|----|---|-------|-------|-------|
| WRK-2860MHHD | \$1,223 | \$834 | 83 | 3 | 59.25 | 14.75 | 27.75 |
| WRK-2872MHHD | \$1,473 | \$834 | 92 | 3 | 71    | 14.75 | 27.75 |

30" HIGH. OPEN CENTER SECTION ON 72" HUTCH. 14½" CLEARANCE TO BOTTOM OF FIXED SHELF DOORS.

|              |         |       |    |   |       |       |      |
|--------------|---------|-------|----|---|-------|-------|------|
| WRK-3060MHHD | \$1,253 | \$834 | 83 | 3 | 59.25 | 14.75 | 29.5 |
| WRK-3072MHHD | \$1,501 | \$834 | 92 | 3 | 71    | 14.75 | 29.5 |

36" HIGH. OPEN CENTER SECTION ON 72" HUTCH. 20½" CLEARANCE TO BOTTOM OF DOORS.

|              |         |       |    |   |       |       |      |
|--------------|---------|-------|----|---|-------|-------|------|
| WRK-3660MHHD | \$1,280 | \$834 | 83 | 3 | 59.25 | 14.75 | 35.5 |
| WRK-3672MHHD | \$1,531 | \$834 | 92 | 3 | 71    | 14.75 | 35.5 |

**AVAILABLE FINISH:** METAL SUPPORTS IN SILVER (SL), WHITE (WH) OR BLACK (BL) POWDER COAT.

- TO LOCK HUTCH DOORS, ADD AN "L" TO ITEM # & ADD \$76 TO RETAIL PRICE.  
**Example:** WRK-2872MHHD-L
- TO ADD A SET OF 4 PLEXI COLLATOR SHELVES, ADD '-COL' TO ITEM # & ADD \$369 TO RETAIL PRICE 72" HUTCHES ONLY  
**Example:** WRK-2872MHHD-COL
- HUTCH DOORS DO NOT REQUIRE HANDLES. TO ADD HANDLES PLEASE REFER TO 100 SERIES (ACC) PAGE [100-3](#)

#### \*\* OPTIONAL ALUMINUM GLAZED DOORS \*\*

- SELECT CLEAR (CL), FROSTED (FR) OR BRONZE (BR) PLEXI GLASS.
- \* THE PRICE SHOWN FOR AGD DOORS IS AN UP-CHARGE THAT MUST BE ADDED TO THE BASE PRICE OF THE UNIT IT GOES ON.

| MODEL | LIST | AGD        | WEIGHT | CUBE            | W  | D  | H  |
|-------|------|------------|--------|-----------------|----|----|----|
|       |      | *UP-CHARGE | LBS    | FT <sup>3</sup> | IN | IN | IN |

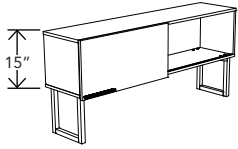

WRK-2860MHSD-L

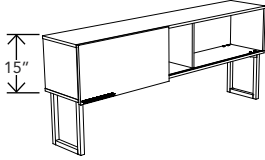

WRK-3072MHSD-L

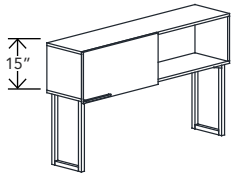

WRK-3660MHSD-L

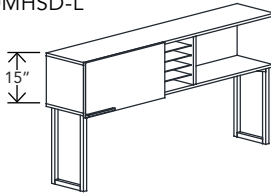

Optional COLLATOR SHELVES example:  
WRK-3672MHSD-L-COL

**RTA**

**HUTCHES W/ METAL SUPPORTS & SLIDING DOOR - HANDLE LEFT**

28" HIGH. DOOR HAS HANDLE. OPEN CENTER SECTION ON 72" HUTCH. 12½" CLEARANCE TO BOTTOM OF FIXED SHELF DOORS.

|                |         |  |    |   |       |       |       |
|----------------|---------|--|----|---|-------|-------|-------|
| WRK-2860MHSD-L | \$1,211 |  | 75 | 3 | 59.25 | 14.75 | 27.75 |
| WRK-2872MHSD-L | \$1,460 |  | 84 | 3 | 71    | 14.75 | 27.75 |

30" HIGH. DOOR HAS HANDLE. OPEN CENTER SECTION ON 72" HUTCH. 14½" CLEARANCE TO BOTTOM OF FIXED SHELF DOORS.

|                |         |  |    |   |       |       |      |
|----------------|---------|--|----|---|-------|-------|------|
| WRK-3060MHSD-L | \$1,238 |  | 75 | 3 | 59.25 | 14.75 | 29.5 |
| WRK-3072MHSD-L | \$1,489 |  | 84 | 3 | 71    | 14.75 | 29.5 |

36" HIGH. DOOR HAS HANDLE. OPEN CENTER SECTION ON 72" HUTCH. 20½" CLEARANCE TO BOTTOM OF FIXED SHELF.

|                |         |  |    |   |       |       |      |
|----------------|---------|--|----|---|-------|-------|------|
| WRK-3660MHSD-L | \$1,268 |  | 75 | 3 | 59.25 | 14.75 | 35.5 |
| WRK-3672MHSD-L | \$1,517 |  | 84 | 3 | 71    | 14.75 | 35.5 |

**AVAILABLE FINISH:** METAL SUPPORTS IN SILVER (SL), WHITE (WH) OR BLACK (BL) POWDER COAT.

- TO ADD A SET OF 4 PLEXI COLLATOR SHELVES, **ADD '-COL'** TO ITEM # & ADD **\$369** TO RETAIL PRICE 72" HUTCHES ONLY  
**example: WRK-3672MHSD-L-COL**

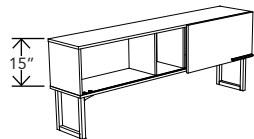

WRK-2872MHSD-R

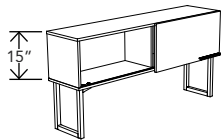

WRK-3060MHSD-R

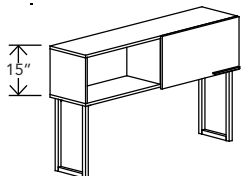

WRK-3660MHSD-R

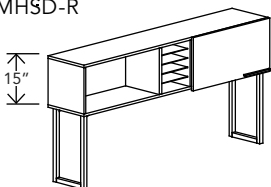

Optional COLLATOR SHELVES example:  
WRK-3672MHSD-R-COL

**RTA**

**HUTCHES W/ METAL SUPPORTS & SLIDING DOOR - HANDLE RIGHT**

28" HIGH. DOOR HAS HANDLE. OPEN CENTER SECTION ON 72" HUTCH. 12½" CLEARANCE TO BOTTOM OF FIXED SHELF DOORS.

|                |         |  |    |   |       |       |       |
|----------------|---------|--|----|---|-------|-------|-------|
| WRK-2860MHSD-R | \$1,211 |  | 75 | 3 | 59.25 | 14.75 | 27.75 |
| WRK-2872MHSD-R | \$1,460 |  | 84 | 3 | 71    | 14.75 | 27.75 |

30" HIGH. DOOR HAS HANDLE. OPEN CENTER SECTION ON 72" HUTCH. 14½" CLEARANCE TO BOTTOM OF FIXED SHELF DOORS.

|                |         |  |    |   |       |       |      |
|----------------|---------|--|----|---|-------|-------|------|
| WRK-3060MHSD-R | \$1,238 |  | 75 | 3 | 59.25 | 14.75 | 29.5 |
| WRK-3072MHSD-R | \$1,489 |  | 84 | 3 | 71    | 14.75 | 29.5 |

36" HIGH. DOOR HAS HANDLE. OPEN CENTER SECTION ON 72" HUTCH. 20½" CLEARANCE TO BOTTOM OF FIXED SHELF.

|                |         |  |    |   |       |       |      |
|----------------|---------|--|----|---|-------|-------|------|
| WRK-3660MHSD-R | \$1,268 |  | 75 | 3 | 59.25 | 14.75 | 35.5 |
| WRK-3672MHSD-R | \$1,517 |  | 84 | 3 | 71    | 14.75 | 35.5 |

**AVAILABLE FINISH:** METAL SUPPORTS IN SILVER (SL), WHITE (WH) OR BLACK (BL) POWDER COAT.

- TO ADD A SET OF 4 PLEXI COLLATOR SHELVES, **ADD '-COL'** TO ITEM # & ADD **\$369** TO RETAIL PRICE 72" HUTCHES ONLY  
**EXAMPLE: WRK-3672MHSD-R-COL**

| MODEL | LIST | AGD        | WEIGHT | CUBE            | W  | D  | H  |
|-------|------|------------|--------|-----------------|----|----|----|
|       |      | *UP-CHARGE | LBS    | FT <sup>3</sup> | IN | IN | IN |

**OPEN HUTCHES W/ LAMINATE GABLES**

28" HIGH. OPEN CENTER SECTION ON 72" HUTCH. 13" CLEARANCE TO BOTTOM OF FIXED SHELF.

|           |              |  |    |   |       |    |       |
|-----------|--------------|--|----|---|-------|----|-------|
| WRK-2860H | <b>\$742</b> |  | 74 | 3 | 59.25 | 14 | 27.75 |
| WRK-2872H | <b>\$931</b> |  | 83 | 4 | 71    | 14 | 27.75 |

42" HIGH. OPEN CENTER SECTION ON 72" HUTCH. 26¾" CLEARANCE TO BOTTOM OF FIXED SHELF.

|           |                |  |    |   |       |    |      |
|-----------|----------------|--|----|---|-------|----|------|
| WRK-4260H | <b>\$879</b>   |  | 82 | 3 | 59.25 | 14 | 41.5 |
| WRK-4272H | <b>\$1,035</b> |  | 91 | 4 | 71    | 14 | 41.5 |

- TO ADD A SET OF 4 PLEXI COLLATOR SHELVES, **ADD '-COL' TO ITEM #** & ADD **\$369** TO RETAIL PRICE 72" HUTCHES ONLY

**Example:** WRK-4272H-COL

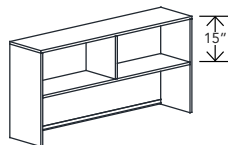

WRK-2860H

**RTA**

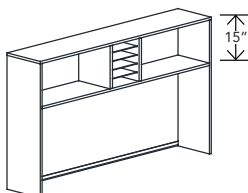

Optional COLLATOR SHELVES example:

WRK-4272H-COL

**HUTCHES W/ LAMINATE GABLES & PLEXI BI-PASS DOORS**

28" HIGH. DOORS HAVE HANDLES. OPEN CENTER SECTION ON 72" HUTCH. 13" CLEARANCE TO BOTTOM OF FIXED SHELF.

|             |                |  |    |   |       |    |       |
|-------------|----------------|--|----|---|-------|----|-------|
| WRK-2860HBD | <b>\$1,600</b> |  | 77 | 3 | 59.25 | 14 | 27.75 |
| WRK-2872HBD | <b>\$1,912</b> |  | 87 | 4 | 71    | 14 | 27.75 |

42" HIGH. DOORS HAVE HANDLES. OPEN CENTER SECTION ON 72" HUTCH. 26¾" CLEARANCE TO BOTTOM OF FIXED SHELF.

|             |                |  |    |   |       |    |      |
|-------------|----------------|--|----|---|-------|----|------|
| WRK-4260HBD | <b>\$1,750</b> |  | 86 | 3 | 59.25 | 14 | 41.5 |
| WRK-4272HBD | <b>\$2,042</b> |  | 95 | 4 | 71    | 14 | 41.5 |

- TO ADD A SET OF 4 PLEXI COLLATOR SHELVES, **ADD '-COL' TO ITEM #** & ADD **\$369** TO RETAIL PRICE 72" HUTCHES ONLY

**Example:** WRK-4272HBD-COL

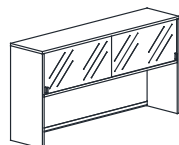

WRK-2860HBD

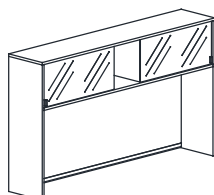

WRK-4272HBD

**RTA**

**HUTCHES W/ LAMINATE GABLES & HINGED DOORS**

28" HIGH. HINGED DOORS. OPEN CENTER SECTION ON 72" HUTCH. 12½" CLEARANCE TO BOTTOM OF DOORS.

|             |                |              |    |   |       |       |       |
|-------------|----------------|--------------|----|---|-------|-------|-------|
| WRK-2860HHD | <b>\$1,144</b> | <b>\$834</b> | 90 | 4 | 59.25 | 14.75 | 27.75 |
| WRK-2872HHD | <b>\$1,456</b> | <b>\$834</b> | 99 | 4 | 71    | 14.75 | 27.75 |

42" HIGH. HINGED DOORS. OPEN CENTER SECTION ON 72" HUTCH. 26¼" CLEARANCE TO BOTTOM OF DOORS.

|             |                |              |     |   |       |       |      |
|-------------|----------------|--------------|-----|---|-------|-------|------|
| WRK-4260HHD | <b>\$1,165</b> | <b>\$834</b> | 98  | 4 | 59.25 | 14.75 | 41.5 |
| WRK-4272HHD | <b>\$1,549</b> | <b>\$834</b> | 107 | 4 | 71    | 14.75 | 41.5 |

- TO LOCK HUTCH DOORS, **ADD AN "L" TO ITEM #** & ADD **\$76** TO RETAIL PRICE.

**Example:** WRK-2872MHHD-L

- TO ADD A SET OF 4 PLEXI COLLATOR SHELVES, **ADD '-COL' TO ITEM #** & ADD **\$369** TO RETAIL PRICE, 72" HUTCHES ONLY

**Example:** WRK-4272HHD-COL

- HUTCH DOORS DO NOT REQUIRE HANDLES. TO ADD HANDLES PLEASE REFER TO 100 SERIES (ACC) PAGE **100-3**

**\*\* OPTIONAL ALUMINUM GLAZED DOORS \*\***

- SELECT CLEAR (CL), FROSTED (FR) OR BRONZE (BR) PLEXI GLASS

- \* THE PRICE SHOWN FOR AGD DOORS IS AN UP-CHARGE THAT MUST BE ADDED TO THE BASE PRICE OF THE UNIT IT GOES ON.

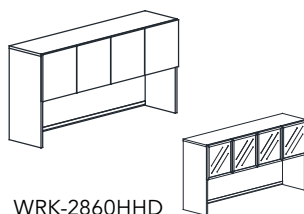

WRK-2860HHD

Optional AGD example:  
 WRK-2860HHD-AGD-FR

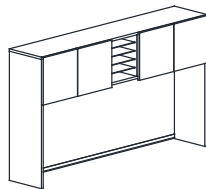

Optional COLLATOR SHELVES example:

WRK-4272HHD-COL

**RTA**

| MODEL | LIST | AGD        | WEIGHT | CUBE            | W  | D  | H  |
|-------|------|------------|--------|-----------------|----|----|----|
|       |      | *UP-CHARGE | LBS    | FT <sup>3</sup> | IN | IN | IN |

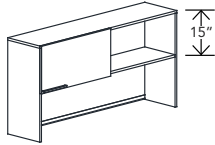

WRK-2860HSD-L

**HUTCHES W/ LAMINATE GABLES & SLIDING DOOR - HANDLE LEFT**

28" HIGH. DOOR HAS HANDLE. OPEN CENTER SECTION ON 72" HUTCH. 12½" CLEARANCE TO BOTTOM OF DOOR.

|               |         |  |    |   |       |       |       |
|---------------|---------|--|----|---|-------|-------|-------|
| WRK-2860HSD-L | \$1,132 |  | 82 | 4 | 59.25 | 14.75 | 27.75 |
| WRK-2872HSD-L | \$1,443 |  | 91 | 4 | 71    | 14.75 | 27.75 |

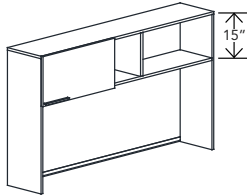

WRK-4272HSD-L

42" HIGH. DOOR HAS HANDLE. OPEN CENTER SECTION ON 72" HUTCH. 26¼" CLEARANCE TO BOTTOM OF DOOR.

|               |         |  |    |   |       |       |      |
|---------------|---------|--|----|---|-------|-------|------|
| WRK-4260HSD-L | \$1,152 |  | 90 | 4 | 59.25 | 14.75 | 41.5 |
| WRK-4272HSD-L | \$1,534 |  | 99 | 4 | 71    | 14.75 | 41.5 |

- TO ADD A SET OF 4 PLEXI COLLATOR SHELVES, **ADD '-COL' TO ITEM #** & ADD **\$369** TO RETAIL PRICE 72" HUTCHES ONLY  
**Example:** WRK-4272HSD-L-COL

**RTA**

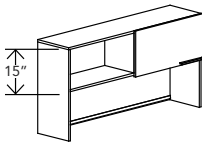

WRK-2860HSD-R

**HUTCHES W/ LAMINATE GABLES & SLIDING DOOR - HANDLE RIGHT**

28" HIGH. DOOR HAS HANDLE. OPEN CENTER SECTION ON 72" HUTCH. 12½" CLEARANCE TO BOTTOM OF DOOR.

|               |         |  |    |   |       |       |       |
|---------------|---------|--|----|---|-------|-------|-------|
| WRK-2860HSD-R | \$1,132 |  | 82 | 4 | 59.25 | 14.75 | 27.75 |
| WRK-2872HSD-R | \$1,443 |  | 91 | 4 | 71    | 14.75 | 27.75 |

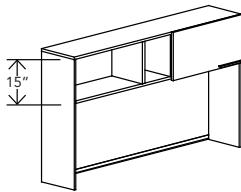

WRK-4272HSD-R

42" HIGH. DOOR HAS HANDLE. OPEN CENTER SECTION ON 72" HUTCH. 26¼" CLEARANCE TO BOTTOM OF DOOR.

|               |         |  |    |   |       |       |      |
|---------------|---------|--|----|---|-------|-------|------|
| WRK-4260HSD-R | \$1,152 |  | 90 | 4 | 59.25 | 14.75 | 41.5 |
| WRK-4272HSD-R | \$1,534 |  | 99 | 4 | 71    | 14.75 | 41.5 |

- TO ADD A SET OF 4 PLEXI COLLATOR SHELVES, **ADD '-COL' TO ITEM #** & ADD **\$369** TO RETAIL PRICE 72" HUTCHES ONLY

**RTA**

**TACKBOARDS FOR HUTCHES**

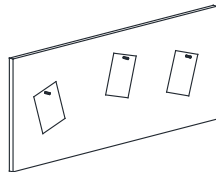
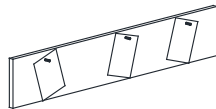

**TACK BOARDS**

|            |       |                           |    |   |    |   |    |
|------------|-------|---------------------------|----|---|----|---|----|
| WRK-2860TB | \$285 | TACK BOARD FOR 2860 HUTCH | 15 | 1 | 56 | 1 | 10 |
| WRK-2872TB | \$305 | TACK BOARD FOR 2872 HUTCH | 17 | 2 | 68 | 1 | 10 |

|            |       |                           |    |   |    |   |       |
|------------|-------|---------------------------|----|---|----|---|-------|
| WRK-4260TB | \$353 | TACK BOARD FOR 4260 HUTCH | 16 | 3 | 56 | 1 | 22.75 |
| WRK-4272TB | \$368 | TACK BOARD FOR 4272 HUTCH | 18 | 3 | 68 | 1 | 22.75 |

**NOTE:** PLEASE REFER TO THE FINISHES & FABRICS TAB ON THE [WWW.HEARTWOOD.CA](http://WWW.HEARTWOOD.CA) WEBSITE FOR A COMPLETE LISTING OF THE COLOUR CHOICES AVAILABLE IN EACH FABRIC.

**DESKTOP CUBBIES**

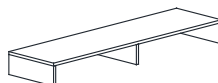

**DESKTOP CUBBIES**

|             |       |  |    |   |       |       |   |
|-------------|-------|--|----|---|-------|-------|---|
| WRK-1660DTC | \$294 |  | 30 | 3 | 59.25 | 15.75 | 6 |
| WRK-1672DTC | \$370 |  | 35 | 3 | 71    | 15.75 | 6 |

**RTA**

| MODEL | LIST | AGD        | WEIGHT | CUBE            | W  | D  | H  |
|-------|------|------------|--------|-----------------|----|----|----|
|       |      | *UP-CHARGE | LBS    | FT <sup>3</sup> | IN | IN | IN |

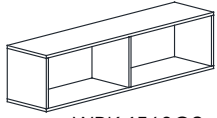

WRK-1560OS

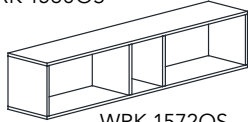

WRK-1572OS

RTA

**OPEN OVERHEAD STORAGE**

WALL HUNG. OPEN CENTER SECTION ON 72" OVERHEAD STORAGE.

|            |       |  |    |   |       |    |       |
|------------|-------|--|----|---|-------|----|-------|
| WRK-1560OS | \$676 |  | 57 | 3 | 59.25 | 14 | 14.75 |
| WRK-1572OS | \$833 |  | 66 | 3 | 71    | 14 | 14.75 |

- TO ADD A SET OF 4 PLEXI COLLATOR SHELVES, **ADD '-COL'** TO ITEM # & ADD **\$369** TO RETAIL PRICE 72" OVERHEADS ONLY  
**Example:** WRK-1572OS-COL

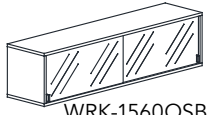

WRK-1560OSBD



WRK-1572OSBD

RTA

**OVERHEAD STORAGE W/ PLEXI BI-PASS DOORS**

WALL HUNG. DOORS HAVE HANDLES. OPEN CENTER SECTION ON 72" OVERHEAD STORAGE.

|              |         |  |    |   |       |    |       |
|--------------|---------|--|----|---|-------|----|-------|
| WRK-1560OSBD | \$1,534 |  | 61 | 3 | 59.25 | 14 | 14.75 |
| WRK-1572OSBD | \$1,671 |  | 71 | 3 | 71    | 14 | 14.75 |

- TO ADD A SET OF 4 PLEXI COLLATOR SHELVES, **ADD '-COL'** TO ITEM # & ADD **\$369** TO RETAIL PRICE 72" OVERHEADS ONLY  
**Example:** WRK-1572OSBD-COL

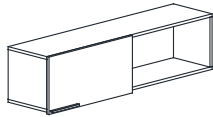

WRK-1560OSSD-L

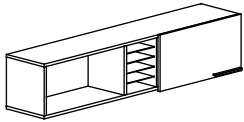

Optional COLLATOR SHELVES example:  
WRK-1572OSSD-R-COL

RTA

**OVERHEAD STORAGE W/ SLIDING DOOR - HANDLE LEFT**

WALL HUNG. DOORS HAVE HANDLES. OPEN CENTER SECTION ON 72" OVERHEAD STORAGE.

|                |         |  |    |   |       |       |       |
|----------------|---------|--|----|---|-------|-------|-------|
| WRK-1560OSSD-L | \$1,065 |  | 65 | 3 | 59.25 | 14.75 | 14.75 |
| WRK-1572OSSD-L | \$1,202 |  | 74 | 3 | 71    | 14.75 | 14.75 |

**OVERHEAD STORAGE W/ SLIDING DOOR - HANDLE RIGHT**

WALL HUNG. DOORS HAVE HANDLES. OPEN CENTER SECTION ON 72" OVERHEAD STORAGE.

|                |         |  |    |   |       |       |       |
|----------------|---------|--|----|---|-------|-------|-------|
| WRK-1560OSSD-R | \$1,065 |  | 65 | 3 | 59.25 | 14.75 | 14.75 |
| WRK-1572OSSD-R | \$1,202 |  | 74 | 3 | 71    | 14.75 | 14.75 |

- TO ADD A SET OF 4 PLEXI COLLATOR SHELVES, **ADD '-COL'** TO ITEM # & ADD **\$369** TO RETAIL PRICE , 72" OVERHEADS ONLY  
**Example:** WRK-1572OSSD-R-COL

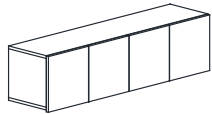

WRK-1560OSHD

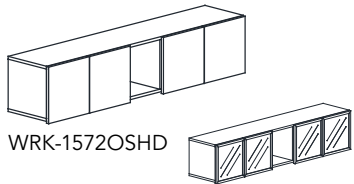

WRK-1572OSHD

Optional AGD example:  
WRK-1572OSHD-AGD-FR

RTA

**OVERHEAD STORAGE W/ HINGED DOORS**

WALL HUNG. OPEN CENTER SECTION ON 72" OVERHEAD STORAGE.

|              |         |       |    |   |       |       |       |
|--------------|---------|-------|----|---|-------|-------|-------|
| WRK-1560OSHD | \$1,079 | \$834 | 73 | 3 | 59.25 | 14.75 | 14.75 |
| WRK-1572OSHD | \$1,216 | \$834 | 82 | 3 | 71    | 14.75 | 14.75 |

- TO LOCK HUTCH DOORS, **ADD AN "L"** TO ITEM # & ADD **\$76** TO RETAIL PRICE.  
**Example:** WRK-2872MHHD-L
- TO ADD A SET OF 4 PLEXI COLLATOR SHELVES, **ADD '-COL'** TO ITEM # & ADD **\$369** TO RETAIL PRICE , 72" OVERHEADS ONLY  
**Example:** WRK-1572OSHD-COL
- OVERHEAD STORAGE DOORS DO NOT REQUIRE HANDLES. TO ADD HANDLES PLEASE REFER TO 100 SERIES (ACC) PAGE **100-5**
- **\*\* OPTIONAL ALUMINUM GLAZED DOORS \*\***
- SELECT CLEAR (CL), FROSTED (FR) OR BRONZE (BR) PLEXI GLASS
- \* THE PRICE SHOWN FOR AGD DOORS IS AN UP-CHARGE THAT MUST BE ADDED TO THE BASE PRICE OF THE UNIT IT GOES ON.



| MODEL | LIST | WEIGHT | CUBE            | W  | D  | H  |
|-------|------|--------|-----------------|----|----|----|
|       |      | LBS    | FT <sup>3</sup> | IN | IN | IN |

**BOOKCASE OVER LATERAL FILES- 57" TALL**

20" DEEP W/ 1 FIXED SHELF. LATERAL FILE DRAWERS LOCK.

|                  |         |     |    |       |       |       |
|------------------|---------|-----|----|-------|-------|-------|
| WRK-5724BKLF20-L | \$1,945 | 155 | 20 | 23.75 | 19.75 | 56.75 |
| WRK-5724BKLF20-R | \$1,945 | 155 | 20 | 23.75 | 19.75 | 56.75 |

24" DEEP W/ 1 FIXED SHELF. LATERAL FILE DRAWERS LOCK.

|                  |         |     |    |       |       |       |
|------------------|---------|-----|----|-------|-------|-------|
| WRK-5724BKLF24-L | \$2,010 | 185 | 23 | 23.75 | 23.75 | 56.75 |
| WRK-5724BKLF24-R | \$2,010 | 185 | 23 | 23.75 | 23.75 | 56.75 |



LEFT HANDLES (-L)    RIGHT HANDLES (-R)

**BOOKCASE OVER LATERAL FILES- 71" TALL**

20" DEEP W/ 2 FIXED SHELF. LATERAL FILE DRAWERS LOCK.

|                  |         |     |    |       |       |      |
|------------------|---------|-----|----|-------|-------|------|
| WRK-7124BKLF20-L | \$2,049 | 187 | 24 | 23.75 | 19.75 | 70.5 |
| WRK-7124BKLF20-R | \$2,049 | 187 | 24 | 23.75 | 19.75 | 70.5 |

24" DEEP W/ 2 FIXED SHELF. LATERAL FILE DRAWERS LOCK.

|                  |         |     |    |       |       |      |
|------------------|---------|-----|----|-------|-------|------|
| WRK-7124BKLF24-L | \$2,114 | 225 | 29 | 23.75 | 23.75 | 70.5 |
| WRK-7124BKLF24-R | \$2,114 | 225 | 29 | 23.75 | 23.75 | 70.5 |



LEFT HANDLES (-L)    RIGHT HANDLES (-R)

**TURNED BOOKCASE OVER LATERAL FILES- 57" TALL**

20" DEEP W/ 1 FIXED SHELF. LATERAL FILE DRAWERS LOCK.

|                   |         |     |    |       |       |       |
|-------------------|---------|-----|----|-------|-------|-------|
| WRK-5724TBKLF20-L | \$1,982 | 155 | 20 | 23.75 | 19.75 | 56.75 |
| WRK-5724TBKLF20-R | \$1,982 | 155 | 20 | 23.75 | 19.75 | 56.75 |

24" DEEP W/ 1 FIXED SHELF. LATERAL FILE DRAWERS LOCK.

|                   |         |     |    |       |       |       |
|-------------------|---------|-----|----|-------|-------|-------|
| WRK-5724TBKLF24-L | \$2,049 | 185 | 23 | 23.75 | 23.75 | 56.75 |
| WRK-5724TBKLF24-R | \$2,049 | 185 | 23 | 23.75 | 23.75 | 56.75 |



LEFT HANDLES (-L)    RIGHT HANDLES (-R)

**TURNED BOOKCASE OVER LATERAL FILES- 71" TALL**

20" DEEP W/ 2 FIXED SHELVES. LATERAL FILE DRAWERS LOCK.

|                   |         |     |    |       |       |      |
|-------------------|---------|-----|----|-------|-------|------|
| WRK-7124TBKLF20-L | \$2,087 | 187 | 24 | 23.75 | 19.75 | 70.5 |
| WRK-7124TBKLF20-R | \$2,087 | 187 | 24 | 23.75 | 19.75 | 70.5 |

24" DEEP W/ 2 FIXED SHELVES. LATERAL FILE DRAWERS LOCK.

|                   |         |     |    |       |       |      |
|-------------------|---------|-----|----|-------|-------|------|
| WRK-7124TBKLF24-L | \$2,152 | 225 | 29 | 23.75 | 23.75 | 70.5 |
| WRK-7124TBKLF24-R | \$2,152 | 225 | 29 | 23.75 | 23.75 | 70.5 |



LEFT HANDLES (-L)    RIGHT HANDLES (-R)

| MODEL | LIST | AGD        | WEIGHT | CUBE            | W  | D  | H  |
|-------|------|------------|--------|-----------------|----|----|----|
|       |      | *UP-CHARGE | LBS    | FT <sup>3</sup> | IN | IN | IN |

**WARDROBE CABINET/BOOKCASE OVER LATERAL FILES**

20" DEEP W/ 2 FIXED SHELVES. LATERAL FILE DRAWERS & HINGED CABINET DOOR LOCK.

|                    |         |       |     |    |       |       |      |
|--------------------|---------|-------|-----|----|-------|-------|------|
| WRK-7124WCBKLF20-L | \$2,309 | \$406 | 207 | 24 | 23.75 | 19.75 | 70.5 |
|--------------------|---------|-------|-----|----|-------|-------|------|

24" DEEP W/ 2 FIXED SHELVES. LATERAL FILE DRAWERS & HINGED CABINET DOOR LOCK.

|                    |         |       |     |    |       |       |      |
|--------------------|---------|-------|-----|----|-------|-------|------|
| WRK-7124WCBKLF24-L | \$2,373 | \$406 | 250 | 29 | 23.75 | 23.75 | 70.5 |
|--------------------|---------|-------|-----|----|-------|-------|------|

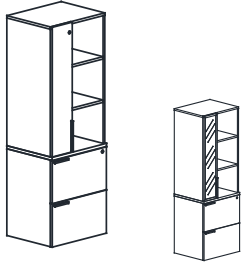

Optional AGD example:  
WRK-7124WCBKLF20-L-AGD-FR

**BOOKCASE/WARDROBE CABINET OVER LATERAL FILES**

20" DEEP W/ 2 FIXED SHELVES. LATERAL FILE DRAWERS & HINGED CABINET DOOR LOCK.

|                    |         |       |     |    |       |       |      |
|--------------------|---------|-------|-----|----|-------|-------|------|
| WRK-7124BKWCLF20-R | \$2,309 | \$406 | 207 | 24 | 23.75 | 19.75 | 70.5 |
|--------------------|---------|-------|-----|----|-------|-------|------|

24" DEEP W/ 2 FIXED SHELVES. LATERAL FILE DRAWERS & HINGED CABINET DOOR LOCK.

|                    |         |       |     |    |       |       |      |
|--------------------|---------|-------|-----|----|-------|-------|------|
| WRK-7124BKWCLF24-R | \$2,373 | \$406 | 250 | 29 | 23.75 | 23.75 | 70.5 |
|--------------------|---------|-------|-----|----|-------|-------|------|

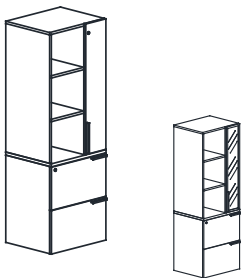

Optional AGD example:  
WRK-7124BKWCLF20-R-AGD-FR

**\*\* OPTIONAL ALUMINUM GLAZED DOORS \*\***

- SELECT CLEAR (CL), FROSTED (FR) OR BRONZE (BR) PLEXI GLASS
- AGD DOORS INCLUDE SILVER FINISH BAR HANDLES.
- PLEASE REFER TO 100 SERIES (ACC) PAGE **100-3** FOR OTHER HANDLE CHOICES.
- THE PRICE SHOWN FOR AGD DOORS IS AN UP-CHARGE THAT MUST BE ADDED TO THE BASE PRICE OF THE UNIT IT GOES ON.

**WARDROBE CABINET/TURNED BOOKCASE OVER LATERAL FILES**

20" DEEP W/ 2 FIXED SHELVES. LATERAL FILE DRAWERS & HINGED CABINET DOOR LOCK.

|                     |         |       |     |    |       |       |      |
|---------------------|---------|-------|-----|----|-------|-------|------|
| WRK-7124WCTBKLF20-L | \$2,367 | \$424 | 207 | 24 | 23.75 | 19.75 | 70.5 |
|---------------------|---------|-------|-----|----|-------|-------|------|

24" DEEP W/ 2 FIXED SHELVES. LATERAL FILE DRAWERS & HINGED CABINET DOOR LOCK.

|                     |         |       |     |    |       |       |      |
|---------------------|---------|-------|-----|----|-------|-------|------|
| WRK-7124WCTBKLF24-L | \$2,438 | \$424 | 250 | 29 | 23.75 | 23.75 | 70.5 |
|---------------------|---------|-------|-----|----|-------|-------|------|

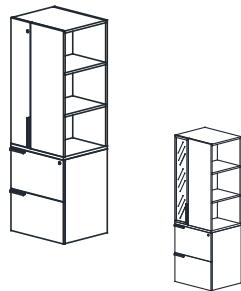

Optional AGD example:  
WRK-7124WCTBKLF20-L-AGD-FR

**TURNED BOOKCASE/WARDROBE CABINET OVER LATERAL FILES**

20" DEEP W/ 2 FIXED SHELVES. LATERAL FILE DRAWERS & HINGED CABINET DOOR LOCK.

|                     |         |       |     |    |       |       |      |
|---------------------|---------|-------|-----|----|-------|-------|------|
| WRK-7124TBKWCLF20-R | \$2,367 | \$424 | 207 | 24 | 23.75 | 19.75 | 70.5 |
|---------------------|---------|-------|-----|----|-------|-------|------|

24" DEEP W/ 2 FIXED SHELVES. LATERAL FILE DRAWERS & HINGED CABINET DOOR LOCK.

|                     |         |       |     |    |       |       |      |
|---------------------|---------|-------|-----|----|-------|-------|------|
| WRK-7124TBKWCLF24-R | \$2,438 | \$424 | 250 | 29 | 23.75 | 23.75 | 70.5 |
|---------------------|---------|-------|-----|----|-------|-------|------|

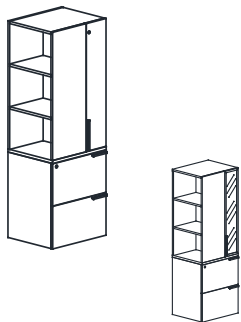

Optional AGD example:  
WRK-7124TBKWCLF20-R-AGD-FR

**\*\* OPTIONAL ALUMINUM GLAZED DOORS \*\***

- SELECT CLEAR (CL), FROSTED (FR) OR BRONZE (BR) PLEXI GLASS
- AGD DOORS INCLUDE SILVER FINISH BAR HANDLES.
- PLEASE REFER TO 100 SERIES (ACC) PAGE **100-3** FOR OTHER HANDLE CHOICES.
- \* THE PRICE SHOWN FOR AGD DOORS IS AN UP-CHARGE THAT MUST BE ADDED TO THE BASE PRICE OF THE UNIT IT GOES ON.

| MODEL | LIST | AGD        | WEIGHT | CUBE            | W  | D  | H  |
|-------|------|------------|--------|-----------------|----|----|----|
|       |      | *UP-CHARGE | LBS    | FT <sup>3</sup> | IN | IN | IN |

**WARDROBE CABINET/STORAGE OVER LATERAL FILES**

20" DEEP W/ 2 FIXED SHELVES. LATERAL FILE DRAWERS & HINGED CABINET DOORS LOCK.

|                   |         |       |     |    |       |       |      |
|-------------------|---------|-------|-----|----|-------|-------|------|
| WRK-7124WCSLF20-L | \$2,205 | \$826 | 222 | 24 | 23.75 | 19.75 | 70.5 |
|-------------------|---------|-------|-----|----|-------|-------|------|

24" DEEP W/ 2 FIXED SHELVES. LATERAL FILE DRAWERS & HINGED CABINET DOORS LOCK.

|                   |         |       |     |    |       |       |      |
|-------------------|---------|-------|-----|----|-------|-------|------|
| WRK-7124WCSLF24-L | \$2,281 | \$826 | 265 | 29 | 23.75 | 23.75 | 70.5 |
|-------------------|---------|-------|-----|----|-------|-------|------|

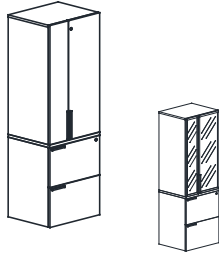

Optional AGD example:  
WRK-7124WCSLF20-L-AGD-FR

**STORAGE/WARDROBE CABINET OVER LATERAL FILES**

20" DEEP W/ 2 FIXED SHELVES. LATERAL FILE DRAWERS & HINGED CABINET DOORS LOCK.

|                   |         |       |     |    |       |       |      |
|-------------------|---------|-------|-----|----|-------|-------|------|
| WRK-7124SWCLF20-R | \$2,205 | \$826 | 222 | 24 | 23.75 | 19.75 | 70.5 |
|-------------------|---------|-------|-----|----|-------|-------|------|

24" DEEP W/ 2 FIXED SHELVES. LATERAL FILE DRAWERS & HINGED CABINET DOORS LOCK.

|                   |         |       |     |    |       |       |      |
|-------------------|---------|-------|-----|----|-------|-------|------|
| WRK-7124SWCLF24-R | \$2,281 | \$826 | 265 | 29 | 23.75 | 23.75 | 70.5 |
|-------------------|---------|-------|-----|----|-------|-------|------|

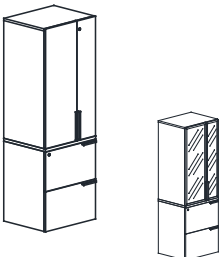

Optional AGD example:  
WRK-7124SWCLF20-R-AGD-FR

**\*\* OPTIONAL ALUMINUM GLAZED DOORS \*\***

- SELECT CLEAR (CL), FROSTED (FR) OR BRONZE (BR) PLEXI GLASS
- AGD DOORS INCLUDE SILVER FINISH BAR HANDLES.
- PLEASE REFER TO 100 SERIES (ACC) PAGE **100-3** FOR OTHER HANDLE CHOICES.
- THE PRICE SHOWN FOR AGD DOORS IS AN UP-CHARGE THAT MUST BE ADDED TO THE BASE PRICE OF THE UNIT IT GOES ON.

**MID-HEIGHT CLOSET CABINET**

INCLUDES COAT ROD. DRILLED FOR OPTIONAL BOOT SHELF.  
HINGED LEFT

|                 |         |       |    |      |       |       |       |
|-----------------|---------|-------|----|------|-------|-------|-------|
| WRK-4712MCL24-L | \$989   | \$442 | 74 | 8.7  | 11.75 | 23.75 | 46.75 |
| WRK-4724MCL24-L | \$1,385 | \$475 | 90 | 16.9 | 23.75 | 23.75 | 46.75 |

HINGED RIGHT (SHOWN)

|                 |         |       |    |      |       |       |       |
|-----------------|---------|-------|----|------|-------|-------|-------|
| WRK-4712MCL24-R | \$989   | \$442 | 74 | 8.7  | 11.75 | 23.75 | 46.75 |
| WRK-4724MCL24-R | \$1,385 | \$475 | 90 | 16.9 | 23.75 | 23.75 | 46.75 |

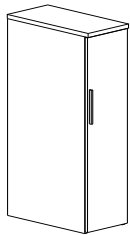

WRK-4712MCL24-R

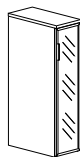

Optional AGD example:  
WRK-4712MCL24-R-AGD-FR

- DOOR LOCK OPTIONAL, **ADD AN '-L' TO ITEM #** & ADD UPCHARGE OF **\$76**  
**Example:**WRK-4724MCL24-L- L

**\*\* OPTIONAL ALUMINUM GLAZED DOORS \*\***

- SELECT CLEAR (CL), FROSTED (FR) OR BRONZE (BR) PLEXI GLASS  
**Example:** WRK-4712MCL24-R-AGD-FR
- AGD DOORS INCLUDE SILVER FINISH BAR HANDLES. PLEASE REFER TO 100 SERIES (ACC) PAGE **100-3** FOR OTHER HANDLE CHOICES.
- \* THE PRICE SHOWN FOR AGD DOORS IS AN UP-CHARGE THAT MUST BE ADDED TO THE BASE PRICE OF THE UNIT IT GOES ON.

**BOOT SHELF**

TO FIT 12" WIDE MCL

|            |       |  |    |     |       |       |   |
|------------|-------|--|----|-----|-------|-------|---|
| WRK-1224BS | \$120 |  | 11 | 0.4 | 11.75 | 23.75 | 1 |
|------------|-------|--|----|-----|-------|-------|---|

TO FIT 24" WIDE MCL

|            |       |  |    |     |       |       |   |
|------------|-------|--|----|-----|-------|-------|---|
| WRK-2424BS | \$135 |  | 18 | 0.7 | 23.75 | 23.75 | 1 |
|------------|-------|--|----|-----|-------|-------|---|

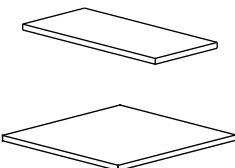

| MODEL | LIST | AGD        | WEIGHT | CUBE            | W  | D  | H  |
|-------|------|------------|--------|-----------------|----|----|----|
|       |      | *UP-CHARGE | LBS    | FT <sup>3</sup> | IN | IN | IN |

**MID-HEIGHT WARDROBE STORAGE**

CABINET/BOX/BOX/FILE WARDROBE LEFT  
INCLUDES COAT ROD, 1 FIXED SHELF & 1 ADJUSTABLE SHELF. WARDROBE AND DRAWERS ARE LOCKING. OPTIONAL LOCK ON CABINET DOOR.

|                  |         |       |     |      |       |       |       |
|------------------|---------|-------|-----|------|-------|-------|-------|
| WRK-4724CUFWL-24 | \$1,658 | \$826 | 190 | 16.9 | 23.75 | 23.75 | 46.75 |
| WRK-5724CUFWL-24 | \$2,196 | \$826 | 215 | 20.4 | 23.75 | 23.75 | 56.75 |

CABINET/BOX/BOX/FILE WARDROBE RIGHT  
INCLUDES COAT ROD, 1 FIXED SHELF & 1 ADJUSTABLE SHELF. WARDROBE AND DRAWERS ARE LOCKING. OPTIONAL LOCK ON CABINET DOOR.

|                  |         |       |     |      |       |       |       |
|------------------|---------|-------|-----|------|-------|-------|-------|
| WRK-4724CUFWR-24 | \$1,658 | \$826 | 190 | 16.9 | 23.75 | 23.75 | 46.75 |
| WRK-5724CUFWR-24 | \$2,196 | \$826 | 215 | 20.4 | 23.75 | 23.75 | 56.75 |

**\*OPTIONAL ALUMINUM GLAZED DOORS\***

- SELECT CLEAR (CL), FROSTED (FR) OR BRONZE (BR) PLEXI GLASS
- AGD DOORS INCLUDE SILVER FINISH BAR HANDLES. PLEASE REFER TO 100 SERIES (ACC) PAGE [100-3](#) FOR OTHER HANDLE CHOICES.
- THE PRICE SHOWN FOR AGD DOORS IS AN UP-CHARGE THAT MUST BE ADDED TO THE BASE PRICE OF THE UNIT IT GOES ON.

**Example:** WRK-5724CUFWL-24 - AGD-FR

- DOOR LOCK OPTIONAL, ADD AN '-L' TO ITEM # & ADD UPCHARGE OF **\$76**  
**Example:** WRK-5724CUFWL-24 - L

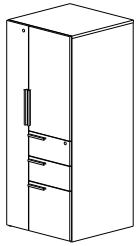

WRK-5724CUFWL-24



Optional AGD example:  
WRK-5724CUFWL-24-AGD-FR

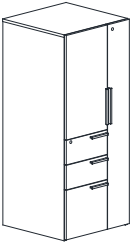

WRK-5724CUFWR-24



Optional AGD example:  
WRK-4724CUFWR-24-AGD-FR

**MID-HEIGHT WARDROBE STORAGE**

CABINET/FILEWARDROBE LEFT  
INCLUDES COAT ROD, 1 FIXED SHELF & 1 ADJUSTABLE SHELF. WARDROBE AND FILE DRAWER ARE LOCKING.

|                 |         |       |     |      |       |       |       |
|-----------------|---------|-------|-----|------|-------|-------|-------|
| WRK-4724CFWL-24 | \$1,671 | \$826 | 180 | 16.9 | 23.75 | 23.75 | 46.75 |
| WRK-5724CFWL-24 | \$1,723 | \$826 | 201 | 20.4 | 23.75 | 23.75 | 56.75 |

CABINET/FILE WARDROBE RIGHT  
INCLUDES COAT ROD, 1 FIXED SHELF & 1 ADJUSTABLE SHELF. WARDROBE AND FILE DRAWER ARE LOCKING.

|                 |         |       |     |      |       |       |       |
|-----------------|---------|-------|-----|------|-------|-------|-------|
| WRK-4724CFWR-24 | \$1,671 | \$826 | 180 | 16.9 | 23.75 | 23.75 | 46.75 |
| WRK-5724CFWR-24 | \$1,723 | \$826 | 201 | 20.4 | 23.75 | 23.75 | 56.75 |

**\*OPTIONAL ALUMINUM GLAZED DOORS\***

- SELECT CLEAR (CL), FROSTED (FR) OR BRONZE (BR) PLEXI GLASS
- AGD DOORS INCLUDE SILVER FINISH BAR HANDLES. PLEASE REFER TO 100 SERIES (ACC) PAGE [100-3](#) FOR OTHER HANDLE CHOICES.
- THE PRICE SHOWN FOR AGD DOORS IS AN UP-CHARGE THAT MUST BE ADDED TO THE BASE PRICE OF THE UNIT IT GOES ON.

**Example:** WRK-4724CFWL-24 - AGD-FR

- DOOR LOCK OPTIONAL, **ADD AN '-L' TO ITEM #** & ADD UPCHARGE OF **\$76**  
**Example:** WRK-4724CFWL-24 -L

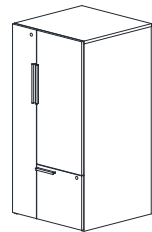

WRK-4724CFWL-24

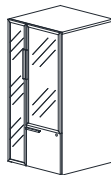

Optional AGD example:  
WRK-4724CFWL-24-AGD-FR

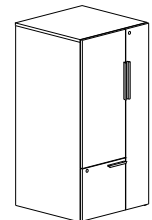

WRK-4724CFWR-24

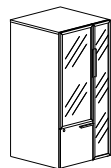

Optional AGD example:  
WRK-4724CFWR-24 - AGD-FR

| MODEL | LIST | AGD        | WEIGHT | CUBE            | W  | D  | H  |
|-------|------|------------|--------|-----------------|----|----|----|
|       |      | *UP-CHARGE | LBS    | FT <sup>3</sup> | IN | IN | IN |

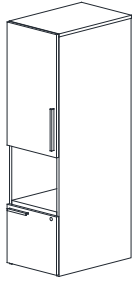

WRK-5716COF24-L

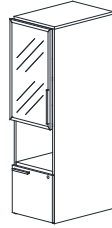

Optional AGD example:  
WRK-5716COF24-L-AGD-FR

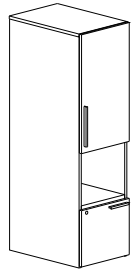

WRK-5716COF24-R

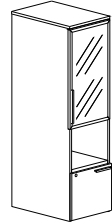

Optional AGD example:  
WRK-5716COF24-R-AGD-FR

**MID-HEIGHT CABINET/ OPEN/FILE DRAWER CABINET**

INCLUDES 2 FIXED SHELVES, 1 ADJUSTABLE SHELF & LOCKING FILE DRAWER

HINGED LEFT

|                 |         |       |     |      |       |       |       |
|-----------------|---------|-------|-----|------|-------|-------|-------|
| WRK-4716COF24-L | \$897   | \$299 | 79  | 11.4 | 15.75 | 23.75 | 46.75 |
| WRK-5716COF24-L | \$1,362 | \$367 | 120 | 13.8 | 15.75 | 23.75 | 56.75 |

HINGED RIGHT

|                 |         |       |     |      |       |       |       |
|-----------------|---------|-------|-----|------|-------|-------|-------|
| WRK-4716COF24-R | \$897   | \$299 | 79  | 11.4 | 15.75 | 23.75 | 46.75 |
| WRK-5716COF24-R | \$1,362 | \$367 | 120 | 13.8 | 15.75 | 23.75 | 56.75 |

**\*OPTIONAL ALUMINUM GLAZED DOORS\***

- SELECT CLEAR (CL), FROSTED (FR) OR BRONZE (BR) PLEXI GLASS
- AGD DOORS INCLUDE SILVER FINISH BAR HANDLES. PLEASE REFER TO 100 SERIES (ACC) PAGE 100-3 FOR OTHER HANDLE CHOICES.
- THE PRICE SHOWN FOR AGD DOORS IS AN UP-CHARGE THAT MUST BE ADDED TO THE BASE PRICE OF THE UNIT IT GOES ON.

**Example:** WRK-4716COF24-R - AGD-FR

- TO LOCK CABINET DOOR, ADD AN 'L' TO ITEM # & ADD UPCHARGE OF **\$76**
- Example:** WRK-4716COF24-R - L

**BOOKCASES**

**43" OPEN BOOKCASES**

3 FIXED SHELVES

|            |       |    |   |       |    |      |
|------------|-------|----|---|-------|----|------|
| WRK-4324BK | \$546 | 68 | 2 | 23.75 | 14 | 42.5 |
| WRK-4330BK | \$583 | 78 | 2 | 29.75 | 14 | 42.5 |
| WRK-4336BK | \$619 | 89 | 2 | 35.5  | 14 | 42.5 |

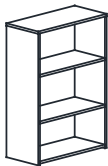

RTA

**57" OPEN BOOKCASES**

4 FIXED SHELVES

|            |       |     |   |       |    |       |
|------------|-------|-----|---|-------|----|-------|
| WRK-5724BK | \$632 | 86  | 2 | 23.75 | 14 | 56.25 |
| WRK-5730BK | \$674 | 100 | 2 | 29.75 | 14 | 56.25 |
| WRK-5736BK | \$714 | 114 | 2 | 35.5  | 14 | 56.25 |



RTA

**71" OPEN BOOKCASES**

5 FIXED SHELVES

|            |       |     |   |       |    |    |
|------------|-------|-----|---|-------|----|----|
| WRK-7124BK | \$783 | 100 | 3 | 23.75 | 14 | 70 |
| WRK-7130BK | \$814 | 115 | 3 | 29.75 | 14 | 70 |
| WRK-7136BK | \$850 | 130 | 3 | 35.5  | 14 | 70 |

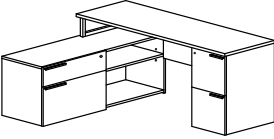

RTA

|  | ITEMS             | ITEM DESCRIPTION                                       | LIST           |
|--|-------------------|--|----------------|
|  <p>TOTAL DIMENSIONS: 59.25" X 71"<br/>TOTAL WEIGHT: 329.9lb / 150.1kg<br/>TOTAL CUBES: 26.9ft<sup>3</sup> / .7626m<sup>3</sup></p> | <b>LAYOUT #1</b>  |  |                |
|  | WRK-WDLF2060CO-21 | 21" HIGH WIDE DRAWER/LATERAL FILE, OPEN SHELF CREDENZA | <b>\$1,347</b> |
|  | WRK-2472WS        | 24" DEEP WORK SURFACE TOP                              | <b>\$392</b>   |
|  | 100-WSB-52        | WORK SURFACE STIFFENER BAR                             | <b>\$82</b>    |
|  | WRK-24MWR         | METAL 7" - WORK SURFACE RISER                          | <b>\$172</b>   |
|  | WRK-1436LMPS      | LAMINATE 1/2 HEIGHT MODESTY PANEL - SUSPENDED          | <b>\$189</b>   |
|  | WRK-1624FPFFX-R   | FILE/FILE, NO TOP PEDESTAL                             | <b>\$882</b>   |
|  |                   | <b>TOTAL</b>   | <b>\$3,064</b> |

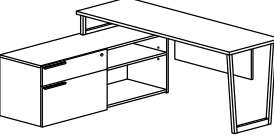
|   |                   |  |                |
|---|-------------------|--|----------------|
|  <p>TOTAL DIMENSIONS: 59.25" X 71"<br/>TOTAL WEIGHT: 314.07 lb / 120.23 kg<br/>TOTAL CUBES: 21.86 ft<sup>3</sup> / .6211 m<sup>3</sup></p> | <b>LAYOUT #2</b>  |  |                |
|   | WRK-WDLF2060CO-21 | 21" HIGH WIDE DRAWER/LATERAL FILE, OPEN SHELF CREDENZA | <b>\$1,347</b> |
|   | WRK-2472WS        | 24" DEEP WORK SURFACE TOP                              | <b>\$392</b>   |
|   | 100-WSB-64        | WORK SURFACE STIFFENER BAR                             | <b>\$82</b>    |
|   | WRK-24MWR         | METAL 7" - WORK SURFACE RISER                          | <b>\$172</b>   |
|   | WRK-1436LMPS      | LAMINATE 1/2 HEIGHT MODESTY PANEL - SUSPENDED          | <b>\$189</b>   |
|   | WRK-24MVLEG       | METAL V-LEG  | <b>\$219</b>   |
|   |                   | <b>TOTAL</b>   | <b>\$2,401</b> |

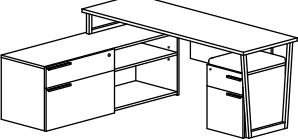
|   |                   |  |                |
|---|-------------------|--|----------------|
|  <p>TOTAL DIMENSIONS: 59.25" X 71"<br/>TOTAL WEIGHT: 338.07 lb / 152.03 kg<br/>TOTAL CUBES: 27.86 ft<sup>3</sup> / .8011 m<sup>3</sup></p> | <b>LAYOUT #3</b>  |  |                |
|   | WRK-WDLF2060CO-21 | 21" HIGH WIDE DRAWER/LATERAL FILE, OPEN SHELF CREDENZA | <b>\$1,347</b> |
|   | WRK-2472WS        | 24" DEEP WORK SURFACE TOP                              | <b>\$392</b>   |
|   | 100-WSB-64        | WORK SURFACE STIFFENER BAR                             | <b>\$82</b>    |
|   | WRK-24MWR         | METAL 7" - WORK SURFACE RISER                          | <b>\$172</b>   |
|   | WRK-1436LMPS      | LAMINATE 1/2 HEIGHT MODESTY PANEL - SUSPENDED          | <b>\$189</b>   |
|   | WRK-24MVLEG       | METAL V-LEG  | <b>\$219</b>   |
|   | WRK-1621MPF-R     | 21" MOBILE PEDESTAL                                    | <b>\$800</b>   |
| WRK-MPEDCUSH-ESC  | PEDESTAL CUSHION  | <b>\$393</b>   |                |
|   |                   | <b>TOTAL</b>   | <b>\$3,594</b> |

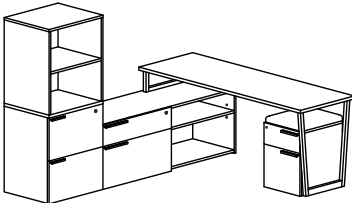
|   |                   |  |                |
|---|-------------------|--|----------------|
|  <p>TOTAL DIMENSIONS: 82.75" x 71"<br/>TOTAL WEIGHT: 474.457 lb / 218.03 kg<br/>TOTAL CUBES: 47.63 ft<sup>3</sup> / 1.3441 m<sup>3</sup></p> | <b>LAYOUT #4</b>  |  |                |
|   | WRK-5724BKLF20-L  | BOOKCASE OVER LATERAL FILES - HANDLES LEFT             | <b>\$1,945</b> |
|   | WRK-WDLF2060CO-21 | 21" HIGH WIDE DRAWER/LATERAL FILE, OPEN SHELF CREDENZA | <b>\$1,347</b> |
|   | WRK-2472WS        | 24" DEEP WORK SURFACE TOP                              | <b>\$392</b>   |
|   | 100-WSB-64        | WORK SURFACE STIFFENER BAR                             | <b>\$82</b>    |
|   | WRK-24MWR         | METAL 7" - WORK SURFACE RISER                          | <b>\$172</b>   |
|   | WRK-24MVLEG       | METAL V-LEG  | <b>\$219</b>   |
|   | WRK-1621MPF-R     | 21" MOBILE PEDESTAL                                    | <b>\$800</b>   |
| WRK-MPEDCUSH-ESC  | PEDESTAL CUSHION  | <b>\$393</b>   |                |
|   |                   | <b>TOTAL</b>   | <b>\$5,350</b> |

| ITEMS | ITEM DESCRIPTION | LIST |
|-------|------------------|------|
|-------|------------------|------|

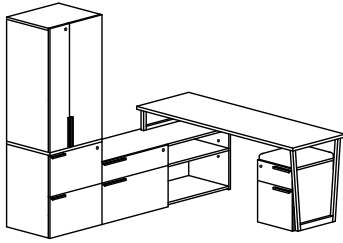

TOTAL DIMENSIONS: 82.75" x 71"  
 TOTAL WEIGHT: 545.27 lb / 248.43 kg  
 TOTAL CUBES: 51.63 ft<sup>3</sup> / 1.4641 m<sup>3</sup>

**LAYOUT #5**

|                   |  |                |
|-------------------|--|----------------|
| WRK-7124WCSLF20-L | WARDROBE CABINET/STORAGE OVER LATERAL FILES            | <b>\$2,205</b> |
| WRK-WDLF2060CO-21 | 21" HIGH WIDE DRAWER/LATERAL FILE, OPEN SHELF CREDENZA | <b>\$1,347</b> |
| WRK-2472WS        | 24" DEEP WORK SURFACE TOP                              | <b>\$392</b>   |
| 100-WSB-64        | WORK SURFACE STIFFENER BAR                             | <b>\$82</b>    |
| WRK-24MWR         | METAL 7" - WORK SURFACE RISER                          | <b>\$172</b>   |
| WRK-24MVLEG       | METAL V-LEG  | <b>\$219</b>   |
| WRK-1621MPF-R     | 21" MOBILE PEDESTAL                                    | <b>\$800</b>   |
| WRK-MPEDCUSH-ESC  | PEDESTAL CUSHION                                       | <b>\$393</b>   |
| <b>TOTAL</b>      |  | <b>\$5,610</b> |

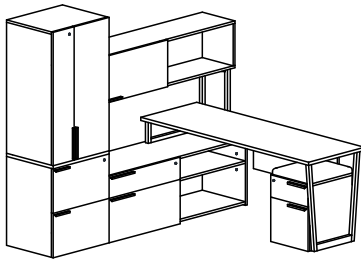

TOTAL DIMENSIONS: 82.75" x 72"  
 TOTAL WEIGHT: 630.07 lb / 287.03 kg  
 TOTAL CUBES: 54.86 ft<sup>3</sup> / 1.5484 m<sup>3</sup>

**LAYOUT #6**

|                   |  |                |
|-------------------|--|----------------|
| WRK-7124WCSLF20-L | WARDROBE CABINET/STORAGE OVER LATERAL FILES            | <b>\$2,205</b> |
| WRK-WDLF2060CO-21 | 21" HIGH WIDE DRAWER/LATERAL FILE, OPEN SHELF CREDENZA | <b>\$1,347</b> |
| WRK-3660MHSD-L    | HUTCHES W/ METAL SUPPORTS & SLIDING DOOR - HANDLE LEFT | <b>\$1,268</b> |
| WRK-2472WS        | 24" DEEP WORK SURFACE TOP                              | <b>\$392</b>   |
| 100-WSB-64        | WORK SURFACE STIFFENER BAR                             | <b>\$82</b>    |
| WRK-24MWR         | METAL 7" - WORK SURFACE RISER                          | <b>\$172</b>   |
| WRK-1436LMPS      | LAMINATE 1/2 HEIGHT MODESTY PANEL - SUSPENDED          | <b>\$189</b>   |
| WRK-24MVLEG       | METAL V-LEG  | <b>\$219</b>   |
| WRK-1621MPF-R     | 21" MOBILE PEDESTAL                                    | <b>\$800</b>   |
| WRK-MPEDCUSH-ESC  | PEDESTAL CUSHION                                       | <b>\$393</b>   |
| <b>TOTAL</b>      |  | <b>\$7,067</b> |

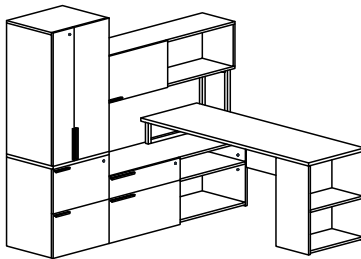

TOTAL DIMENSIONS: 82.75" x 72"  
 TOTAL WEIGHT: 592.56 lb / 269.35 kg  
 TOTAL CUBES: 48.675 ft<sup>3</sup> / 1.5813 m<sup>3</sup>

**LAYOUT #7**

|                   |  |                |
|-------------------|--|----------------|
| WRK-7124WCSLF20-L | WARDROBE CABINET/STORAGE OVER LATERAL FILES            | <b>\$2,205</b> |
| WRK-WDLF2060CO-21 | 21" HIGH WIDE DRAWER/LATERAL FILE, OPEN SHELF CREDENZA | <b>\$1,347</b> |
| WRK-3660MHSD-L    | HUTCHES W/ METAL SUPPORTS & SLIDING DOOR - HANDLE LEFT | <b>\$1,268</b> |
| WRK-2472WS        | 24" DEEP WORK SURFACE TOP                              | <b>\$392</b>   |
| 100-WSB-52        | WORK SURFACE STIFFENER BAR                             | <b>\$82</b>    |
| WRK-24MWR         | METAL 7" - WORK SURFACE RISER                          | <b>\$172</b>   |
| WRK-1430LMPS      | LAMINATE 1/2 HEIGHT MODESTY PANEL - SUSPENDED          | <b>\$175</b>   |
| WRK-1624BKX       | OPEN BOOKCASE - NO TOP                                 | <b>\$614</b>   |
| <b>TOTAL</b>      |  | <b>\$6,255</b> |

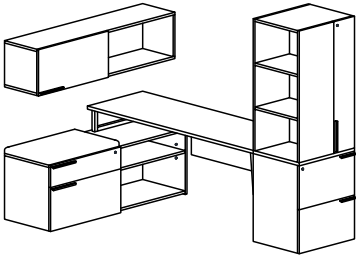
|   | ITEMS               | ITEM DESCRIPTION                                       | LIST           |
|---|---------------------|--|----------------|
|  | <b>LAYOUT #8</b>    |  |                |
|   | WRK-WDLF2060CO-21   | 21" HIGH WIDE DRAWER/LATERAL FILE, OPEN SHELF CREDENZA | \$1,347        |
|   | WRK-2030CUSH-ESC    | CREDENZA SEAT CUSHION- REF PG WRK-10 FOR OPTIONS       | \$457          |
|   | WRK-1560OSSD-L      | OVERHEAD STORAGE WITH SLIDING DOOR - HANDLE LEFT       | \$1,065        |
|   | WRK-2472WS          | 24" DEEP WORK SURFACE TOP                              | \$392          |
|   | 100-WSB-64          | WORK SURFACE STIFFENER BAR                             | \$82           |
|   | WRK-24MWR           | METAL 7" - WORK SURFACE RISER                          | \$172          |
|   | WRK-1442LMPS        | LAMINATE 1/2 HEIGHT MODESTY PANEL - SUSPENDED          | \$215          |
|   | WRK-24MVLEG         | METAL V-LEG  | \$219          |
|   | WRK-7124TBKWCLF20-R | TURNED BOOKCASE/WARDROBE CABINET OVER LATERAL FILES    | \$2,367        |
|   |                     | <b>TOTAL</b>   | <b>\$6,316</b> |

TOTAL DIMENSIONS: 59.25" x 90.75"  
 TOTAL WEIGHT: 545.64 lb / 248.13 kg  
 TOTAL CUBES: 50.89 ft<sup>3</sup> / 1.4231 m<sup>3</sup>

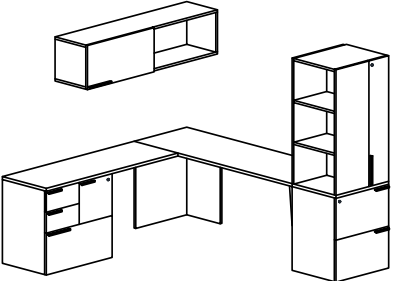
|  |                     |  |                |
|--|---------------------|--|----------------|
|  | <b>LAYOUT #9</b>    |  |                |
|  | WRK-2030UFLX        | BOX/BOX/FILE LATERAL FILE COMBO UNITS - HANDLES LEFT - 20" DEEP - NO TOP | \$1,255        |
|  | WRK-2060WS          | 20" DEEP WORK SURFACE TOP  | \$287          |
|  | WRK-WFBK            | WORK SURFACE FLUSH BRACKET KIT   | \$36           |
|  | WRK-1624ESG-L       | END SUPPORT GABLE - LEFT   | \$157          |
|  | WRK-1560OSSD-L      | OVERHEAD STORAGE WITH SLIDING DOOR - HANDLE LEFT                         | \$1,065        |
|  | WRK-2472WS          | 24" DEEP WORK SURFACE TOP  | \$392          |
|  | 100-WSB-52          | WORK SURFACE STIFFENER BAR   | \$82           |
|  | WRK-24MVLEG         | METAL V-LEG  | \$219          |
|  | WRK-7124TBKWCLF20-R | TURNED BOOKCASE/WARDROBE CABINET OVER LATERAL FILES                      | \$2,367        |
|  |                     | <b>TOTAL</b>   | <b>\$5,860</b> |

TOTAL DIMENSIONS: 82.75" x 90.75"  
 TOTAL WEIGHT: 496.68 lb / 225.94 kg  
 TOTAL CUBES: 44.01 ft<sup>3</sup> / 1.2125 m<sup>3</sup>

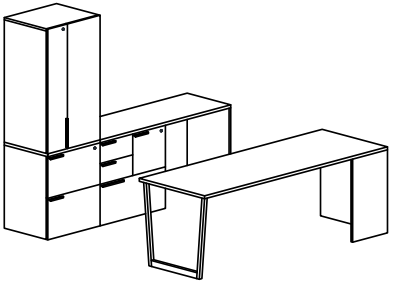
|   |                     |  |              |
|---|---------------------|--|--------------|
|  | <b>LAYOUT #10</b>   |  |              |
|   | WRK-7124WCTBKLF20-L | WARDROBE CABINET/TURNED BOOKCASE OVER LATERAL FILES                      | \$2,367      |
|   | WRK-2060WS          | 20" DEEP WORK SURFACE TOP  | \$287        |
|   | WRK-2030UFLX        | BOX/BOX/FILE LATERAL FILE COMBO UNITS - HANDLES LEFT - 20" DEEP - NO TOP | \$1,255      |
|   | WRK-1620ESG-R       | END SUPPORT GABLE - RIGHT  | \$142        |
|   | WRK-3072WS          | 30" DEEP WORK SURFACE  | \$437        |
|   | 100-WSB-52          | WORK SURFACE STIFFENER BAR   | \$82         |
|   | WRK-1630ESG-L       | END SUPPORT GABLE - LEFT   | \$169        |
|   | WRK-30MVLEG         | METAL V-LEG  | \$250        |
|   |                     |  | <b>TOTAL</b> |

TOTAL DIMENSIONS: 82.75" x 94.75"  
 TOTAL WEIGHT: 475.01 lb / 216.13 kg  
 TOTAL CUBES: 42.493 ft<sup>3</sup> / 1.175 m<sup>3</sup>

\*NOTE: DIMENSIONS CALCULATED WITH 48" BETWEEN DESK AND CREDENZA



| ITEMS  | ITEM DESCRIPTION   | LIST                 |
|--|--|----------------------|
| <b>LAYOUT #11</b>  |  |                      |
| WRK-7124WCTBKLF20-L  | WARDROBE CABINET/TURNED BOOKCASE OVER LATERAL FILES                      | <b>\$2,367</b>       |
| WRK-2060WS   | 20" DEEP WORK SURFACE TOP  | <b>\$287</b>         |
| WRK-2030UFLX   | BOX/BOX/FILE LATERAL FILE COMBO UNITS - HANDLES LEFT - 20" DEEP - NO TOP | <b>\$1,255</b>       |
| WRK-1620ESG-R  | END SUPPORT GABLE - RIGHT  | <b>\$142</b>         |
| WRK-3072WS   | 30" DEEP WORK SURFACE  | <b>\$437</b>         |
| WRK-1630SG-L   | STORAGE GABLE - LEFT   | <b>\$475</b>         |
| WRK-2140FMP  | FIXED 3/4 HEIGHT MODESTY PANEL   | <b>\$222</b>         |
| WRK-1630FPUFX-R  | FREESTANDING PEDESTAL - HANDLES RIGHT                                    | <b>\$863</b>         |
|  |  | <b>TOTAL \$6,048</b> |
| <i>*NOTE: DIMENSIONS CALCULATED WITH 48" BETWEEN DESK AND CREDENZA</i> |  |                      |

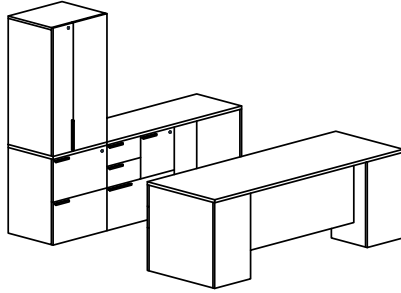

TOTAL DIMENSIONS: 82.75" x 97.25"  
 TOTAL WEIGHT: 556.78 lb / 253.23 kg  
 TOTAL CUBES: 49.013 ft<sup>3</sup> / 1.359 m<sup>3</sup>

|  |  |                                |
|--|--|--------------------------------|
| <b>LAYOUT #12</b>  |  |                                |
| WRK-7124WCSLF20-L -AGD   | WARDROBE CABINET/STORAGE OVER LATERAL FILES<br>W/ AGD DOORS              | <b>\$2,205</b><br><b>\$826</b> |
| WRK-2060WS   | 20" DEEP WORK SURFACE TOP  | <b>\$287</b>                   |
| WRK-2030UFLX   | BOX/BOX/FILE LATERAL FILE COMBO UNITS - HANDLES LEFT - 20" DEEP - NO TOP | <b>\$1,255</b>                 |
| WRK-1620ESG-R  | END SUPPORT GABLE - RIGHT  | <b>\$142</b>                   |
| WRK-3672WS   | 36" DEEP WORK SURFACE  | <b>\$615</b>                   |
| WRK-1630SG-L   | STORAGE GABLE - LEFT   | <b>\$475</b>                   |
| WRK-2140AGM  | ALUMINUM GLAZED FIXED 3/4 HEIGHT MODESTY PANEL                           | <b>\$742</b>                   |
| WRK-1630FPUFX-R  | FREESTANDING PEDESTAL - HANDLES RIGHT                                    | <b>\$863</b>                   |
|  |  | <b>TOTAL \$7,410</b>           |
| <i>*NOTE: DIMENSIONS CALCULATED WITH 48" BETWEEN DESK AND CREDENZA</i> |  |                                |

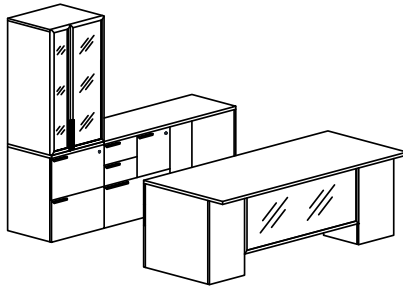

TOTAL DIMENSIONS: 82.75" x 103.25"  
 TOTAL WEIGHT: 578.45 lb / 263.03 kg  
 TOTAL CUBES: 49.283 ft<sup>3</sup> / 1.366 m<sup>3</sup>

|                        |  |                                |
|------------------------|--|--------------------------------|
| <b>LAYOUT #13</b>      |  |                                |
| WRK-7124WCSLF20-L -AGD | WARDROBE CABINET/STORAGE OVER LATERAL FILES<br>W/ AGD DOORS              | <b>\$2,205</b><br><b>\$826</b> |
| WRK-2072WS             | 20" DEEP WORK SURFACE TOP  | <b>\$322</b>                   |
| WRK-2030UFLX           | BOX/BOX/FILE LATERAL FILE COMBO UNITS - HANDLES LEFT - 20" DEEP - NO TOP | <b>\$1,255</b>                 |
| WRK-1620ESG-R          | END SUPPORT GABLE - RIGHT  | <b>\$142</b>                   |
| WRK-2872MHHD-AGD       | HUTCHES W/ METAL SUPPORTS & HINGED DOORS (AGD DOORS)                     | <b>\$1,473</b><br><b>\$834</b> |
| WRK-2042WS             | 20" DEEP WORK SURFACE TOP  | <b>\$215</b>                   |
| WRK-WFBK               | WORK SURFACE FLUSH BRACKET KIT   | 2 X <b>\$36</b>                |
| WRK-3672WS             | 36" DEEP WORK SURFACE  | <b>\$615</b>                   |
| WRK-1630SG-L           | STORAGE GABLE - LEFT   | <b>\$475</b>                   |
| WRK-2140AGM            | ALUMINUM GLAZED FIXED 3/4 HEIGHT MODESTY PANEL                           | <b>\$742</b>                   |
| WRK-1630FPUFX-R        | FREESTANDING PEDESTAL - HANDLES RIGHT                                    | <b>\$863</b>                   |
|                        |  | <b>TOTAL \$10,039</b>          |

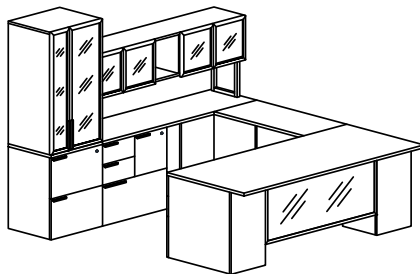

TOTAL DIMENSIONS: 94.5" x 96.5"  
 TOTAL WEIGHT: 692.58 lb / 314.86 kg  
 TOTAL CUBES: 52.828 ft<sup>3</sup> / 1.4711 m<sup>3</sup>

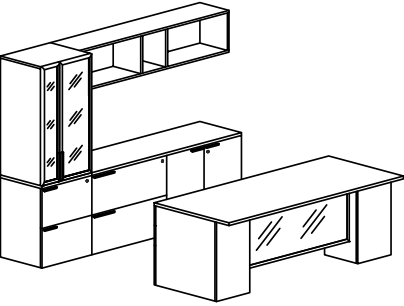
|   | ITEMS                 | ITEM DESCRIPTION   | LIST             |
|---|-----------------------|--|------------------|
|  <p>TOTAL DIMENSIONS: 94.75" x 103.25"<br/>TOTAL WEIGHT: 768.31 lb / 349.9 kg<br/>TOTAL CUBES: 74.34 ft<sup>3</sup> / 2.098 m<sup>3</sup></p> | <b>LAYOUT #14</b>     |  |                  |
|   | WRK-7124WCSLF20-L-AGD | WARDROBE CABINET/STORAGE OVER LATERAL FILES W/ AGD DOORS | \$2,205<br>\$826 |
|   | WRK-LF2072C           | 29" HIGH LATERAL FILE/CABINET CREDENZA                   | \$2,114          |
|   | WRK-1572OS            | OPEN OVERHEAD STORAGE                                    | \$833            |
|   | WRK-3672WS            | 36" DEEP WORK SURFACE                                    | \$615            |
|   | WRK-1630FPUFX-L       | FREESTANDING PEDESTAL - HANDLES LEFT                     | \$863            |
|   | WRK-2140AGM           | ALUMINUM GLAZED FIXED 3/4 HEIGHT MODESTY PANEL           | \$742            |
|   | WRK-1630FPUFX-R       | FREESTANDING PEDESTAL - HANDLES RIGHT                    | \$863            |
|   |                       | <b>TOTAL</b>   | <b>\$9,061</b>   |

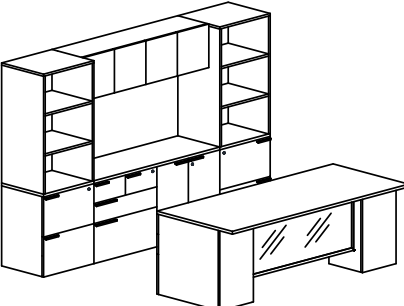
|  |                                       |  |                 |
|--|---------------------------------------|--|-----------------|
|  <p>TOTAL DIMENSIONS: 107" x 103.25"<br/>TOTAL WEIGHT: 942.31 lb / 428.26 kg<br/>TOTAL CUBES: 93.34 ft<sup>3</sup> / 2.618 m<sup>3</sup></p> | <b>LAYOUT #15</b>                     |  |                 |
|  | WRK-7124BKLF20-R                      | BOOKCASE OVER LATERAL FILES - HANDLES RIGHT                  | \$2,049         |
|  | WRK-BBWDLF2060C                       | 29" HIGH BOX/BOX/WIDE DRAWER/LATERAL FILE, CABINET CREDENZAS | \$2,177         |
|  | WRK-7124BKLF20-L                      | BOOKCASE OVER LATERAL FILES - HANDLES LEFT                   | \$2,049         |
|  | WRK-1560OSHD                          | OVERHEAD STORAGE W/ HINGED DOORS                             | \$1,079         |
|  | WRK-3672WS                            | 36" DEEP WORK SURFACE  | \$615           |
|  | WRK-1630FPUFX-L                       | FREESTANDING PEDESTAL - HANDLES LEFT                         | \$863           |
|  | WRK-2140AGM                           | ALUMINUM GLAZED FIXED 3/4 HEIGHT MODESTY PANEL               | \$742           |
| WRK-1630FPUFX-R  | FREESTANDING PEDESTAL - HANDLES RIGHT | \$863  |                 |
|  |                                       | <b>TOTAL</b>   | <b>\$10,437</b> |

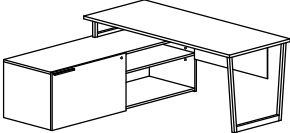
|   |                   |  |                |
|---|-------------------|--|----------------|
|  <p>TOTAL DIMENSIONS: 71" x 71"<br/>TOTAL WEIGHT: 290.69 lb / 131.6 kg<br/>TOTAL CUBES: 30.32 ft<sup>3</sup> / .8547 m<sup>3</sup></p> | <b>LAYOUT #16</b> |  |                |
|   | WRK-SDC2472CO-21  | 21" HIGH SLIDING DOOR CREDENZA - HANDLE LEFT | \$1,632        |
|   | WRK-3072WS        | 30" DEEP WORK SURFACE TOP                    | \$437          |
|   | 100-WSB-64        | WORK SURFACE STIFFENER BAR                   | \$82           |
|   | WRK-30MWR         | METAL 7" - WORKSURFACE RISER                 | \$195          |
|   | WRK-30MVLEG       | METAL V-LEG                                  | \$250          |
|   | WRK-1436PMPS      | PLEXI 1/2 HEIGHT MODESTY PANEL - SUSPENDED   | \$299          |
|   |                   | <b>TOTAL</b>                                 | <b>\$2,895</b> |

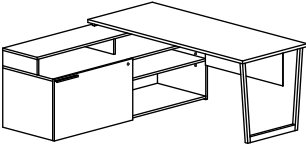
|   |  |  |                |
|---|--|--|----------------|
|  <p>TOTAL DIMENSIONS: 71" x 71"<br/>TOTAL WEIGHT: 325.69 lb / 147.6 kg<br/>TOTAL CUBES: 33.32 ft<sup>3</sup> / .9547 m<sup>3</sup></p> | <b>LAYOUT #17</b>                          |  |                |
|   | WRK-SDC2472CO-21                           | 21" HIGH SLIDING DOOR CREDENZA - HANDLE LEFT | \$1,632        |
|   | WRK-1672DTC                                | DESKTOP CUBBIES                              | \$370          |
|   | WRK-3072WS                                 | 30" DEEP WORK SURFACE TOP                    | \$437          |
|   | 100-WSB-64                                 | WORK SURFACE STIFFENER BAR                   | \$82           |
|   | WRK-30MWS                                  | METAL 1" - WORK SURFACE SPACER               | \$143          |
|   | WRK-30MVLEG                                | METAL V-LEG                                  | \$250          |
| WRK-1436PMPS  | PLEXI 1/2 HEIGHT MODESTY PANEL - SUSPENDED | \$299  |                |
|   |  | <b>TOTAL</b>                                 | <b>\$3,213</b> |

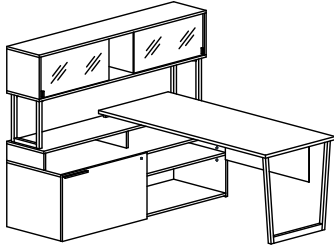

TOTAL DIMENSIONS: 71" x 71"  
TOTAL WEIGHT: 405.69 lb / 184 kg  
TOTAL CUBES: 36.32 ft<sup>3</sup> / 1.0447 m<sup>3</sup>

| ITEMS             | ITEM DESCRIPTION   | LIST           |
|-------------------|--|----------------|
| <b>LAYOUT #18</b> |  |                |
| WRK-SDC2472CO-21  | 21" HIGH SLIDING DOOR CREDENZA - HANDLE LEFT             | \$1,632        |
| WRK-1672DTC       | DESKTOP CUBBIES  | \$370          |
| WRK-3072MHBD      | 30" HIGH HUTCH WITH METAL SUPPORTS & PLEXI BI-PASS DOORS | \$1,821        |
| WRK-3072WS        | 30" DEEP WORK SURFACE TOP                                | \$437          |
| 100-WSB-64        | WORK SURFACE STIFFENER BAR                               | \$82           |
| WRK-30MWS         | METAL 1" - WORK SURFACE SPACER                           | \$143          |
| WRK-30MVLEG       | METAL V-LEG  | \$250          |
| WRK-1436PMPS      | PLEXI 1/2 HEIGHT MODESTY PANEL - SUSPENDED               | \$299          |
| <b>TOTAL</b>      |  | <b>\$5,034</b> |

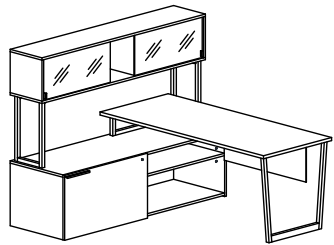

TOTAL DIMENSIONS: 71" x 71"  
TOTAL WEIGHT: 370.69 lb / 168 kg  
TOTAL CUBES: 33.32 ft<sup>3</sup> / .9447 m<sup>3</sup>

|                   |  |                |
|-------------------|--|----------------|
| <b>LAYOUT #19</b> |  |                |
| WRK-SDC2472CO-21  | 21" HIGH SLIDING DOOR CREDENZA - HANDLE LEFT             | \$1,632        |
| WRK-3672MHBD      | 36" HIGH HUTCH WITH METAL SUPPORTS & PLEXI BI-PASS DOORS | \$1,924        |
| WRK-3072WS        | 30" DEEP WORK SURFACE TOP                                | \$437          |
| 100-WSB-64        | WORK SURFACE STIFFENER BAR                               | \$82           |
| WRK-30MWR         | METAL 7" - WORKSURFACE RISER                             | \$195          |
| WRK-30MVLEG       | METAL V-LEG  | \$250          |
| WRK-1436PMPS      | PLEXI 1/2 HEIGHT MODESTY PANEL - SUSPENDED               | \$299          |
| <b>TOTAL</b>      |  | <b>\$4,819</b> |

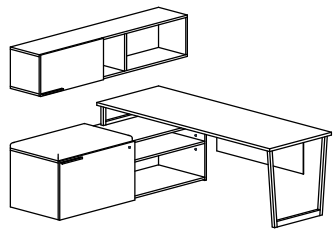

TOTAL DIMENSIONS: 71" x 71"  
TOTAL WEIGHT: 376.98 lb / 170.8 kg  
TOTAL CUBES: 35.33 ft<sup>3</sup> / 1.0147 m<sup>3</sup>

|                   |  |                |
|-------------------|--|----------------|
| <b>LAYOUT #20</b> |  |                |
| WRK-SDC2472CO-21  | 21" HIGH SLIDING DOOR CREDENZA - HANDLE LEFT     | \$1,632        |
| WRK-2436CUSH-ESC  | CREDENZA SEAT CUSHION- REF PG WRK-10 FOR OPTIONS | \$525          |
| WRK-1572OSSD-L    | OVERHEAD STORAGE WITH SLIDING DOOR - HANDLE LEFT | \$1,202        |
| WRK-3072WS        | 30" DEEP WORK SURFACE TOP                        | \$437          |
| 100-WSB-64        | WORK SURFACE STIFFENER BAR                       | \$82           |
| WRK-30MWR         | METAL 7" - WORKSURFACE RISER                     | \$195          |
| WRK-30MVLEG       | METAL V-LEG                                      | \$250          |
| WRK-1442PMPS      | PLEXI 1/2 HEIGHT MODESTY PANEL - SUSPENDED       | \$332          |
| <b>TOTAL</b>      |  | <b>\$4,655</b> |

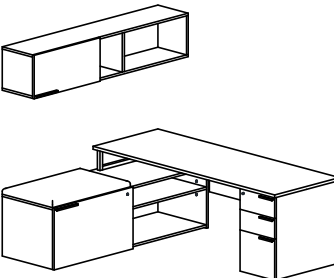

TOTAL DIMENSIONS: 71" x 71"  
TOTAL WEIGHT: 449.34 lb / 203.55 kg  
TOTAL CUBES: 41.68 ft<sup>3</sup> / 1.1933 m<sup>3</sup>

|                   |  |                |
|-------------------|--|----------------|
| <b>LAYOUT #21</b> |  |                |
| WRK-SDC2472CO-21  | 21" HIGH SLIDING DOOR CREDENZA - HANDLE LEFT     | \$1,632        |
| WRK-2436CUSH-ESC  | CREDENZA SEAT CUSHION- REF PG WRK-10 FOR OPTIONS | \$525          |
| WRK-1572OSSD-L    | OVERHEAD STORAGE WITH SLIDING DOOR - HANDLE LEFT | \$1,202        |
| WRK-3072WS        | 30" DEEP WORK SURFACE TOP                        | \$437          |
| 100-WSB-52        | WORK SURFACE STIFFENER BAR                       | \$82           |
| WRK-30MWR         | METAL 7" - WORKSURFACE RISER                     | \$195          |
| WRK-1430PMPS      | PLEXI 1/2 HEIGHT MODESTY PANEL - SUSPENDED       | \$260          |
| WRK-1630PFUFX-R   | FREESTANDING PEDESTALS - HANDLES RIGHT           | \$863          |
| <b>TOTAL</b>      |  | <b>\$5,196</b> |

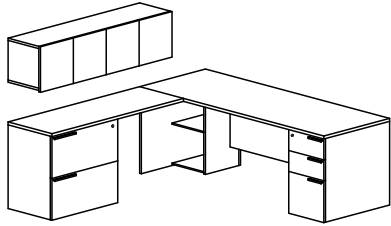

TOTAL DIMENSIONS: 89" x 71"  
TOTAL WEIGHT: 416.24 lb / 189.3 kg  
TOTAL CUBES: 27.389 ft<sup>3</sup> / .7521 m<sup>3</sup>

| ITEMS             | ITEM DESCRIPTION                                | LIST           |
|-------------------|---|----------------|
| <b>LAYOUT #22</b> |   |                |
| WRK-2030LFX-L     | LATERAL FILE - HANDLES LEFT - 20" DEEP - NO TOP | \$1,002        |
| WRK-2060WS        | 20" DEEP WORK SURFACE                           | \$287          |
| WRK-WFBK          | WORK SURFACE FLUSH BRACKET KIT                  | \$36           |
| WRK-1630SG-L      | STORAGE GABLE - LEFT                            | \$475          |
| WRK-1560OSHD      | OVERHEAD STORAGE W/ HINGED DOORS                | \$1,079        |
| WRK-3072WS        | 30" DEEP WORK SURFACE                           | \$437          |
| WRK-2140FMP       | LAMINATE 3/4 HEIGHT MODESTY PANEL - FIXED       | \$222          |
| WRK-1630FPUFX-R   | FREESTANDING PEDESTALS - HANDLES RIGHT          | \$863          |
| <b>TOTAL</b>      |   | <b>\$4,401</b> |

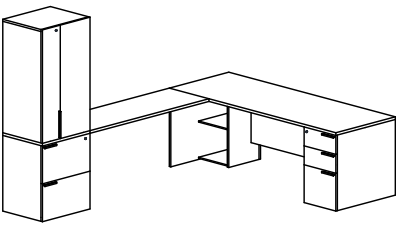

TOTAL DIMENSIONS: 112.75" x 71"  
TOTAL WEIGHT: 445.74 lb / 202.43 kg  
TOTAL CUBES: 35.394 ft<sup>3</sup> / .9922 m<sup>3</sup>

|                     |   |                |
|---------------------|---|----------------|
| <b>LAYOUT #23</b>   |   |                |
| WRK-7124WCTBKLF20-L | WARDROBE CABINET/TURNED BOOKCASE OVER LATERAL FILES | \$2,367        |
| WRK-2060WS          | 20" DEEP WORK SURFACE                               | \$287          |
| 100-WSB-52          | WORK SURFACE STIFFENER BAR                          | \$82           |
| WRK-WFBK            | WORK SURFACE FLUSH BRACKET KIT                      | \$36           |
| WRK-20MVLEG         | METAL V-LEG   | \$195          |
| WRK-1630SG-L        | STORAGE GABLE - LEFT                                | \$475          |
| WRK-3072WS          | 30" DEEP WORK SURFACE                               | \$437          |
| WRK-2140FMP         | LAMINATE 3/4 HEIGHT MODESTY PANEL - FIXED           | \$222          |
| WRK-1630FPUFX-R     | FREESTANDING PEDESTALS - HANDLES RIGHT              | \$863          |
| <b>TOTAL</b>        |   | <b>\$4,964</b> |

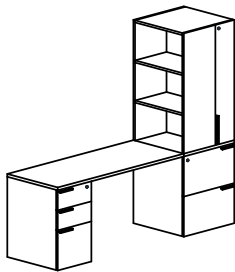

TOTAL DIMENSIONS: 82.75" x 19.75"  
TOTAL WEIGHT: 308.38 lb / 140.33 kg  
TOTAL CUBES: 29.845 ft<sup>3</sup> / .8341 m<sup>3</sup>

|                     |   |                |
|---------------------|---|----------------|
| <b>LAYOUT #24</b>   |   |                |
| WRK-1620FPUFX-L     | FREESTANDING PEDESTALS - HANDLES LEFT               | \$837          |
| WRK-2060WS          | 20" DEEP WORK SURFACE                               | \$287          |
| 100-WSB-40          | WORK SURFACE STIFFENER BAR                          | \$82           |
| WRK-WABK            | WORK SURFACE ANGLE BRACKET KIT                      | \$40           |
| WRK-7124TBKWCFL20-R | TURNED BOOKCASE/WARDROBE CABINET OVER LATERAL FILES | \$2,367        |
| <b>TOTAL</b>        |   | <b>\$3,613</b> |

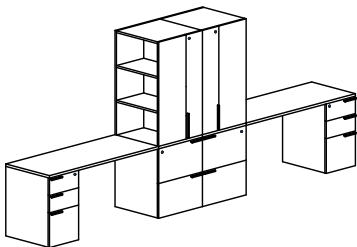

TOTAL DIMENSIONS: 166.5" x 19.75"  
TOTAL WEIGHT: 616.76 lb / 280.66 kg  
TOTAL CUBES: 59.69 ft<sup>3</sup> / 1.6682 m<sup>3</sup>

|                     |   |                |
|---------------------|---|----------------|
| <b>LAYOUT #25</b>   |   |                |
| WRK-1620FPUFX-R     | FREESTANDING PEDESTALS - HANDLES RIGHT              | \$837          |
| WRK-2060WS          | 20" DEEP WORK SURFACE                               | 2 X \$287      |
| 100-WSB-40          | WORK SURFACE STIFFENER BAR                          | 2 X \$82       |
| WRK-WABK            | WORK SURFACE ANGLE BRACKET KIT                      | 2 X \$40       |
| WRK-7124TBKWCFL20-R | TURNED BOOKCASE/WARDROBE CABINET OVER LATERAL FILES | \$2,367        |
| WRK-7124WCTBKLF20-L | WARDROBE CABINET/TURNED BOOKCASE OVER LATERAL FILES | \$2,367        |
| WRK-1620FPUFX-L     | FREESTANDING PEDESTALS - HANDLES LEFT               | \$837          |
| <b>TOTAL</b>        |   | <b>\$7,226</b> |

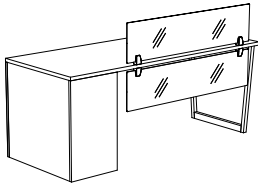

TOTAL DIMENSIONS: 71" x 29.5"  
TOTAL WEIGHT: 129.8 lb / 59 kg  
TOTAL CUBES: 4.184 ft<sup>3</sup> / .378 m<sup>3</sup>

| ITEMS             | ITEM DESCRIPTION                         | LIST           |
|-------------------|--|----------------|
| <b>LAYOUT #26</b> |  |                |
| WRK-30MVLEG       | METAL V-LEG                              | \$250          |
| WRK-3072WS        | 30" DEEP WORK SURFACE TOP                | \$437          |
| 100-WSB-52        | WORK SURFACE STIFFENER BAR               | \$82           |
| WRK-1630BKX       | OPEN BOOKCASE - NO TOP W/ 1 FIXED SHELF  | \$636          |
| WRK-1448PMPS      | PLEXI ½ HEIGHT MODESTY PANEL - SUSPENDED | \$411          |
| WRK-1248PDP       | PLEXI DIVIDER PANEL                      | \$411          |
| <b>TOTAL</b>      |  | <b>\$2,227</b> |

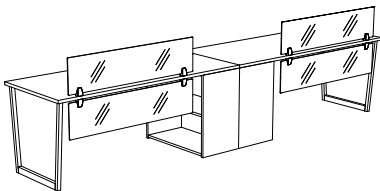

TOTAL DIMENSIONS: 142" x 29.5"  
TOTAL WEIGHT: 259.6 lb / 118 kg  
TOTAL CUBES: 8.368 ft<sup>3</sup> / .756 m<sup>3</sup>

|                   |  |                |
|-------------------|--|----------------|
| <b>LAYOUT #27</b> |  |                |
| WRK-30MVLEG       | METAL V-LEG                              | 2 X \$250      |
| WRK-3072WS        | 30" DEEP WORK SURFACE TOP                | 2 X \$437      |
| 100-WSB-52        | WORK SURFACE STIFFENER BAR               | 2 X \$82       |
| WRK-1630BKX       | OPEN BOOKCASE - NO TOP W/ 1 FIXED SHELF  | 2 X \$636      |
| WRK-1248PDP       | PLEXI DIVIDER PANEL                      | 2 X \$411      |
| WRK-1448PMPS      | PLEXI ½ HEIGHT MODESTY PANEL - SUSPENDED | 2 X \$411      |
| <b>TOTAL</b>      |  | <b>\$4,454</b> |

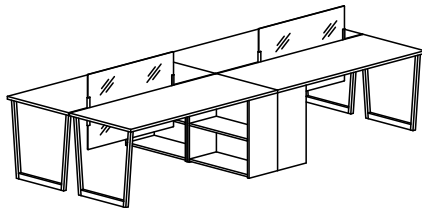

TOTAL DIMENSIONS: 142" x 59.5"  
TOTAL WEIGHT: 487.78 lb / 222 kg  
TOTAL CUBES: 16.276 ft<sup>3</sup> / 1.498 m<sup>3</sup>

|                   |   |                |
|-------------------|---|----------------|
| <b>LAYOUT #28</b> |   |                |
| WRK-30MVLEG       | METAL V-LEG                             | 4 X \$250      |
| WRK-3072WS        | 30" DEEP WORK SURFACE TOP               | 4 X \$437      |
| 100-WSB-52        | WORK SURFACE STIFFENER BAR              | 4 X \$82       |
| WRK-1630BKX       | OPEN BOOKCASE - NO TOP W/ 1 FIXED SHELF | 4 X \$636      |
| WRK-2836PMPDS     | PLEXI MODESTY PANEL/DIVIDER - SUSPENDED | 2 X \$477      |
| <b>TOTAL</b>      |   | <b>\$6,574</b> |

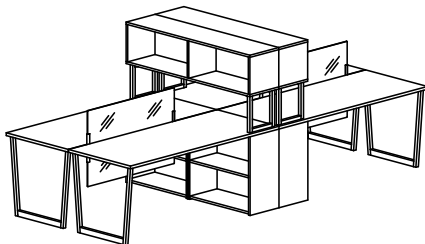

TOTAL DIMENSIONS: 142" x 59.5"  
TOTAL WEIGHT: 621.78 lb / 283 kg  
TOTAL CUBES: 621.78 lb / 283 kg

|                   |   |                |
|-------------------|---|----------------|
| <b>LAYOUT #29</b> |   |                |
| WRK-30MVLEG       | METAL V-LEG                             | 4 X \$250      |
| WRK-3072WS        | 30" DEEP WORK SURFACE TOP               | 4 X \$437      |
| 100-WSB-52        | WORK SURFACE STIFFENER BAR              | 4 X \$82       |
| WRK-1630BKX       | OPEN BOOKCASE - NO TOP W/ 1 FIXED SHELF | 4 X \$636      |
| WRK-2836PMPDS     | PLEXI MODESTY PANEL/DIVIDER - SUSPENDED | 2 X \$477      |
| WRK-2860MH        | OPEN HUTCHES W/ METAL SUPPORTS          | 2 X \$716      |
| <b>TOTAL</b>      |   | <b>\$8,006</b> |

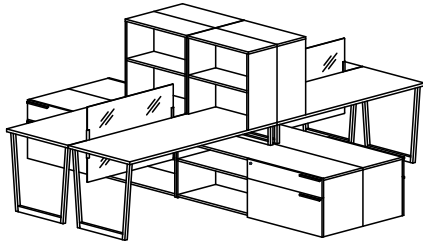

TOTAL DIMENSIONS: 142" x 142"  
TOTAL WEIGHT: 1325.46 lb / 602 kg  
TOTAL CUBES: 109.26 ft<sup>3</sup> / 3.0968 m<sup>3</sup>

| ITEMS             | ITEM DESCRIPTION                                       | LIST |                       |
|-------------------|--|------|-----------------------|
| <b>LAYOUT #30</b> |  |      |                       |
| WRK-30MVLEG       | METAL V-LEG  | 4 X  | \$250                 |
| WRK-3072WS        | 30" DEEP WORK SURFACE TOP                              | 4 X  | \$437                 |
| WRK-30MWR         | METAL 7" WORK SURFACE RISER                            | 4 X  | \$195                 |
| 100-WSB-64        | WORK SURFACE STIFFENER BAR                             | 4 X  | \$82                  |
| WRK-WDLF2072CO-21 | 21" HIGH WIDE DRAWER/LATERAL FILE, OPEN SHELF CREDENZA | 2 X  | \$1,472               |
| WRK-CO2072WDLF-21 | 21" HIGH OPEN SHELF, WIDE DRAWER/LATERAL FILE CREDENZA | 2 X  | \$1,472               |
| WRK-2836PMPDS     | PLEXI MODESTY PANEL/DIVIDER - SUSPENDED                | 2 X  | \$477                 |
| WRK-2830WEH       | OPEN WORK SURFACE END HUTCH                            | 4 X  | \$559                 |
|                   |  |      | <b>TOTAL \$12,934</b> |

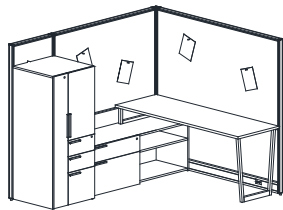

TOTAL DIMENSIONS: 84" x 72"  
TOTAL WEIGHT: 677.2 lb / 307.6 kg  
TOTAL CUBES: 61.4 ft<sup>3</sup> / 1.76 m<sup>3</sup>

| <b>LAYOUT #31- WORKSCAPE W/ HDL FRAMEWORK FREESTANDING PANELS</b> |  |     |   |
|---|--|-----|---|
| <b>WORKSCAPE COMPONENTS</b>                                       |  |     |   |
| WRK-5724CUFWL-24  | CLOSET STORAGE   | 1 X | \$2,196                                   |
| WRK-WDLF2060CO-21   | 21" HIGH WIDE DRAWER/LATERAL FILE, OPEN SHELF CREDENZA | 1 X | \$1,347                                   |
| WRK-2472WS  | 24" DEEP WORKSURFACE TOP                               | 1 X | \$392                                     |
| 100-WSB-64  | WORK SURFACE STIFFENER BAR                             | 1 X | \$82                                      |
| WRK-24MWR   | METAL 7" WORK SURFACE RISER                            | 1 X | \$172                                     |
| WRK-24MVLEG   | METAL V-LEG  | 1 X | \$219                                     |
|   |  |     | <b>WORKSCAPE COMPONENTS ONLY= \$4,408</b> |
| <b>HDL FRAMEWORK PANEL SYSTEM COMPONENTS*</b>                     |  |     |   |
| FRM-6066P   | 66" TALL PANEL   | 1 X | \$872                                     |
| FRM-2466P   | 66" TALL PANEL   | 1 X | \$457                                     |
| FRM-7266P   | 66" TALL PANEL   | 1 X | \$1105                                    |
| FRM-66SQP-2W  | SQUARE 2 WAY CONNECTING POST                           | 1 X | \$109                                     |
| FRM-66PET   | PANEL END TRIM   | 2 X | \$32                                      |
| FRM-PCK   | PANEL CONNECTING KIT                                   | 1 X | \$40                                      |
|   |  |     | <b>PANEL COMPONENTS ONLY= \$2,647</b>     |
|   |  |     | <b>TOTAL \$7,055</b>                      |

\*FRAMEWORK FREESTANDING PANELS CAN BE ORDERED THROUGH HDL. FOR MORE INFORMATION VISIT ONLINE AT [WWW.HEARTWOODDL.COM](http://WWW.HEARTWOODDL.COM)

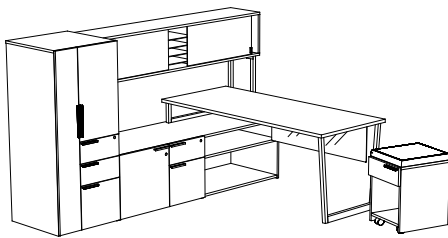

TOTAL DIMENSIONS: 94.75" x 23.75"  
TOTAL WEIGHT: 717 lbs / 325.2 kgs  
TOTAL CUBES: 81.12 ft<sup>3</sup> / 1.56 m<sup>3</sup>

| <b>LAYOUT #32</b> |   |     |                      |
|-------------------|---|-----|----------------------|
| WRK-5724CUFWL-24  | CLOSET STORAGE                                  | 1 X | \$2,196              |
| WRK-3672MHBD-COL  | PLEXI BI-PASS DOORS                             | 1 X | \$1,924              |
|                   | <i>OPTIONAL PLEXIGLASS COLLATOR</i>             | 1 X | \$369                |
| WRK-CF2472CO-21   | 21" HIGH CABINET/BOX/FILE, OPEN SHELF CREDENZAS | 1 X | \$1,892              |
| WRK-30MVLEG       | METAL V-LEG                                     | 1 X | \$250                |
| WRK-30MWR         | METAL 7" WORK SURFACE RISER                     | 1 X | \$195                |
| WRK-3072WS        | 30" WORK SURFACE                                | 1 X | \$437                |
| WRK-MPEDCUSH-ESC  | PEDESTAL CUSHION                                | 1 X | \$393                |
| WRK-1621MPBO-L    | 21" MOBILE PEDESTAL                             | 1 X | \$674                |
| WRK-1442PMPDS     | PLEXI ½ HEIGHT MODESTY PANELS - SUSPENDED       | 1 X | \$332                |
| 100-WSB-64        | 64" STIFFENER BAR                               | 1 X | \$82                 |
|                   |   |     | <b>TOTAL \$8,744</b> |

| ITEMS | ITEM DESCRIPTION | LIST |
|-------|------------------|------|
|-------|------------------|------|

**LAYOUT #33**

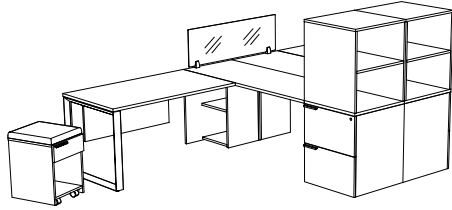

TOTAL DIMENSIONS: 154" X 88.75"  
 TOTAL WEIGHT: 847.7 lbs / 384.4 kgs  
 TOTAL CUBES: 67.49 ft<sup>3</sup> / 1.9 m<sup>3</sup>

|                   |  |                 |
|-------------------|--|-----------------|
| 900-LOOP30        | 30" METAL LOOP LEG                             | 2 X \$207       |
| WRK-3054WS        | 30" WORK SURFACE                               | 2 X \$337       |
| WRK-2466WS        | 24" WORK SURFACE                               | 2 X \$367       |
| WRK-1624SG-L      | STORAGE GABLE W/ 1 FIXED SHELF                 | 1 X \$449       |
| WRK-1624SG-R      | STORAGE GABLE W/ 1 FIXED SHELF                 | 1 X \$449       |
| WRK-5724TBKLF24-L | BOOKCASE OVER LATERAL FILES- 57" TALL          | 1 X \$2,049     |
| WRK-5724TBKLF24-R | BOOKCASE OVER LATERAL FILES- 57" TALL          | 1 X \$2,049     |
| WRK-1621MPBO-L    | 21" MOBILE PEDESTAL                            | 2 X \$674       |
| WRK-MPEDCUSH-ESC  | PEDESTAL CUSHION                               | 2 X \$393       |
| TM1-1548PLX       | 15" TOP MOUNT PLEXIGLASS PRIVACY PANEL         | 1 X \$477       |
| WRK-1442LMPS      | LAMINATE 1/2 HEIGHT MODESTY PANELS - SUSPENDED | 2 X \$215       |
| WRK-WABK          | WORK SURFACE ANGLE BRACKET KIT                 | 2 X \$40        |
| WRK-WFBK          | WORK SURFACE FLUSH BRACKET KIT                 | 2 X \$36        |
| 100-WSB-46        | 46" STIFFENER BAR                              | 4 X \$82        |
| <b>TOTAL</b>      |  | <b>\$10,339</b> |

**LAYOUT #34**

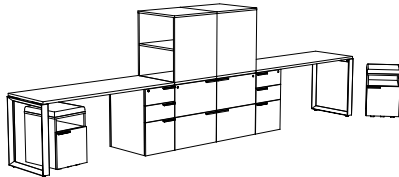

TOTAL DIMENSIONS: 177.5" X 23.75"  
 TOTAL WEIGHT: 816.8lbs / 370.43 kgs  
 TOTAL CUBES: 77.68 ft<sup>3</sup> / 2.056 m<sup>3</sup>

|                   |  |                |
|-------------------|--|----------------|
| 900-LOOP24        | 24" METAL LOOP LEG                         | 2 X \$188      |
| WRK-1624FPUFX-L   | FREESTANDING BOX/BOX/FILE, NO TOP PEDESTAL | 1 X \$851      |
| WRK-1624FPUFX-R   | FREESTANDING BOX/BOX/FILE, NO TOP PEDESTAL | 1 X \$851      |
| WRK-2466WS        | 24" WORK SURFACE                           | 2 X \$367      |
| WRK-5724TBKLF24-L | BOOKCASE OVER LATERAL FILES- 57" TALL      | 1 X \$2,049    |
| WRK-5724TBKLF24-R | BOOKCASE OVER LATERAL FILES- 57" TALL      | 1 X \$2,049    |
| WRK-1621MPOF-L    | 21" MOBILE PEDESTAL                        | 2 X \$696      |
| WRK-MPEDCUSH-ESC  | PEDESTAL CUSHION                           | 2 X \$393      |
| 100-WSB-46        | 46" STIFFENER BAR                          | 2 X \$82       |
| <b>TOTAL</b>      |  | <b>\$9,252</b> |

**LAYOUT #35**

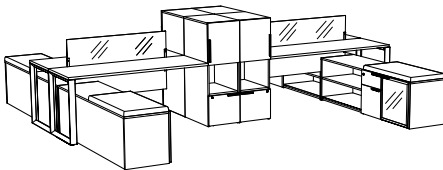

TOTAL DIMENSIONS: 1161.5" x 142"  
 TOTAL WEIGHT: 1462 lbs / 663.03 kgs  
 TOTAL CUBES: 143.9 ft<sup>3</sup> / 4.1 m<sup>3</sup>

|                     |  |                 |
|---------------------|--|-----------------|
| WRK-CO2072FC-21-AGD | 21" HIGH OPEN SHELF, BOX/ FILE/CABINET CREDENZAS | 2 X \$1,827     |
|                     | <i>AGD UP-CHARGE</i>                             | 2 X \$276       |
| WRK-CF2072CO-21-AGD | 21" HIGH CABINET/BOX/FILE, OPEN SHELF CREDENZAS  | 2 X \$1,827     |
|                     | <i>AGD UP-CHARGE</i>                             | 2 X \$276       |
| WRK-2036CUSH-ESC    | SEAT CUSHIONS FOR 21" HIGH CREDENZAS             | 4 X \$457       |
| WRK-2466WS          | 24" WORK SURFACE                                 | 4 X \$367       |
| 900-LOOP24          | 24" METAL LOOP LEG                               | 4 X \$188       |
| WRK-WABK            | WORK SURFACE ANGLE BRACKET KIT                   | 4 X \$40        |
| WRK-4716COF24-L     | MID-HEIGHT CABINET/ OPEN/FILE DRAWER CABINET     | 2 X \$897       |
| WRK-4716COF24-R     | MID-HEIGHT CABINET/ OPEN/FILE DRAWER CABINET     | 2 X \$897       |
| WRK-2848PMPDS       | PLEXI MODESTY PANEL/DIVIDER - SUSPENDED          | 2 X \$613       |
| 100-WSB-58          | 58" STIFFENER BAR                                | 4 X \$82        |
| <b>TOTAL</b>        |  | <b>\$17,762</b> |

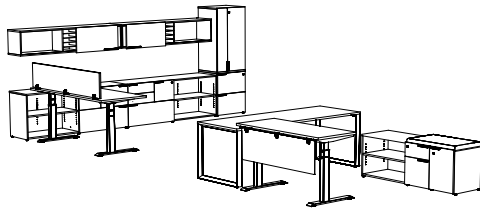

TOTAL WEIGHT: 1419.3 lbs / 643.7 kgs  
TOTAL CUBES: 123.4 ft<sup>3</sup> / 3.5 m<sup>3</sup>

| ITEMS              | ITEM DESCRIPTION   | LIST            |
|--------------------|--|-----------------|
| <b>LAYOUT #36</b>  |  |                 |
| CAL-E1-2LEG        | STRAIGHT ELECTRIC HEIGHT ADJUSTABLE 2 LEG BASE           | X2 \$1,364      |
| CAL-REC3072        | 30" RECTANGLE TOP  | \$453           |
| TM1-1572BTP        | 15" TOP MOUNT TACK BOARD PRIVACY PANEL                   | \$731           |
| WRK-CO2072FUL-27   | 27" HIGH OPEN SHELF, FILE/BOX/BOX/LATERAL FILE CREDENZAS | \$2,119         |
| WRK-UFL2072CO-27   | 27" HIGH BOX/BOX/FILE/LATERAL FILE, OPEN SHELF CREDENZAS | \$2,119         |
| WRK-7124WCSLF20-L  | WARDROBE CABINET/STORAGE OVER LATERAL FILES              | \$2,205         |
| WRK-1572OSSD-L-COL | OVERHEAD STORAGE W/ SLIDING DOOR - HANDLE LEFT           | \$1,202         |
|                    | OPTIONAL PLEXIGLASS COLLATOR                             | \$369           |
| WRK-1572OSSD-R-COL | OVERHEAD STORAGE W/ SLIDING DOOR - HANDLE RIGHT          | \$1,202         |
|                    | OPTIONAL PLEXIGLASS COLLATOR                             | \$369           |
| FLXS-REC3072       | 30" RECTANGLE TOPS                                       | \$437           |
| 900-LOOP30         | 30" METAL LOOP LEG                                       | X2 \$207        |
| CAL-REC2454        | 24" RECTANGLE TOP  | \$363           |
| CAL-MP1648PLX      | 16" PLEXIGLASS HANGING MODESTY PANEL                     | \$428           |
| WRK-CO2060FC-21    | 21" HIGH OPEN SHELF, BOX/ FILE/CABINET CREDENZAS         | \$1,671         |
| WRK-2030CUSH-ESC   | SEAT CUSHIONS FOR 21" HIGH CREDENZAS                     | \$457           |
| <b>TOTAL</b>       |  | <b>\$17,267</b> |

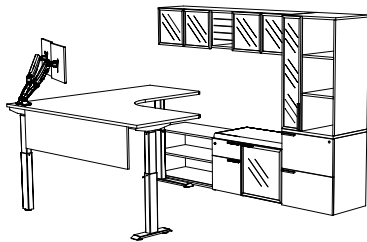

TOTAL DIMENSIONS: 90.75" x 94.75"  
TOTAL WEIGHT: 1001.18 lbs / 419.8kgs  
TOTAL CUBES: 118.9 ft<sup>3</sup> / 3.34 m<sup>3</sup>

|                           |  |                 |
|---------------------------|--|-----------------|
| <b>LAYOUT #37</b>         |  |                 |
| CAL-3072-7230RCMLD        | ONE PIECE L-SHAPED TOP                           | \$1,443         |
| CAL-E1-3LEG               | L SHAPED ELECTRIC HEIGHT ADJUSTABLE 3 LEG BASE   | \$1,988         |
| CAL-MP1866LAP             | 18" LAMINATE MODESTY PANELS                      | \$282           |
| 100-MA2                   | PNEUMATIC LCD DUAL MONITOR ARM                   | \$436           |
| WRK-CO2072FC-21-AGD-FR    | 21" HIGH OPEN SHELF, BOX/ FILE/CABINET CREDENZAS | \$1,827         |
|                           | AGD UP-CHARGE                                    | \$276           |
| WRK-2036CUSH-ESC          | SEAT CUSHIONS FOR 21" HIGH CREDENZAS             | \$457           |
| WRK-1572OSHD-AGD-FR-COL   | OVERHEAD STORAGE W/ HINGED DOORS                 | \$1,216         |
|                           | AGD UP-CHARGE                                    | \$834           |
|                           | OPTIONAL PLEXIGLASS COLLATOR                     | \$369           |
| WRK-7124WCBKLF20-L-AGD-FR | WARDROBE CABINET/BOOKCASE OVER LATERAL FILES     | \$2,309         |
|                           | AGD UP-CHARGE                                    | \$406           |
| <b>TOTAL</b>              |  | <b>\$11,843</b> |



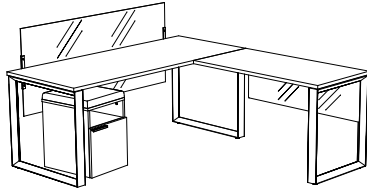

TOTAL DIMENSIONS: 71" x 76.75"  
 TOTAL WEIGHT: 236 lbs / 107.02kgs  
 TOTAL CUBES: 12.4 ft<sup>3</sup> / .41 m<sup>3</sup>

| ITEMS             | ITEM DESCRIPTION                          | LIST            |
|-------------------|---|-----------------|
| <b>LAYOUT #38</b> |   |                 |
| WRK-3072WS        | 30" WORK SURFACE                          | <b>\$437</b>    |
| WRK-2448WS        | 24" WORK SURFACE                          | <b>\$246</b>    |
| WRK-WFBK          | WORK SURFACE FLUSH BRACKET KIT            | <b>\$36</b>     |
| 100-WSB-64        | 64" STIFFENER BAR FOR USE W/ 72" TOPS     | <b>\$82</b>     |
| 900-LOOP24        | 24" METAL LOOP LEG                        | <b>\$188</b>    |
| 900-LOOP30        | 30" METAL LOOP LEG                        | X2 <b>\$207</b> |
| WRK-1621MPOF-L    | 21" MOBILE PEDESTAL                       | <b>\$696</b>    |
| WRK-MPEDCUSH-ESC  | PEDESTAL CUSHION                          | <b>\$393</b>    |
| WRK-1448PMPS      | PLEXI ½ HEIGHT MODESTY PANELS - SUSPENDED | <b>\$332</b>    |
| WRK-2860PMPDS     | PLEXI MODESTY PANEL/DIVIDER - SUSPENDED   | <b>\$741</b>    |
| <b>TOTAL</b>      |   | <b>\$3,565</b>  |



# OUTLINES, OUTLINES *Plus* & PROTECTIVE HEALTH GUARD SERIES

This is a metric series (imperial sizing available). Please refer to page [INDEX-1](#) for details

## OUTLINES SERIES

|   |        |
|---|--------|
| <b>Outlines, Outlines <i>Plus</i>, &amp; Protective Health Guard Overview</b> | OUT-3  |
| <b>Outlines &amp; Outlines <i>Plus</i> Finishes</b>                           | OUT-5  |
| <b>Outlines Features &amp; Specifications</b>                                 | OUT-6  |
| <b>Outlines Panel Configuration Overview</b>                                  | OUT-7  |
| <b>Product by Category</b>  |        |
| <b>Accessories</b>  | OUT-9  |
| <b>Post Packages</b>  | OUT-9  |
| <b>Fillers</b>  | OUT-9  |
| <b>Panels</b>   |        |
| Polycarbonate Panels  | OUT-10 |
| Plexiglass Panels   | OUT-11 |
| Tack-board Panels   | OUT-13 |
| Laminate Panels   | OUT-14 |
| Neo-Angle Corner Panel Sets   | OUT-16 |
| Neo-Angle Wedge Panel Sets  | OUT-17 |
| <b>1" &amp; 1½" Tops</b>  |        |
| Neo-Angle Transaction Tops  | OUT-18 |
| Straight Tops   | OUT-19 |
| Corner Transaction Tops   | OUT-20 |
| Shaped Corner Transaction Tops  | OUT-21 |
| <b>Hutches - 1" &amp; 1½" Tops</b>  |        |
| Open Hutches  | OUT-22 |
| Hutch W/ Hinged Doors   | OUT-23 |
| Hutch w/ Flipper Doors  | OUT-24 |
| Open Corner Hutch   | OUT-25 |
| Corner Hutch w/ Hinged Doors  | OUT-25 |
| Hutch Filler Panels   | OUT-26 |
| <b>Tall Storage Cabinets - 1" &amp; 1½" Tops</b>                              | OUT-27 |
| <b>Layouts</b>  | OUT-30 |

continued...

# OUTLINES *Plus* SERIES

|  |        |
|--|--------|
| <b>Outlines <i>Plus</i> Features &amp; Specifications</b> .....        | OUT-40 |
| <b>Outlines <i>Plus</i> Panel Configuration Overview</b> .....         | OUT-40 |
| <b>Product by Category</b> .....                                       |        |
| <b>Top Mount -1" &amp; 1½" Tops (TM1)</b> .....                        |        |
| Laminate Panels .....  | OUT-42 |
| Plexiglass Panels .....  | OUT-43 |
| Tack-board Panels .....  | OUT-44 |
| Acoustic PET Panels .....  | OUT-46 |
| <b>Edge Mount -1" Tops Only (EM1)</b> .....                            |        |
| Laminate Panels .....  | OUT-48 |
| Plexiglass Panels .....  | OUT-49 |
| Tack-board Panels .....  | OUT-50 |
| Acoustic PET Panels .....  | OUT-51 |
| <b>Surface Mount   Freestanding (FS1)</b> .....                        |        |
| Plexiglass Panels .....  | OUT-53 |
| <b>Panel Mount -Framework Panels or 1" &amp; 1½" Tops (FRM1)</b> ..... |        |
| Plexiglass Panel Extensions .....                                      | OUT-54 |
| <b>Modesty Panel/Divider Suspended (MDS)</b> .....                     |        |
| Laminate Panels .....  | OUT-55 |
| Plexiglass Panels .....  | OUT-55 |
| Tack-board Panels .....  | OUT-56 |
| Acoustic PET Panels .....  | OUT-56 |
| <b>Layouts</b> .....   | OUT-57 |

# PROTECTIVE HEALTH GUARD (PHG) SERIES

|   |        |
|---|--------|
| <b>Product by Category</b> .....                            |        |
| <b>Surface Mounted Health Guard</b> .....                   | OUT-64 |
| <b>Removable Protective Health Guard</b> .....              | OUT-65 |
| <b>Freestanding Protective Health Guard</b> .....           | OUT-66 |
| <b>Desk Divider Panel with Plexiglass Top</b> .....         | OUT-67 |
| <b>Freestanding Divider Panel with Plexiglass Top</b> ..... | OUT-68 |
| <b>Glass Panel Extensions (FRM1)</b> .....                  | OUT-70 |
| <b>Layouts</b> .....  | OUT-71 |

**Outlines & Outlines *Plus* Descriptions**

Our popular OUTLINES Series now has even more options available for those looking for the privacy and the workspace division created by privacy panels. OUTLINES *Plus*, Heartwood Manufacturing's newest line of desktop-mounted partition panels, is available in a variety of finishes and offers a great design alternative to our existing OUTLINES system.

**Outlines**

- Post and panel mount design
- Combine widths and panel heights to create continuous panel
- Posts available in black (BL) or aluminium (AL)
- Panels available in plexiglass, laminate, polycarbonate or tack-board panel finishes
- Compatible with Outlines Accessories
- Neo-Angle components
- Outlines hutches

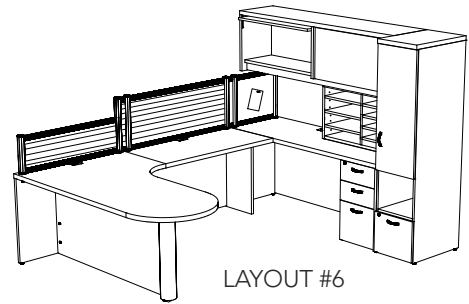
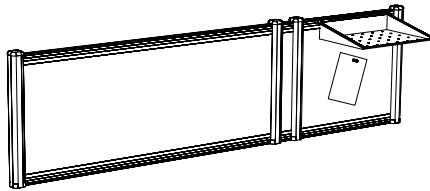

This versatile, desktop-mounted partition system can be used on most new or existing modular workstations, reception areas and office desks. Post and panels are used in combination to create privacy in a desired work space. The design of Outlines allows for the connection of panels in continuous line spanning over larger distances. Optional transaction tops, the ability to stack panels in different finishes and specialized, integrated hutches are key components to our traditional OUTLINES Series.

**Outlines *Plus*** - Simple bracket and panel mount design

- Two mounting bracket options
  - Top Mount (TM1) or Edge Mount (EM1)\*
  - Available in black (BL) or silver (SL)
  - Panels available in plexiglass, laminate or tack board finish
- \*Edge mount panels (EM1) - brackets are installed on the underside of work surface & can be removed without damaging the work surface (repetitive removal & re-attachment not recommended).

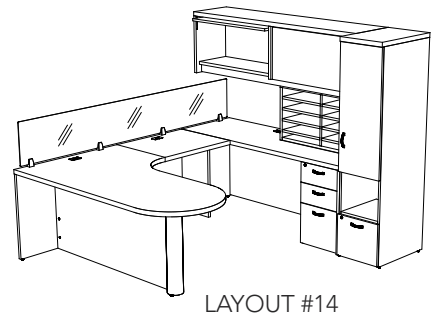
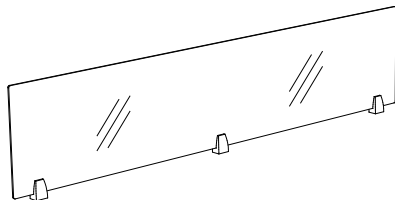

Simplicity is the key to Outlines *Plus*! Designed to minimize distractions while still facilitating an open team/ collaborative environment, it is the perfect solution when just that little extra bit of privacy or separation is needed. As with Outlines, Outlines *Plus* can be added to almost any new or existing workspace and is available in either an edge mount or top mount design. The aesthetically pleasing, clean lines of this panel system provide a natural boundary where needed but stops short of the enclosed environment that can be achieved with traditional Outlines.

*Understand the options ....*

**Surface Mounted Health Guard**

- Silver finish steel powder coat support brackets for secure surface mount
- Allows for taller & wider sizing
- 2 minute install
- Default sizing includes 5" high pass through between surface & underside of panel
- Best used for 24" - 48" high protection

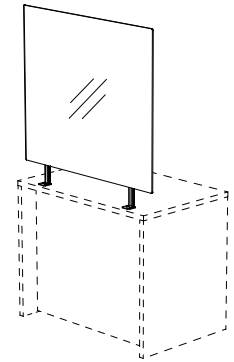

**Removable Protective Health Guard**

- Silver finish steel powder coat support brackets for clamp mount & secure connection to ¾" - 1½" laminate surfaces
- Easy removal - no screw holes left on surfaces
- 2 minute install
- Default sizing includes 5" high pass through between surface & underside of panel
- Best used for 24" - 48" high protection

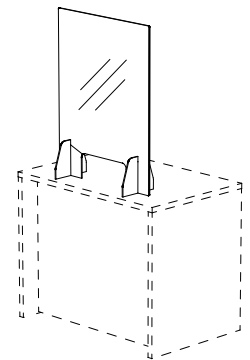
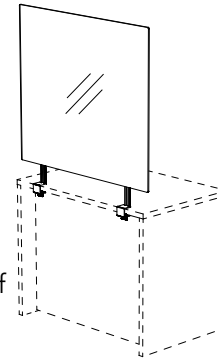

**Freestanding Health Guard**

- Easy to move around & easily removed
- Lowest cost panel option with 30 second install
- Includes pass through cut out (also available without pass through, same price)
- Maximum height of 32" recommended

**Desk Divider Panel with Plexiglass Top**

- Free standing partition for worksurface, includes levelers (improved stability by mounting to underside of worksurface)
- Fits either 24" or 30" tops
- Laminate base available in all standard Heartwood finishes with clear or frosted plexiglass topper
- Easily removed without damaging work surface

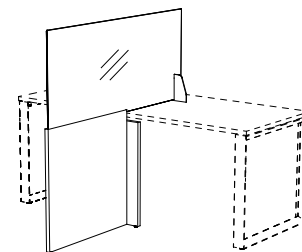

**Freestanding Divider Panel with Plexiglass Top**

- Free standing partition panel, includes levelers
- Easy to move around & easily removed
- Laminate panel available in all standard Heartwood finishes with clear or frosted plexiglass topper

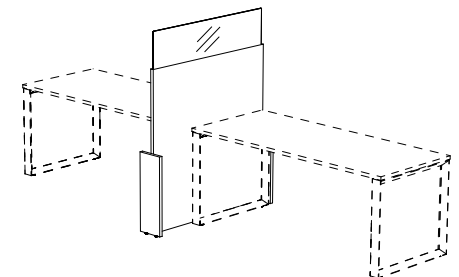

**Glass Panel Extensions or Desktop Panels**

- 5mm clear tempered glass panels
- Suitable for installation on HDL's Framework modular panel system or other third party panel system designs
- Suitable for desktop mount design installation
- Maximum height of 22" recommended
- Uses Outlines *Plus* mounting hardware

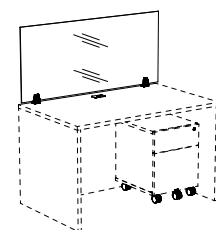
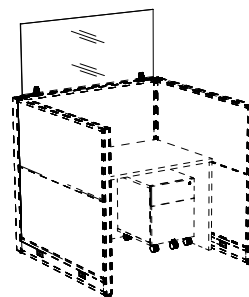

**Finishes**

| Laminate Finishes                                   |                    |
|---|--------------------|
| ABBR  | LAMINATE COLOUR    |
| AM  | Autumn Maple       |
| BL  | Black              |
| BW  | Black Walnut       |
| CD  | Cappuccino Dream** |
| CM  | Charcoal Matrix    |
| DE  | Desert Sand        |
| DD  | Driftwood***       |
| DW  | Driftwood Grey**   |
| EZ  | Evening Zen        |
| GA  | Golden Ash         |
| GD  | Grey Dusk          |
| GM  | Grey Matrix        |
| GR  | Grey               |
| GT  | Graphite           |
| HM  | Hardrock Maple     |
| NC  | Noce Cocoa         |
| PW  | Pure White         |
| RM  | Royal Mahogany     |
| SM  | Sugar Maple        |
| SW  | Seaside White      |
| VC  | Volcanic Ash       |
| WW  | Winter Wood        |
| WB  | White Board        |
| ** Textured Finish                                  |                    |
| *** Non-Textured Finish -<br>1" & 1½" laminate ONLY |                    |

**Finishes**

| Metal Finishes |           | OUTLINES     | OUTLINES <i>Plus</i> |            |
|----------------|-----------|--------------|----------------------|------------|
| ABBR           | COLOUR    | POST & RAILS | TOP MOUNT            | EDGE MOUNT |
| AL             | Aluminium | ✓            | X                    | X          |
| BL             | Black     | ✓            | ✓                    | ✓          |
| SL             | Silver    | X            | ✓                    | ✓          |

| Plexiglass Panel |         | OUTLINES | OUTLINES <i>Plus</i> |            |
|------------------|---------|----------|----------------------|------------|
| ABBR             | COLOUR  | PANELS   | TOP MOUNT            | EDGE MOUNT |
| BR               | Bronze  | ✓        | ✓                    | ✓          |
| CL               | Clear   | ✓        | ✓                    | ✓          |
| FR               | Frosted | ✓        | ✓                    | ✓          |

| Polycarbonate Panel |                      | OUTLINES | OUTLINES <i>Plus</i> |            |
|---------------------|----------------------|----------|----------------------|------------|
| ABBR                | COLOUR               | PANELS   | TOP MOUNT            | EDGE MOUNT |
| PYP                 | Ribbed Polycarbonate | ✓        | X                    | X          |

| Tack Board Panel |  | OUTLINES | OUTLINES <i>Plus</i> |            |
|------------------|--|----------|----------------------|------------|
| ABBR             | COLOUR   | PANELS   | TOP MOUNT            | EDGE MOUNT |
| XX               | All available Heartwood<br>tack board finishes | ✓        | ✓                    | ✓          |

| Acoustic PET Panel |               | OUTLINES | OUTLINES <i>Plus</i> |            |
|--------------------|---------------|----------|----------------------|------------|
| ABBR               | COLOUR        | PANELS   | TOP MOUNT            | EDGE MOUNT |
| CH                 | Charcoal Grey | X        | ✓                    | ✓          |
| ST                 | Storm Grey    | X        | ✓                    | ✓          |
| TN                 | Tan           | X        | ✓                    | ✓          |

**High Pressure (HP) laminate available** Contact Customer Service.  
White Board laminate available in ¾" only. Matching 2mm edge banding is not recommended as it may discolour.

**NOTE:** Outlines and Outlines Plus are metric series. If you are ordering to fit on existing imperial sized furniture (exact size), you must state that on your order so that we can convert to fit imperial. All components come supplied with all parts and hardware necessary for installation of the panel system in the field. **Reminder:** to order imperial exact sizing, add "i" in front of SKU's and add 5% price upcharge.

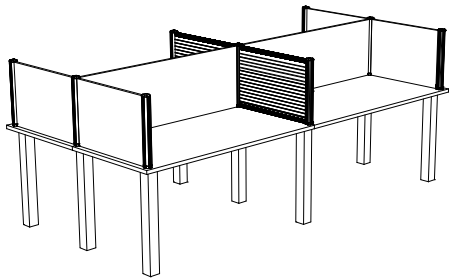

**OUTLINES - PAGE OUT-6 - OUT-38**

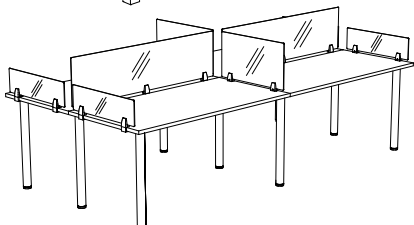

**OUTLINES *PLUS* - PAGE OUT-40 - OUT-62**

## Posts

- ♥ Sold separately in 5 standard heights: 6", 12", 18", 24" & 36".
- ♥ Available in two finishes – Black (BL) and Aluminum (AL).
- ♥ Mounts easily on the work surface from the top. No need to crawl under the desk.
- ♥ All mounting hardware and positioning templates included.

## Panels

- ♥ Available in four panel materials:
  1. Plexiglass (PLX), in 3 styles - Clear (CL), Frosted (FR), or Bronze (BR).
  2. Ribbed Polycarbonate (PYP), which allows light to pass through but obscures visibility.
  3. Laminate (LAM), in all standard Heartwood finishes.
  4. Tack-board (TBP), in all standard Heartwood fabrics.
- ♥ All four materials are available in 6", 12", 18" & 24" heights to create the level of privacy you require. These interlocking panels can be combined to reach a 36" height. Skus for 6" panel are not listed. For panel pricing use next size up pricing. For one piece 36" panels, please contact Customer Service.
- ♥ Connecting filler panels will be provided upon request. See panel order detail.
- ♥ Polycarbonate, plexiglass, and tack-board panels include aluminum top and bottom rails.
- ♥ Rails are available in two finishes – Black (BL) and Aluminum (AL). Please indicate your preference on your order.
- ♥ Laminate panels are available in all available Heartwood finishes and are finished on the top and bottom edges with matching 2mm edge band.
- ♥ Panels sized to include posts in overall dimension. Please order panels according to work surface/desk size.

## Transaction Tops

- ♥ Order in 1" (OUT1) or 1½" (OUT2) thicknesses to match our 388, 850 and 600 series.
- ♥ They may be ordered in any of Heartwood's laminate finishes except Black (BL) and Graphite (GT) as these two finishes do not perform well in work surface applications.
- ♥ All edges are finished with matching 2mm edge band. Optional, accent banding is available at no extra cost.
- ♥ 1½" tops are fluted, by default, to match 600 series tops. Please indicate on order if you do not require fluting.
- ♥ Transaction tops can be ordered with bullet ends or 1½" radius ends. Contact Customer Service for pricing and sizing information.
- ♥ Send in your drawings and we will be happy to send you a quote.

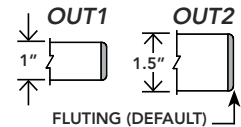

## Hutches

- ♥ Order standard 24" panels in the 4 available panel styles when a hutch back is required
- ♥ Standard panel lengths can be connected to hutch support posts creating a continuous privacy panel or support for transaction tops
- ♥ Hutch filler panels fit between side hutch support posts providing the privacy of a traditional hutch
- ♥ Laminate and aluminum frame plexiglass hutch doors (AGD) hang below the fixed shelf for easy finger pull and do not come with handles. Handles may be added by request (see page **100-3**) for selection details.
- ♥ Order in 1" (OUT1) or 1½" (OUT2) thicknesses to match our 388, 850 and 600 series tops.
- ♥ Hutches may be ordered in any of Heartwood's laminate finishes.
- ♥ All edges are finished with matching 2mm edge band. Optional, accent banding is available at no extra cost.
- ♥ 1½" tops are fluted, by default, to match 600 series tops. Please indicate on order if you do not require fluting.

## Drawers

- ♥ All drawers are 5 pieces - 4 x 1/2" black sides & 1 x 1/8" black bottom.
- ♥ Handles are standard on all cabinet doors and drawers, see Accessories page **100-3** to make your selection.
- ♥ All box and file drawers mounted on FULL extension ball bearing slides, 100 lb. load rating.
- ♥ Lateral file drawers mounted on FULL extension ball bearing slides, 150 lb. load rating
- ♥ Each file drawer features side rails and adjustable file bars that accommodate front-to-back letter or side to side legal sized hanging folders.
- ♥ One pencil tray included with every box drawer unit.

**NOTE:** All file and lateral file drawers are constructed to support hanging file folders. Broken drawer bottoms are not covered by warranty. If you expect to store heavy items, ie. phone books, paper etc. on the drawer bottom, we offer an optional ½" bottom for these drawers. Please contact Customer Service for pricing.



**Locks**

- ♥ All laminate storage cabinets doors and drawers lock, **except where noted in the price book.**
- ♥ Laminate hutch doors do not lock, unless requested. There is a **\$76** up-charge.
- ♥ To add an optional lock to a component or Aluminum Glazed Doors (AGD), add **-L** to the SKU and upcharge of **\$76**
- ♥ Core removable locks are standard on all drawer pedestals, lateral files and storage cabinets.
  - > For keyed -alike locks, indicate on your order, which standard units you would like keyed-alike.
  - > Order the appropriate quantity of like numbered cores required at **\$11** each.

**Ordering Example:** If you require 3 units to be keyed alike, **order 100-COREPACK-3 (\$11 x 3 = \$33).**

**Optional Boot Shelves:**

- ♥ Tall wardrobe storage & storage cabinets can have an optional boot shelf. Upcharges apply when ordering bootshelf: add **-BS** to product SKU.

> **Ordering Example:** OUT-7036WC-20-BS

| Bootshelf Upcharges |              |
|---------------------|--------------|
| 12" w to 23" w      | <b>\$119</b> |
| 24" w to 35" w      | <b>\$134</b> |
| 36" w or >          | <b>\$174</b> |

**Accessories**

- ♥ See 100 Series for a complete list of Heartwood accessories. See page **OUT-9** for Outlines accessories.

**Custom Sizes**

- ♥ Custom available.....call Customer Service. Please specify quote number when ordering. For Simple Width; changes, use the price of the next size up.

**Ordering Example :** To price a custom size Outlines panel OUT-1846PYP **use the pricing for** OUT-1848PYP.

**Shipping**

- ♥ Some items are shipped fully assembled, some are shipped in RTA cartoning. Look for rta **symbol RTA** at each model number.

**NOTE:** Information is current at time of print. For up to date information check online at [www.heartwood.ca](http://www.heartwood.ca)

**Outlines Panel Configuration Overview**

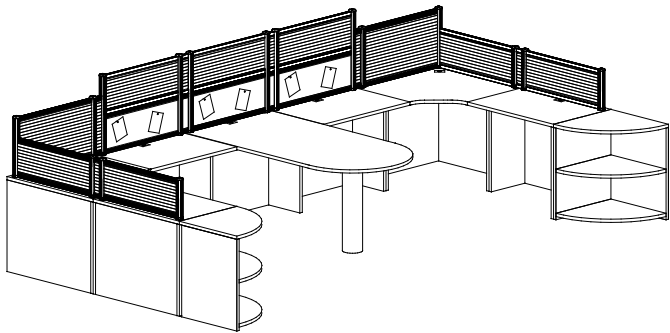

12" PANEL



18" PANEL



24" PANEL

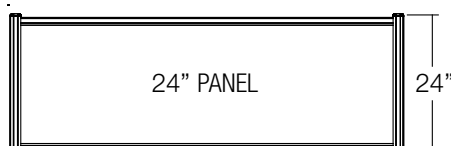

36" PANEL

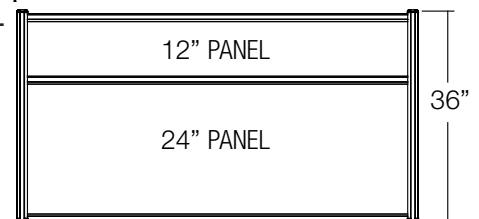

COMBINATION

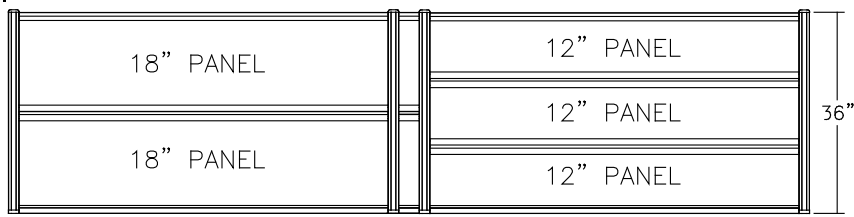

COMBINATION

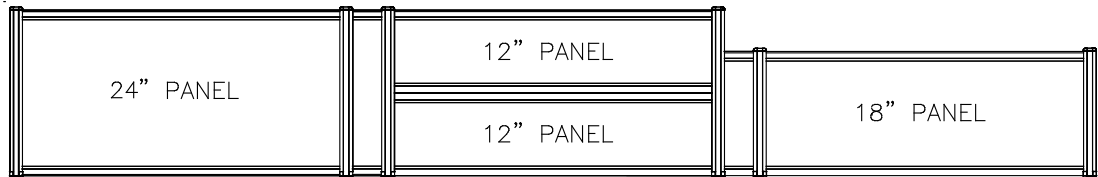

COMBINATION

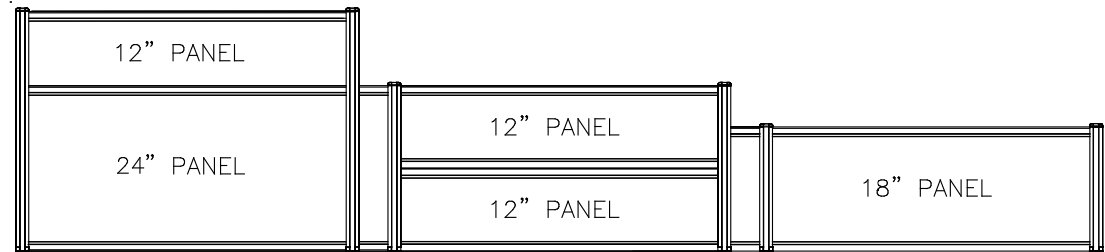

HUTCH COMBINATION

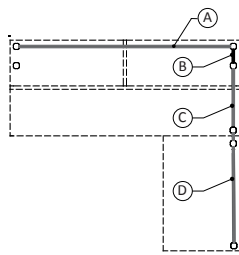
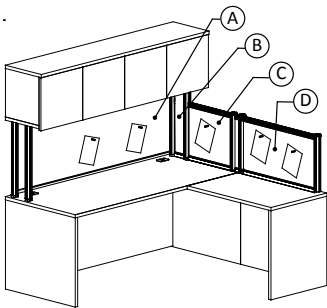

| ITEMS    | ITEM DESCRIPTION   | QTY | LIST           |
|----------|--|-----|----------------|
|          | <b>OUT1-4172HHD</b> 41" HUTCH W/ HINGED LAMINATE DOORS       | 1 x | <b>\$1,456</b> |
| <b>A</b> | <b>OUT-2472TBP</b> STANDARD TACK-BOARD PANEL                 | 1 x | <b>\$586</b>   |
| <b>B</b> | <b>OUT-24TBP-HFP</b> HUTCH FILLER PANEL - TACK-BOARD (SEE A) | 1 x | <b>\$249</b>   |
| <b>C</b> | <b>OUT-1824TBP</b> 18" TACK BOARD PANELS                     | 1 x | <b>\$285</b>   |
| <b>D</b> | <b>OUT-1848TBP-F</b> STANDARD TACK-BOARD PANEL W/ FILLER     | 1 x | <b>\$377</b>   |
|          | <b>OUT-18POST</b> POST PACKAGES                              | 3 x | <b>\$113</b>   |
|          | <b>388-3072CT-A</b> 30" CONNECTOR TOP W/ A GABLE SET         | 1 x | <b>\$879</b>   |
|          | <b>388-2448RS</b> 24" NON-HANDED RETURN SHELL                | 1 x | <b>\$655</b>   |
|          | <b>TOTAL</b>   |     | <b>\$3923</b>  |

**NOTE:** HUTCH FILLER PANELS FIT BETWEEN HUTCH SUPPORT POSTS (**SEE B**). IN COMBINATION WITH STANDARD PANELS (**SEE C**), A CONTINUOUS PRIVACY PANEL OR SUPPORT FOR TRANSACTION TOPS CAN BE CREATED.

- 24" DEEP WORK SURFACE USE 18" PANEL.
- 36" DEEP WORK SURFACE USE 30" PANEL
- \*\* 24" HIGH PANELS CAN ONLY CONNECT TO OPEN HUTCHES

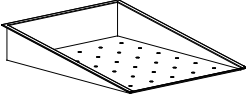
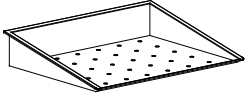
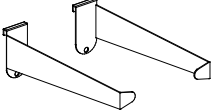
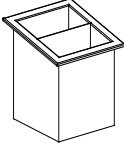
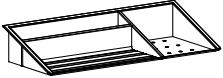
|  | MODEL   | LIST | WEIGHT<br>LBS | CUBE<br>FT <sup>3</sup> | W<br>IN | D<br>IN | H<br>IN |
|--|---|------|---------------|-------------------------|---------|---------|---------|
|   | <b>LETTER TRAY - PORTRAIT</b><br>RAIL MOUNTED PLASTIC LETTER TRAY     |      |               |                         |         |         |         |
|  | OUT-LTRPRT  | \$68 | 0.5           | 0.2                     | 11      | 14      | 2.5     |
|   | <b>LETTER TRAY - LANDSCAPE</b><br>RAIL MOUNTED PLASTIC LETTER TRAY    |      |               |                         |         |         |         |
|  | OUT-LTRLND  | \$68 | 0.5           | 0.2                     | 14      | 11      | 2.5     |
|   | <b>HANGING FILE BRACKET - PAIR</b><br>RAIL MOUNTED METAL FILE HANGERS |      |               |                         |         |         |         |
|  | OUT-HFRAIL  | \$46 | 0.3           | 0.03                    | 2.5     | 8       | 2.5     |
|   | <b>PENCIL CUP</b><br>RAIL MOUNTED PLASTIC PENCIL CUP                  |      |               |                         |         |         |         |
|  | OUT-PENCUP  | \$28 | 0.1           | 0.1                     | 7       | 3.5     | 4       |
|  | <b>ACCESSORY TRAY</b><br>RAIL MOUNTED PLASTIC ACCESSORY TRAY          |      |               |                         |         |         |         |
|  | OUT-ACCTRY  | \$59 | 0.4           | 0.1                     | 15      | 6       | 2.5     |

**OUTLINES POST PACKAGES**

1 POST PER PACKAGE ALL MOUNTING HARDWARE INCLUDED

|            |       |     |      |   |   |       |
|------------|-------|-----|------|---|---|-------|
| OUT-6POST  | \$94  | .7  | 0.01 | 2 | 2 | 6     |
| OUT-12POST | \$94  | 1.0 | 0.04 | 2 | 2 | 12.5  |
| OUT-18POST | \$113 | 2   | 0.06 | 2 | 2 | 18.5  |
| OUT-24POST | \$158 | 2   | 0.07 | 2 | 2 | 24.25 |
| OUT-36POST | \$249 | 4   | 0.1  | 2 | 2 | 36.25 |

**AVAILABLE FINISHES:** BLACK (BL) OR ALUMINIUM (AL) PLEASE SPECIFY FINISH WHEN ORDERING

**FILLERS**

**FILLER PANEL**

ONE FILLER PANEL PER PACKAGE, ALL MOUNTING HARDWARE INCLUDED.

|            |      |     |      |     |     |                   |
|------------|------|-----|------|-----|-----|-------------------|
| OUT-FILLER | \$71 | 0.2 | 0.05 | 2.5 | .75 | 6/12/18/<br>24/36 |
|------------|------|-----|------|-----|-----|-------------------|

**AVAILABLE FINISH:** BLACK (BL) OR SILVER (SL)

- PLEASE SPECIFY RAIL FINISH, PANEL FINISH AND SIZE WHEN ORDERING **EXAMPLE** OUT-24FILLER-PLX-FR.
- NO CHARGE FOR FILLER PANELS WHEN ORDERED WITH A PANEL, ONLY EXTRA IF ORDERED ON IT'S OWN.

**RTA**

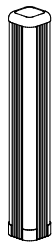

**RTA**



| MODEL | LIST | WEIGHT | CUBE            | W  | D  | H  |
|-------|------|--------|-----------------|----|----|----|
|       |      | LBS    | FT <sup>3</sup> | IN | IN | IN |

**12" POLYCARBONATE PANELS**

ALL MOUNTING HARDWARE INCLUDED

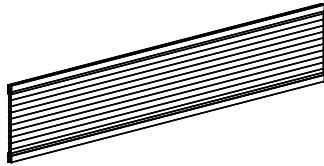

OUT-1272PYP

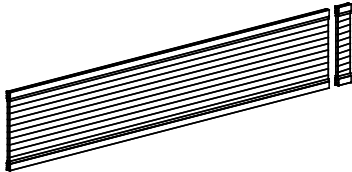

OUT-1272PYP-F

|             |       |    |      |       |      |    |
|-------------|-------|----|------|-------|------|----|
| OUT-1218PYP | \$206 | 3  | 0.15 | 12.75 | 0.75 | 12 |
| OUT-1224PYP | \$206 | 3  | 0.17 | 18.5  | 0.75 | 12 |
| OUT-1230PYP | \$240 | 4  | 0.21 | 24.5  | 0.75 | 12 |
| OUT-1236PYP | \$289 | 5  | 0.25 | 30.5  | 0.75 | 12 |
| OUT-1242PYP | \$323 | 6  | 0.3  | 36.25 | 0.75 | 12 |
| OUT-1248PYP | \$386 | 7  | 0.35 | 42.25 | 0.75 | 12 |
| OUT-1254PYP | \$414 | 8  | 0.4  | 48    | 0.75 | 12 |
| OUT-1260PYP | \$469 | 9  | 0.45 | 54    | 0.75 | 12 |
| OUT-1266PYP | \$504 | 10 | 0.5  | 60    | 0.75 | 12 |
| OUT-1272PYP | \$545 | 11 | 0.55 | 65.75 | 0.75 | 12 |

- IF A FILLER IS REQUIRED, PLEASE **ADD A "-F"** TO THE END OF THE MODEL NUMBER, **Example:** OUT-1266PYP-F. THERE IS NO EXTRA CHARGE FOR FILLERS WHEN ORDERED W/ PANELS.
- TOP & BOTTOM RAILS AVAILABLE IN BLACK (BL) OR ALUMINIUM (AL) FINISH. **PLEASE SPECIFY RAIL FINISH ON YOUR ORDER.**

RTA

**18" POLYCARBONATE PANELS**

ALL MOUNTING HARDWARE INCLUDED

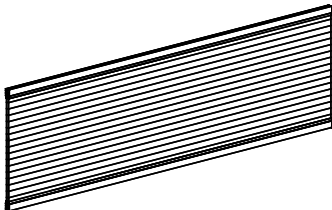

OUT-1872PYP

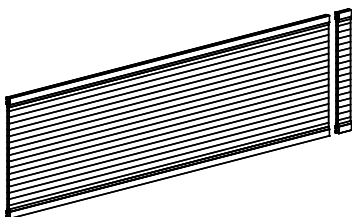

OUT-1872PYP-F

|             |       |    |      |       |      |       |
|-------------|-------|----|------|-------|------|-------|
| OUT-1818PYP | \$240 | 5  | 0.23 | 12.75 | 0.75 | 17.75 |
| OUT-1824PYP | \$240 | 5  | 0.25 | 18.5  | 0.75 | 17.75 |
| OUT-1830PYP | \$277 | 6  | 0.3  | 24.5  | 0.75 | 17.75 |
| OUT-1836PYP | \$317 | 8  | 0.38 | 30.5  | 0.75 | 17.75 |
| OUT-1842PYP | \$359 | 9  | 0.44 | 36.25 | 0.75 | 17.75 |
| OUT-1848PYP | \$435 | 10 | 0.5  | 42.25 | 0.75 | 17.75 |
| OUT-1854PYP | \$482 | 11 | 0.56 | 48    | 0.75 | 17.75 |
| OUT-1860PYP | \$516 | 12 | 0.62 | 54    | 0.75 | 17.75 |
| OUT-1866PYP | \$566 | 14 | 0.69 | 60    | 0.75 | 17.75 |
| OUT-1872PYP | \$606 | 15 | 0.75 | 65.75 | 0.75 | 17.75 |

- IF A FILLER IS REQUIRED, PLEASE **ADD A "-F"** TO THE END OF THE MODEL NUMBER, **Example:** OUT-1866PYP-F. THERE IS NO EXTRA CHARGE FOR FILLERS WHEN ORDERED W/ PANELS.
- TOP & BOTTOM RAILS AVAILABLE IN BLACK (BL) OR ALUMINIUM (AL) FINISH. **PLEASE SPECIFY RAIL FINISH ON YOUR ORDER.**

RTA

| MODEL | LIST | WEIGHT | CUBE            | W  | D  | H  |
|-------|------|--------|-----------------|----|----|----|
|       |      | LBS    | FT <sup>3</sup> | IN | IN | IN |

**24" POLYCARBONATE PANELS**

ALL MOUNTING HARDWARE INCLUDED

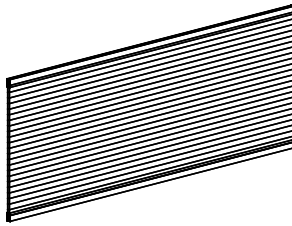

OUT-2472PYP

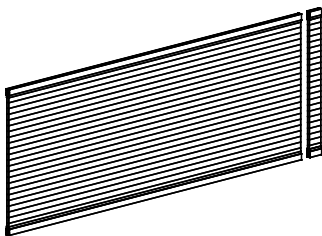

OUT-2472PYP-F

RTA

|             |       |    |      |       |      |       |
|-------------|-------|----|------|-------|------|-------|
| OUT-2424PYP | \$268 | 7  | 0.33 | 18.5  | 0.75 | 23.75 |
| OUT-2430PYP | \$317 | 8  | 0.42 | 24.5  | 0.75 | 23.75 |
| OUT-2436PYP | \$372 | 10 | 0.5  | 30.5  | 0.75 | 23.75 |
| OUT-2442PYP | \$419 | 12 | 0.58 | 36.25 | 0.75 | 23.75 |
| OUT-2448PYP | \$496 | 13 | 0.67 | 42.25 | 0.75 | 23.75 |
| OUT-2454PYP | \$532 | 15 | 0.75 | 48    | 0.75 | 23.75 |
| OUT-2460PYP | \$600 | 17 | 0.83 | 54    | 0.75 | 23.75 |
| OUT-2466PYP | \$655 | 18 | 0.92 | 60    | 0.75 | 23.75 |
| OUT-2472PYP | \$710 | 20 | 1    | 65.75 | 0.75 | 23.75 |

- IF A FILLER IS REQUIRED, PLEASE **ADD A "-F"** TO THE END OF THE MODEL NUMBER, **Example:** OUT-2466PYP-F. THERE IS NO EXTRA CHARGE FOR FILLERS WHEN ORDERED W/ PANELS.
- TOP & BOTTOM RAILS AVAILABLE IN BLACK (BL) OR ALUMINIUM (AL) FINISH. **PLEASE SPECIFY RAIL FINISH ON YOUR ORDER.**

**PLEXIGLASS PANELS**

**12" PLEXIGLASS PANELS**

ALL MOUNTING HARDWARE INCLUDED.

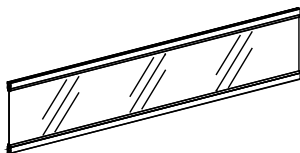

OUT-1272PLX

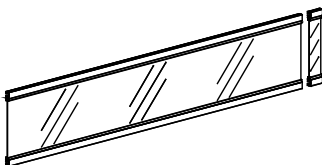

OUT-1272PLX-F

RTA

|             |       |    |      |       |      |    |
|-------------|-------|----|------|-------|------|----|
| OUT-1224PLX | \$218 | 7  | 0.17 | 18.5  | 0.75 | 12 |
| OUT-1230PLX | \$252 | 9  | 0.21 | 24.5  | 0.75 | 12 |
| OUT-1236PLX | \$299 | 12 | 0.25 | 30.5  | 0.75 | 12 |
| OUT-1242PLX | \$325 | 14 | 0.3  | 36.25 | 0.75 | 12 |
| OUT-1248PLX | \$400 | 16 | 0.35 | 42.25 | 0.75 | 12 |
| OUT-1254PLX | \$422 | 18 | 0.4  | 48    | 0.75 | 12 |
| OUT-1260PLX | \$469 | 21 | 0.45 | 54    | 0.75 | 12 |
| OUT-1266PLX | \$513 | 23 | 0.5  | 60    | 0.75 | 12 |
| OUT-1272PLX | \$555 | 25 | 0.55 | 65.75 | 0.75 | 12 |

- IF A FILLER IS REQUIRED, PLEASE **ADD A "-F"** TO THE END OF THE MODEL NUMBER, **Example:** OUT-1266PLX-F. THERE IS NO EXTRA CHARGE FOR FILLERS WHEN ORDERED W/ PANELS.
- TOP & BOTTOM RAILS AVAILABLE IN BLACK (BL) OR ALUMINIUM (AL) FINISH. **PLEASE SPECIFY RAIL FINISH ON YOUR ORDER.**
- PLEXI PANELS ARE AVAILABLE IN CLEAR (CL), FROSTED (FR) OR BRONZE (BR). INDICATE YOUR CHOICE ON YOUR ORDER.

| MODEL | LIST | WEIGHT | CUBE            | W  | D  | H  |
|-------|------|--------|-----------------|----|----|----|
|       |      | LBS    | FT <sup>3</sup> | IN | IN | IN |

**18" PLEXIGLASS PANELS**

ALL MOUNTING HARDWARE INCLUDED

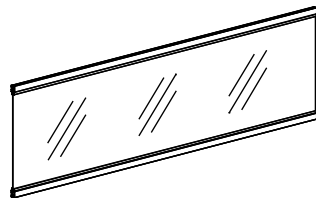

OUT-1842PLX

|             |       |    |      |       |      |       |
|-------------|-------|----|------|-------|------|-------|
| OUT-1824PLX | \$258 | 10 | 0.25 | 18.5  | 0.75 | 17.75 |
| OUT-1830PLX | \$292 | 13 | 0.3  | 24.5  | 0.75 | 17.75 |
| OUT-1836PLX | \$335 | 16 | 0.38 | 30.5  | 0.75 | 17.75 |
| OUT-1842PLX | \$373 | 19 | 0.44 | 36.25 | 0.75 | 17.75 |
| OUT-1848PLX | \$460 | 23 | 0.5  | 42.25 | 0.75 | 17.75 |
| OUT-1854PLX | \$495 | 26 | 0.56 | 48    | 0.75 | 17.75 |
| OUT-1860PLX | \$528 | 29 | 0.62 | 54    | 0.75 | 17.75 |
| OUT-1866PLX | \$570 | 32 | 0.69 | 60    | 0.75 | 17.75 |
| OUT-1872PLX | \$607 | 35 | 0.75 | 65.25 | 0.75 | 17.75 |

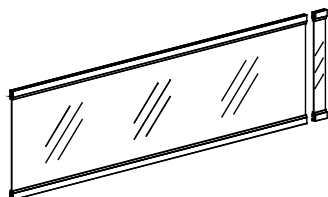

OUT-1842PLX-F

- IF A FILLER IS REQUIRED, PLEASE **ADD A "-F"** TO THE END OF THE MODEL NUMBER, **Example:** OUT-1866PLX-F. THERE IS NO EXTRA CHARGE FOR FILLERS WHEN ORDERED W/ PANELS.
- TOP & BOTTOM RAILS AVAILABLE IN BLACK (BL) OR ALUMINIUM (AL) FINISH. **PLEASE SPECIFY RAIL FINISH ON YOUR ORDER.**
- PLEXI PANELS ARE AVAILABLE IN CLEAR (CL), FROSTED (FR) OR BRONZE (BR). INDICATE YOUR CHOICE ON YOUR ORDER.

RTA

**24" PLEXIGLASS PANELS**

ALL MOUNTING HARDWARE INCLUDED

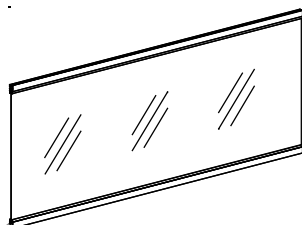

OUT-2472PLX

|             |       |    |      |       |      |       |
|-------------|-------|----|------|-------|------|-------|
| OUT-2424PLX | \$285 | 13 | 0.33 | 18.5  | 0.75 | 23.75 |
| OUT-2430PLX | \$334 | 17 | 0.42 | 24.5  | 0.75 | 23.75 |
| OUT-2436PLX | \$386 | 21 | 0.5  | 30.5  | 0.75 | 23.75 |
| OUT-2442PLX | \$435 | 25 | 0.58 | 36.25 | 0.75 | 23.75 |
| OUT-2448PLX | \$507 | 29 | 0.67 | 42.25 | 0.75 | 23.75 |
| OUT-2454PLX | \$542 | 34 | 0.75 | 48    | 0.75 | 23.75 |
| OUT-2460PLX | \$603 | 38 | 0.83 | 54    | 0.75 | 23.75 |
| OUT-2466PLX | \$656 | 42 | 0.92 | 60    | 0.75 | 23.75 |
| OUT-2472PLX | \$712 | 46 | 1    | 65.75 | 0.75 | 23.75 |

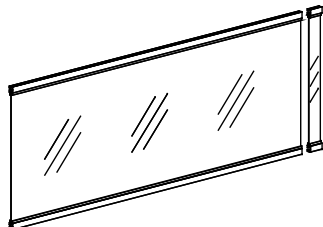

OUT-2472PLX-F

- IF A FILLER IS REQUIRED, PLEASE **ADD A "-F"** TO THE END OF THE MODEL NUMBER, **Example:** OUT-2466PLX-F. THERE IS NO EXTRA CHARGE FOR FILLERS WHEN ORDERED W/ PANELS.
- TOP & BOTTOM RAILS AVAILABLE IN BLACK (BL) OR ALUMINIUM (AL) FINISH. **PLEASE SPECIFY RAIL FINISH ON YOUR ORDER.**
- PLEXI PANELS ARE AVAILABLE IN CLEAR (CL), FROSTED (FR) OR BRONZE (BR). INDICATE YOUR CHOICE ON YOUR ORDER.

RTA

| MODEL | LIST | WEIGHT | CUBE            | W  | D  | H  |
|-------|------|--------|-----------------|----|----|----|
|       |      | LBS    | FT <sup>3</sup> | IN | IN | IN |

**12" TACK BOARD PANELS**

ALL MOUNTING HARDWARE INCLUDED

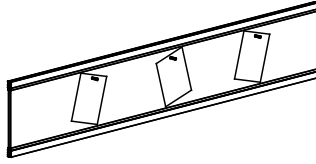

OUT-1272TBP

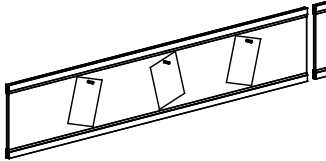

OUT-1272TBP-F

|             |       |    |      |       |      |    |
|-------------|-------|----|------|-------|------|----|
| OUT-1218TBP | \$263 | 5  | 0.15 | 12.75 | 0.75 | 12 |
| OUT-1224TBP | \$263 | 5  | 0.17 | 18.5  | 0.75 | 12 |
| OUT-1230TBP | \$289 | 7  | 0.21 | 24.5  | 0.75 | 12 |
| OUT-1236TBP | \$311 | 8  | 0.25 | 30.5  | 0.75 | 12 |
| OUT-1242TBP | \$338 | 10 | 0.3  | 36.25 | 0.75 | 12 |
| OUT-1248TBP | \$359 | 11 | 0.35 | 42.25 | 0.75 | 12 |
| OUT-1254TBP | \$394 | 13 | 0.4  | 48    | 0.75 | 12 |
| OUT-1260TBP | \$414 | 14 | 0.45 | 54    | 0.75 | 12 |
| OUT-1266TBP | \$448 | 16 | 0.5  | 60    | 0.75 | 12 |
| OUT-1272TBP | \$482 | 18 | 0.55 | 65.75 | 0.75 | 12 |

- IF A FILLER IS REQUIRED, PLEASE **ADD A "-F"** TO THE END OF THE MODEL NUMBER, **Example:** OUT-1266TBP-F. THERE IS NO EXTRA CHARGE FOR FILLERS WHEN ORDERED W/ PANELS.
- TOP & BOTTOM RAILS AVAILABLE IN BLACK (BL) OR ALUMINIUM (AL) FINISH. **PLEASE SPECIFY RAIL FINISH ON YOUR ORDER.**
- **FABRIC COLORS:** PLEASE REFER TO THE CURRENT HEARTWOOD FABRIC SAMPLE CARD OR THE FINISHES & FABRICS TAB ON THE [WWW.HEARTWOOD.CA](http://WWW.HEARTWOOD.CA) WEBSITE FOR A COMPLETE COLOUR CHOICE LISTING.

RTA

**18" TACK BOARD PANELS**

ALL MOUNTING HARDWARE INCLUDED

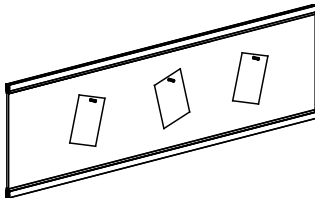

OUT-1872TBP

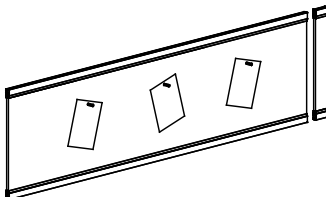

OUT-1872TBP-F

|             |       |    |      |       |      |       |
|-------------|-------|----|------|-------|------|-------|
| OUT-1818TBP | \$285 | 8  | 0.23 | 12.75 | 0.75 | 17.75 |
| OUT-1824TBP | \$285 | 8  | 0.25 | 18.5  | 0.75 | 17.75 |
| OUT-1830TBP | \$311 | 10 | 0.3  | 24.5  | 0.75 | 17.75 |
| OUT-1836TBP | \$332 | 12 | 0.38 | 30.5  | 0.75 | 17.75 |
| OUT-1842TBP | \$354 | 14 | 0.44 | 36.25 | 0.75 | 17.75 |
| OUT-1848TBP | \$377 | 16 | 0.5  | 42.25 | 0.75 | 17.75 |
| OUT-1854TBP | \$400 | 18 | 0.56 | 48    | 0.75 | 17.75 |
| OUT-1860TBP | \$414 | 20 | 0.62 | 54    | 0.75 | 17.75 |
| OUT-1866TBP | \$523 | 22 | 0.69 | 60    | 0.75 | 17.75 |
| OUT-1872TBP | \$566 | 24 | 0.75 | 65.25 | 0.75 | 17.75 |

- IF A FILLER IS REQUIRED, PLEASE **ADD A "-F"** TO THE END OF THE MODEL NUMBER, **Example:** OUT-1866TBP-F. THERE IS NO EXTRA CHARGE FOR FILLERS WHEN ORDERED W/ PANELS.
- TOP & BOTTOM RAILS AVAILABLE IN BLACK (BL) OR ALUMINIUM (AL) FINISH. **PLEASE SPECIFY RAIL FINISH ON YOUR ORDER.**
- **FABRIC COLORS:** PLEASE REFER TO THE CURRENT HEARTWOOD FABRIC SAMPLE CARD OR THE FINISHES & FABRICS TAB ON THE [WWW.HEARTWOOD.CA](http://WWW.HEARTWOOD.CA) WEBSITE FOR A COMPLETE COLOUR CHOICE LISTING.

RTA

## OUTLINES PANELS TACK-BOARD PANELS

| MODEL | LIST | WEIGHT | CUBE            | W  | D  | H  |
|-------|------|--------|-----------------|----|----|----|
|       |      | LBS    | FT <sup>3</sup> | IN | IN | IN |

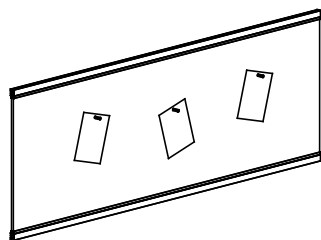

OUT-2472TBP

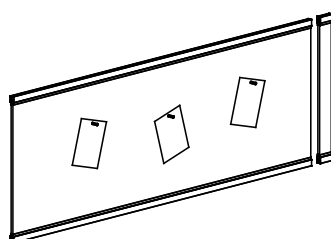

OUT-2472TBP-F

### 24" TACK BOARD PANELS

ALL MOUNTING HARDWARE INCLUDED

|             |       |    |      |       |      |       |
|-------------|-------|----|------|-------|------|-------|
| OUT-2424TBP | \$277 | 11 | 0.33 | 18.5  | 0.75 | 23.75 |
| OUT-2430TBP | \$338 | 13 | 0.42 | 24.5  | 0.75 | 23.75 |
| OUT-2436TBP | \$359 | 16 | 0.5  | 30.5  | 0.75 | 23.75 |
| OUT-2442TBP | \$394 | 19 | 0.58 | 36.25 | 0.75 | 23.75 |
| OUT-2448TBP | \$414 | 21 | 0.67 | 42.25 | 0.75 | 23.75 |
| OUT-2454TBP | \$482 | 24 | 0.75 | 48    | 0.75 | 23.75 |
| OUT-2460TBP | \$511 | 27 | 0.83 | 54    | 0.75 | 23.75 |
| OUT-2466TBP | \$545 | 29 | 0.92 | 60    | 0.75 | 23.75 |
| OUT-2472TBP | \$586 | 32 | 1.0  | 65.75 | 0.75 | 23.75 |

- IF A FILLER IS REQUIRED, PLEASE **ADD A "-F"** TO THE END OF THE MODEL NUMBER, **Example:** OUT-2466TBP-F. THERE IS NO EXTRA CHARGE FOR FILLERS WHEN ORDERED W/ PANELS.
- TOP & BOTTOM RAILS AVAILABLE IN BLACK (BL) OR ALUMINIUM (AL) FINISH. **PLEASE SPECIFY RAIL FINISH ON YOUR ORDER.**
- **FABRIC COLORS:** PLEASE REFER TO THE CURRENT HEARTWOOD FABRIC SAMPLE CARD OR THE FINISHES & FABRICS TAB ON THE [WWW.HEARTWOOD.CA](http://WWW.HEARTWOOD.CA) WEBSITE FOR A COMPLETE COLOUR CHOICE LISTING.

RTA

## LAMINATE PANELS

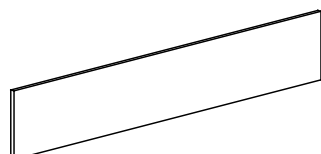

OUT-1272LAP

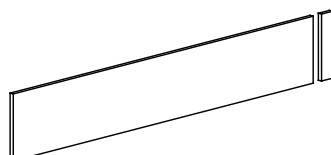

OUT-1272LAP-F

### 12" LAMINATE PANELS

ALL MOUNTING HARDWARE INCLUDED. TOP & BOTTOM EDGE PROTECTED W/ MATCHING 2MM EDGE BAND

|             |       |    |      |       |      |    |
|-------------|-------|----|------|-------|------|----|
| OUT-1218LAP | \$127 | 7  | 0.15 | 12.75 | 0.75 | 12 |
| OUT-1224LAP | \$127 | 8  | 0.17 | 18.5  | 0.75 | 12 |
| OUT-1230LAP | \$137 | 9  | 0.21 | 24.5  | 0.75 | 12 |
| OUT-1236LAP | \$148 | 11 | 0.25 | 30.5  | 0.75 | 12 |
| OUT-1242LAP | \$162 | 14 | 0.3  | 36.25 | 0.75 | 12 |
| OUT-1248LAP | \$178 | 16 | 0.35 | 42.25 | 0.75 | 12 |
| OUT-1254LAP | \$183 | 18 | 0.4  | 48    | 0.75 | 12 |
| OUT-1260LAP | \$191 | 20 | 0.45 | 54    | 0.75 | 12 |
| OUT-1266LAP | \$205 | 23 | 0.5  | 60    | 0.75 | 12 |
| OUT-1272LAP | \$218 | 25 | 0.55 | 65.75 | 0.75 | 12 |

- IF A FILLER IS REQUIRED, PLEASE **ADD A "-F"** TO THE END OF THE MODEL NUMBER, **Example:** OUT-1266LAP-F. THERE IS NO EXTRA CHARGE FOR FILLERS WHEN ORDERED W/ PANELS.

RTA



| MODEL | LIST | WEIGHT | CUBE            | W  | D  | H  |
|-------|------|--------|-----------------|----|----|----|
|       |      | LBS    | FT <sup>3</sup> | IN | IN | IN |

**18" LAMINATE PANELS**

ALL MOUNTING HARDWARE INCLUDED. TOP & BOTTOM EDGE PROTECTED W/ MATCHING 2MM EDGE BAND

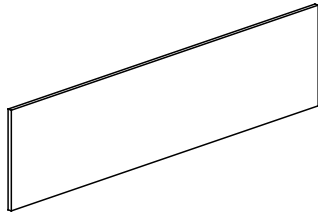

OUT-1872LAP

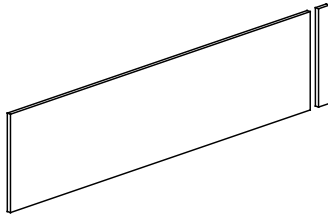

OUT-1872LAP-F

|             |       |    |      |       |      |       |
|-------------|-------|----|------|-------|------|-------|
| OUT-1818LAP | \$137 | 11 | 0.23 | 12.75 | 0.75 | 17.75 |
| OUT-1824LAP | \$137 | 11 | 0.25 | 18.5  | 0.75 | 17.75 |
| OUT-1830LAP | \$148 | 14 | 0.3  | 24.5  | 0.75 | 17.75 |
| OUT-1836LAP | \$162 | 17 | 0.38 | 30.5  | 0.75 | 17.75 |
| OUT-1842LAP | \$183 | 20 | 0.44 | 36.25 | 0.75 | 17.75 |
| OUT-1848LAP | \$205 | 23 | 0.5  | 42.25 | 0.75 | 17.75 |
| OUT-1854LAP | \$211 | 25 | 0.56 | 48    | 0.75 | 17.75 |
| OUT-1860LAP | \$218 | 28 | 0.62 | 54    | 0.75 | 17.75 |
| OUT-1866LAP | \$237 | 31 | 0.69 | 60    | 0.75 | 17.75 |
| OUT-1872LAP | \$259 | 34 | 0.75 | 65.75 | 0.75 | 17.75 |

- IF A FILLER IS REQUIRED, PLEASE **ADD A "-F"** TO THE END OF THE MODEL NUMBER, **Example:** OUT-1866LAP-F. THERE IS NO EXTRA CHARGE FOR FILLERS WHEN ORDERED W/ PANELS.

RTA

**24" LAMINATE PANELS**

ALL MOUNTING HARDWARE INCLUDED. TOP & BOTTOM EDGE PROTECTED W/ MATCHING 2MM EDGE BAND.

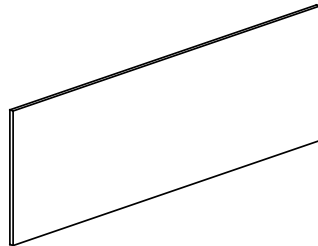

OUT-2472LAP

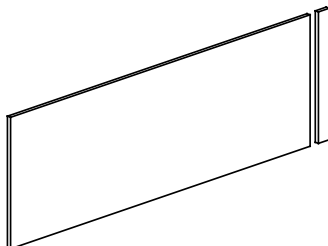

OUT-2472LAP-F

|             |       |    |      |       |      |       |
|-------------|-------|----|------|-------|------|-------|
| OUT-2424LAP | \$141 | 15 | 0.33 | 18.5  | 18.5 | 23.75 |
| OUT-2430LAP | \$162 | 19 | 0.42 | 24.5  | 0.75 | 23.75 |
| OUT-2436LAP | \$183 | 23 | 0.5  | 30.5  | 0.75 | 23.75 |
| OUT-2442LAP | \$205 | 26 | 0.58 | 36.25 | 0.75 | 23.75 |
| OUT-2448LAP | \$225 | 30 | 0.67 | 42.25 | 0.75 | 23.75 |
| OUT-2454LAP | \$237 | 34 | 0.75 | 48    | 0.75 | 23.75 |
| OUT-2460LAP | \$245 | 37 | 0.83 | 54    | 0.75 | 23.75 |
| OUT-2466LAP | \$273 | 41 | 0.92 | 60    | 0.75 | 23.75 |
| OUT-2472LAP | \$293 | 45 | 1.0  | 65.75 | 0.75 | 23.75 |

- IF A FILLER IS REQUIRED, PLEASE **ADD A "-F"** TO THE END OF THE MODEL NUMBER, **Example:** OUT-2466LAP-F. THERE IS NO EXTRA CHARGE FOR FILLERS WHEN ORDERED W/ PANELS.

RTA

REFER PAGE OUT-13 FOR NEO-ANGLE WEDGE PANEL SET EXAMPLE LAYOUT

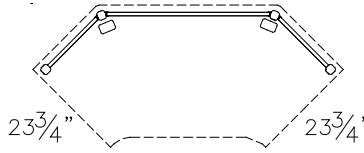
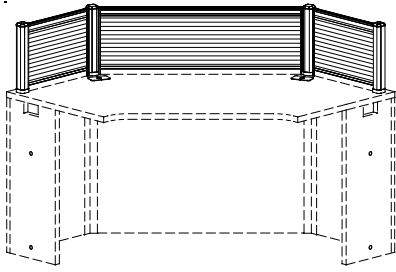

- TACK-BOARD, PLEXIGLASS & POLYCARBONATE CORNER PANEL SETS INCLUDE 3 PANELS AND 6 RAILS.
- LAMINATE FINISH CORNER PANEL SETS INCLUDE 3 PANELS.
- ORDER POSTS & TRANSACTION TOPS SEPARATELY.
- ALL MOUNTING HARDWARE INCLUDED

OUT-1248PYP-NAPS

| MODEL | LIST | WEIGHT | CUBE            | D  | H  |
|-------|------|--------|-----------------|----|----|
|       |      | LBS    | FT <sup>3</sup> | IN | IN |

NEO-ANGLE CORNER PANEL SETS

POLYCARBONATE FINISH

|                  |       |               |    |     |      |    |
|------------------|-------|---------------|----|-----|------|----|
| OUT-648PYP-NAPS  | \$712 | FITS 2448NACM | 7  | 0.3 | 0.75 | 6  |
| OUT-1248PYP-NAPS | \$719 | FITS 2448NACM | 13 | 0.6 | 0.75 | 12 |

- TOP & BOTTOM RAILS AVAILABLE IN BLACK (BL) OR ALUMINIUM (AL) FINISH. **PLEASE SPECIFY RAIL FINISH ON YOUR ORDER.**
- INCLUDES 3 PANELS & 6 RAILS



PLEXIGLASS FINISH

|                  |       |               |    |     |      |    |
|------------------|-------|---------------|----|-----|------|----|
| OUT-648PLX-NAPS  | \$834 | FITS 2448NACM | 14 | 0.3 | 0.75 | 6  |
| OUT-1248PLX-NAPS | \$847 | FITS 2448NACM | 29 | 0.6 | 0.75 | 12 |

- TOP & BOTTOM RAILS AVAILABLE IN BLACK (BL) OR ALUMINIUM (AL) FINISH. **PLEASE SPECIFY RAIL FINISH ON YOUR ORDER.**
- PLEXI PANELS ARE AVAILABLE IN CLEAR (CL), FROSTED (FR) OR BRONZE (BR). INDICATE YOUR CHOICE ON YOUR ORDER.
- INCLUDES 3 PANELS & 6 RAILS

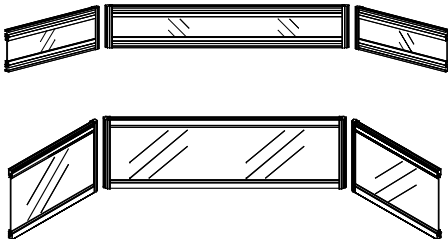

TACK BOARD FINISH

|                  |       |               |    |     |      |    |
|------------------|-------|---------------|----|-----|------|----|
| OUT-648TBP-NAPS  | \$841 | FITS 2448NACM | 10 | 0.3 | 0.75 | 6  |
| OUT-1248TBP-NAPS | \$860 | FITS 2448NACM | 21 | 0.6 | 0.75 | 12 |

- TOP & BOTTOM RAILS AVAILABLE IN BLACK (BL) OR ALUMINIUM (AL) FINISH. **PLEASE SPECIFY RAIL FINISH ON YOUR ORDER.**
- **FABRIC COLORS:** PLEASE REFER TO THE CURRENT HEARTWOOD FABRIC SAMPLE CARD OR THE FINISHES & FABRICS TAB ON THE [WWW.HEARTWOOD.CA](http://WWW.HEARTWOOD.CA) WEBSITE FOR A COMPLETE COLOUR CHOICE LISTING.
- INCLUDES 3 PANELS & 6 RAILS

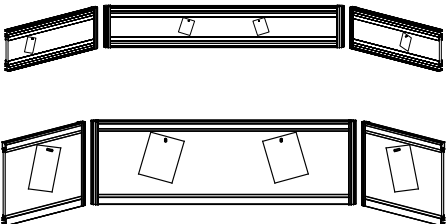

LAMINATE FINISH

|                  |       |               |    |     |      |    |
|------------------|-------|---------------|----|-----|------|----|
| OUT-648LAP-NAPS  | \$388 | FITS 2448NACM | 14 | 0.3 | 0.75 | 6  |
| OUT-1248LAP-NAPS | \$393 | FITS 2448NACM | 29 | 0.6 | 0.75 | 12 |

- TOP & BOTTOM EDGE PROTECTED W/ MATCHING 2MM EDGE BAND.
- INCLUDES 3 PANELS

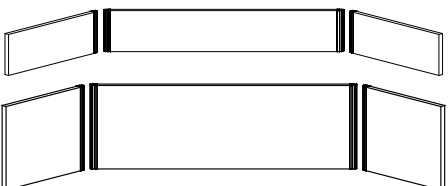

REFER PAGE OUT-13 FOR NEO-ANGLE CORNER PANEL SET EXAMPLE LAYOUT

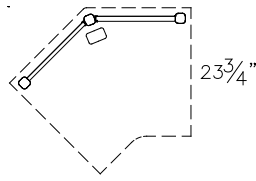
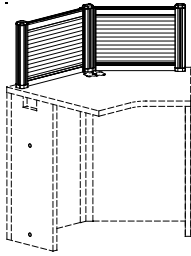

OUT-1224PYP-NAWPS

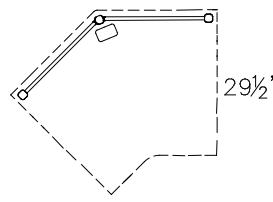

OUT-1230PYP-NAWPS

- TACK-BOARD, PLEXIGLASS & POLYCARBONATE NEO-ANGLE WEDGE PANEL SETS INCLUDE 2 PANELS AND 4 RAILS.
- LAMINATE FINISH NEO-ANGLE WEDGE PANEL SETS INCLUDE 2 PANELS.
- ORDER POSTS & TRANSACTION TOPS SEPARATELY.
- ALL MOUNTING HARDWARE INCLUDED

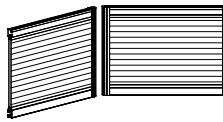

OUT-1224PYP-NAWPS

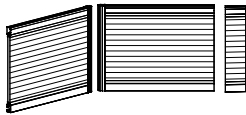

OUT-1224PYP-NAWPS-F

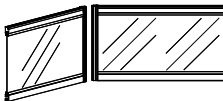

OUT-1224PLX-NAWPS

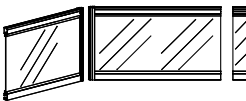

OUT-1224PLX-NAWPS-F

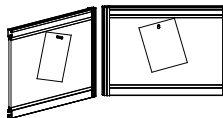

OUT-1224TBP-NAWPS

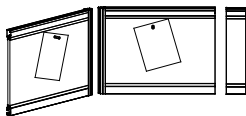

OUT-1224TBP-NAWPS-F

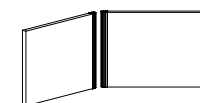

OUT-1224LAP-NAWPS

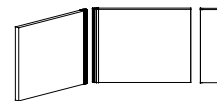

OUT-1224LAP-NAWPS-F

| MODEL | LIST | WEIGHT | CUBE            | D  | H  |
|-------|------|--------|-----------------|----|----|
|       |      | LBS    | FT <sup>3</sup> | IN | IN |

**NEO-ANGLE WEDGE PANEL SETS**

**POLYCARBONATE FINISH**

|                   |       |                   |   |     |      |    |
|-------------------|-------|-------------------|---|-----|------|----|
| OUT-1224PYP-NAWPS | \$505 | FITS 388-1224NACW | 7 | 0.3 | 0.75 | 12 |
| OUT-1230PYP-NAWPS | \$505 | FITS 388-1230NACW | 8 | 0.4 | 0.75 | 12 |

- TOP & BOTTOM RAILS AVAILABLE IN BLACK (BL) OR ALUMINIUM (AL) FINISH. **PLEASE SPECIFY RAIL FINISH ON YOUR ORDER.**
- STANDARD SET INCLUDES 2 PANELS & 4 RAILS
- IF A FILLER IS REQUIRED, PLEASE **ADD A "-F"** TO THE END OF THE MODEL NUMBER, **Example:** OUT-1224PYP-NAWPS-F. THERE IS NO EXTRA CHARGE FOR FILLERS WHEN ORDERED W/ PANELS.

**PLEXIGLASS FINISH**

|                   |       |                   |    |     |      |    |
|-------------------|-------|-------------------|----|-----|------|----|
| OUT-1224PLX-NAWPS | \$534 | FITS 388-1224NACW | 12 | 0.3 | 0.75 | 12 |
| OUT-1230PLX-NAWPS | \$534 | FITS 388-1230NACW | 14 | 0.4 | 0.75 | 12 |

- TOP & BOTTOM RAILS AVAILABLE IN BLACK (BL) OR ALUMINIUM (AL) FINISH. **PLEASE SPECIFY RAIL FINISH ON YOUR ORDER.**
- PLEXI PANELS ARE AVAILABLE IN CLEAR (CL), FROSTED (FR) OR BRONZE (BR). INDICATE YOUR CHOICE ON YOUR ORDER.
- STANDARD SET INCLUDES 2 PANELS & 4 RAILS
- IF A FILLER IS REQUIRED, PLEASE **ADD A "-F"** TO THE END OF THE MODEL NUMBER, **Example:** OUT-1224PLX-NAWPS-F. THERE IS NO EXTRA CHARGE FOR FILLERS WHEN ORDERED W/ PANELS.

**TACK BOARD FINISH**

|                   |       |                   |    |     |      |    |
|-------------------|-------|-------------------|----|-----|------|----|
| OUT-1224TBP-NAWPS | \$547 | FITS 388-1224NACW | 11 | 0.3 | 0.75 | 12 |
| OUT-1230TBP-NAWPS | \$547 | FITS 388-1230NACW | 13 | 0.4 | 0.75 | 12 |

- TOP & BOTTOM RAILS AVAILABLE IN BLACK (BL) OR ALUMINIUM (AL) FINISH. **PLEASE SPECIFY RAIL FINISH ON YOUR ORDER.**
- **FABRIC COLORS:** PLEASE REFER TO THE CURRENT HEARTWOOD FABRIC SAMPLE CARD OR THE FINISHES & FABRICS TAB ON THE [WWW.HEARTWOOD.CA](http://WWW.HEARTWOOD.CA) WEBSITE FOR A COMPLETE COLOUR CHOICE LISTING.
- STANDARD SET INCLUDES 2 PANELS & 4 RAILS
- IF A FILLER IS REQUIRED, PLEASE **ADD A "-F"** TO THE END OF THE MODEL NUMBER, **Example:** OUT-1224TBP-NAWPS-F. THERE IS NO EXTRA CHARGE FOR FILLERS WHEN ORDERED W/ PANELS.

**LAMINATE FINISH**

|                   |       |                   |    |     |      |    |
|-------------------|-------|-------------------|----|-----|------|----|
| OUT-1224LAP-NAWPS | \$264 | FITS 388-1224NACW | 15 | 0.3 | 0.75 | 12 |
| OUT-1230LAP-NAWPS | \$264 | FITS 388-1230NACW | 19 | 0.4 | 0.75 | 12 |

- TOP & BOTTOM EDGE PROTECTED W/ MATCHING 2MM EDGE BAND.
- STANDARD SET INCLUDES 2 PANELS
- IF A FILLER IS REQUIRED, PLEASE **ADD A "-F"** TO THE END OF THE MODEL NUMBER, **Example:** OUT-1224LAP-NAWPS-F. THERE IS NO EXTRA CHARGE FOR FILLERS WHEN ORDERED W/ PANELS.

RTA

**OUTLINES 1" & 1½" TOPS**  
**NEO-ANGLE TRANSACTION TOP**

**OUT1 = 1" (25MM) THICK TOP (FULL DETAILS SHOWN FOR ITEMS)**

**OUT2 = 1½" (36MM) THICK TOP W/ FLUTED EDGES**

NOTE: ONLY INFO SHOWN FOR OUT2 IS LIST PRICE- FOR ADDITIONAL INFO (ie. WEIGHT) CONTACT CUSTOMER SERVICE.

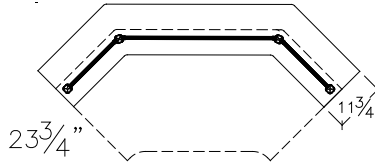
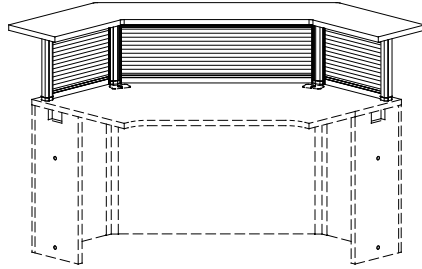
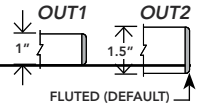

**OUT1-1248NATA**

- ALL END CORNERS ARE SQUARE. TO ORDER WITH 1 ½" RADIUS CORNERS, **ADD AN "R"** TO THE END OF THE PREFIX,
- **Example:** OUT1R-1248NATA AND AN UPCHARGE OF **\$80.**

| MODEL | LIST | LIST | WEIGHT | CUBE            | D  | H  |
|-------|------|------|--------|-----------------|----|----|
|       | OUT1 | OUT2 | LBS    | FT <sup>3</sup> | IN | IN |

**NEO-ANGLE CORNER TRANSACTION TOP**

FITS ON NEO-ANGLE CORNER PANEL SETS FOR 2448NACM

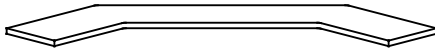

|               |       |       |    |   |    |   |
|---------------|-------|-------|----|---|----|---|
| OUT1-1248NATA | \$534 | \$633 | 35 | 1 | 12 | 1 |
|---------------|-------|-------|----|---|----|---|

**RTA**

**NEO-ANGLE WEDGE TRANSACTION TOP (NATAW)**

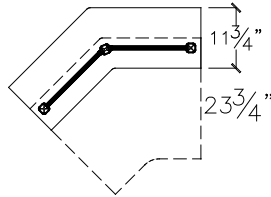
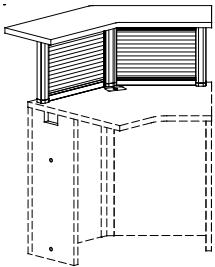

**OUT1-1224NATAW**

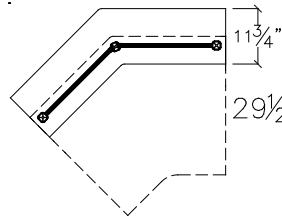

**OUT1-1230NATAW**

- ALL END CORNERS ARE SQUARE. TO ORDER WITH 1 ½" RADIUS CORNERS, **ADD AN "R"** TO THE END OF THE PREFIX,
- **Example:** OUT1R-1224NATAW AND AN UPCHARGE OF **\$80.**

| MODEL | LIST | LIST | WEIGHT | CUBE            | D  | H  |
|-------|------|------|--------|-----------------|----|----|
|       | OUT1 | OUT2 | LBS    | FT <sup>3</sup> | IN | IN |

**NEO-ANGLE WEDGE TRANSACTION TOPS**

FITS ON NEO-ANGLE WEDGE PANEL SETS FOR NEO-ANGLE CORNER WEDGES



|                |       |       |    |     |    |     |
|----------------|-------|-------|----|-----|----|-----|
| OUT1-1224NATAW | \$393 | \$462 | 18 | 0.8 | 12 | 1.5 |
| OUT1-1230NATAW | \$419 | \$491 | 20 | 0.8 | 12 | 1.5 |

**RTA**

**OUT1 = 1" (25MM) THICK TOP (FULL DETAILS SHOWN FOR ITEMS)**

**OUT2 = 1½" (36MM) THICK TOP W/ FLUTED EDGES**

NOTE: ONLY INFO SHOWN FOR OUT2 IS LIST PRICE- FOR ADDITIONAL INFO (ie. WEIGHT) CONTACT CUSTOMER SERVICE.

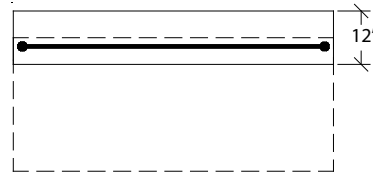
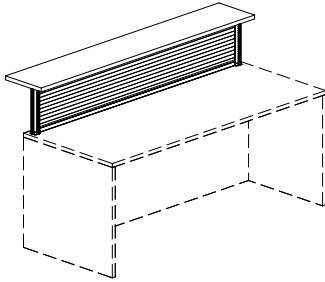
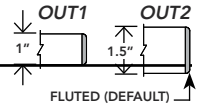

OUT1-1272TA

- ALL END CORNERS ARE SQUARE. TO ORDER WITH 1 ½" RADIUS CORNERS, **ADD AN "R"** TO THE END OF THE PREFIX,
- **Example:** OUT1R-1272TA AND AN UPCHARGE OF **\$80**.

| MODEL | LIST<br>OUT1 | LIST<br>OUT2 | WEIGHT<br>LBS | CUBE<br>FT <sup>3</sup> | W<br>IN | D<br>IN | H<br>IN |
|-------|--------------|--------------|---------------|-------------------------|---------|---------|---------|
|-------|--------------|--------------|---------------|-------------------------|---------|---------|---------|

**STRAIGHT TRANSACTION TOPS**

|             |       |       |    |     |       |    |   |
|-------------|-------|-------|----|-----|-------|----|---|
| OUT1-1224TA | \$137 | \$175 | 9  | 0.2 | 23.75 | 12 | 1 |
| OUT1-1230TA | \$166 | \$214 | 12 | 0.3 | 29.5  | 12 | 1 |
| OUT1-1236TA | \$179 | \$229 | 14 | 0.3 | 35.5  | 12 | 1 |
| OUT1-1242TA | \$223 | \$287 | 16 | 0.4 | 41.5  | 12 | 1 |
| OUT1-1248TA | \$234 | \$302 | 18 | 0.4 | 47.25 | 12 | 1 |
| OUT1-1254TA | \$277 | \$360 | 21 | 0.5 | 53.25 | 12 | 1 |
| OUT1-1260TA | \$290 | \$374 | 23 | 0.5 | 59.25 | 12 | 1 |
| OUT1-1266TA | \$331 | \$430 | 25 | 0.6 | 65    | 12 | 1 |
| OUT1-1272TA | \$345 | \$443 | 28 | 0.6 | 71    | 12 | 1 |

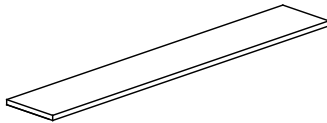

**RTA**

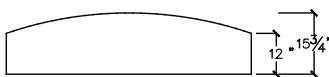
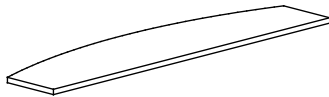

**BOW TRANSACTION TOPS**

|              |       |       |    |     |       |       |   |
|--------------|-------|-------|----|-----|-------|-------|---|
| OUT1-B1260TA | \$432 | \$516 | 27 | 0.7 | 59.25 | 15.75 | 1 |
| OUT1-B1266TA | \$473 | \$573 | 30 | 0.8 | 65    | 15.75 | 1 |
| OUT1-B1272TA | \$485 | \$586 | 33 | 0.8 | 71    | 15.75 | 1 |

**RTA**

# OUTLINES 1" + 1½" TOPS

## CORNER TRANSACTION TOPS

**OUT1 = 1" (25MM) THICK TOP (FULL DETAILS SHOWN FOR ITEMS)**

**OUT2 = 1½" (36MM) THICK TOP W/ FLUTED EDGES**

NOTE: ONLY INFO SHOWN FOR OUT2 IS LIST PRICE- FOR ADDITIONAL INFO (ie. WEIGHT) CONTACT CUSTOMER SERVICE.

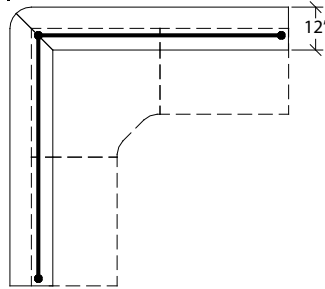
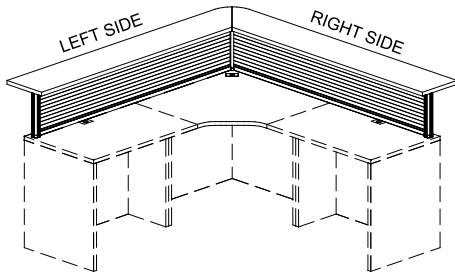
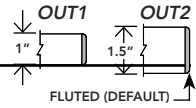

- ALL END CORNERS ARE SQUARE. TO ORDER WITH 1 ½" RADIUS CORNERS, **ADD AN "R"** TO THE END OF THE PREFIX,
- **Example:** OUT1R-1272CTA-L AND AN UPCHARGE OF **\$80**.
- **THE LEFT AND RIGHT SIDES ARE SEPARATE MODEL NUMBERS.**
- PLEASE BE SURE TO ORDER BOTH SIDES

| MODEL | LIST<br>OUT1 | LIST<br>OUT2 | WEIGHT<br>LBS | CUBE<br>FT <sup>3</sup> | W<br>IN | D<br>IN | H<br>IN |
|-------|--------------|--------------|---------------|-------------------------|---------|---------|---------|
|-------|--------------|--------------|---------------|-------------------------|---------|---------|---------|

### CORNER TRANSACTION TOP - LEFT

|                |       |       |    |     |       |    |   |
|----------------|-------|-------|----|-----|-------|----|---|
| OUT1-1224CTA-L | \$228 | \$296 | 12 | 0.3 | 28    | 12 | 1 |
| OUT1-1230CTA-L | \$249 | \$324 | 14 | 0.3 | 33.75 | 12 | 1 |
| OUT1-1236CTA-L | \$264 | \$339 | 16 | 0.4 | 39.75 | 12 | 1 |
| OUT1-1242CTA-L | \$311 | \$404 | 19 | 0.4 | 45.5  | 12 | 1 |
| OUT1-1248CTA-L | \$324 | \$418 | 21 | 0.5 | 51.5  | 12 | 1 |
| OUT1-1254CTA-L | \$345 | \$448 | 23 | 0.5 | 57.5  | 12 | 1 |
| OUT1-1260CTA-L | \$359 | \$462 | 24 | 0.5 | 63.25 | 12 | 1 |
| OUT1-1266CTA-L | \$419 | \$546 | 28 | 0.6 | 69.25 | 12 | 1 |
| OUT1-1272CTA-L | \$435 | \$561 | 30 | 0.7 | 75    | 12 | 1 |

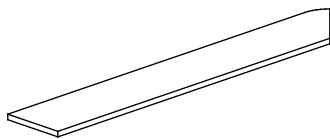

RTA

### CORNER TRANSACTION TOP - RIGHT

|                |       |       |    |     |       |    |   |
|----------------|-------|-------|----|-----|-------|----|---|
| OUT1-1224CTA-R | \$228 | \$296 | 12 | 0.3 | 28    | 12 | 1 |
| OUT1-1230CTA-R | \$249 | \$324 | 14 | 0.3 | 33.75 | 12 | 1 |
| OUT1-1236CTA-R | \$264 | \$339 | 16 | 0.4 | 39.75 | 12 | 1 |
| OUT1-1242CTA-R | \$311 | \$404 | 19 | 0.4 | 45.5  | 12 | 1 |
| OUT1-1248CTA-R | \$324 | \$418 | 21 | 0.5 | 51.5  | 12 | 1 |
| OUT1-1254CTA-R | \$345 | \$448 | 23 | 0.5 | 57.5  | 12 | 1 |
| OUT1-1260CTA-R | \$359 | \$462 | 24 | 0.5 | 63.25 | 12 | 1 |
| OUT1-1266CTA-R | \$419 | \$546 | 28 | 0.6 | 69.25 | 12 | 1 |
| OUT1-1272CTA-R | \$435 | \$561 | 30 | 0.7 | 75    | 12 | 1 |

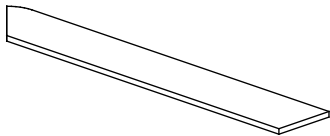

RTA

**OUT1 = 1" (25MM) THICK TOP (FULL DETAILS SHOWN FOR ITEMS)**

**OUT2 = 1½" (36MM) THICK TOP W/ FLUTED EDGES**

NOTE: ONLY INFO SHOWN FOR OUT2 IS LIST PRICE- FOR ADDITIONAL INFO (ie. WEIGHT) CONTACT CUSTOMER SERVICE.

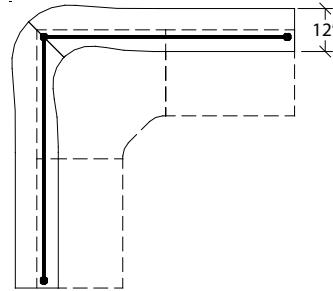
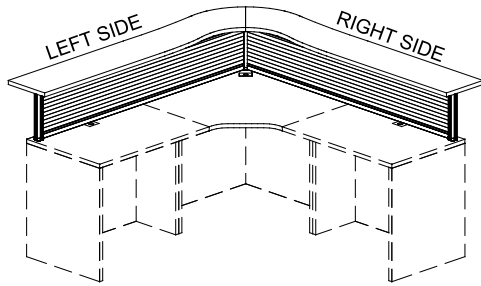
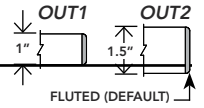

- ALL END CORNERS ARE SQUARE. TO ORDER WITH 1 ½" RADIUS CORNERS, **ADD AN "R"** TO THE END OF THE PREFIX,
- **Example:** OUT1R-1272SCTA-L AND AN UPCHARGE OF **\$80.**
- **THE LEFT AND RIGHT SIDES ARE SEPARATE MODEL NUMBERS.**
- PLEASE BE SURE TO ORDER BOTH SIDES

| MODEL | LIST<br>OUT1 | LIST<br>OUT2 | WEIGHT<br>LBS | CUBE<br>FT <sup>3</sup> | W<br>IN | D<br>IN | H<br>IN |
|-------|--------------|--------------|---------------|-------------------------|---------|---------|---------|
|-------|--------------|--------------|---------------|-------------------------|---------|---------|---------|

**SHAPED CORNER TRANSACTION TOP - LEFT**

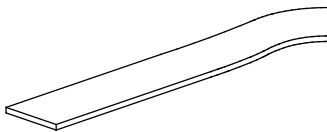

|                 |       |       |    |     |       |      |   |
|-----------------|-------|-------|----|-----|-------|------|---|
| OUT1-1236SCTA-L | \$313 | \$404 | 17 | 0.4 | 37.75 | 14.5 | 1 |
| OUT1-1242SCTA-L | \$345 | \$448 | 20 | 0.4 | 43.75 | 14.5 | 1 |
| OUT1-1248SCTA-L | \$359 | \$462 | 22 | 0.5 | 49.5  | 14.5 | 1 |
| OUT1-1254SCTA-L | \$377 | \$493 | 25 | 0.6 | 55.5  | 14.5 | 1 |
| OUT1-1260SCTA-L | \$394 | \$507 | 28 | 0.6 | 61.5  | 14.5 | 1 |
| OUT1-1266SCTA-L | \$454 | \$589 | 30 | 0.7 | 67.25 | 14.5 | 1 |
| OUT1-1272SCTA-L | \$469 | \$605 | 33 | 0.7 | 73.25 | 14.5 | 1 |

**RTA**

**SHAPED CORNER TRANSACTION TOP - RIGHT**

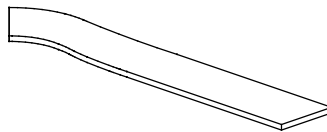

|                 |       |       |    |     |       |      |   |
|-----------------|-------|-------|----|-----|-------|------|---|
| OUT1-1236SCTA-R | \$313 | \$404 | 17 | 0.4 | 37.75 | 14.5 | 1 |
| OUT1-1242SCTA-R | \$345 | \$448 | 20 | 0.4 | 43.75 | 14.5 | 1 |
| OUT1-1248SCTA-R | \$359 | \$462 | 22 | 0.5 | 49.5  | 14.5 | 1 |
| OUT1-1254SCTA-R | \$377 | \$493 | 25 | 0.6 | 55.5  | 14.5 | 1 |
| OUT1-1260SCTA-R | \$394 | \$507 | 28 | 0.6 | 61.5  | 14.5 | 1 |
| OUT1-1266SCTA-R | \$454 | \$589 | 30 | 0.7 | 67.25 | 14.5 | 1 |
| OUT1-1272SCTA-R | \$469 | \$605 | 33 | 0.7 | 73.25 | 14.5 | 1 |

**RTA**

# OUTLINES 1" + 1½" HUTCHES

## OPEN HUTCH

**OUT1 = 1" (25MM) THICK TOP (FULL DETAILS SHOWN FOR ITEMS)**

**OUT2 = 1½" (36MM) THICK TOP W/ FLUTED EDGES**

NOTE: ONLY INFO SHOWN FOR OUT2 IS LIST PRICE- FOR ADDITIONAL INFO (ie. WEIGHT) CONTACT CUSTOMER SERVICE.

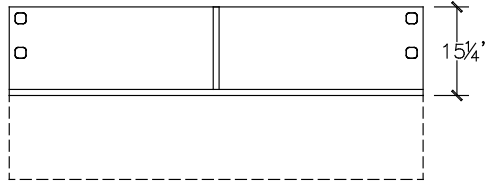
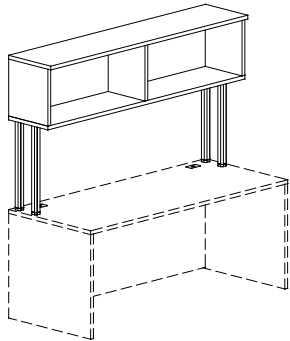
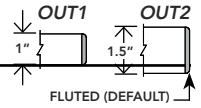

- ORDER STANDARD 24" PANELS IF A HUTCH BACK IS REQUIRED. CHOOSE FROM THE 4 STANDARD PANEL FINISHES.
- REFER PAGE **OUT-14** FOR LAMINATE PANELS.  
- **Example:** OUT-2472LAP.

| MODEL | LIST<br>OUT1 | LIST<br>OUT2 | WEIGHT<br>LBS | CUBE<br>FT <sup>3</sup> | W<br>IN | D<br>IN | H<br>IN |
|-------|--------------|--------------|---------------|-------------------------|---------|---------|---------|
|-------|--------------|--------------|---------------|-------------------------|---------|---------|---------|

### OPEN HUTCH (H)

|            |       |       |    |     |       |      |       |
|------------|-------|-------|----|-----|-------|------|-------|
| OUT1-4124H | \$704 | \$752 | 54 | 2   | 23.75 | 15.5 | 40.75 |
| OUT1-4130H | \$704 | \$752 | 58 | 2.2 | 29.5  | 15.5 | 40.75 |
| OUT1-4136H | \$770 | \$823 | 60 | 2.4 | 35.5  | 15.5 | 40.75 |
| OUT1-4142H | \$816 | \$875 | 68 | 2.6 | 41.5  | 15.5 | 40.75 |
| OUT1-4148H | \$886 | \$948 | 72 | 2.8 | 47.25 | 15.5 | 40.75 |

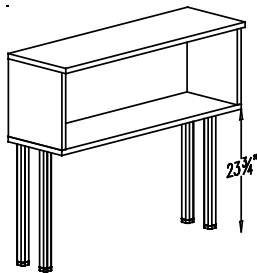

OUT1-4148H

### W/ DIVIDER

|            |         |         |    |     |       |      |       |
|------------|---------|---------|----|-----|-------|------|-------|
| OUT1-4154H | \$918   | \$983   | 76 | 3   | 53.25 | 15.5 | 40.75 |
| OUT1-4160H | \$984   | \$1,052 | 82 | 3.2 | 59.25 | 15.5 | 40.75 |
| OUT1-4166H | \$1,094 | \$1,248 | 87 | 3.4 | 65    | 15.5 | 40.75 |
| OUT1-4172H | \$1,177 | \$1,256 | 92 | 3.6 | 71    | 15.5 | 40.75 |

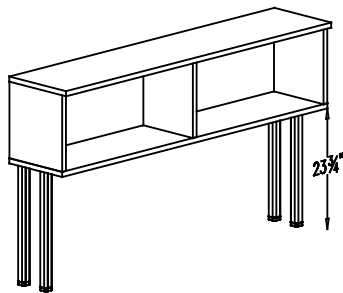

OUT1-4172H



**OUT1 = 1" (25MM) THICK TOP (FULL DETAILS SHOWN FOR ITEMS)**

**OUT2 = 1½" (36MM) THICK TOP W/ FLUTED EDGES**

NOTE: ONLY INFO SHOWN FOR OUT2 IS LIST PRICE- FOR ADDITIONAL INFO (ie. WEIGHT) CONTACT CUSTOMER SERVICE.

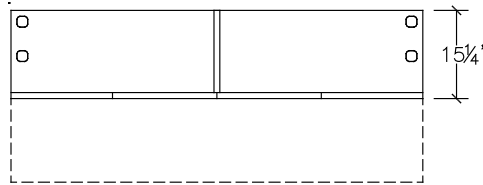
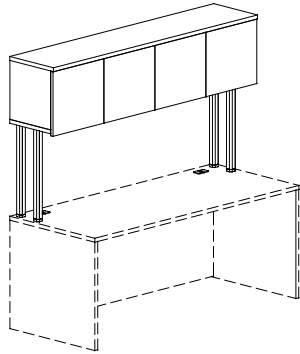
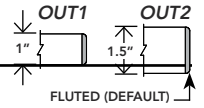

- ORDER STANDARD 24" PANELS IF A HUTCH BACK IS REQUIRED. CHOOSE FROM THE 4 STANDARD PANEL FINISHES.
- REFER PAGE **OUT-14** FOR LAMINATE PANELS.  
- **Example:** OUT-2472LAP.

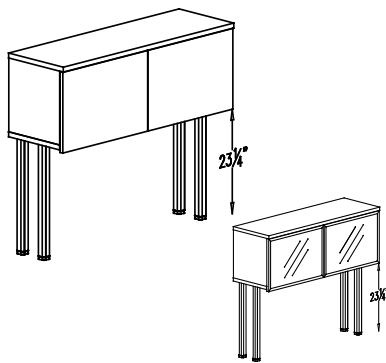

| MODEL | LIST | LIST | AGD UP | WEIGHT | CUBE            | W  | D  | H  |
|-------|------|------|--------|--------|-----------------|----|----|----|
|       | OUT1 | OUT2 | CHARGE | LBS    | FT <sup>3</sup> | IN | IN | IN |

**HUTCH W/ HINGED DOORS**

|              |         |         |       |     |     |       |      |       |
|--------------|---------|---------|-------|-----|-----|-------|------|-------|
| OUT1-4124HHD | \$985   | \$1,055 | \$420 | 67  | 2.4 | 23.75 | 15.5 | 40.75 |
| OUT1-4130HHD | \$985   | \$1,055 | \$420 | 75  | 2.7 | 29.5  | 15.5 | 40.75 |
| OUT1-4136HHD | \$1,050 | \$1,127 | \$466 | 81  | 3   | 35.5  | 15.5 | 40.75 |
| OUT1-4142HHD | \$1,099 | \$1,180 | \$513 | 93  | 3.3 | 41.5  | 15.5 | 40.75 |
| OUT1-4148HHD | \$1,166 | \$1,254 | \$532 | 101 | 3.6 | 47.25 | 15.5 | 40.75 |

**W/ DIVIDER**

|              |         |         |       |     |     |       |      |       |
|--------------|---------|---------|-------|-----|-----|-------|------|-------|
| OUT1-4154HHD | \$1,199 | \$1,292 | \$814 | 110 | 3.9 | 53.25 | 15.5 | 40.75 |
| OUT1-4160HHD | \$1,265 | \$1,363 | \$834 | 119 | 4.2 | 59.25 | 15.5 | 40.75 |
| OUT1-4166HHD | \$1,306 | \$1,409 | \$886 | 128 | 4.5 | 65    | 15.5 | 40.75 |
| OUT1-4172HHD | \$1,456 | \$1,574 | \$893 | 137 | 4.8 | 71    | 15.5 | 40.75 |

**\*\* OPTIONAL ALUMINUM GLAZED DOORS \*\***

- SELECT CLEAR (CL), FROSTED (FR) OR BRONZE (BR) PLEXI GLASS  
- **Example:** OUT1-4148HHD-AGD-FR
- TO LOCK HUTCH DOORS, **ADD AN "L"** TO ITEM # & ADD **\$76** TO RETAIL PRICE.  
- **Example:** OUT1-4148HHD-L
- HUTCH DOORS **DO NOT** REQUIRE HANDLES. TO ADD HANDLES PLEASE REFER TO PAGE **100-3**
- THE PRICE SHOWN FOR AGD DOORS IS AN UP-CHARGE THAT MUST BE ADDED TO THE BASE PRICE OF THE UNIT IT GOES ON.

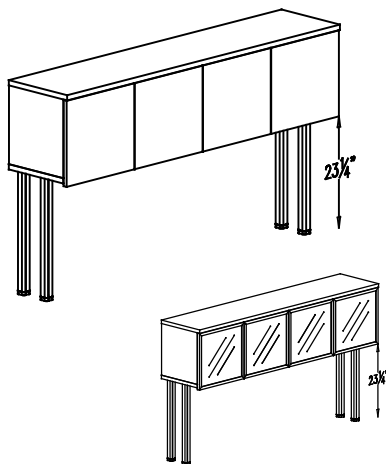

**RTA**

# OUTLINES 1" + 1½" HUTCHES

## HUTCH W/ FLIPPER DOORS

**OUT1 = 1" (25MM) THICK TOP (FULL DETAILS SHOWN FOR ITEMS)**

**OUT2 = 1½" (36MM) THICK TOP W/ FLUTED EDGES**

NOTE: ONLY INFO SHOWN FOR OUT2 IS LIST PRICE- FOR ADDITIONAL INFO (ie. WEIGHT) CONTACT CUSTOMER SERVICE.

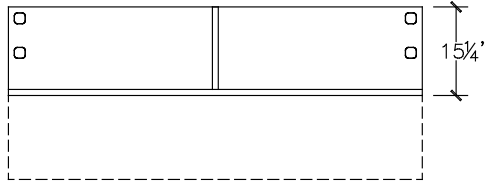
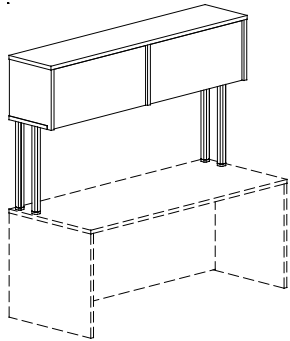
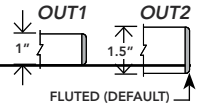

- ORDER STANDARD 24" PANELS IF A HUTCH BACK IS REQUIRED. CHOOSE FROM THE 4 STANDARD PANEL FINISHES.
- REFER PAGE [OUT-14](#) FOR LAMINATE PANELS.
- **Example:** OUT-2472LAP.

| MODEL | LIST<br>OUT1 | LIST<br>OUT2 | WEIGHT<br>LBS | CUBE<br>FT <sup>3</sup> | W<br>IN | D<br>IN | H<br>IN |
|-------|--------------|--------------|---------------|-------------------------|---------|---------|---------|
|-------|--------------|--------------|---------------|-------------------------|---------|---------|---------|

### HUTCH W/ FLIPPER DOORS

|              |         |         |     |     |       |      |       |
|--------------|---------|---------|-----|-----|-------|------|-------|
| OUT1-4124HFD | \$985   | \$1,055 | 67  | 2.4 | 23.75 | 15.5 | 40.75 |
| OUT1-4130HFD | \$985   | \$1,055 | 75  | 2.7 | 29.5  | 15.5 | 40.75 |
| OUT1-4136HFD | \$1,050 | \$1,127 | 81  | 3   | 35.5  | 15.5 | 40.75 |
| OUT1-4142HFD | \$1,099 | \$1,180 | 93  | 3.3 | 41.5  | 15.5 | 40.75 |
| OUT1-4148HFD | \$1,166 | \$1,254 | 101 | 3.6 | 47.25 | 15.5 | 40.75 |

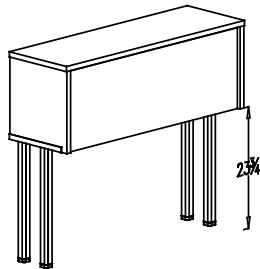

OUT1-4148HFD

### W/ DIVIDER

|              |         |         |     |     |       |      |       |
|--------------|---------|---------|-----|-----|-------|------|-------|
| OUT1-4154HFD | \$1,199 | \$1,292 | 110 | 3.9 | 53.25 | 15.5 | 40.75 |
| OUT1-4160HFD | \$1,265 | \$1,363 | 119 | 4.2 | 59.25 | 15.5 | 40.75 |
| OUT1-4166HFD | \$1,306 | \$1,409 | 128 | 4.5 | 65    | 15.5 | 40.75 |
| OUT1-4172HFD | \$1,456 | \$1,574 | 137 | 4.8 | 71    | 15.5 | 40.75 |

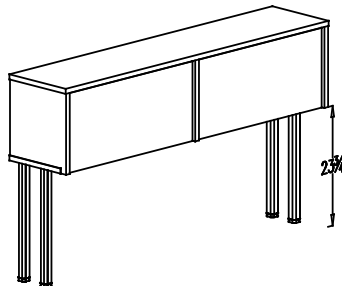

OUT1-4172HFD

- TO LOCK HUTCH DOORS, **ADD AN "L"** TO ITEM # & ADD **\$76** TO RETAIL PRICE.
- - **Example:** OUT1-4148HFD-L
- HUTCH DOORS **DO NOT** REQUIRE HANDLES. TO ADD HANDLES PLEASE REFER TO PAGE [100-3](#).

RTA

**OUT1 = 1" (25MM) THICK TOP (FULL DETAILS SHOWN FOR ITEMS)**

**OUT2 = 1½" (36MM) THICK TOP W/ FLUTED EDGES**

NOTE: ONLY INFO SHOWN FOR OUT2 IS LIST PRICE- FOR ADDITIONAL INFO (ie. WEIGHT) CONTACT CUSTOMER SERVICE.

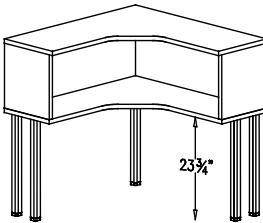
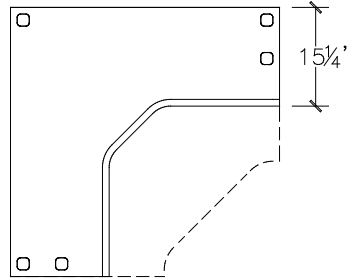
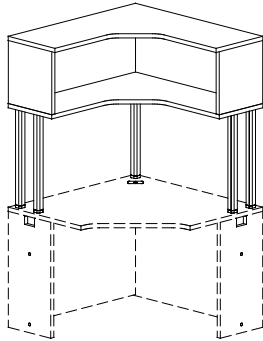
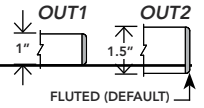

OUT1-4142CH

**RTA**

| MODEL | LIST<br>OUT1 | LIST<br>OUT2 | WEIGHT<br>LBS | CUBE<br>FT <sup>3</sup> | W<br>IN | D<br>IN | H<br>IN |
|-------|--------------|--------------|---------------|-------------------------|---------|---------|---------|
|-------|--------------|--------------|---------------|-------------------------|---------|---------|---------|

**OPEN CORNER HUTCH**

|             |         |         |     |     |           |      |       |
|-------------|---------|---------|-----|-----|-----------|------|-------|
| OUT1-4136CH | \$1,195 | \$1,314 | 121 | 4.5 | 35.5/35.5 | 15.5 | 40.75 |
| OUT1-4142CH | \$1,325 | \$1,455 | 148 | 5.5 | 41.5/41.5 | 15.5 | 40.75 |

**CORNER HUTCH W/ 2 HINGED DOORS**

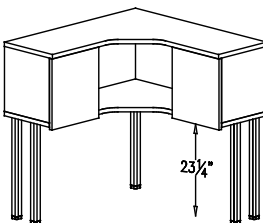
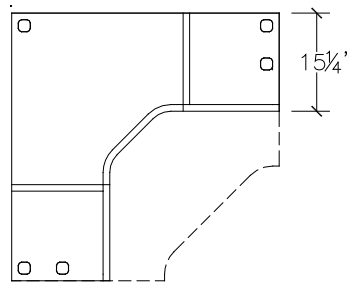
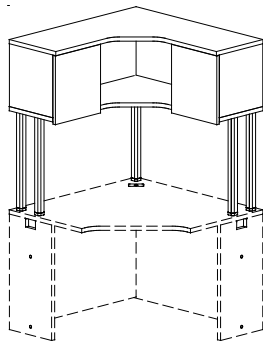

OUT1-4142CHHD

**RTA**

| MODEL | LIST<br>OUT1 | LIST<br>OUT2 | WEIGHT<br>LBS | CUBE<br>FT <sup>3</sup> | W<br>IN | D<br>IN | H<br>IN |
|-------|--------------|--------------|---------------|-------------------------|---------|---------|---------|
|-------|--------------|--------------|---------------|-------------------------|---------|---------|---------|

**CORNER HUTCH W/ 2 HINGED DOORS**

CENTRE SECTION IS OPEN

|               |         |         |     |   |           |      |       |
|---------------|---------|---------|-----|---|-----------|------|-------|
| OUT1-4136CHHD | \$1,518 | \$1,671 | 138 | 5 | 35.5/35.5 | 15.5 | 40.75 |
| OUT1-4142CHHD | \$1,647 | \$1,812 | 169 | 6 | 41.5/41.5 | 15.5 | 40.75 |

- TO LOCK HUTCH DOORS, **ADD AN "L"** TO ITEM # & ADD **\$76** TO RETAIL PRICE.  
- **Example:** OUT1-4142CHHD-**L**
- HUTCH DOORS **DO NOT** REQUIRE HANDLES. TO ADD HANDLES PLEASE REFER TO PAGE **100-3**.

# OUTLINES 1" + 1½" HUTCHES

## HUTCH FILLER PANELS

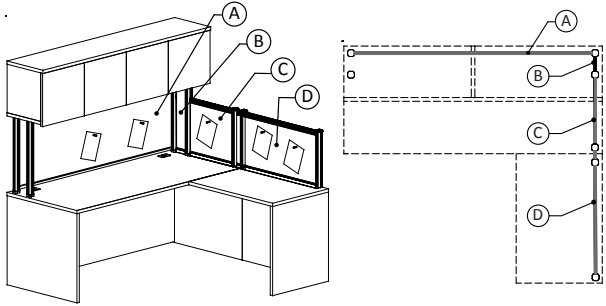

| ITEMS        | ITEM DESCRIPTION   | QTY | LIST           |
|--------------|--|-----|----------------|
|              | <b>OUT1-4172HHD</b> 41" HUTCH W/ HINGED LAMINATE DOORS       | 1 x | <b>\$1,456</b> |
| (A)          | <b>OUT-2472TBP</b> STANDARD TACK-BOARD PANEL                 | 1 x | <b>\$586</b>   |
| (B)          | <b>OUT-24TBP-HFP</b> HUTCH FILLER PANEL - TACK-BOARD (SEE A) | 1 x | <b>\$249</b>   |
| (C)          | <b>OUT-1824TBP</b> 18" TACK BOARD PANELS                     | 1 x | <b>\$285</b>   |
| (D)          | <b>OUT-1848TBP-F</b> STANDARD TACK-BOARD PANEL W/ FILLER     | 1 x | <b>\$377</b>   |
|              | <b>OUT-18POST</b> POST PACKAGES                              | 3 x | <b>\$113</b>   |
|              | <b>388-3072CT-A</b> 30" CONNECTOR TOP W/ A GABLE SET         | 1 x | <b>\$879</b>   |
|              | <b>388-2448RS</b> 24" NON-HANDED RETURN SHELL                | 1 x | <b>\$655</b>   |
| <b>TOTAL</b> |  |     | <b>\$4,555</b> |

**NOTE:** HUTCH FILLER PANELS FIT BETWEEN HUTCH SUPPORT POSTS (SEE B). IN COMBINATION WITH STANDARD PANELS (SEE C), A CONTINUOUS PRIVACY PANEL OR SUPPORT FOR TRANSACTION TOPS CAN BE CREATED.

- 24" DEEP WORK SURFACE USE 18" PANEL.
- 36" DEEP WORK SURFACE USE 30" PANEL
- \*\* 24" HIGH PANELS CAN ONLY CONNECT TO OPEN HUTCHES

| MODEL | LIST | WEIGHT | CUBE            | W  | D  | H  |
|-------|------|--------|-----------------|----|----|----|
|       |      | LBS    | FT <sup>3</sup> | IN | IN | IN |

### HUTCH FILLER PANELS

POLYCARBONATE HUTCH FILLER PANELS

|                      |              |   |      |      |      |       |
|----------------------|--------------|---|------|------|------|-------|
| <b>OUT-12PYP-HFP</b> | <b>\$178</b> | 1 | 0.03 | 4.75 | 0.75 | 12    |
| <b>OUT-18PYP-HFP</b> | <b>\$211</b> | 1 | 0.04 | 4.75 | 0.75 | 17.75 |
| <b>OUT-24PYP-HFP</b> | <b>\$240</b> | 1 | 0.05 | 4.75 | 0.75 | 23.75 |

- TOP & BOTTOM RAILS AVAILABLE IN BLACK (BL) OR ALUMINIUM (AL) FINISH. **PLEASE SPECIFY RAIL FINISH ON YOUR ORDER.**

PLEXIGLASS HUTCH FILLER PANELS

|                      |              |   |       |      |      |       |
|----------------------|--------------|---|-------|------|------|-------|
| <b>OUT-12PLX-HFP</b> | <b>\$196</b> | 2 | 0.035 | 4.75 | 0.75 | 12    |
| <b>OUT-18PLX-HFP</b> | <b>\$233</b> | 2 | 0.05  | 4.75 | 0.75 | 17.75 |
| <b>OUT-24PLX-HFP</b> | <b>\$265</b> | 3 | 0.07  | 4.75 | 0.75 | 23.75 |

- TOP & BOTTOM RAILS AVAILABLE IN BLACK (BL) OR ALUMINIUM (AL) FINISH. **PLEASE SPECIFY RAIL FINISH ON YOUR ORDER.**
- PLEXI PANELS ARE AVAILABLE IN CLEAR (CL), FROSTED (FR) OR BRONZE (BR). INDICATE YOUR CHOICE ON YOUR ORDER.

TACK BOARD HUTCH FILLER PANELS

|                      |              |   |      |      |      |       |
|----------------------|--------------|---|------|------|------|-------|
| <b>OUT-12TBP-HFP</b> | <b>\$227</b> | 1 | 0.03 | 4.75 | 0.75 | 12    |
| <b>OUT-18TBP-HFP</b> | <b>\$234</b> | 2 | 0.04 | 4.75 | 0.75 | 17.75 |
| <b>OUT-24TBP-HFP</b> | <b>\$249</b> | 2 | 0.05 | 4.75 | 0.75 | 23.75 |

- TOP & BOTTOM RAILS AVAILABLE IN BLACK (BL) OR ALUMINIUM (AL) FINISH. **PLEASE SPECIFY RAIL FINISH ON YOUR ORDER.**
- **FABRIC COLORS:** PLEASE REFER TO THE CURRENT HEARTWOOD FABRIC SAMPLE CARD OR THE FINISHES & FABRICS TAB ON THE [WWW.HEARTWOOD.CA](http://WWW.HEARTWOOD.CA) WEBSITE FOR A COMPLETE COLOUR CHOICE LISTING OR REFER TO THE CURRENT HEARTWOOD FABRIC SAMPLE CARD.

LAMINATE HUTCH FILLER PANELS

|                      |             |   |      |      |      |       |
|----------------------|-------------|---|------|------|------|-------|
| <b>OUT-12LAP-HFP</b> | <b>\$64</b> | 2 | 0.03 | 4.75 | 0.75 | 12    |
| <b>OUT-18LAP-HFP</b> | <b>\$78</b> | 3 | 0.04 | 4.75 | 0.75 | 17.75 |
| <b>OUT-24LAP-HFP</b> | <b>\$86</b> | 4 | 0.05 | 4.75 | 0.75 | 23.75 |

- TOP & BOTTOM EDGE PROTECTED W/ MATCHING 2MM EDGE BAND.

| MODEL | LIST | LIST | AGD UP | WEIGHT | CUBE                            | W  | D  | H  |
|-------|------|------|--------|--------|---------------------------------|----|----|----|
|       | OUT1 | OUT2 | CHARGE | LBS/KG | FT <sup>3</sup> /M <sup>3</sup> | IN | IN | IN |

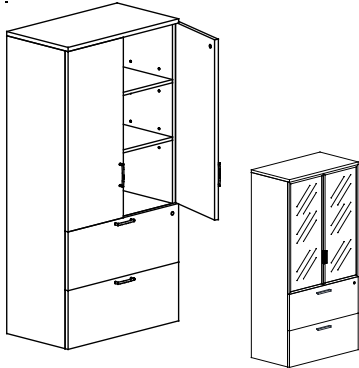

**TALL CABINET OVER LATERAL FILE**

20" DEEP. 1 FIXED SHELF & 2 ADJUSTABLE SHELVES. LOCKING CABINET & LATERAL FILE DRAWERS

|                 |         |         |       |     |    |      |       |       |
|-----------------|---------|---------|-------|-----|----|------|-------|-------|
| OUT1-7036CLF-20 | \$2,537 | \$2,678 | \$854 | 302 | 36 | 35.5 | 19.75 | 69.75 |
|-----------------|---------|---------|-------|-----|----|------|-------|-------|

**\*\* OPTIONAL ALUMINUM GLAZED DOORS \*\***

- SELECT CLEAR (CL), FROSTED (FR) OR BRONZE (BR) PLEXI GLASS  
- **Example:** OUT1-7036CLF-AGD-FR
- USE OUTLINES TALL CABINETS WHEN PLACING BESIDE OUTLINES HUTCHES. THIS ENSURES THE HEIGHTS WILL MATCH.
- AGD DOORS INCLUDE SILVER FINISH BAR HANDLES. FOR OTHER HANDLE SELECTION, PLEASE REFER TO PAGE [100-3](#).
- THE PRICE SHOWN FOR AGD DOORS IS AN UP-CHARGE THAT MUST BE ADDED TO THE BASE PRICE OF THE UNIT IT GOES ON.

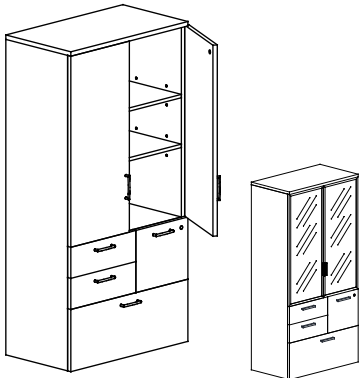

**TALL CABINET OVER COMBO LATERAL FILE**

20" DEEP. 1 FIXED SHELF & 2 ADJUSTABLE SHELVES. LOCKING CABINET, FILE & LATERAL FILE DRAWERS.

|                 |         |         |       |     |    |      |       |       |
|-----------------|---------|---------|-------|-----|----|------|-------|-------|
| OUT1-7036UFL-20 | \$2,660 | \$2,803 | \$854 | 302 | 36 | 35.5 | 19.75 | 69.75 |
|-----------------|---------|---------|-------|-----|----|------|-------|-------|

**\*\* OPTIONAL ALUMINUM GLAZED DOORS \*\***

- SELECT CLEAR (CL), FROSTED (FR) OR BRONZE (BR) PLEXI GLASS  
- **Example:** OUT1-7036UFL-AGD-FR
- USE OUTLINES TALL CABINETS WHEN PLACING BESIDE OUTLINES HUTCHES. THIS ENSURES THE HEIGHTS WILL MATCH.
- AGD DOORS INCLUDE SILVER FINISH BAR HANDLES. FOR OTHER HANDLE SELECTION, PLEASE REFER TO PAGE [100-3](#).
- THE PRICE SHOWN FOR AGD DOORS IS AN UP-CHARGE THAT MUST BE ADDED TO THE BASE PRICE OF THE UNIT IT GOES ON.

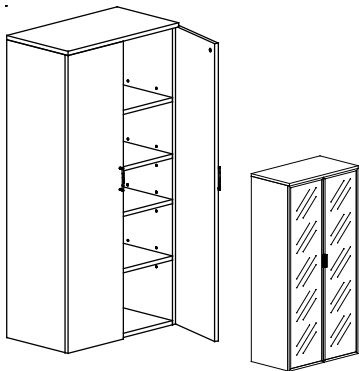

**TALL CABINET**

20" DEEP. 2 FIXED SHELVES & 3 ADJUSTABLE SHELVES. LOCKING CABINET

|               |         |         |         |     |    |      |       |       |
|---------------|---------|---------|---------|-----|----|------|-------|-------|
| OUT1-7036C-20 | \$2,268 | \$2,410 | \$1,215 | 330 | 36 | 35.5 | 19.75 | 69.75 |
|---------------|---------|---------|---------|-----|----|------|-------|-------|

**\*\* OPTIONAL ALUMINUM GLAZED DOORS \*\***

- SELECT CLEAR (CL), FROSTED (FR) OR BRONZE (BR) PLEXI GLASS  
- **Example:** OUT1-7036C-AGD-FR
- USE OUTLINES TALL CABINETS WHEN PLACING BESIDE OUTLINES HUTCHES. THIS ENSURES THE HEIGHTS WILL MATCH.
- AGD DOORS INCLUDE SILVER FINISH BAR HANDLES. FOR OTHER HANDLE SELECTION, PLEASE REFER TO PAGE [100-3](#).
- THE PRICE SHOWN FOR AGD DOORS IS AN UP-CHARGE THAT MUST BE ADDED TO THE BASE PRICE OF THE UNIT IT GOES ON.

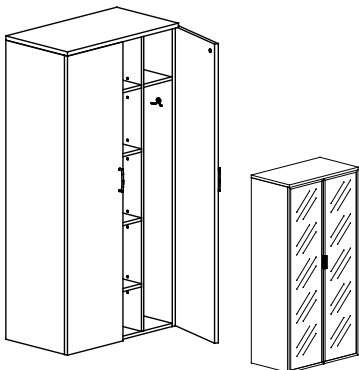

**TALL WARDROBE CABINET**

20" DEEP. 2 FIXED SHELVES & 3 ADJUSTABLE SHELVES. FULL HEIGHT WARDROBE W/ HAT SHELF & COAT HOOKS. LOCKING CABINET

|                |         |         |         |     |    |      |       |       |
|----------------|---------|---------|---------|-----|----|------|-------|-------|
| OUT1-7036WC-20 | \$2,485 | \$2,628 | \$1,215 | 320 | 36 | 35.5 | 19.75 | 69.75 |
|----------------|---------|---------|---------|-----|----|------|-------|-------|

**\*\* OPTIONAL ALUMINUM GLAZED DOORS \*\***

- SELECT CLEAR (CL), FROSTED (FR) OR BRONZE (BR) PLEXI GLASS  
- **Example:** OUT1-7036WC-AGD-FR
- USE OUTLINES TALL CABINETS WHEN PLACING BESIDE OUTLINES HUTCHES. THIS ENSURES THE HEIGHTS WILL MATCH.
- AGD DOORS INCLUDE SILVER FINISH BAR HANDLES. FOR OTHER HANDLE SELECTION, PLEASE REFER TO PAGE [100-3](#).
- THE PRICE SHOWN FOR AGD DOORS IS AN UP-CHARGE THAT MUST BE ADDED TO THE BASE PRICE OF THE UNIT IT GOES ON.

| MODEL | LIST | LIST | AGD UP | WEIGHT | CUBE                            | W  | D  | H  |
|-------|------|------|--------|--------|---------------------------------|----|----|----|
|       | OUT1 | OUT2 | CHARGE | LBS/KG | FT <sup>3</sup> /M <sup>3</sup> | IN | IN | IN |

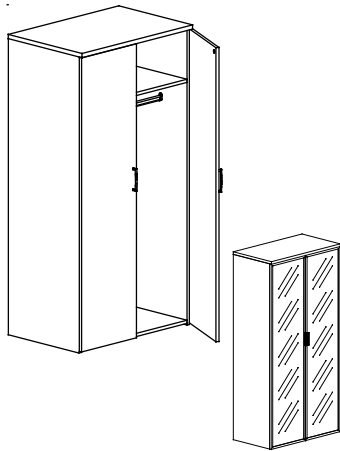

### DOUBLE DOOR CLOSET CABINET

24" DEEP. INCLUDES HAT SHELF AND COAT ROD. OPTIONAL BOOT SHELF (SEE BELOW). LOCKING CABINET.

|                 |         |         |         |     |    |      |       |       |
|-----------------|---------|---------|---------|-----|----|------|-------|-------|
| OUT1-7036CLC-24 | \$2,282 | \$2,426 | \$1,215 | 325 | 36 | 35.5 | 23.75 | 69.75 |
|-----------------|---------|---------|---------|-----|----|------|-------|-------|

#### \*\* OPTIONAL ALUMINUM GLAZED DOORS \*\*

- SELECT CLEAR (CL), FROSTED (FR) OR BRONZE (BR) PLEXI GLASS  
- **Example:** OUT1-7036CLC-AGD-**BR**
- USE OUTLINES TALL CABINETS WHEN PLACING BESIDE OUTLINES HUTCHES. THIS ENSURES THE HEIGHTS WILL MATCH.
- AGD DOORS INCLUDE SILVER FINISH BAR HANDLES. FOR OTHER HANDLE SELECTION, PLEASE REFER TO PAGE [100-3](#).
- THE PRICE SHOWN FOR AGD DOORS IS AN UP-CHARGE THAT MUST BE ADDED TO THE BASE PRICE OF THE UNIT IT GOES ON.

### SINGLE DOOR CLOSET CABINET

24" DEEP. INCLUDES HAT SHELF AND COAT ROD. OPTIONAL BOOT SHELF (SEE BELOW). LOCKING CABINET.

|                   |         |         |       |     |    |       |       |       |
|-------------------|---------|---------|-------|-----|----|-------|-------|-------|
| OUT1-7024CLC-L-24 | \$2,157 | \$2,299 | \$723 | 215 | 27 | 23.75 | 23.75 | 69.75 |
|-------------------|---------|---------|-------|-----|----|-------|-------|-------|

|                   |         |         |       |     |    |       |       |       |
|-------------------|---------|---------|-------|-----|----|-------|-------|-------|
| OUT1-7024CLC-R-24 | \$2,157 | \$2,299 | \$723 | 215 | 27 | 23.75 | 23.75 | 69.75 |
|-------------------|---------|---------|-------|-----|----|-------|-------|-------|

#### \*\* OPTIONAL ALUMINUM GLAZED DOORS \*\*

- SELECT CLEAR (CL), FROSTED (FR) OR BRONZE (BR) PLEXI GLASS  
- **Example:** OUT1-7024CLC-AGD-**BR**
- USE OUTLINES TALL CABINETS WHEN PLACING BESIDE OUTLINES HUTCHES. THIS ENSURES THE HEIGHTS WILL MATCH.
- AGD DOORS INCLUDE SILVER FINISH BAR HANDLES. FOR OTHER HANDLE SELECTION, PLEASE REFER TO PAGE [100-3](#).
- THE PRICE SHOWN FOR AGD DOORS IS AN UP-CHARGE THAT MUST BE ADDED TO THE BASE PRICE OF THE UNIT IT GOES ON.

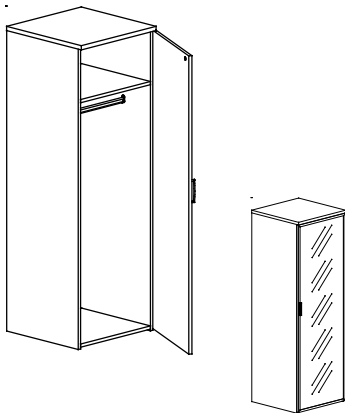

OUT1-7024CLC-R

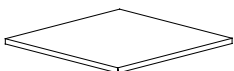
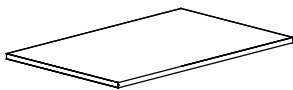

### OPTIONAL BOOT SHELVES

TALL WARDROBE STORAGE & STORAGE CABINETS CAN HAVE AN OPTIONAL BOOT SHELF. UPCHARGES APPLY WHEN ORDERING BOOT SHELF: **ADD -BS** TO PRODUCT SKU.

> **ORDERING Example:** 388-4724CWR-24-**BS**

**SEE PAGE [OUT-7](#)**

| MODEL | LIST | LIST | AGD UP | WEIGHT | CUBE                            | W  | D  | H  |
|-------|------|------|--------|--------|---------------------------------|----|----|----|
|       | OUT1 | OUT2 | CHARGE | LBS/KG | FT <sup>3</sup> /M <sup>3</sup> | IN | IN | IN |

**WARDROBE STORAGE**

INCLUDES HAT SHELF AND COAT ROD. 1 FIXED SHELF & 2 ADJUSTABLE SHELVES IN STORAGE CABINET. LOCKING CABINETS & DRAWERS.

|                   |                |                |                |     |    |       |       |       |
|-------------------|----------------|----------------|----------------|-----|----|-------|-------|-------|
| OUT1-7024CUFWL-24 | <b>\$2,378</b> | <b>\$2,703</b> | <b>\$1,188</b> | 260 | 27 | 23.75 | 23.75 | 69.75 |
| OUT1-7024CUFWR-24 | <b>\$2,378</b> | <b>\$2,703</b> | <b>\$1,188</b> | 260 | 27 | 23.75 | 23.75 | 69.75 |

**\*\* OPTIONAL ALUMINUM GLAZED DOORS \*\***

- SELECT CLEAR (CL), FROSTED (FR) OR BRONZE (BR) PLEXI GLASS  
 - **Example:** OUT1-7024UFWR-AGD-CL
- USE OUTLINES TALL CABINETS WHEN PLACING BESIDE OUTLINES HUTCHES. THIS ENSURES THE HEIGHTS WILL MATCH.
- AGD DOORS INCLUDE SILVER FINISH BAR HANDLES. FOR OTHER HANDLE SELECTION, PLEASE REFER TO PAGE **100-3**
- THE PRICE SHOWN FOR AGD DOORS IS AN UP-CHARGE THAT MUST BE ADDED TO THE BASE PRICE OF THE UNIT IT GOES ON.

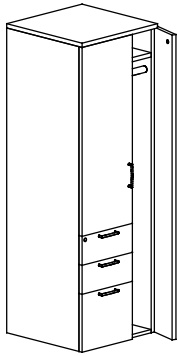

OUT1-7024UFWR



| ITEMS | ITEM DESCRIPTION | QTY | LIST |
|-------|------------------|-----|------|
|-------|------------------|-----|------|

### LAYOUT 1 - NEO-ANGLE WEDGE PANEL SET

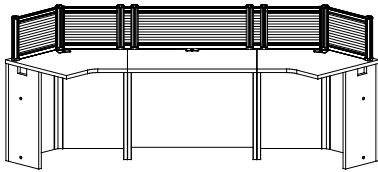

|                            |   |     |                |
|----------------------------|---|-----|----------------|
| <b>388-2424NACW</b>        | NEO-ANGLE CORNER WEDGE                    | 2 x | <b>\$896</b>   |
| <b>388-2436CT-C</b>        | 24" NON-HANDED CONNECTOR TOP              |     | <b>\$615</b>   |
| <b>OUT-12POST</b>          | OUTLINES POST PACKAGE                     | 8 x | <b>\$94</b>    |
| <b>OUT-1236PYP</b>         | 12" POLYCARBONATE PANELS                  |     | <b>\$289</b>   |
| <b>OUT-1224PYP-NAWPS-F</b> | NEO-ANGLE WEDGE PANEL SET W/ FILLER PANEL | 2 x | <b>\$505</b>   |
| <b>TOTAL</b>               |   |     | <b>\$4,458</b> |

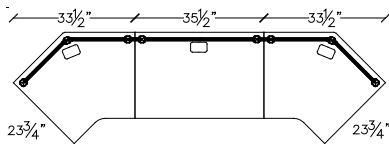

### LAYOUT 2 - NEO-ANGLE CORNER PANEL SET

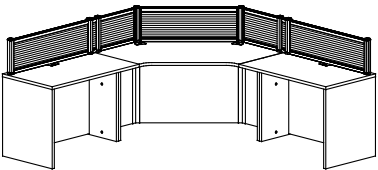

|                         |                                       |     |                |
|-------------------------|---------------------------------------|-----|----------------|
| <b>388-2448NACM</b>     | NEO-ANGLE CORNER MODULE               |     | <b>\$1,325</b> |
| <b>388-2442CT-B</b>     | 24" NON-HANDED CONNECTOR TOP          | 2 x | <b>\$638</b>   |
| <b>OUT-12POST</b>       | OUTLINES POST PACKAGE                 | 8 x | <b>\$94</b>    |
| <b>OUT-1242PYP-F</b>    | 12" POLYCARBONATE PANELS              | 2 x | <b>\$323</b>   |
| <b>OUT-1248PYP-NAPS</b> | 12" POLYCARBONATE NEO-ANGLE PANEL SET |     | <b>\$719</b>   |
| <b>TOTAL</b>            |                                       |     | <b>\$4,718</b> |

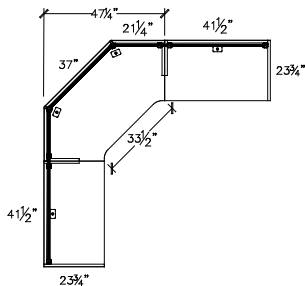

### LAYOUT 3

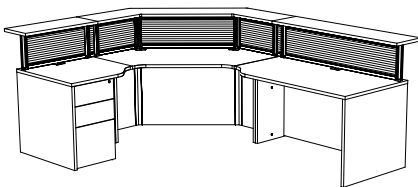

|                         |                                       |     |                |
|-------------------------|---------------------------------------|-----|----------------|
| <b>388-3030LC-CR</b>    | 30" LEFT CONNECTOR, CUTBACK RIGHT     |     | <b>\$683</b>   |
| <b>388-2448NACM</b>     | NEO-ANGLE CORNER MODULE               |     | <b>\$1,325</b> |
| <b>388-3054RC-CL</b>    | 30" RIGHT CONNECTOR, CUTBACK LEFT     |     | <b>\$814</b>   |
| <b>388-19FPUFX</b>      | FREESTANDING PEDESTAL - NO TOP        |     | <b>\$871</b>   |
| <b>OUT-12POST</b>       | OUTLINES POST PACKAGE                 | 8 x | <b>\$94</b>    |
| <b>OUT-1230PYP-F</b>    | 12" POLYCARBONATE PANEL               |     | <b>\$240</b>   |
| <b>OUT-1254PYP-F</b>    | 12" POLYCARBONATE PANEL               |     | <b>\$414</b>   |
| <b>OUT-1248PYP-NAPS</b> | 12" POLYCARBONATE NEO-ANGLE PANEL SET |     | <b>\$719</b>   |
| <b>OUT1-1254TA</b>      | TRANSACTION TOP                       |     | <b>\$277</b>   |
| <b>OUT1-1248NATA</b>    | NEO ANGLE TRANSACTION TOP             |     | <b>\$534</b>   |
| <b>OUT1-1230TA</b>      | TRANSACTION TOP                       |     | <b>\$166</b>   |
| <b>TOTAL</b>            |                                       |     | <b>\$6,795</b> |

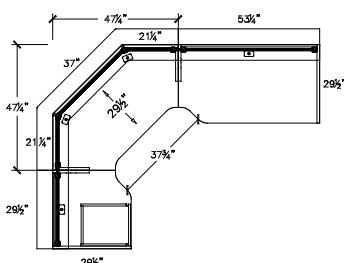



| ITEMS               | ITEM DESCRIPTION                    | QTY  | LIST           |
|---------------------|-------------------------------------|------|----------------|
| <b>LAYOUT 4</b>     |                                     |      |                |
| 388-2424NACW        | NEO ANGLE CORNER WEDGE              | 2 x  | \$896          |
| 388-3036LC-CR       | LEFT CONNECTOR, CUTBACK RIGHT       |      | \$717          |
| 388-3042RC-CL       | RIGHT CONNECTOR, CUTBACK LEFT       |      | \$745          |
| 388-19FPUFX         | FREE STANDING PEDESTAL              |      | \$871          |
| 388-2436BR          | 24" BRIDGE RETURN                   |      | \$543          |
| OUT-1224PYP-NAWPS-F | NEO ANGLE WEDGE PANEL SET W/ FILLER | 2 x  | \$505          |
| OUT-1236PYP         | 12" POLYCARBONATE PANEL             | 2 x  | \$289          |
| OUT-1242PYP         | 12" POLYCARBONATE PANEL             |      | \$323          |
| OUT-12POST          | OUTLINES POST PACKAGE               | 12 x | \$94           |
| <b>TOTAL</b>        |                                     |      | <b>\$7,707</b> |

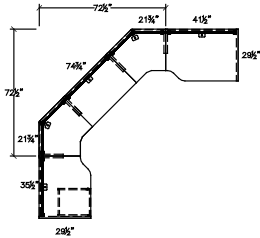
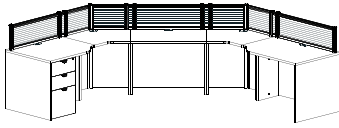

|                     |                                     |      |                |
|---------------------|-------------------------------------|------|----------------|
| <b>LAYOUT 5</b>     |                                     |      |                |
| 388-3030NACW        | NEO ANGLE CORNER WEDGE              | 2 x  | \$1,059        |
| 388-3036CT-C        | 30" CONNECTOR TOP                   |      | \$683          |
| 388-3042CT-B        | 30" CONNECTOR TOP                   |      | \$711          |
| 388-3036CT-B        | 30" CONNECTOR TOP                   |      | \$683          |
| 388-1627MPUF        | MOBILE PEDESTAL                     |      | \$965          |
| OUT-1230PYP-NAWPS-F | NEO ANGLE WEDGE PANEL SET W/ FILLER | 2 x  | \$505          |
| OUT-1236PYP         | 12" POLYCARBONATE PANEL             | 2 x  | \$289          |
| OUT-1242PYP         | 12" POLYCARBONATE PANEL             |      | \$323          |
| OUT1-1230NATAW      | NEO ANGLE WEDGE TRANSACTION         | 2 x  | \$419          |
| OUT1-1236TA         | STRAIGHT TRANSACTION TOP            | 2 x  | \$179          |
| OUT1-1242TA         | STRAIGHT TRANSACTION TOP            |      | \$223          |
| OUT-12POST          | OUTLINES POST PACKAGE               | 12 x | \$94           |
| <b>TOTAL</b>        |                                     |      | <b>\$9,618</b> |

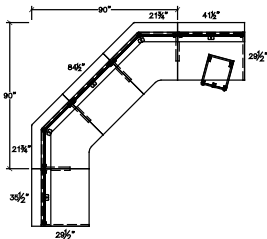
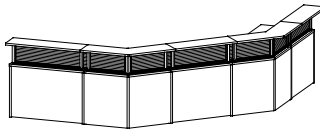
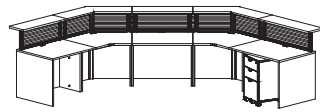

|   |                                   |     |                 |
|---|-----------------------------------|-----|-----------------|
| <b>LAYOUT #6 (SHOWN IN 600 SERIES BROCHURE)</b> |                                   |     |                 |
| 600-8442RCMBTM5                                 | CORNER MODULE BULLET W/ 5" LEG    |     | \$2,417         |
| 600-2448CT-C                                    | 24" CONNECTOR TOP W/ C GABLES     |     | \$766           |
| 600-2472UF                                      | SINGLE RIGHT PEDESTAL CREDENZA    |     | \$1,916         |
| 600-1872OSFD                                    | OVERHEAD STORAGE - FLIPPER DOOR   |     | \$1,436         |
| 600-7216COF-R-24                                | STORAGE CABINET                   |     | \$1,650         |
| 388-1836DTO                                     | DESKTOP ORGANIZER                 |     | \$603           |
| OUT-1824TBP-F                                   | 18" TACK-BOARD PANEL W/ FILLER    |     | \$285           |
| OUT-1848PYP-F                                   | 18" POLYCARBONATE PANEL W/ FILLER |     | \$435           |
| OUT-1242PYP                                     | 12" POLYCARBONATE PANEL           |     | \$323           |
| OUT-18POST                                      | POST PACKAGES                     | 5 x | \$113           |
| OUT-12POST                                      | OUTLINES POST PACKAGE             |     | \$94            |
| <b>TOTAL</b>                                    |                                   |     | <b>\$10,490</b> |

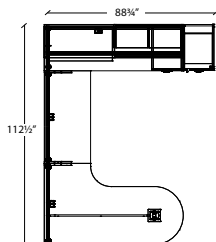
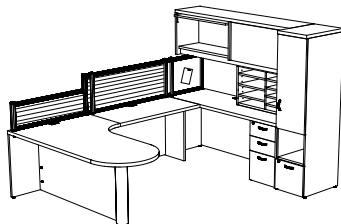

\* IMAGE SHOWS OPTIONAL VALENCE. ADD -V TO SKU AND \$218 TO PRICE IF VALENCE IS REQUIRED

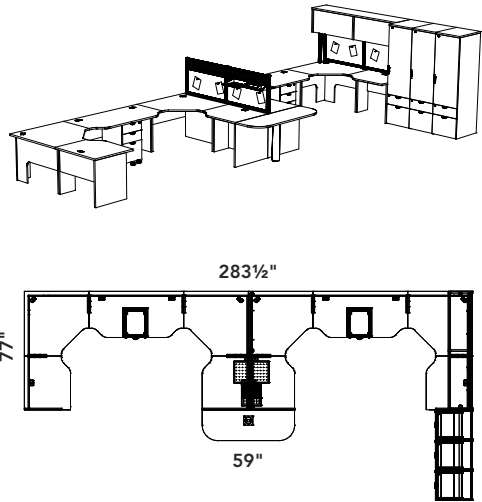

| ITEMS   | ITEM DESCRIPTION                                       | QTY | LIST            |
|---|--|-----|-----------------|
| <b>LAYOUT #7 (SHOWN IN 388 SERIES BROCHURE)</b> |  |     |                 |
| 388-R3036LC-CR-B2                               | RECESSED 30" LT CONNECTOR, CUTBACK RT W/ 1/2 HEIGHT MP |     | \$717           |
| 388-R2442CM-C2                                  | RECESSED CORNER MODULE W/ 1/2 HEIGHT MP                | 2 X | \$973           |
| OUT1-4178HFD                                    |  |     | \$1,830         |
| OUT-2478TBP                                     | 24" OUTLINES TACK BOARD PANEL (HUTCH)                  |     | \$663           |
| 388-R3060CC-CD-C2                               | RECESSED 30" CENTER CONNECTOR, CUTBACK DBLE            | 2 X | \$868           |
| 388-RF2442CM-C4                                 | CORNER MODULE W/ 1/2 HEIGHT RECESSED LT HAND MP        |     | \$973           |
| 388-3036RC-CL-B2                                | 30" RIGHT CONNECTOR, CUTBACK LEFT                      |     | \$717           |
| 388-3036LC-CR-B2                                | 30" LEFT CONNECTOR, CUTBACK RIGHT                      |     | \$717           |
| 388-FR2442CM-C6                                 | CORNER MODULE W/ 1/2 HEIGHT RECESSED RT H& MP          |     | \$973           |
| 388-R3036RC-CL-B2                               | RECESSED 30" RT CONNECTOR, CUTBACK LT W/ 1/2 HEIGHT MP |     | \$717           |
| COUT1-7020CF-R-24                               | TALL STORAGE, CABINET BOX/FILE - HINGED RT             | 3 X | \$1,840         |
| C910-REC6020                                    | CUSTOM RECTANGLE TOP                                   |     | \$613           |
| 900-RL5   | 4 3/4" ROUND LEG                                       |     | \$163           |
| 388-1627MPUF                                    | MOBILE PEDESTAL  | 2 X | \$965           |
| OUT-24POST                                      | 24" OUTLINES POST PACKAGE                              | 3 X | \$158           |
| OUT-1878TBP                                     | OUTLINES 18" TACK BOARD PANEL                          |     | \$641           |
| COUT-678PYP                                     | CUSTOM 6" POLYCARBONATE PANEL                          |     | \$538           |
| OUT-LTRPRT                                      | LETTER TRAY - PORTRAIT                                 | 2 X | \$68            |
| OUT-ACCTRY                                      | ACCESSORY TRAY   | 2 X | \$59            |
| WRK-WABK  | WORK SURFACE ANGLE BRACKET KIT                         |     | \$40            |
| <b>TOTAL</b>                                    |  |     | <b>\$21,162</b> |

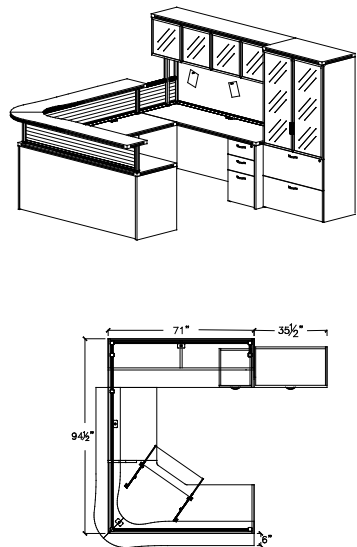

|                     |                                    |     |                 |
|---------------------|------------------------------------|-----|-----------------|
| <b>LAYOUT #8</b>    |                                    |     |                 |
| OUT2-1272SCTA-L     | SHAPED CORNER TRANSACTION TOP- LT  |     | \$605           |
| OUT2-1272SCTA-R     | SHAPED CORNER TRANSACTION TOP- RT  |     | \$605           |
| 600-7236CM-B        | EXTENDED CORNER MODULE LEFT        |     | \$1,332         |
| 600-2436BR          | BRIDGE RETURN                      |     | \$619           |
| 600-2472CT-A        | 24" CONNECTOR TOP W/ A GABLES      |     | \$913           |
| OUT2-7036CLF-20-AGD | TALL CABINET OVER LATERAL FILE     |     | \$2,678         |
|                     | <i>AGD UP-CHARGE</i>               |     | \$854           |
| OUT2-4172HHD-AGD    | HUTCH W/ ALUMINUM GLASS DOORS      |     | \$1,574         |
|                     | <i>AGD UP-CHARGE</i>               |     | \$893           |
| OUT-1272PYP         | 12" POLYCARBONATE PANEL            | 2 x | \$545           |
| OUT-12POST          | OUTLINES POST PACKAGE              | 4 x | \$94            |
| OUT-1218PYP-F       | 12" POLYCARBONATE PANELS W/ FILLER |     | \$206           |
| OUT-2472TBP         | 24" TACK-BOARD PANEL               |     | \$586           |
| OUT-12PYP-HFP       | POLYCARBONATE HUTCH FILLER PANEL   |     | \$178           |
| 600-19FPUFX         | FREESTANDING PEDESTAL - NO TOP     |     | \$871           |
| 100-KD28            | KEYBOARD DRAWER                    |     | \$202           |
| <b>TOTAL</b>        |                                    |     | <b>\$13,582</b> |

| ITEMS            | ITEM DESCRIPTION                      | QTY | LIST            |
|------------------|---------------------------------------|-----|-----------------|
| <b>LAYOUT #9</b> |                                       |     |                 |
| 850-6636CM       | LEFT EXTENDED CORNER MODULE           |     | <b>\$899</b>    |
| 850-2430CC       | 24" CENTER CONNECTOR                  | 2 X | <b>\$465</b>    |
| 850-3066BTGM-C   | CENTER BULLET TOP W/ MODESTY          |     | <b>\$911</b>    |
| 850-2436CM       | CORNER MODULE                         |     | <b>\$671</b>    |
| 850-2430RC       | RIGHT CONNECTOR                       |     | <b>\$465</b>    |
| 850-4166HHD      | HUTCH W/ HINGED DOORS                 |     | <b>\$1,056</b>  |
| 850-4160HHD      | HUTCH W/ HINGED DOORS                 |     | <b>\$1,032</b>  |
| 850-4136CH       | CORNER HUTCH / 41" HIGH               |     | <b>\$888</b>    |
| 850-4130HHD      | HUTCH W/ HINGED DOORS                 |     | <b>\$682</b>    |
| 850-MPUF         | MOBILE BBF PED                        | 2 X | <b>\$965</b>    |
| OUT-12POST       | OUTLINES POST PACKAGE                 | 2 X | <b>\$94</b>     |
| OUT-1236PYP      | 12" X 36" POLYCARBONATE PANEL W/RAILS |     | <b>\$289</b>    |
| OUT1-1248ETA     | ELLIPTICAL TRANSACTION TOP            |     | <b>\$453</b>    |
| <b>TOTAL</b>     |                                       |     | <b>\$10,394</b> |

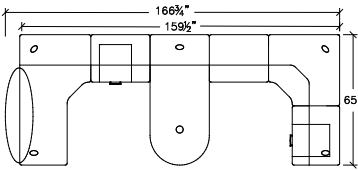
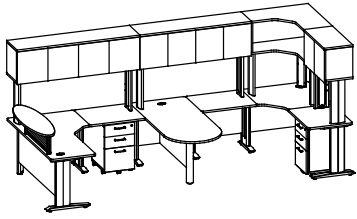

|                   |                                       |     |                |
|-------------------|---------------------------------------|-----|----------------|
| <b>LAYOUT #10</b> |                                       |     |                |
| 850-2430EMT-L     | END MEETING TABLE LEFT                |     | <b>\$474</b>   |
| 850-2436LC        | LEFT CONNECTOR                        |     | <b>\$497</b>   |
| 850-2442CM        | CORNER MODULE                         |     | <b>\$784</b>   |
| 850-2430RC        | RIGHT CONNECTOR                       |     | <b>\$465</b>   |
| 850-4142CH        | CORNER HUTCH / 41" HIGH               |     | <b>\$993</b>   |
| 850-4130HHD       | HUTCH W/ HINGED DOORS                 |     | <b>\$682</b>   |
| 850-42CHB         | 42" CORNER HUTCH BACK - ONE SIDE ONLY |     | <b>\$175</b>   |
| 850-42CTB         | CORNER TACK-BOARD - ONE SIDE ONLY     |     | <b>\$325</b>   |
| 850-MPUF          | MOBILE BBF PED                        |     | <b>\$965</b>   |
| OUT1-1236TA       | TRANSACTION TOP                       |     | <b>\$179</b>   |
| OUT-12POST        | OUTLINES POST PACKAGE                 | 2 X | <b>\$94</b>    |
| OUT-1236PYP       | 12" X 36" POLYCARBONATE PANEL W/RAILS |     | <b>\$289</b>   |
| <b>TOTAL</b>      |                                       |     | <b>\$6,016</b> |

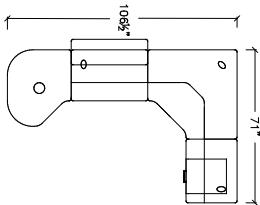
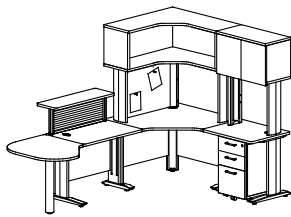

|                   |                                       |     |                |
|-------------------|---------------------------------------|-----|----------------|
| <b>LAYOUT #11</b> |                                       |     |                |
| 850-2436LC        | LEFT CONNECTOR                        |     | <b>\$497</b>   |
| 850-2436CM        | CORNER MODULE                         |     | <b>\$671</b>   |
| 850-2436RC        | RIGHT CONNECTOR                       |     | <b>\$497</b>   |
| 850-MPUF          | MOBILE BBF PED                        |     | <b>\$965</b>   |
| OUT-12POST        | OUTLINES POST PACKAGE                 | 3 X | <b>\$94</b>    |
| OUT-1272PYP       | POLYCARBONATE PANEL                   | 2 X | <b>\$545</b>   |
| OUT1-1272SCTA-L   | SHAPED CORNER TRANSACTION TOP - LEFT  |     | <b>\$469</b>   |
| OUT1-1272SCTA-R   | SHAPED CORNER TRANSACTION TOP - RIGHT |     | <b>\$469</b>   |
| <b>TOTAL</b>      |                                       |     | <b>\$4,940</b> |

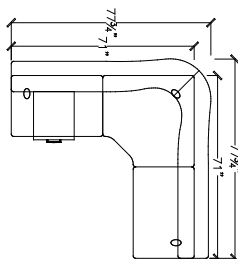
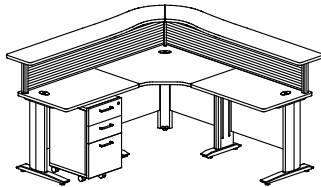

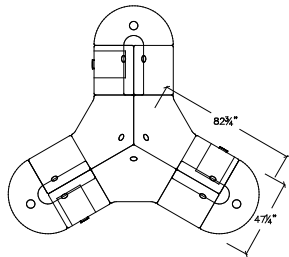
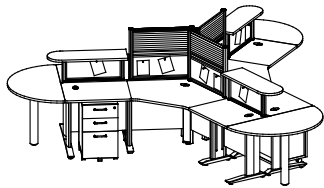

| ITEMS             | ITEM DESCRIPTION          | QTY | LIST            |
|-------------------|---------------------------|-----|-----------------|
| <b>LAYOUT #12</b> |                           |     |                 |
| 850-2430AC120     | 120° ANGLED CORNER MODULE | 3 x | \$919           |
| 850-2430LC        | LEFT CONNECTOR            | 3 x | \$465           |
| 850-2430RC        | RIGHT CONNECTOR           | 3 x | \$465           |
| 850-4824HM        | HALF MOON TOP             | 3 x | \$696           |
| OUT-12POST        | OUTLINES POST PACKAGE     | 6 x | \$94            |
| OUT-24POST        | POST PACKAGES             | 6 x | \$158           |
| OUT-1230TBP       | TACK-BOARD PANEL          | 6 x | \$289           |
| OUT-1230PYP       | POLYCARBONATE PANEL       | 3 x | \$240           |
| OUT1-1236BTA      | BULLET TRANSACTION TOP    | 3 x | \$276           |
| 850-MPUF          | MOBILE BBF PED            | 3 x | \$965           |
| <b>TOTAL</b>      |                           |     | <b>\$15,324</b> |

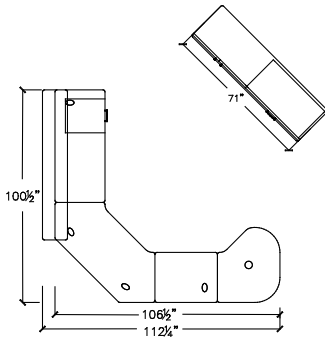
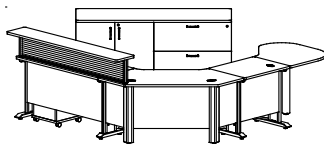

|                   |                          |     |                |
|-------------------|--------------------------|-----|----------------|
| <b>LAYOUT #13</b> |                          |     |                |
| 850-2430EMT-L     | END MEETING TABLE LEFT   |     | \$474          |
| 850-2430LC        | LEFT CONNECTOR           |     | \$465          |
| 850-2448NACM      | NEO-ANGLED CORNER MODULE |     | \$1,078        |
| 850-2454RC        | RIGHT CONNECTOR          |     | \$565          |
| 850-MPUF          | MOBILE BBF PED.          |     | \$965          |
| 850-2172TOP       | TOP ONLY                 |     | \$317          |
| 850-1936CX        | STORAGE CABINET - NO TOP |     | \$831          |
| 850-1936LFX       | NO TOP LATERAL FILE      |     | \$1,036        |
| OUT-12POST        | OUTLINES POST PACKAGE    | 2 x | \$94           |
| OUT-1272PYP       | POLYCARBONATE PANEL      |     | \$545          |
| OUT1-1272TA       | STRAIGHT TRANSACTION TOP |     | \$345          |
| <b>TOTAL</b>      |                          |     | <b>\$6,809</b> |

**LAYOUT #14 - LINEAR BENCHING LAYOUT FEATURING OUTLINES SERIES**

**HDL FRAMEWORK PANEL SYSTEM COMPONENTS**

|           |                      |     |       |
|-----------|----------------------|-----|-------|
| FRM-4848P | 48" TALL PANEL       | 3 x | \$560 |
| FRM-48PET | PANEL END TRIM       | 2 x | \$29  |
| FRM-PCK   | PANEL CONNECTING KIT | 2 x | \$40  |

PANEL COMPONENT TOTAL= **\$1,818**

**HEARTWOOD COMPONENTS**

|             |                          |      |       |
|-------------|--------------------------|------|-------|
| FRM-3048WS  | WORK SURFACE             | 6 x  | \$298 |
| FRM-GF30    | FULL GABLE               | 4 x  | \$285 |
| FRM-GH30    | HALF GABLE               | 4 x  | \$257 |
| FRM-1622MPF | MOBILE BOX/FILE PEDESTAL | 6 x  | \$794 |
| OUT-1230PYP | 12" POLYCARBONATE PANELS | 8 x  | \$240 |
| OUT-12POST  | OUTLINES POST PACKAGE    | 16 x | \$94  |

FURNITURE COMPONENT TOTAL= **\$12,144**

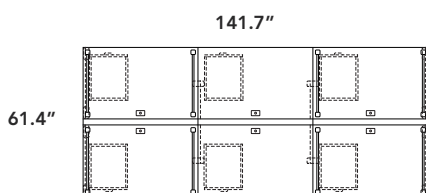
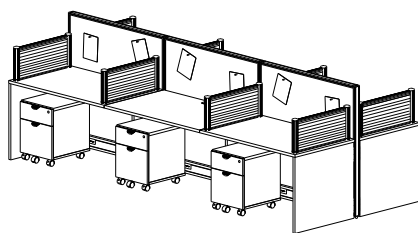

| ITEMS | ITEM DESCRIPTION | QTY | LIST |
|-------|------------------|-----|------|
|-------|------------------|-----|------|

**LAYOUT #15 - CUBICLE FEATURING 388 & OUTLINES SERIES**

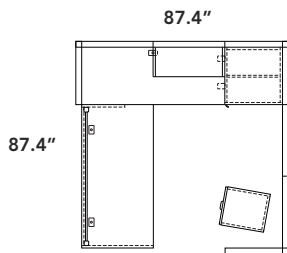
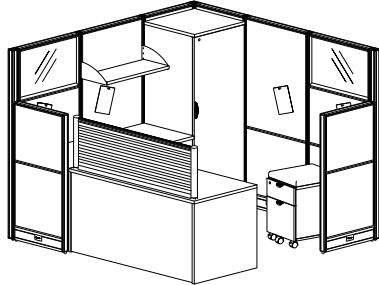

**HDL FRAMEWORK PANEL SYSTEM COMPONENTS**

|                        |                              |     |                |
|------------------------|------------------------------|-----|----------------|
| FRM-2448P              | 48" TALL PANEL               | 2 x | \$360          |
| FRM-3066GP             | 66" TALL CLEAR GLAZED PANEL  | 2 x | \$673          |
| FRM-3066P              | 66" TALL PANEL               | 2 x | \$509          |
| FRM-2466P              | 66" TALL PANEL               | 2 x | \$457          |
| FRM-66SQP-2W           | SQUARE 2 WAY CONNECTING POST | 3 x | \$109          |
| FRM-48PET              | PANEL END TRIM               | 2 x | \$29           |
| FRM-PCK                | PANEL CONNECTING KIT         | 4 x | \$40           |
| PANEL COMPONENT TOTAL= |                              |     | <b>\$4,543</b> |

**HEARTWOOD COMPONENTS**

|                            |                                   |     |                |
|----------------------------|-----------------------------------|-----|----------------|
| FRM-2460WS                 | WORK SURFACE                      |     | \$352          |
| FRM-OSS30                  | OVERHEAD SHELF                    |     | \$149          |
| FRM-1622MPF                | MOBILE BOX/FILE PEDESTAL          |     | \$794          |
| FRM-MPEDCUSH-HEA           | MOBILE PEDESTAL CUSHION- HEAVENLY |     | \$442          |
| FRM-WABK                   | WORK SURFACE ANGLE BRACKET KIT    |     | \$42           |
| 388-6524CLC-R-24           | SINGLE DOOR CLOSET CABINET        |     | \$1,862        |
| FRM-WFBK                   | WORK SURFACE FLUSH BRACKET KIT    |     | \$38           |
| 388-3060CT-B               | 30" CONNECTOR TOP - B GABLES      |     | \$803          |
| OUT-18POST                 | POST PACKAGES                     | 2 x | \$113          |
| OUT-1860PYP                | 18" POLYCARBONATE PANELS          |     | \$516          |
| FURNITURE COMPONENT TOTAL= |                                   |     | <b>\$5,224</b> |

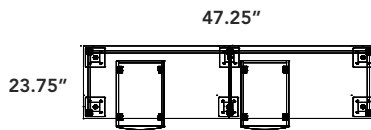
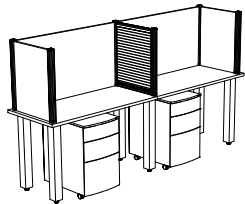

**LAYOUT #16 - CUSTOM 2 POD TEAMING STATION**

|              |                                       |     |                |
|--------------|---------------------------------------|-----|----------------|
| OUT-24POST   | POST PACKAGES                         | 6 x | \$158          |
| OUT-2450LAP  | 24" LAMINATE PANEL                    | 2 x | \$237          |
| OUT-2424PYP  | 24" POLYCARBONATE PANELS              |     | \$268          |
| OUT-2424LAP  | 24" LAMINATE PANELS                   | 2 x | \$141          |
| FLXS-REC2448 | 24" RECTANGLE TOP WITH SQUARE CORNERS | 2 x | \$246          |
| 900-SQ3      | 3" SQUARE LEG                         | 6 x | \$151          |
| 100-MMPUF    | METAL MOBILE PEDESTAL - FULL CARTON   | 2 x | \$540          |
| TOTAL=       |                                       |     | <b>\$4,450</b> |

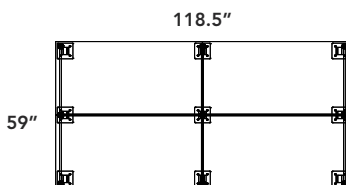
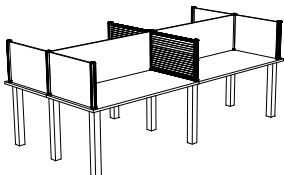

**LAYOUT #17 - CUSTOM 4 POD TEAMING STATION**

|              |                                     |     |                |
|--------------|-------------------------------------|-----|----------------|
| OUT-18POST   | POST PACKAGES                       | 9 x | \$113          |
| OUT-1832LAP  | *CUSTOM 18" LAMINATE PANEL          | 4 x | \$162          |
| OUT-1862LAP  | *CUSTOM 18" LAMINATE PANEL          | 2 x | \$237          |
| OUT-1832PYP  | *CUSTOM 18" POLYCARBONATE PANEL     | 2 x | \$317          |
| FLXS-REC3060 | 30" RECTANGLE TOP W/ SQUARE CORNERS | 4 x | \$384          |
| 900-SQ3      | 3" SQUARE LEG                       | 9 x | \$151          |
| TOTAL=       |                                     |     | <b>\$5,668</b> |

NOTES: GROMMETS CAN BE ADDED \$46 LIST EACH.  
\* NEXT SIZE UP PRICING.

ITEMS

ITEM DESCRIPTION

QTY

LIST

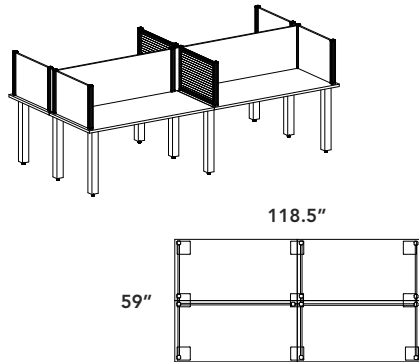

**LAYOUT #18 - STANDARD 4 POD TEAMING STATION**

|               |                                     |      |                |
|---------------|-------------------------------------|------|----------------|
| OUT-18POST    | POST PACKAGES                       | 13 x | \$113          |
| OUT-1830LAP-F | 18" LAMINATE PANELS W/ FILLER       | 2 x  | \$148          |
| OUT-1830LAP   | 18" LAMINATE PANELS                 | 2 x  | \$148          |
| OUT-1860LAP-F | 18" LAMINATE PANELS W/ FILLER       |      | \$218          |
| OUT-1860LAP   | 18" LAMINATE PANELS                 |      | \$218          |
| OUT-1830PYP-F | 18" POLYCARBONATE PANEL W/ FILLER   |      | \$277          |
| OUT-1830PYP   | 18" POLYCARBONATE PANEL             |      | \$277          |
| FLXS-REC3060  | 30" RECTANGLE TOP W/ SQUARE CORNERS | 4 x  | \$384          |
| 900-SQ3       | 3" SQUARE LEG                       | 9 x  | \$151          |
| <b>TOTAL=</b> |                                     |      | <b>\$5,946</b> |

**NOTE:** GROMMETS CAN BE ADDED \$46 LIST EACH.

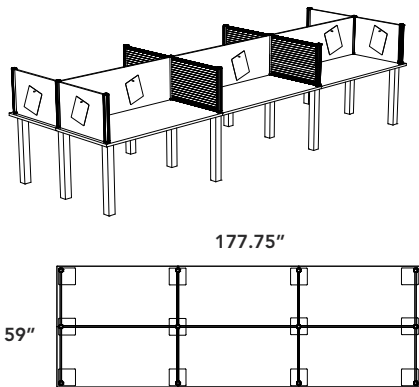

**LAYOUT #19 - CUSTOM 6 POD TEAMING STATION**

|               |                                     |      |                |
|---------------|-------------------------------------|------|----------------|
| OUT-12POST    | 12" OUTLINES POST PACKAGE           | 12 x | \$94           |
| OUT-1232TBP   | *CUSTOM 12" TACK BOARD PANEL        | 4 x  | \$298          |
| OUT-1232PYP   | *CUSTOM 12" POLYCARBONATE PANELS    | 4 x  | \$278          |
| OUT-1262TBP   | *CUSTOM 12" TACK BOARD PANEL        | 2 x  | \$431          |
| OUT-1264TBP   | *CUSTOM 12" TACK BOARD PANEL        |      | \$448          |
| FLXS-REC3060  | 30" RECTANGLE TOP W/ SQUARE CORNERS | 6 x  | \$384          |
| 900-SQ3       | 3" SQUARE LEG                       | 12 x | \$151          |
| <b>TOTAL=</b> |                                     |      | <b>\$8,858</b> |

**NOTES:** GROMMETS CAN BE ADDED \$46 LIST EACH.  
\* NEXT SIZE UP PRICING.

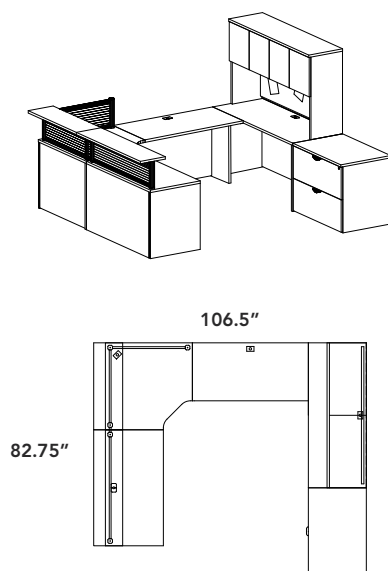

**LAYOUT #20 - RECEPTION U-SHAPE**

|               |                                   |     |                |
|---------------|-----------------------------------|-----|----------------|
| OUT-12POST    | 12" OUTLINES POST PACKAGE         | 5 x | \$94           |
| OUT-1236PYP   | 12" POLYCARBONATE PANEL           | 2 x | \$289          |
| OUT-1248PYP-F | 12" POLYCARBONATE PANEL W/ FILLER |     | \$386          |
| OUT1-1236TA   | STRAIGHT TRANSACTION TOP          |     | \$179          |
| OUT1-1248TA   | STRAIGHT TRANSACTION TOP          |     | \$234          |
| 388-2460CT-A  | 24" CONNECTOR TOP                 |     | \$716          |
| 388-2448RS    | NON-HANDED RETURN SHELL           |     | \$655          |
| 388-2436CM-C  | CORNER MODULE                     |     | \$829          |
| 388-2448CT-C  | 24" CONNECTOR TOP                 |     | \$672          |
| 388-3660HHD   | 36" HUTCH W/ DOORS & DIVIDER      |     | \$1,216        |
| 388-3660TB    | TACK BOARD FOR 36" HUTCHES        |     | \$325          |
| 388-2436LF    | 36" LATERAL FILE                  |     | \$1,167        |
| <b>TOTAL=</b> |                                   |     | <b>\$7,427</b> |

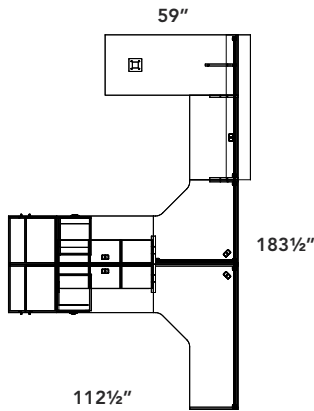
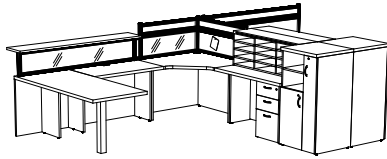

\*\*LAYOUT SHOWS NON-FLUTED EDGE. PLEASE INDICATED ON YOUR PO IF FLUTING IS **NOT** REQUIRED

| ITEMS                                    | ITEM DESCRIPTION                                     | QTY | LIST            |
|--|--|-----|-----------------|
| <b>LAYOUT #21 - 600 SERIES RECEPTION</b> |  |     |                 |
| 600-3060RBTG                             | RECTANGULAR BULLET TOP W/ FULL GABLE & 3" SQUARE LEG |     | <b>\$937</b>    |
| 600-2442CT-C                             | 24" CONNECTOR TOP                                    |     | <b>\$727</b>    |
| 600-2442CM-C                             | CORNER MODULE  |     | <b>\$1,109</b>  |
| 600-2448CT-B                             | 24" CONNECTOR TOP                                    | X2  | <b>\$766</b>    |
| 600-19FPUFX                              | FREESTANDING PEDESTAL - NO TOP                       | X2  | <b>\$871</b>    |
| 600-4724OCWR-24                          | WARDROBE STORAGE CABINETS                            |     | <b>\$1,538</b>  |
| 600-4724OCWL-24                          | WARDROBE STORAGE CABINETS                            |     | <b>\$1,538</b>  |
| 600-4272CM                               | CORNER MODULE EXTENDED RIGHT                         |     | <b>\$1,620</b>  |
| OUT2-1272TA                              | STRAIGHT TRANSACTION TOPS                            |     | <b>\$443</b>    |
| 600-1848DTO                              | DESKTOP ORGANIZER                                    | X2  | <b>\$737</b>    |
| OUT-1272PLX-F                            | 12" PLEXIGLASS PANEL W/ FILLER                       | X2  | <b>\$555</b>    |
| OUT-1242PLX                              | 12" PLEXIGLASS PANEL                                 |     | <b>\$325</b>    |
| OUT-1242TBP                              | 12" TACK-BOARD PANEL                                 |     | <b>\$338</b>    |
| OUT-0642PLX                              | 6" TOP PANEL   | X2  | <b>\$325</b>    |
| OUT-0672PLX-F                            | 6" TOP PANEL W/ FILLER                               |     | <b>\$555</b>    |
| OUT-12POST                               | OUTLINES POST PACKAGE                                | X2  | <b>\$94</b>     |
| OUT-18POST                               | POST PACKAGE   | X5  | <b>\$113</b>    |
| <b>TOTAL=</b>                            |  |     | <b>\$16,391</b> |

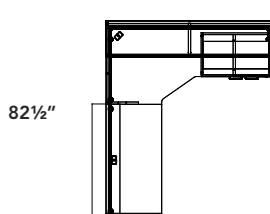
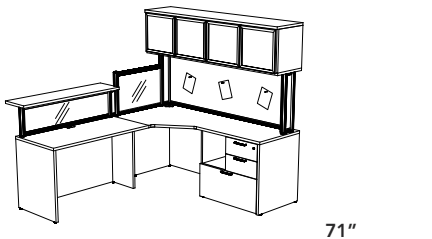

|                   |  |    |                |
|-------------------|--|----|----------------|
| <b>LAYOUT #22</b> |  |    |                |
| OUT-12POST        | OUTLINES POST PACKAGE                            | X2 | <b>\$94</b>    |
| OUT-18POST        | 18" OUTLINES POST PACKAGE                        |    | <b>\$113</b>   |
| OUT-1248PLX-F     | 12" PLEXIGLASS PANELS W/ FILLER                  |    | <b>\$400</b>   |
| OUT-1830PLX       | 18" PLEXIGLASS PANELS                            |    | <b>\$292</b>   |
| OUT-24LAP-HFP     | LAMINATE HUTCH FILLER PANELS                     | X2 | <b>\$86</b>    |
| OUT1-1248TA       | STRAIGHT TRANSACTION TOP                         |    | <b>\$234</b>   |
| 388-3672CM        | CORNER MODULE EXTENDED RIGHT                     |    | <b>\$1,168</b> |
| 388-2448CT-B      | 24" CONNECTOR TOP                                |    | <b>\$672</b>   |
| OUT1-4172HHD-AGD  | HUTCH WITH ALUMINIUM GLASS HINGED DOORS          |    | <b>\$1,456</b> |
|                   | AGD UP-CHARGE                                    |    | <b>\$893</b>   |
| OUT-2472TBP       | 24" TACK-BOARD PANEL                             |    | <b>\$586</b>   |
| 388-1930OBBLFX    | OPEN LATERAL FILE/BOX/BOX COMBO STORAGE - NO TOP |    | <b>\$1,178</b> |
| <b>TOTAL=</b>     |  |    | <b>\$7,352</b> |

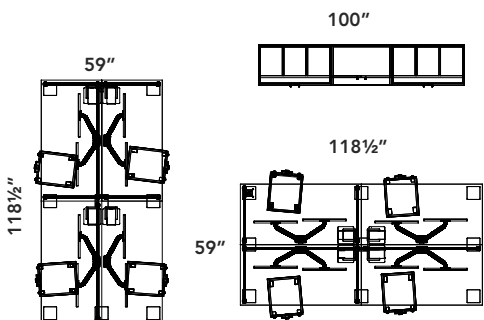
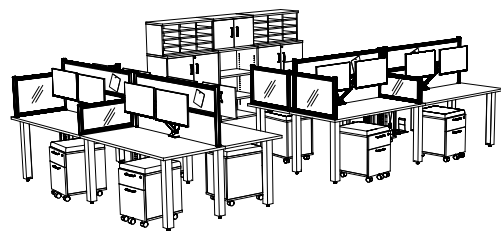

| ITEMS             | ITEM DESCRIPTION                  | QTY | LIST    |
|-------------------|-----------------------------------|-----|---------|
| <b>LAYOUT #23</b> |                                   |     |         |
| OUT-12POST        | 12" OUTLINES POST PACKAGE         | X6  | \$94    |
| OUT-18POST        | 18" OUTLINES POST PACKAGE         | X6  | \$113   |
| OUT-24POST        | 24" OUTLINES POST PACKAGE         | X8  | \$158   |
| OUT-1260TBP       | 12" TACK BOARD PANELS             | X4  | \$414   |
| OUT-1260LAP       | 12" LAMINATE PANELS               | X4  | \$191   |
| OUT-1830PLX       | 18" PLEXIGLASS PANELS             | X2  | \$292   |
| OUT-1830PLX-F     | 18" PLEXIGLASS PANELS WITH FILLER | X2  | \$292   |
| OUT-1230PLX       | 12" PLEXIGLASS PANELS             | X2  | \$252   |
| OUT-1230PLX-F     | 12" PLEXIGLASS PANELS WITH FILLER | X2  | \$252   |
| OUT-24FILLER-LAP  | OUTLINES FILLER PANEL             | X2  | \$71    |
| FLXS-REC3060      | 30" RECTANGLE TOPS                | X8  | \$384   |
| 900-SQ3           | 3" SQUARE LEG                     | X18 | \$151   |
| 388-4736C-20      | MID-HEIGHT CABINET                | X2  | \$1,358 |
| 388-4736CO-20     | OPEN MID-HEIGHT CABINET           |     | \$1,233 |
| 388-1830DTC       | DESKTOP CABINET                   |     | \$606   |
| 388-1836MS        | DESKTOP MAIL SORT - 16" DEEP UNIT | X2  | \$598   |
| 388-1622MPF       | MOBILE PEDESTAL                   | X8  | \$834   |
| WRK-MPEDCUSH-ESC  | PEDESTAL CUSHION                  | X8  | \$393   |
| 100-MA2           | PNEUMATIC LCD DUAL MONITOR ARM    | X8  | \$436   |
| 100-2-HCPU        | HANGING CPU HOLDER                | X8  | \$188   |

TOTAL= **\$33,593**

Factory installed 2" x 3" Grommet (\$46 each list) available for FLEX series tops. Location of grommet/s must be specified with order.

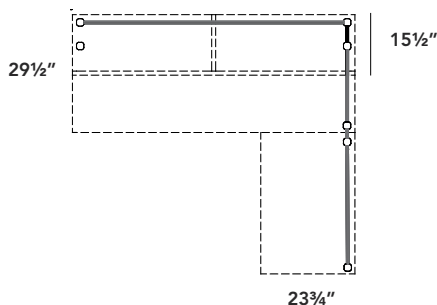
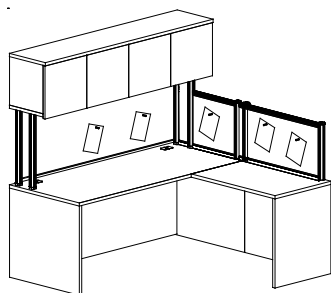

|                   |   |     |         |
|-------------------|---|-----|---------|
| <b>LAYOUT #24</b> |   |     |         |
| OUT1-4172HHD      | 41" HUTCH W/ HINGED LAMINATE DOORS      | 1 x | \$1,456 |
| OUT-2472TBP       | STANDARD TACK-BOARD PANEL               | 1 x | \$586   |
| OUT-24TBP-HFP     | HUTCH FILLER PANEL - TACK-BOARD (SEE A) | 1 x | \$249   |
| OUT-1824TBP       | 18" TACK BOARD PANELS                   | 1 x | \$285   |
| OUT-1848TBP-F     | STANDARD TACK-BOARD PANEL W/ FILLER     | 1 x | \$377   |
| OUT-18POST        | POST PACKAGES                           | 3 x | \$113   |
| 388-3072CT-A      | 30" CONNECTOR TOP W/ A GABLE SET        | 1 x | \$879   |
| 388-2448RS        | 24" NON-HANDED RETURN SHELL             | 1 x | \$655   |

TOTAL= **\$4,826**

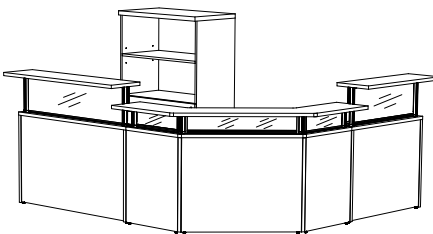
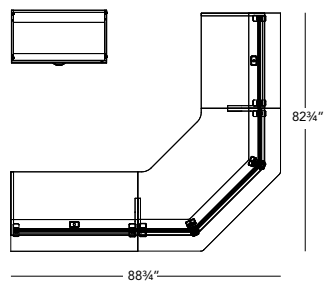

|  | ITEMS  | ITEM DESCRIPTION               | QTY   | LIST           |
|--|--|--------------------------------|-------|----------------|
| <br> | <b>LAYOUT #25 (SHOWN IN 388 SERIES BROCHURE)</b> |                                |       |                |
|  | <b>OUT-648PLX-NAPS-F</b>                         | NEO-ANGLE CORNER PANEL SETS    |       | <b>\$834</b>   |
|  | <b>OUT1-1248NATA</b>                             | NEO-ANGLE TRANSACTION TOPS     |       | <b>\$534</b>   |
|  | <b>388-2448NACM</b>                              | NEO-ANGLE CORNER MODULE        |       | <b>\$1,325</b> |
|  | <b>OUT-1236PLX</b>                               | 12" PLEXIGLASS PANEL           |       | <b>\$299</b>   |
|  | <b>OUT-1248PLX</b>                               | 12" PLEXIGLASS PANEL           |       | <b>\$400</b>   |
|  | <b>OUT1-1236TA</b>                               | STRAIGHT TRANSACTION TOP       |       | <b>\$179</b>   |
|  | <b>OUT1-1248TA</b>                               | STRAIGHT TRANSACTION TOP       |       | <b>\$234</b>   |
|  | <b>OUT-12POST</b>                                | OUTLINES POST PACKAGE          | X4    | <b>\$94</b>    |
|  | <b>OUT-6POST</b>                                 | 6" OUTLINES POST PACKAGE       | X4    | <b>\$94</b>    |
|  | <b>388-2448CT-B</b>                              | 24" CONNECTOR TOP              |       | <b>\$672</b>   |
|  | <b>388-2436CT-B</b>                              | 24" CONNECTOR TOP              |       | <b>\$615</b>   |
|  | <b>388-2436O2LF4</b>                             | OPEN TALL LATERAL FILE STORAGE |       | <b>\$2,185</b> |
|  |  |                                | TOTAL | <b>\$8,029</b> |

## Features and Specifications:

- ♥ Quick and easy to install
- ♥ Low-cost privacy panel alternative
- ♥ Edge mount panels can be used as a temporary solution  
(Brackets are installed on underside of work surface and are removable)
- ♥ Aesthetically pleasing, contemporary design

### Brackets

- ♥ Top Mount (TM1), Edge Mount (EM1) or Free Standing (FS1) brackets available
- ♥ Available in two finishes – Black (BL) and Silver (SL). FS1 brackets are only available in Silver (SL)
- ♥ Mounts easily on the work surface and can be installed on new or existing furniture.
- ♥ All mounting hardware included and positioning templates are not needed.
- ♥ Edge Mount brackets require 1.25" clearance on the underside of worksurface mounting edge for proper installation.
- ♥ Anti-slip Free Standing (FS1) brackets rest on the work surface and can be removed. (no drilling)

TM1

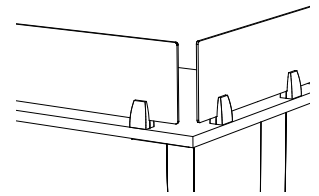

EM1

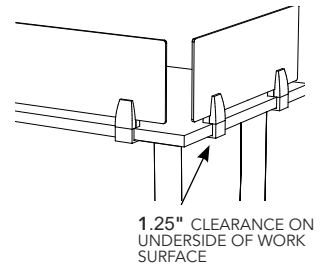

FS1

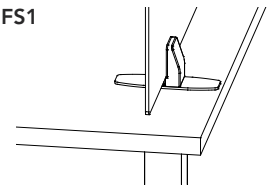

## Panel Configuration Overview

### Panels

- ♥ Available in laminate, plexiglass, tack board, or acoustic PET finish
  - Plexiglass (PLX), in 3 styles - Clear (CL), Frosted (FR), or Bronze (BR) with stylish radius corner detailing on the top edge of the panel
  - Laminate (LAP), available in all standard Heartwood finishes with durable matching 2mm edge band on all sides
  - Tack Board (TBP), available in all standard Heartwood Escape fabric finishes
  - Acoustic PET (PET), available Charcoal Grey (CH), Storm Grey (ST), or Tan (TN) with stylish radius corner detailing on the top edge of the panel
- ♥ Panels are available in three heights: 8", 15" or 22"
- ♥ Panels are not compatible with Outlines accessories
- ♥ Heights, bracket styles and finishes can be combined when planning configurations
- ♥ The default installation is inset 2" from the edge of worksurface as shown below

### Top Mount

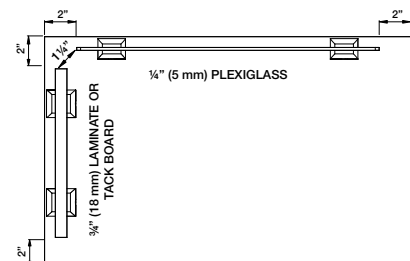
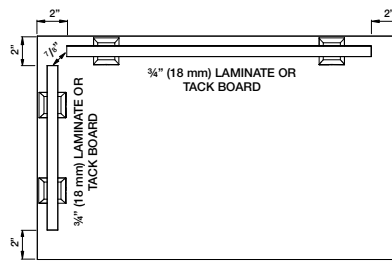
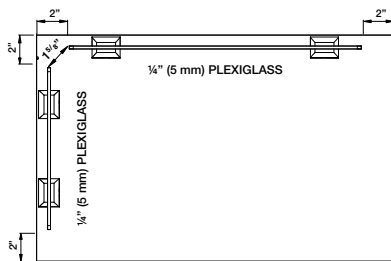

### Top Mount Brackets & HDL Framework Panels

- ♥ Outlines Plus top mount panels can be used with Heartwood Distributors' (HDL) Framework Modular Panel System
- ♥ Top mount bracket mounts through top panel trim of panel into solid core structure
- ♥ Wood/metal screws included (not self tapping metal screws)
- ♥ 1/8" pilot hole is suggested prior to install of panel, drill bit not included. Full details of assembly instructions include mounting details
- ♥ Compatible with 3rd party panels as long as the panels aren't hollow and has something to attach to, we include 1.75" long screws in the package (we cannot warranty product if not compatible with 3rd party panels).

**Edge Mount**

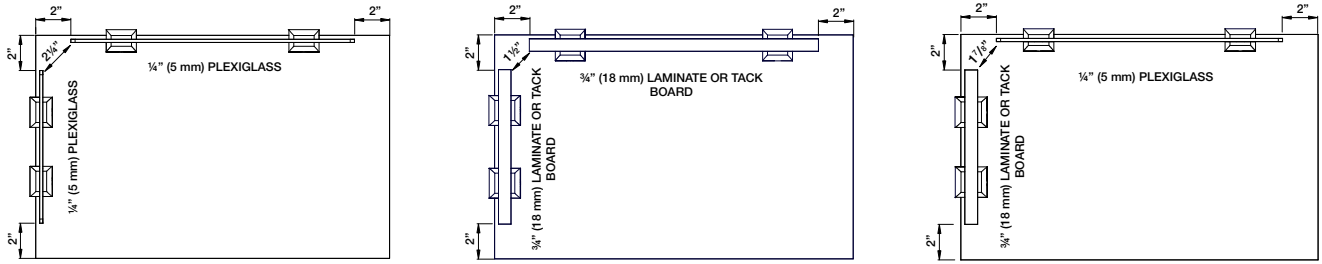

**Notes:**

- ♥ Edge mount (EM1) brackets must be mounted on **1" ONLY** worksurfaces with an edge.
- ♥ For installations where gables or modesty panels are flush to the worksurface top, use top mount (TM1) brackets
- ♥ Top mount brackets and edge mount brackets can not be used in combination on the same panel.
- ♥ When edge mount (EM1) brackets are installed between worksurfaces, there will be a gap. For flush installations, use top mount (TM1) bracket panels.

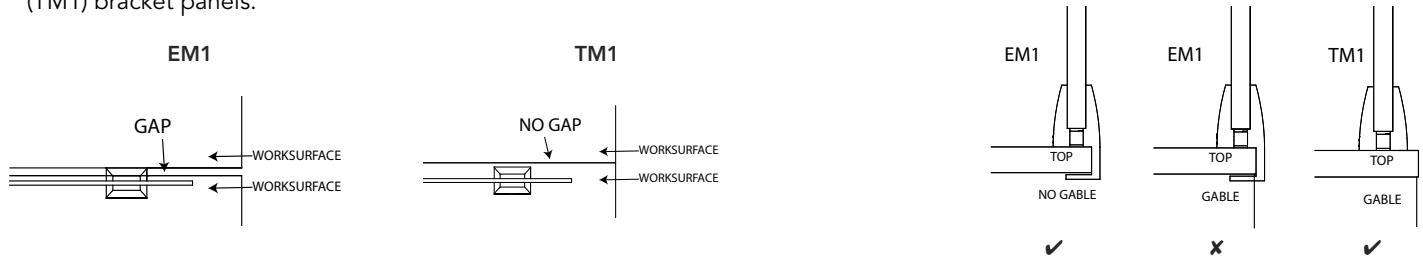

**Custom Sizes**

- ♥ Custom available.....call Customer Service. Please specify quote number when ordering. For simple width; changes, use the price of the next size up.

**Ordering Example:** To price a custom size Outlines Plus panel TM1-1546PLX-BR-SL **use the pricing for** TM1-1548PLX-BR-SL

**Shipping**

- ♥ All Outlines plus panels with mounting brackets are shipped **RTA**

**Warranty**

- ♥ Limited lifetime

**NOTE:** Information is current at the time of print. For up to date information check online at [WWW.HEARTWOOD.CA](http://WWW.HEARTWOOD.CA).

| MODEL | LIST | WEIGHT | CUBE            | W  | D  | H  |
|-------|------|--------|-----------------|----|----|----|
|       |      | LBS    | FT <sup>3</sup> | IN | IN | IN |

**8" TOP MOUNT LAMINATE PRIVACY PANEL**

ALL MOUNTING HARDWARE INCLUDED.

2 TOP MOUNTING BRACKETS

|             |       |       |       |       |      |   |
|-------------|-------|-------|-------|-------|------|---|
| TM1-0824LAP | \$171 | 6.56  | 0.08  | 19.75 | 0.75 | 8 |
| TM1-0830LAP | \$177 | 8.41  | 0.104 | 25.75 | 0.75 | 8 |
| TM1-0836LAP | \$183 | 10.27 | 0.127 | 31.5  | 0.75 | 8 |
| TM1-0842LAP | \$191 | 12.12 | 0.151 | 37.5  | 0.75 | 8 |
| TM1-0848LAP | \$197 | 13.98 | 0.175 | 43.5  | 0.75 | 8 |

3 TOP MOUNTING BRACKETS

|             |       |       |       |       |      |   |
|-------------|-------|-------|-------|-------|------|---|
| TM1-0854LAP | \$214 | 15.83 | 0.199 | 49.25 | 0.75 | 8 |
| TM1-0860LAP | \$227 | 17.67 | 0.222 | 55.25 | 0.75 | 8 |
| TM1-0866LAP | \$240 | 19.54 | 0.246 | 61.25 | 0.75 | 8 |
| TM1-0872LAP | \$265 | 21.38 | 0.27  | 67    | 0.75 | 8 |
| TM1-0878LAP | \$288 | 23.25 | 0.294 | 73    | 0.75 | 8 |

4 TOP MOUNTING BRACKETS

|             |       |       |       |       |      |   |
|-------------|-------|-------|-------|-------|------|---|
| TM1-0884LAP | \$312 | 25.09 | 0.317 | 78.75 | 0.75 | 8 |
| TM1-0890LAP | \$331 | 26.94 | 0.341 | 84.75 | 0.75 | 8 |
| TM1-0896LAP | \$342 | 28.8  | 0.365 | 90.75 | 0.75 | 8 |

AVAILABLE BRACKET FINISH: BLACK (BL) OR SILVER (SL)

AVAILABLE PANEL FINISH: ALL AVAILABLE HEARTWOOD LAMINATE FINISHES

**15" TOP MOUNT LAMINATE PRIVACY PANEL**

ALL MOUNTING HARDWARE INCLUDED.

2 TOP MOUNTING BRACKETS

|             |       |       |       |       |      |    |
|-------------|-------|-------|-------|-------|------|----|
| TM1-1524LAP | \$188 | 11.97 | 0.148 | 19.75 | 0.75 | 15 |
| TM1-1530LAP | \$195 | 15.44 | 0.192 | 25.75 | 0.75 | 15 |
| TM1-1536LAP | \$201 | 18.92 | 0.237 | 31.5  | 0.75 | 15 |
| TM1-1542LAP | \$210 | 22.39 | 0.281 | 37.5  | 0.75 | 15 |
| TM1-1548LAP | \$218 | 25.87 | 0.325 | 43.5  | 0.75 | 15 |

3 TOP MOUNTING BRACKETS

|             |       |       |       |       |      |    |
|-------------|-------|-------|-------|-------|------|----|
| TM1-1554LAP | \$235 | 29.34 | 0.369 | 49.25 | 0.75 | 15 |
| TM1-1560LAP | \$250 | 32.82 | 0.413 | 55.25 | 0.75 | 15 |
| TM1-1566LAP | \$262 | 36.29 | 0.457 | 61.25 | 0.75 | 15 |
| TM1-1572LAP | \$292 | 39.77 | 0.502 | 67    | 0.75 | 15 |
| TM1-1578LAP | \$317 | 43.23 | 0.546 | 73    | 0.75 | 15 |

4 TOP MOUNTING BRACKETS

|             |       |       |       |       |      |    |
|-------------|-------|-------|-------|-------|------|----|
| TM1-1584LAP | \$342 | 46.72 | 0.59  | 78.75 | 0.75 | 15 |
| TM1-1590LAP | \$363 | 50.18 | 0.634 | 84.75 | 0.75 | 15 |
| TM1-1596LAP | \$377 | 53.67 | 0.678 | 90.75 | 0.75 | 15 |

AVAILABLE BRACKET FINISH: BLACK (BL) OR SILVER (SL)

AVAILABLE PANEL FINISH: ALL AVAILABLE HEARTWOOD LAMINATE FINISHES

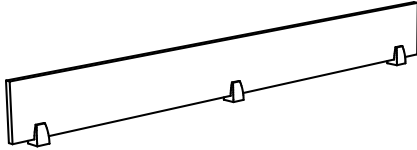

TM1-0872LAP

RTA

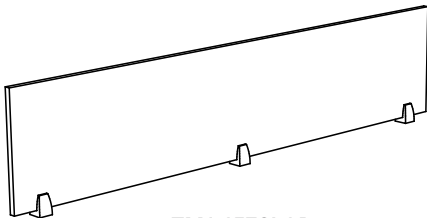

TM1-1572LAP

RTA

| MODEL | LIST | WEIGHT | CUBE            | W  | D  | H  |
|-------|------|--------|-----------------|----|----|----|
|       |      | LBS    | FT <sup>3</sup> | IN | IN | IN |

**22" TOP MOUNT LAMINATE PRIVACY PANEL**

ALL MOUNTING HARDWARE INCLUDED.

2 TOP MOUNTING BRACKETS

|             |       |       |       |       |      |       |
|-------------|-------|-------|-------|-------|------|-------|
| TM1-2224LAP | \$206 | 17.36 | 0.217 | 19.75 | 0.75 | 21.75 |
| TM1-2230LAP | \$215 | 22.47 | 0.281 | 25.75 | 0.75 | 21.75 |
| TM1-2236LAP | \$222 | 27.57 | 0.346 | 31.5  | 0.75 | 21.75 |
| TM1-2242LAP | \$230 | 32.66 | 0.41  | 37.5  | 0.75 | 21.75 |
| TM1-2248LAP | \$240 | 37.76 | 0.475 | 43.5  | 0.75 | 21.75 |

3 TOP MOUNTING BRACKETS

|             |       |       |       |       |      |       |
|-------------|-------|-------|-------|-------|------|-------|
| TM1-2254LAP | \$259 | 42.87 | 0.54  | 49.25 | 0.75 | 21.75 |
| TM1-2260LAP | \$276 | 47.95 | 0.604 | 55.25 | 0.75 | 21.75 |
| TM1-2266LAP | \$288 | 53.05 | 0.669 | 61.25 | 0.75 | 21.75 |
| TM1-2272LAP | \$322 | 58.14 | 0.733 | 67    | 0.75 | 21.75 |
| TM1-2278LAP | \$351 | 63.24 | 0.798 | 73    | 0.75 | 21.75 |

4 TOP MOUNTING BRACKETS

|             |       |       |       |       |      |       |
|-------------|-------|-------|-------|-------|------|-------|
| TM1-2284LAP | \$390 | 68.35 | 0.862 | 78.75 | 0.75 | 21.75 |
| TM1-2290LAP | \$426 | 73.43 | 0.927 | 84.75 | 0.75 | 21.75 |
| TM1-2296LAP | \$449 | 78.54 | 0.991 | 90.75 | 0.75 | 21.75 |

AVAILABLE BRACKET FINISH: BLACK (BL) OR SILVER (SL)

AVAILABLE PANEL FINISH: ALL AVAILABLE HEARTWOOD LAMINATE FINISHES

**8" TOP MOUNT PLEXIGLASS PRIVACY PANEL**

ALL MOUNTING HARDWARE INCLUDED.

2 TOP MOUNTING BRACKETS

|             |       |       |       |       |      |   |
|-------------|-------|-------|-------|-------|------|---|
| TM1-0824PLX | \$205 | 6.56  | 0.033 | 19.75 | 0.25 | 8 |
| TM1-0830PLX | \$224 | 8.41  | 0.042 | 25.75 | 0.25 | 8 |
| TM1-0836PLX | \$235 | 10.27 | 0.052 | 31.5  | 0.25 | 8 |
| TM1-0842PLX | \$241 | 12.12 | 0.062 | 37.5  | 0.25 | 8 |
| TM1-0848PLX | \$253 | 13.98 | 0.072 | 43.5  | 0.25 | 8 |

3 TOP MOUNTING BRACKETS

|             |       |       |       |       |      |   |
|-------------|-------|-------|-------|-------|------|---|
| TM1-0854PLX | \$306 | 15.83 | 0.081 | 49.25 | 0.25 | 8 |
| TM1-0860PLX | \$332 | 17.67 | 0.091 | 55.25 | 0.25 | 8 |
| TM1-0866PLX | \$350 | 19.54 | 0.101 | 61.25 | 0.25 | 8 |
| TM1-0872PLX | \$378 | 21.38 | 0.11  | 67    | 0.25 | 8 |
| TM1-0878PLX | \$405 | 23.25 | 0.12  | 73    | 0.25 | 8 |

4 TOP MOUNTING BRACKETS

|             |       |       |       |       |      |   |
|-------------|-------|-------|-------|-------|------|---|
| TM1-0884PLX | \$432 | 25.09 | 0.13  | 78.75 | 0.25 | 8 |
| TM1-0890PLX | \$480 | 26.94 | 0.14  | 84.75 | 0.25 | 8 |
| TM1-0896PLX | \$506 | 28.8  | 0.149 | 90.75 | 0.25 | 8 |

AVAILABLE BRACKET FINISH: BLACK (BL) OR SILVER (SL)

PLEXIGLASS FINISH: BRONZE (BR), CLEAR (CL) & FROSTED (FR)

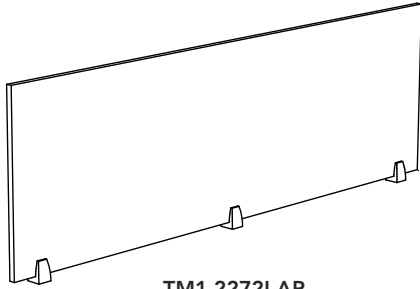

TM1-2272LAP

RTA

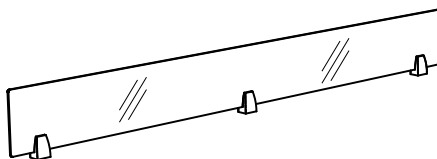

TM1-0872PLX

RTA

| MODEL | LIST | WEIGHT | CUBE            | W  | D  | H  |
|-------|------|--------|-----------------|----|----|----|
|       |      | LBS    | FT <sup>3</sup> | IN | IN | IN |

**15" TOP MOUNT PLEXIGLASS PRIVACY PANEL**

ALL MOUNTING HARDWARE INCLUDED.

2 TOP MOUNTING BRACKETS

|             |       |       |       |       |      |    |
|-------------|-------|-------|-------|-------|------|----|
| TM1-1524PLX | \$412 | 11.97 | 0.061 | 19.75 | 0.25 | 15 |
| TM1-1530PLX | \$430 | 15.44 | 0.079 | 25.75 | 0.25 | 15 |
| TM1-1536PLX | \$441 | 18.92 | 0.097 | 31.5  | 0.25 | 15 |
| TM1-1542PLX | \$461 | 22.39 | 0.115 | 37.5  | 0.25 | 15 |
| TM1-1548PLX | \$477 | 25.87 | 0.133 | 43.5  | 0.25 | 15 |

3 TOP MOUNTING BRACKETS

|             |       |       |       |       |      |    |
|-------------|-------|-------|-------|-------|------|----|
| TM1-1554PLX | \$497 | 29.34 | 0.151 | 49.25 | 0.25 | 15 |
| TM1-1560PLX | \$525 | 32.82 | 0.169 | 55.25 | 0.25 | 15 |
| TM1-1566PLX | \$546 | 36.29 | 0.187 | 61.25 | 0.25 | 15 |
| TM1-1572PLX | \$605 | 39.77 | 0.205 | 67    | 0.25 | 15 |
| TM1-1578PLX | \$667 | 43.23 | 0.223 | 73    | 0.25 | 15 |

4 TOP MOUNTING BRACKETS

|             |       |       |       |       |      |    |
|-------------|-------|-------|-------|-------|------|----|
| TM1-1584PLX | \$701 | 46.72 | 0.241 | 78.75 | 0.25 | 15 |
| TM1-1590PLX | \$725 | 50.18 | 0.259 | 84.75 | 0.25 | 15 |
| TM1-1596PLX | \$740 | 53.67 | 0.277 | 90.75 | 0.25 | 15 |

AVAILABLE BRACKET FINISH: BLACK (BL) OR SILVER (SL)

PLEXIGLASS FINISH: BRONZE (BR), CLEAR (CL) & FROSTED (FR)

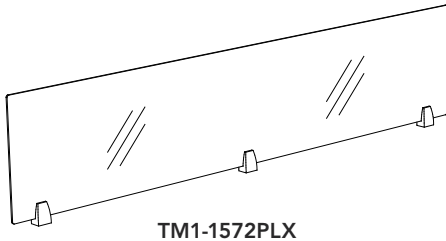

TM1-1572PLX

RTA

**8" TOP MOUNT TACK BOARD PRIVACY PANEL**

ALL MOUNTING HARDWARE INCLUDED.

2 TOP MOUNTING BRACKETS

|             |       |      |      |       |   |   |
|-------------|-------|------|------|-------|---|---|
| TM1-0824TBP | \$413 | 2.56 | 0.16 | 19.75 | 1 | 8 |
| TM1-0830TBP | \$418 | 2.98 | 0.2  | 25.75 | 1 | 8 |
| TM1-0836TBP | \$432 | 3.42 | 0.24 | 31.5  | 1 | 8 |
| TM1-0842TBP | \$465 | 3.84 | 0.28 | 37.5  | 1 | 8 |
| TM1-0848TBP | \$499 | 4.28 | 0.32 | 43.5  | 1 | 8 |

3 TOP MOUNTING BRACKETS

|             |       |      |      |       |   |   |
|-------------|-------|------|------|-------|---|---|
| TM1-0854TBP | \$517 | 4.70 | 0.36 | 49.25 | 1 | 8 |
| TM1-0860TBP | \$659 | 5.14 | 0.4  | 55.25 | 1 | 8 |
| TM1-0866TBP | \$677 | 5.56 | 0.44 | 61.25 | 1 | 8 |
| TM1-0872TBP | \$687 | 5.95 | 0.48 | 67    | 1 | 8 |
| TM1-0878TBP | \$705 | 6.39 | 0.52 | 73    | 1 | 8 |

4 TOP MOUNTING BRACKETS

|             |       |      |      |       |   |   |
|-------------|-------|------|------|-------|---|---|
| TM1-0884TBP | \$748 | 6.83 | 0.56 | 78.75 | 1 | 8 |
| TM1-0890TBP | \$816 | 7.28 | 0.61 | 84.75 | 1 | 8 |
| TM1-0896TBP | \$855 | 7.72 | 0.65 | 90.75 | 1 | 8 |

AVAILABLE BRACKET FINISH: BLACK (BL) OR SILVER (SL)

AVAILABLE TACK BOARD FINISH: ALL ESCAPE TACK BOARD FABRICS.

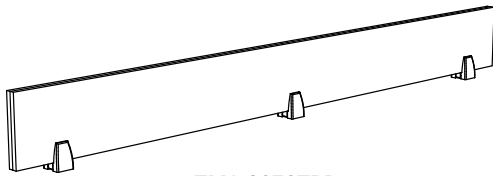

TM1-0872TBP

RTA

| MODEL | LIST | WEIGHT | CUBE            | W  | D  | H  |
|-------|------|--------|-----------------|----|----|----|
|       |      | LBS    | FT <sup>3</sup> | IN | IN | IN |

**15" TOP MOUNT TACK BOARD PRIVACY PANEL**

ALL MOUNTING HARDWARE INCLUDED.

2 TOP MOUNT BRACKETS

|             |       |      |      |       |   |    |
|-------------|-------|------|------|-------|---|----|
| TM1-1524TBP | \$436 | 3.79 | 0.26 | 19.75 | 1 | 15 |
| TM1-1530TBP | \$440 | 4.61 | 0.32 | 25.75 | 1 | 15 |
| TM1-1536TBP | \$455 | 5.42 | 0.39 | 31.5  | 1 | 15 |
| TM1-1542TBP | \$491 | 6.28 | 0.46 | 37.5  | 1 | 15 |
| TM1-1548TBP | \$525 | 7.03 | 0.52 | 43.5  | 1 | 15 |

3 TOP MOUNT BRACKETS

|             |       |       |      |       |   |    |
|-------------|-------|-------|------|-------|---|----|
| TM1-1554TBP | \$544 | 7.83  | 0.59 | 49.25 | 1 | 15 |
| TM1-1560TBP | \$694 | 8.64  | 0.66 | 55.25 | 1 | 15 |
| TM1-1566TBP | \$713 | 9.44  | 0.72 | 61.25 | 1 | 15 |
| TM1-1572TBP | \$731 | 10.25 | 0.79 | 67    | 1 | 15 |
| TM1-1578TBP | \$762 | 11.05 | 0.86 | 73    | 1 | 15 |

4 TOP MOUNT BRACKETS

|             |       |       |      |       |   |    |
|-------------|-------|-------|------|-------|---|----|
| TM1-1584TBP | \$832 | 11.86 | 0.92 | 78.75 | 1 | 15 |
| TM1-1590TBP | \$906 | 12.65 | 0.99 | 84.75 | 1 | 15 |
| TM1-1596TBP | \$951 | 13.47 | 1.06 | 90.75 | 1 | 15 |

AVAILABLE BRACKET FINISH: BLACK (BL) OR SILVER (SL)

AVAILABLE TACK BOARD FINISH: ALL ESCAPE TACK BOARD FABRICS.

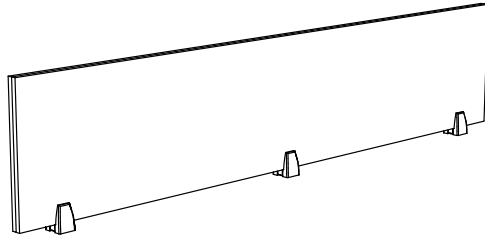

TM1-1572TBP

RTA

**22" TOP MOUNT TACK BOARD PRIVACY PANEL**

ALL MOUNTING HARDWARE INCLUDED.

2 TOP MOUNT BRACKETS

|             |       |      |      |       |   |       |
|-------------|-------|------|------|-------|---|-------|
| TM1-2224TBP | \$544 | 5.05 | 0.36 | 19.75 | 1 | 21.75 |
| TM1-2230TBP | \$551 | 6.24 | 0.45 | 25.75 | 1 | 21.75 |
| TM1-2236TBP | \$569 | 7.41 | 0.54 | 31.5  | 1 | 21.75 |
| TM1-2242TBP | \$613 | 8.60 | 0.63 | 37.5  | 1 | 21.75 |
| TM1-2248TBP | \$657 | 9.79 | 0.73 | 43.5  | 1 | 21.75 |

3 TOP MOUNT BRACKETS

|             |       |       |      |       |   |       |
|-------------|-------|-------|------|-------|---|-------|
| TM1-2254TBP | \$679 | 10.96 | 0.82 | 49.25 | 1 | 21.75 |
| TM1-2260TBP | \$833 | 12.15 | 0.91 | 55.25 | 1 | 21.75 |
| TM1-2266TBP | \$855 | 13.32 | 1    | 61.25 | 1 | 21.75 |
| TM1-2272TBP | \$871 | 14.51 | 1.1  | 67    | 1 | 21.75 |
| TM1-2278TBP | \$900 | 15.67 | 1.19 | 73    | 1 | 21.75 |

4 TOP MOUNT BRACKETS

|             |         |       |      |       |   |       |
|-------------|---------|-------|------|-------|---|-------|
| TM1-2284TBP | \$956   | 16.87 | 1.28 | 78.75 | 1 | 21.75 |
| TM1-2290TBP | \$1,042 | 18.06 | 1.38 | 84.75 | 1 | 21.75 |
| TM1-2296TBP | \$1,093 | 19.22 | 1.47 | 90.75 | 1 | 21.75 |

AVAILABLE BRACKET FINISH: BLACK (BL) OR SILVER (SL)

AVAILABLE TACK BOARD FINISH: ALL ESCAPE TACK BOARD FABRICS.

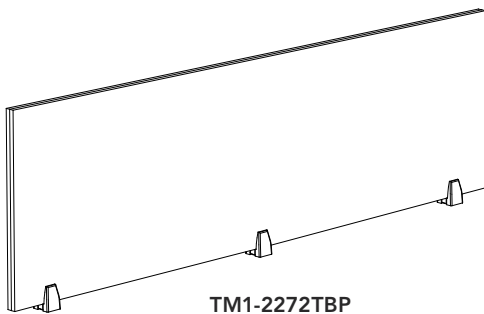

TM1-2272TBP

RTA

| MODEL | LIST | WEIGHT | CUBE            | W  | D  | H  |
|-------|------|--------|-----------------|----|----|----|
|       |      | LBS    | FT <sup>3</sup> | IN | IN | IN |

### 8" TOP MOUNT ACOUSTIC PET PRIVACY PANEL

ALL MOUNTING HARDWARE INCLUDED

2 TOP MOUNT BRACKETS

|             |       |      |      |       |     |   |
|-------------|-------|------|------|-------|-----|---|
| TM1-0824PET | \$262 | 2.3  | 0.15 | 21.75 | 0.5 | 8 |
| TM1-0830PET | \$272 | 2.68 | 0.18 | 27.5  | 0.5 | 8 |
| TM1-0836PET | \$292 | 3.08 | 0.22 | 31.5  | 0.5 | 8 |
| TM1-0842PET | \$316 | 3.46 | 0.26 | 37.5  | 0.5 | 8 |
| TM1-0848PET | \$328 | 3.85 | 0.29 | 43.5  | 0.5 | 8 |

3 TOP MOUNT BRACKETS

|             |       |      |      |       |     |   |
|-------------|-------|------|------|-------|-----|---|
| TM1-0854PET | \$373 | 4.23 | 0.33 | 49.25 | 0.5 | 8 |
| TM1-0860PET | \$410 | 4.63 | 0.37 | 55.25 | 0.5 | 8 |
| TM1-0866PET | \$447 | 5    | 0.4  | 61.25 | 0.5 | 8 |
| TM1-0872PET | \$475 | 5.36 | 0.44 | 67    | 0.5 | 8 |
| TM1-0878PET | \$517 | 5.75 | 0.48 | 73    | 0.5 | 8 |

4 TOP MOUNT BRACKETS

|             |       |      |      |       |     |   |
|-------------|-------|------|------|-------|-----|---|
| TM1-0884PET | \$567 | 6.15 | 0.52 | 78.75 | 0.5 | 8 |
| TM1-0890PET | \$602 | 6.55 | 0.56 | 84.75 | 0.5 | 8 |
| TM1-0896PET | \$637 | 6.95 | 0.6  | 90.75 | 0.5 | 8 |

AVAILABLE BRACKET FINISH: BLACK (BL) OR SILVER (SL)

AVAILABLE PANEL FINISH: CHARCOAL GREY (CH) & STORM GREY (ST)

### 15" TOP MOUNT ACOUSTIC PET PRIVACY PANEL

ALL MOUNTING HARDWARE INCLUDED

2 TOP MOUNT BRACKETS

|             |       |      |      |       |     |    |
|-------------|-------|------|------|-------|-----|----|
| TM1-1524PET | \$280 | 3.41 | 0.24 | 21.75 | 0.5 | 15 |
| TM1-1530PET | \$290 | 4.15 | 0.29 | 27.5  | 0.5 | 15 |
| TM1-1536PET | \$310 | 4.88 | 0.36 | 31.5  | 0.5 | 15 |
| TM1-1542PET | \$334 | 5.65 | 0.42 | 37.5  | 0.5 | 15 |
| TM1-1548PET | \$346 | 6.33 | 0.48 | 43.5  | 0.5 | 15 |

3 TOP MOUNT BRACKETS

|             |       |      |      |       |     |    |
|-------------|-------|------|------|-------|-----|----|
| TM1-1554PET | \$391 | 7.05 | 0.54 | 49.25 | 0.5 | 15 |
| TM1-1560PET | \$428 | 7.78 | 0.61 | 55.25 | 0.5 | 15 |
| TM1-1566PET | \$465 | 8.5  | 0.66 | 61.25 | 0.5 | 15 |
| TM1-1572PET | \$493 | 9.23 | 0.73 | 67    | 0.5 | 15 |
| TM1-1578PET | \$535 | 9.95 | 0.79 | 73    | 0.5 | 15 |

4 TOP MOUNT BRACKETS

|             |       |       |      |       |     |    |
|-------------|-------|-------|------|-------|-----|----|
| TM1-1584PET | \$585 | 10.67 | 0.85 | 78.75 | 0.5 | 15 |
| TM1-1590PET | \$620 | 11.39 | 0.91 | 84.75 | 0.5 | 15 |
| TM1-1596PET | \$655 | 12.12 | 0.98 | 90.75 | 0.5 | 15 |

AVAILABLE BRACKET FINISH: BLACK (BL) OR SILVER (SL)

AVAILABLE PANEL FINISH: CHARCOAL GREY (CH) & STORM GREY (ST)

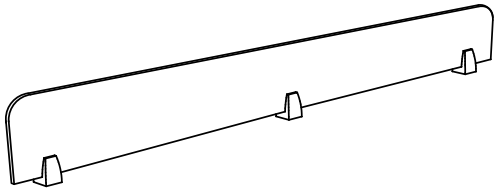

TM1-0872PET

RTA

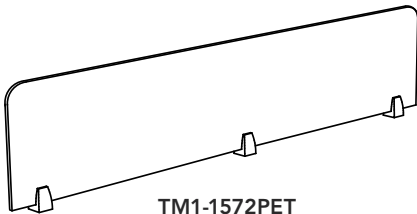

TM1-1572PET

RTA



| MODEL | LIST | WEIGHT | CUBE            | W  | D  | H  |
|-------|------|--------|-----------------|----|----|----|
|       |      | LBS    | FT <sup>3</sup> | IN | IN | IN |

**22" TOP MOUNT ACOUSTIC PET PRIVACY PANEL**

ALL MOUNTING HARDWARE INCLUDED

2 TOP MOUNT BRACKETS

|             |       |      |      |       |     |    |
|-------------|-------|------|------|-------|-----|----|
| TM1-2524PET | \$350 | 4.55 | 0.33 | 21.75 | 0.5 | 24 |
| TM1-2530PET | \$362 | 5.62 | 0.41 | 27.5  | 0.5 | 24 |
| TM1-2536PET | \$380 | 6.67 | 0.5  | 31.5  | 0.5 | 24 |
| TM1-2542PET | \$402 | 7.74 | 0.58 | 37.5  | 0.5 | 24 |
| TM1-2548PET | \$495 | 8.81 | 0.67 | 43.5  | 0.5 | 24 |

3 TOP MOUNT BRACKETS

|             |       |       |      |       |     |    |
|-------------|-------|-------|------|-------|-----|----|
| TM1-2554PET | \$530 | 9.86  | 0.75 | 49.25 | 0.5 | 24 |
| TM1-2560PET | \$585 | 10.94 | 0.84 | 55.25 | 0.5 | 24 |
| TM1-2566PET | \$610 | 11.99 | 0.92 | 61.25 | 0.5 | 24 |
| TM1-2572PET | \$625 | 13.06 | 1.01 | 67    | 0.5 | 24 |
| TM1-2578PET | \$665 | 14.1  | 1.09 | 73    | 0.5 | 24 |

4 TOP MOUNT BRACKETS

|             |       |       |      |       |     |    |
|-------------|-------|-------|------|-------|-----|----|
| TM1-2584PET | \$680 | 15.18 | 1.18 | 78.75 | 0.5 | 24 |
| TM1-2590PET | \$705 | 16.25 | 1.27 | 84.75 | 0.5 | 24 |
| TM1-2596PET | \$728 | 17.3  | 1.35 | 90.75 | 0.5 | 24 |

AVAILABLE BRACKET FINISH: BLACK (BL) OR SILVER (SL)

AVAILABLE PANEL FINISH: CHARCOAL GREY (CH) & STORM GREY (ST)

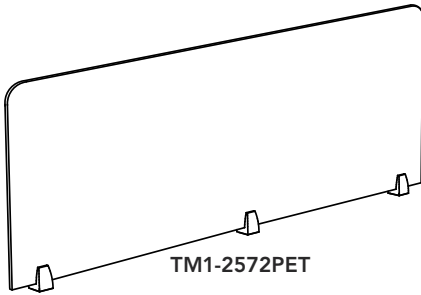

RTA

**8" EDGE MOUNT LAMINATE PRIVACY PANEL**

ALL MOUNTING HARDWARE INCLUDED. **FOR 1" THICK TOPS ONLY.**

2 EDGE MOUNTING BRACKETS

|             |       |       |       |       |      |   |
|-------------|-------|-------|-------|-------|------|---|
| EM1-0824LAP | \$171 | 6.56  | 0.08  | 19.75 | 0.75 | 8 |
| EM1-0830LAP | \$177 | 8.41  | 0.104 | 25.75 | 0.75 | 8 |
| EM1-0836LAP | \$183 | 10.27 | 0.127 | 31.5  | 0.75 | 8 |
| EM1-0842LAP | \$191 | 12.12 | 0.151 | 37.5  | 0.75 | 8 |
| EM1-0848LAP | \$197 | 13.98 | 0.175 | 43.5  | 0.75 | 8 |

3 EDGE MOUNTING BRACKETS

|             |       |       |       |       |      |   |
|-------------|-------|-------|-------|-------|------|---|
| EM1-0854LAP | \$214 | 15.83 | 0.199 | 49.25 | 0.75 | 8 |
| EM1-0860LAP | \$227 | 17.67 | 0.222 | 55.25 | 0.75 | 8 |
| EM1-0866LAP | \$240 | 19.54 | 0.246 | 61.25 | 0.75 | 8 |
| EM1-0872LAP | \$265 | 21.38 | 0.27  | 67    | 0.75 | 8 |
| EM1-0878LAP | \$288 | 23.25 | 0.294 | 73    | 0.75 | 8 |

4 EDGE MOUNTING BRACKETS

|             |       |       |       |       |      |   |
|-------------|-------|-------|-------|-------|------|---|
| EM1-0884LAP | \$312 | 25.09 | 0.317 | 78.75 | 0.75 | 8 |
| EM1-0890LAP | \$331 | 26.94 | 0.341 | 84.75 | 0.75 | 8 |
| EM1-0896LAP | \$342 | 28.8  | 0.365 | 90.75 | 0.75 | 8 |

AVAILABLE BRACKET FINISH: BLACK (BL) OR SILVER (SL)

AVAILABLE PANEL FINISH: ALL AVAILABLE HEARTWOOD LAMINATE FINISHES

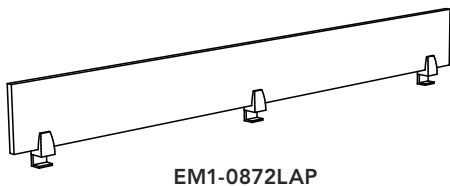

RTA

| MODEL | LIST | WEIGHT | CUBE            | W  | D  | H  |
|-------|------|--------|-----------------|----|----|----|
|       |      | LBS    | FT <sup>3</sup> | IN | IN | IN |

**15" EDGE MOUNT LAMINATE PRIVACY PANEL**

ALL MOUNTING HARDWARE INCLUDED. **FOR 1" THICK TOPS ONLY.**

2 EDGE MOUNTING BRACKETS

|             |       |       |       |       |      |    |
|-------------|-------|-------|-------|-------|------|----|
| EM1-1524LAP | \$188 | 11.97 | 0.148 | 19.75 | 0.75 | 15 |
| EM1-1530LAP | \$195 | 15.44 | 0.192 | 25.75 | 0.75 | 15 |
| EM1-1536LAP | \$201 | 18.92 | 0.237 | 31.5  | 0.75 | 15 |
| EM1-1542LAP | \$210 | 22.39 | 0.281 | 37.5  | 0.75 | 15 |
| EM1-1548LAP | \$218 | 25.87 | 0.325 | 43.5  | 0.75 | 15 |

3 EDGE MOUNTING BRACKETS

|             |       |       |       |       |      |    |
|-------------|-------|-------|-------|-------|------|----|
| EM1-1554LAP | \$235 | 29.34 | 0.369 | 49.25 | 0.75 | 15 |
| EM1-1560LAP | \$250 | 32.82 | 0.413 | 55.25 | 0.75 | 15 |
| EM1-1566LAP | \$262 | 36.29 | 0.457 | 61.25 | 0.75 | 15 |
| EM1-1572LAP | \$292 | 39.77 | 0.502 | 67    | 0.75 | 15 |
| EM1-1578LAP | \$317 | 43.23 | 0.546 | 73    | 0.75 | 15 |

4 EDGE MOUNTING BRACKETS

|             |       |       |       |       |      |    |
|-------------|-------|-------|-------|-------|------|----|
| EM1-1584LAP | \$342 | 46.72 | 0.59  | 78.75 | 0.75 | 15 |
| EM1-1590LAP | \$363 | 50.18 | 0.634 | 84.75 | 0.75 | 15 |
| EM1-1596LAP | \$377 | 53.67 | 0.678 | 90.75 | 0.75 | 15 |

AVAILABLE BRACKET FINISH: BLACK (BL) OR SILVER (SL)

AVAILABLE PANEL FINISH: ALL AVAILABLE HEARTWOOD LAMINATE FINISHES

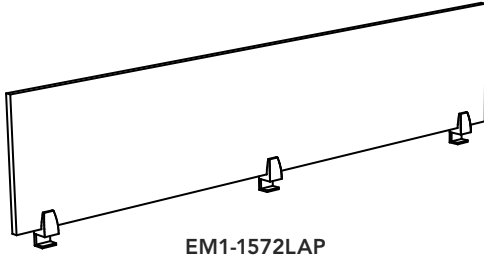

EM1-1572LAP

RTA

**22" EDGE MOUNT LAMINATE PRIVACY PANEL**

ALL MOUNTING HARDWARE INCLUDED. **FOR 1" THICK TOPS ONLY.**

2 EDGE MOUNTING BRACKETS

|             |       |       |       |       |      |       |
|-------------|-------|-------|-------|-------|------|-------|
| EM1-2224LAP | \$206 | 17.36 | 0.217 | 19.75 | 0.75 | 21.75 |
| EM1-2230LAP | \$215 | 22.47 | 0.281 | 25.75 | 0.75 | 21.75 |
| EM1-2236LAP | \$222 | 27.57 | 0.346 | 31.5  | 0.75 | 21.75 |
| EM1-2242LAP | \$230 | 32.66 | 0.41  | 37.5  | 0.75 | 21.75 |
| EM1-2248LAP | \$240 | 37.76 | 0.475 | 43.5  | 0.75 | 21.75 |

3 EDGE MOUNTING BRACKETS

|             |       |       |       |       |      |       |
|-------------|-------|-------|-------|-------|------|-------|
| EM1-2254LAP | \$259 | 42.87 | 0.54  | 49.25 | 0.75 | 21.75 |
| EM1-2260LAP | \$276 | 47.95 | 0.604 | 55.25 | 0.75 | 21.75 |
| EM1-2266LAP | \$288 | 53.05 | 0.669 | 61.25 | 0.75 | 21.75 |
| EM1-2272LAP | \$322 | 58.14 | 0.733 | 67    | 0.75 | 21.75 |
| EM1-2278LAP | \$351 | 63.24 | 0.798 | 73    | 0.75 | 21.75 |

4 EDGE MOUNTING BRACKETS

|             |       |       |       |       |      |       |
|-------------|-------|-------|-------|-------|------|-------|
| EM1-2284LAP | \$390 | 68.35 | 0.862 | 78.75 | 0.75 | 21.75 |
| EM1-2290LAP | \$426 | 73.43 | 0.927 | 84.75 | 0.75 | 21.75 |
| EM1-2296LAP | \$449 | 78.54 | 0.991 | 90.75 | 0.75 | 21.75 |

AVAILABLE BRACKET FINISH: BLACK (BL) OR SILVER (SL)

AVAILABLE PANEL FINISH: ALL AVAILABLE HEARTWOOD LAMINATE FINISHES

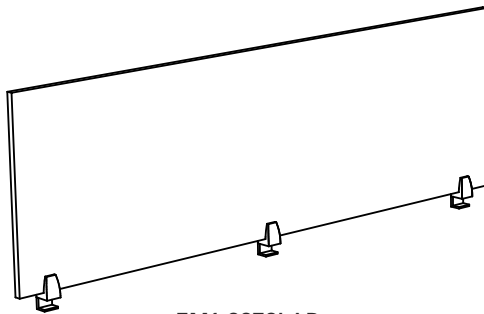

EM1-2272LAP

RTA

| MODEL | LIST | WEIGHT | CUBE            | W  | D  | H  |
|-------|------|--------|-----------------|----|----|----|
|       |      | LBS    | FT <sup>3</sup> | IN | IN | IN |

**8" EDGE MOUNT PLEXIGLASS PRIVACY PANEL**

ALL MOUNTING HARDWARE INCLUDED. **FOR 1" THICK TOPS ONLY.**

2 EDGE MOUNTING BRACKETS

|             |       |       |       |       |      |   |
|-------------|-------|-------|-------|-------|------|---|
| EM1-0824PLX | \$205 | 6.56  | 0.033 | 19.75 | 0.25 | 8 |
| EM1-0830PLX | \$224 | 8.41  | 0.042 | 25.75 | 0.25 | 8 |
| EM1-0836PLX | \$235 | 10.27 | 0.052 | 31.5  | 0.25 | 8 |
| EM1-0842PLX | \$241 | 12.12 | 0.062 | 37.5  | 0.25 | 8 |
| EM1-0848PLX | \$253 | 13.98 | 0.072 | 43.5  | 0.25 | 8 |

3 EDGE MOUNTING BRACKETS

|             |       |       |       |       |      |   |
|-------------|-------|-------|-------|-------|------|---|
| EM1-0854PLX | \$306 | 15.83 | 0.081 | 49.25 | 0.25 | 8 |
| EM1-0860PLX | \$332 | 17.67 | 0.091 | 55.25 | 0.25 | 8 |
| EM1-0866PLX | \$350 | 19.54 | 0.101 | 61.25 | 0.25 | 8 |
| EM1-0872PLX | \$378 | 21.38 | 0.11  | 67    | 0.25 | 8 |
| EM1-0878PLX | \$405 | 23.25 | 0.12  | 73    | 0.25 | 8 |

4 EDGE MOUNTING BRACKETS

|             |       |       |       |       |      |   |
|-------------|-------|-------|-------|-------|------|---|
| EM1-0884PLX | \$432 | 25.09 | 0.13  | 78.75 | 0.25 | 8 |
| EM1-0890PLX | \$480 | 26.94 | 0.14  | 84.75 | 0.25 | 8 |
| EM1-0896PLX | \$506 | 28.8  | 0.149 | 90.75 | 0.25 | 8 |

AVAILABLE BRACKET FINISH: BLACK (BL) OR SILVER (SL)

PLEXIGLASS FINISH: BRONZE (BR), CLEAR (CL) & FROSTED (FR)

**15" EDGE MOUNT PLEXIGLASS PRIVACY PANEL**

ALL MOUNTING HARDWARE INCLUDED. **FOR 1" THICK TOPS ONLY.**

2 EDGE MOUNTING BRACKETS

|             |       |       |       |       |      |    |
|-------------|-------|-------|-------|-------|------|----|
| EM1-1524PLX | \$412 | 11.97 | 0.061 | 19.75 | 0.25 | 15 |
| EM1-1530PLX | \$430 | 15.44 | 0.079 | 25.75 | 0.25 | 15 |
| EM1-1536PLX | \$441 | 18.92 | 0.097 | 31.5  | 0.25 | 15 |
| EM1-1542PLX | \$461 | 22.39 | 0.115 | 37.5  | 0.25 | 15 |
| EM1-1548PLX | \$477 | 25.87 | 0.133 | 43.5  | 0.25 | 15 |

3 EDGE MOUNTING BRACKETS

|             |       |       |       |       |      |    |
|-------------|-------|-------|-------|-------|------|----|
| EM1-1554PLX | \$497 | 29.34 | 0.151 | 49.25 | 0.25 | 15 |
| EM1-1560PLX | \$525 | 32.82 | 0.169 | 55.25 | 0.25 | 15 |
| EM1-1566PLX | \$546 | 36.29 | 0.187 | 61.25 | 0.25 | 15 |
| EM1-1572PLX | \$605 | 39.77 | 0.205 | 67    | 0.25 | 15 |
| EM1-1578PLX | \$667 | 43.23 | 0.223 | 73    | 0.25 | 15 |

4 EDGE MOUNTING BRACKETS

|             |       |       |       |       |      |    |
|-------------|-------|-------|-------|-------|------|----|
| EM1-1584PLX | \$701 | 46.72 | 0.241 | 78.75 | 0.25 | 15 |
| EM1-1590PLX | \$725 | 50.18 | 0.259 | 84.75 | 0.25 | 15 |
| EM1-1596PLX | \$740 | 53.67 | 0.277 | 90.75 | 0.25 | 15 |

AVAILABLE BRACKET FINISH: BLACK (BL) OR SILVER (SL)

PLEXIGLASS FINISH: BRONZE (BR), CLEAR (CL) & FROSTED (FR)

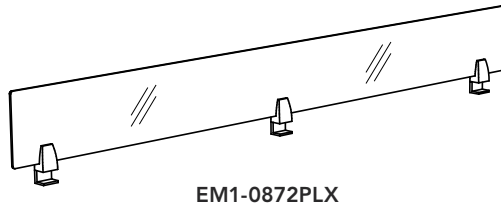

EM1-0872PLX

RTA

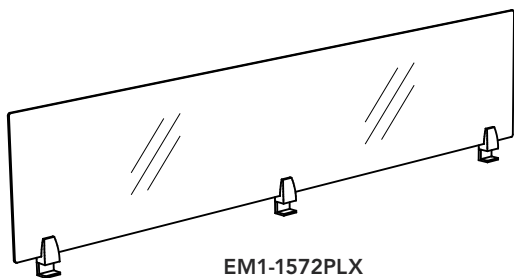

EM1-1572PLX

RTA

| MODEL | LIST | WEIGHT | CUBE            | W  | D  | H  |
|-------|------|--------|-----------------|----|----|----|
|       |      | LBS    | FT <sup>3</sup> | IN | IN | IN |

**8" EDGE MOUNT TACK BOARD PRIVACY PANEL**

ALL MOUNTING HARDWARE INCLUDED. FOR 1" THICK TOPS ONLY.

2 EDGE MOUNT BRACKETS

|             |       |      |      |       |   |   |
|-------------|-------|------|------|-------|---|---|
| EM1-0824TBP | \$413 | 2.95 | 0.16 | 19.75 | 1 | 8 |
| EM1-0830TBP | \$418 | 3.4  | 0.2  | 25.75 | 1 | 8 |
| EM1-0836TBP | \$432 | 3.81 | 0.24 | 31.5  | 1 | 8 |
| EM1-0842TBP | \$465 | 4.23 | 0.28 | 37.5  | 1 | 8 |
| EM1-0848TBP | \$499 | 4.67 | 0.32 | 43.5  | 1 | 8 |

3 EDGE MOUNT BRACKETS

|             |       |      |      |       |   |   |
|-------------|-------|------|------|-------|---|---|
| EM1-0854TBP | \$517 | 5.09 | 0.36 | 49.25 | 1 | 8 |
| EM1-0860TBP | \$659 | 5.53 | 0.4  | 55.25 | 1 | 8 |
| EM1-0866TBP | \$677 | 5.95 | 0.44 | 61.25 | 1 | 8 |
| EM1-0872TBP | \$687 | 6.40 | 0.48 | 67    | 1 | 8 |
| EM1-0878TBP | \$705 | 6.81 | 0.52 | 73    | 1 | 8 |

4 EDGE MOUNT BRACKETS

|             |       |      |      |       |   |   |
|-------------|-------|------|------|-------|---|---|
| EM1-0884TBP | \$748 | 7.25 | 0.56 | 78.75 | 1 | 8 |
| EM1-0890TBP | \$816 | 7.71 | 0.61 | 84.75 | 1 | 8 |
| EM1-0896TBP | \$855 | 8.11 | 0.65 | 90.75 | 1 | 8 |

AVAILABLE BRACKET FINISH: BLACK (BL) OR SILVER (SL)

AVAILABLE TACK BOARD FINISH: ALL ESCAPE TACK BOARD FABRICS.

**15" EDGE MOUNT TACK BOARD PRIVACY PANEL**

ALL MOUNTING HARDWARE INCLUDED. FOR 1" THICK TOPS ONLY.

2 EDGE MOUNTING BRACKETS

|             |       |      |      |       |   |    |
|-------------|-------|------|------|-------|---|----|
| EM1-1524TBP | \$436 | 4.21 | 0.26 | 19.75 | 1 | 15 |
| EM1-1530TBP | \$440 | 5.   | 0.32 | 25.75 | 1 | 15 |
| EM1-1536TBP | \$455 | 5.82 | 0.39 | 31.5  | 1 | 15 |
| EM1-1542TBP | \$491 | 6.61 | 0.46 | 37.5  | 1 | 15 |
| EM1-1548TBP | \$525 | 7.43 | 0.52 | 43.5  | 1 | 15 |

3 EDGE MOUNT BRACKETS

|             |       |       |      |       |   |    |
|-------------|-------|-------|------|-------|---|----|
| EM1-1554TBP | \$544 | 8.22  | 0.59 | 49.25 | 1 | 15 |
| EM1-1560TBP | \$694 | 9.04  | 0.66 | 55.25 | 1 | 15 |
| EM1-1566TBP | \$713 | 9.85  | 0.72 | 61.25 | 1 | 15 |
| EM1-1572TBP | \$731 | 10.69 | 0.79 | 67    | 1 | 15 |
| EM1-1578TBP | \$762 | 11.46 | 0.86 | 73    | 1 | 15 |

4 EDGE MOUNT BRACKETS

|             |       |       |      |       |   |    |
|-------------|-------|-------|------|-------|---|----|
| EM1-1584TBP | \$832 | 12.26 | 0.92 | 78.75 | 1 | 15 |
| EM1-1590TBP | \$906 | 13.07 | 0.99 | 84.75 | 1 | 15 |
| EM1-1596TBP | \$951 | 13.89 | 1.06 | 90.75 | 1 | 15 |

AVAILABLE BRACKET FINISH: BLACK (BL) OR SILVER (SL)

AVAILABLE TACK BOARD FINISH: ALL ESCAPE TACK BOARD FABRICS.

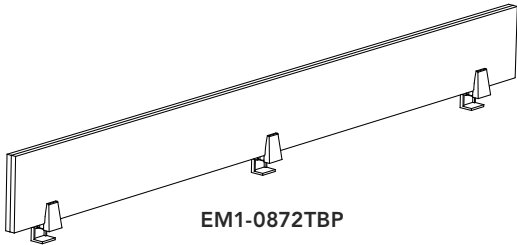

EM1-0872TBP

RTA

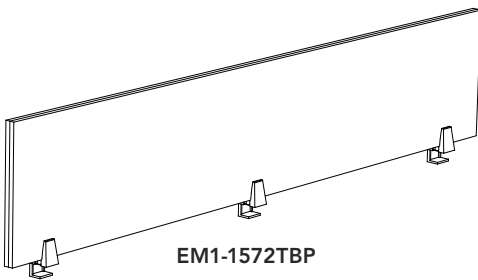

EM1-1572TBP

RTA

| MODEL | LIST | WEIGHT | CUBE            | W  | D  | H  |
|-------|------|--------|-----------------|----|----|----|
|       |      | LBS    | FT <sup>3</sup> | IN | IN | IN |

**22" EDGE MOUNT TACK BOARD PRIVACY PANEL**

ALL MOUNTING HARDWARE INCLUDED. FOR 1" THICK TOPS ONLY.

2 EDGE MOUNT BRACKETS

|             |       |       |      |       |   |       |
|-------------|-------|-------|------|-------|---|-------|
| EM1-2224TBP | \$544 | 5.47  | 0.36 | 19.75 | 1 | 21.75 |
| EM1-2230TBP | \$551 | 6.64  | 0.45 | 25.75 | 1 | 21.75 |
| EM1-2236TBP | \$569 | 7.83  | 0.54 | 31.5  | 1 | 21.75 |
| EM1-2242TBP | \$613 | 8.99  | 0.63 | 37.5  | 1 | 21.75 |
| EM1-2248TBP | \$657 | 10.19 | 0.73 | 43.5  | 1 | 21.75 |

3 EDGE MOUNT BRACKETS

|             |       |       |      |       |   |       |
|-------------|-------|-------|------|-------|---|-------|
| EM1-2254TBP | \$679 | 11.38 | 0.82 | 49.25 | 1 | 21.75 |
| EM1-2260TBP | \$833 | 12.54 | 0.91 | 55.25 | 1 | 21.75 |
| EM1-2266TBP | \$855 | 13.73 | 1    | 61.25 | 1 | 21.75 |
| EM1-2272TBP | \$871 | 14.90 | 1.1  | 67    | 1 | 21.75 |
| EM1-2278TBP | \$900 | 16.09 | 1.19 | 73    | 1 | 21.75 |

4 EDGE MOUNT BRACKETS

|             |         |       |      |       |   |       |
|-------------|---------|-------|------|-------|---|-------|
| EM1-2284TBP | \$956   | 17.26 | 1.28 | 78.75 | 1 | 21.75 |
| EM1-2290TBP | \$1,042 | 18.45 | 1.38 | 84.75 | 1 | 21.75 |
| EM1-2296TBP | \$1,093 | 19.64 | 1.47 | 90.75 | 1 | 21.75 |

AVAILABLE BRACKET FINISH: BLACK (BL) OR SILVER (SL)

AVAILABLE TACK BOARD FINISH: ALL ESCAPE TACK BOARD FABRICS.

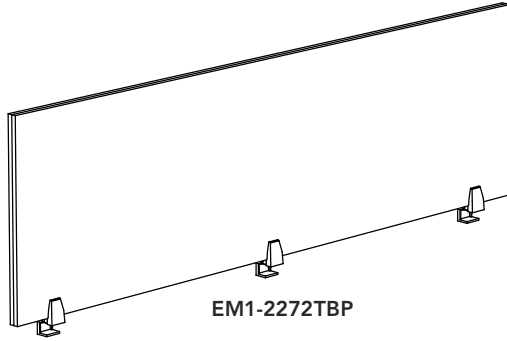

RTA

**8" EDGE MOUNT ACOUSTIC PET PRIVACY PANEL**

ALL MOUNTING HARDWARE INCLUDED. FOR 1" THICK TOPS ONLY.

2 EDGE MOUNT BRACKETS

|             |       |      |      |       |     |   |
|-------------|-------|------|------|-------|-----|---|
| EM1-0824PET | \$262 | 2.3  | 0.15 | 21.75 | 0.5 | 8 |
| EM1-0830PET | \$272 | 2.68 | 0.18 | 27.5  | 0.5 | 8 |
| EM1-0836PET | \$292 | 3.08 | 0.22 | 31.5  | 0.5 | 8 |
| EM1-0842PET | \$316 | 3.46 | 0.26 | 37.5  | 0.5 | 8 |
| EM1-0848PET | \$328 | 3.85 | 0.29 | 43.5  | 0.5 | 8 |

3 EDGE MOUNT BRACKETS

|             |       |      |      |       |     |   |
|-------------|-------|------|------|-------|-----|---|
| EM1-0854PET | \$373 | 4.23 | 0.33 | 49.25 | 0.5 | 8 |
| EM1-0860PET | \$410 | 4.63 | 0.37 | 55.25 | 0.5 | 8 |
| EM1-0866PET | \$447 | 5    | 0.4  | 61.25 | 0.5 | 8 |
| EM1-0872PET | \$475 | 5.36 | 0.44 | 67    | 0.5 | 8 |
| EM1-0878PET | \$517 | 5.75 | 0.48 | 73    | 0.5 | 8 |

4 EDGE MOUNT BRACKETS

|             |       |      |      |       |     |   |
|-------------|-------|------|------|-------|-----|---|
| EM1-0884PET | \$567 | 6.15 | 0.52 | 78.75 | 0.5 | 8 |
| EM1-0890PET | \$602 | 6.55 | 0.56 | 84.75 | 0.5 | 8 |
| EM1-0896PET | \$637 | 6.95 | 0.6  | 90.75 | 0.5 | 8 |

AVAILABLE BRACKET FINISH: BLACK (BL) OR SILVER (SL)

AVAILABLE PANEL FINISH: CHARCOAL GREY (CH) & STORM GREY (ST)

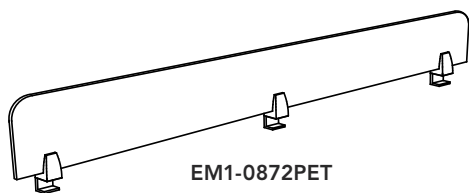

RTA

| MODEL | LIST | WEIGHT | CUBE            | W  | D  | H  |
|-------|------|--------|-----------------|----|----|----|
|       |      | LBS    | FT <sup>3</sup> | IN | IN | IN |

**15" EDGE MOUNT ACOUSTIC PET PRIVACY PANEL**

ALL MOUNTING HARDWARE INCLUDED. FOR 1" THICK TOPS ONLY.

2 EDGE MOUNT BRACKETS

|             |       |      |      |       |     |    |
|-------------|-------|------|------|-------|-----|----|
| EM1-1524PET | \$280 | 3.41 | 0.24 | 21.75 | 0.5 | 15 |
| EM1-1530PET | \$290 | 4.15 | 0.29 | 27.5  | 0.5 | 15 |
| EM1-1536PET | \$310 | 4.88 | 0.36 | 31.5  | 0.5 | 15 |
| EM1-1542PET | \$334 | 5.65 | 0.42 | 37.5  | 0.5 | 15 |
| EM1-1548PET | \$346 | 6.33 | 0.48 | 43.5  | 0.5 | 15 |

3 EDGE MOUNT BRACKETS

|             |       |      |      |       |     |    |
|-------------|-------|------|------|-------|-----|----|
| EM1-1554PET | \$391 | 7.05 | 0.54 | 49.25 | 0.5 | 15 |
| EM1-1560PET | \$428 | 7.78 | 0.61 | 55.25 | 0.5 | 15 |
| EM1-1566PET | \$465 | 8.5  | 0.66 | 61.25 | 0.5 | 15 |
| EM1-1572PET | \$493 | 9.23 | 0.73 | 67    | 0.5 | 15 |
| EM1-1578PET | \$535 | 9.95 | 0.79 | 73    | 0.5 | 15 |

4 EDGE MOUNT BRACKETS

|             |       |       |      |       |     |    |
|-------------|-------|-------|------|-------|-----|----|
| EM1-1584PET | \$585 | 10.67 | 0.85 | 78.75 | 0.5 | 15 |
| EM1-1590PET | \$620 | 11.39 | 0.91 | 84.75 | 0.5 | 15 |
| EM1-1596PET | \$655 | 12.12 | 0.98 | 90.75 | 0.5 | 15 |

AVAILABLE BRACKET FINISH: BLACK (BL) OR SILVER (SL)

AVAILABLE PANEL FINISH: CHARCOAL GREY (CH) & STORM GREY (ST)

**22" EDGE MOUNT ACOUSTIC PET PRIVACY PANEL**

ALL MOUNTING HARDWARE INCLUDED. FOR 1" THICK TOPS ONLY.

2 EDGE MOUNT BRACKETS

|             |       |      |      |       |     |    |
|-------------|-------|------|------|-------|-----|----|
| EM1-2524PET | \$350 | 4.55 | 0.33 | 21.75 | 0.5 | 24 |
| EM1-2530PET | \$362 | 5.62 | 0.41 | 27.5  | 0.5 | 24 |
| EM1-2536PET | \$380 | 6.67 | 0.5  | 31.5  | 0.5 | 24 |
| EM1-2542PET | \$402 | 7.74 | 0.58 | 37.5  | 0.5 | 24 |
| EM1-2548PET | \$495 | 8.81 | 0.67 | 43.5  | 0.5 | 24 |

3 EDGE MOUNT BRACKETS

|             |       |       |      |       |     |    |
|-------------|-------|-------|------|-------|-----|----|
| EM1-2554PET | \$530 | 9.86  | 0.75 | 49.25 | 0.5 | 24 |
| EM1-2560PET | \$585 | 10.94 | 0.84 | 55.25 | 0.5 | 24 |
| EM1-2566PET | \$610 | 11.99 | 0.92 | 61.25 | 0.5 | 24 |
| EM1-2572PET | \$625 | 13.06 | 1.01 | 67    | 0.5 | 24 |
| EM1-2578PET | \$665 | 14.1  | 1.09 | 73    | 0.5 | 24 |

4 EDGE MOUNT BRACKETS

|             |       |       |      |       |     |    |
|-------------|-------|-------|------|-------|-----|----|
| EM1-2584PET | \$680 | 15.18 | 1.18 | 78.75 | 0.5 | 24 |
| EM1-2590PET | \$705 | 16.25 | 1.27 | 84.75 | 0.5 | 24 |
| EM1-2596PET | \$728 | 17.3  | 1.35 | 90.75 | 0.5 | 24 |

AVAILABLE BRACKET FINISH: BLACK (BL) OR SILVER (SL)

AVAILABLE PANEL FINISH: CHARCOAL GREY (CH) & STORM GREY (ST)

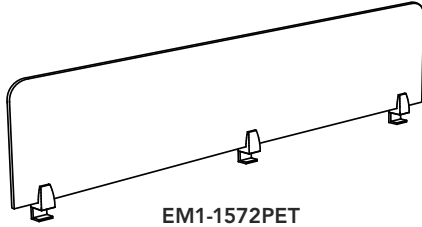

EM1-1572PET

RTA

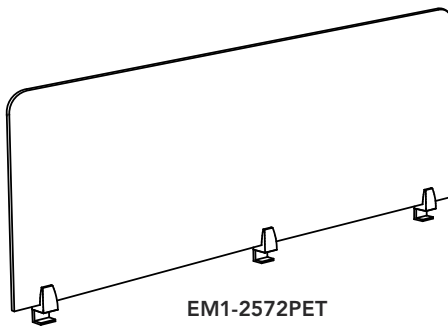

EM1-2572PET

RTA

| MODEL | LIST | WEIGHT | CUBE            | W  | D  | H  |
|-------|------|--------|-----------------|----|----|----|
|       |      | LBS    | FT <sup>3</sup> | IN | IN | IN |

REMOVABLE  
APPLICATION - NO  
DRILLING

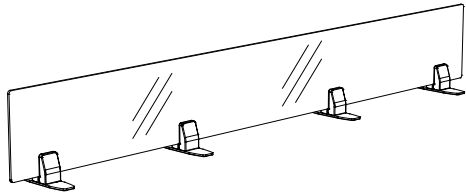

FS1-0860PLX

**8" FREE STANDING PLEXIGLASS PRIVACY PANEL**

PANELS REST ON THE WORK SURFACE AND ARE NOT ATTACHED. REMOVABLE PANELS, NO DRILLING.

2 WORK SURFACE ANTI-SLIP BRACKETS

|             |       |       |       |       |      |   |
|-------------|-------|-------|-------|-------|------|---|
| FS1-0824PLX | \$215 | 6.56  | 0.033 | 19.75 | 0.25 | 8 |
| FS1-0830PLX | \$235 | 8.41  | 0.042 | 25.75 | 0.25 | 8 |
| FS1-0836PLX | \$246 | 10.27 | 0.052 | 31.5  | 0.25 | 8 |
| FS1-0842PLX | \$251 | 12.12 | 0.062 | 37.5  | 0.25 | 8 |
| FS1-0848PLX | \$264 | 13.98 | 0.072 | 43.5  | 0.25 | 8 |

4 WORK SURFACE ANTI-SLIP BRACKETS

|             |       |       |       |       |      |   |
|-------------|-------|-------|-------|-------|------|---|
| FS1-0854PLX | \$317 | 15.83 | 0.081 | 49.25 | 0.25 | 8 |
| FS1-0860PLX | \$343 | 17.67 | 0.091 | 55.25 | 0.25 | 8 |
| FS1-0866PLX | \$361 | 19.54 | 0.101 | 61.25 | 0.25 | 8 |
| FS1-0872PLX | \$389 | 21.38 | 0.11  | 67    | 0.25 | 8 |

AVAILABLE BRACKET FINISH: SILVER (SL)

PLEXIGLASS FINISH: BRONZE (BR), CLEAR (CL) & FROSTED (FR)

RTA

**15" FREE STANDING PLEXIGLASS PRIVACY PANEL**

PANELS REST ON THE WORK SURFACE AND ARE NOT ATTACHED. REMOVABLE PANELS, NO DRILLING.

2 WORK SURFACE ANTI-SLIP BRACKETS

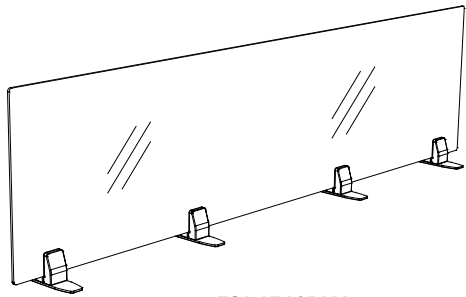

FS1-1560PLX

|             |       |       |       |       |      |    |
|-------------|-------|-------|-------|-------|------|----|
| FS1-1524PLX | \$423 | 11.97 | 0.061 | 19.75 | 0.25 | 15 |
| FS1-1530PLX | \$441 | 15.44 | 0.079 | 25.75 | 0.25 | 15 |
| FS1-1536PLX | \$453 | 18.92 | 0.097 | 31.5  | 0.25 | 15 |
| FS1-1542PLX | \$472 | 22.39 | 0.115 | 37.5  | 0.25 | 15 |
| FS1-1548PLX | \$489 | 25.87 | 0.133 | 43.5  | 0.25 | 15 |

4 WORK SURFACE ANTI-SLIP BRACKETS

|             |       |       |       |       |      |    |
|-------------|-------|-------|-------|-------|------|----|
| FS1-1554PLX | \$508 | 29.34 | 0.151 | 49.25 | 0.25 | 15 |
| FS1-1560PLX | \$536 | 32.82 | 0.169 | 55.25 | 0.25 | 15 |
| FS1-1566PLX | \$558 | 36.29 | 0.187 | 61.25 | 0.25 | 15 |
| FS1-1572PLX | \$616 | 39.77 | 0.205 | 67    | 0.25 | 15 |

AVAILABLE BRACKET FINISH: SILVER (SL)

PLEXIGLASS FINISH: BRONZE (BR), CLEAR (CL) & FROSTED (FR)

RTA

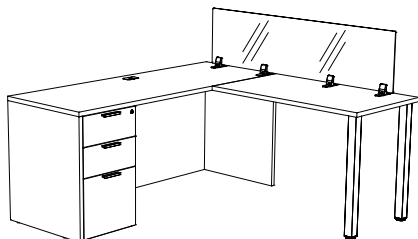

FS1-1560PLX SURFACE MOUNT  
EXAMPLE

| MODEL | LIST | WEIGHT | CUBE            | W  | D  | H  |
|-------|------|--------|-----------------|----|----|----|
|       |      | LBS    | FT <sup>3</sup> | IN | IN | IN |

**PLEXIGLASS PANEL EXTENSION**

ALL MOUNTING HARDWARE INCLUDED

**2 TOP MOUNTING BRACKETS**

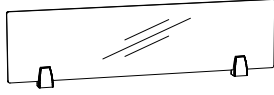

FRM-1030PLX

|              |       |     |      |       |     |      |
|--------------|-------|-----|------|-------|-----|------|
| FRM1-1024PLX | \$213 | 3.2 | 0.1  | 23.25 | .25 | 9.75 |
| FRM1-1030PLX | \$233 | 3.8 | 0.12 | 29.25 | .25 | 9.75 |
| FRM1-1036PLX | \$245 | 4.3 | 0.14 | 35    | .25 | 9.75 |
| FRM1-1042PLX | \$250 | 4.7 | 0.15 | 41    | .25 | 9.75 |
| FRM1-1048PLX | \$264 | 5.3 | 0.17 | 47    | .25 | 9.75 |

**3 TOP MOUNTING BRACKETS**

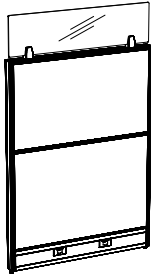

PANEL MOUNT

|              |       |     |      |       |      |      |
|--------------|-------|-----|------|-------|------|------|
| FRM1-1054PLX | \$319 | 5.8 | 0.19 | 52.75 | 0.25 | 9.75 |
| FRM1-1060PLX | \$346 | 6.2 | 0.21 | 58.75 | 0.25 | 9.75 |
| FRM1-1066PLX | \$365 | 6.6 | 0.23 | 64.5  | 0.25 | 9.75 |
| FRM1-1072PLX | \$394 | 7.1 | 0.25 | 70.5  | 0.25 | 9.75 |
| FRM1-1078PLX | \$422 | 7.5 | 0.27 | 76.5  | 0.25 | 9.75 |

**4 TOP MOUNTING BRACKETS**

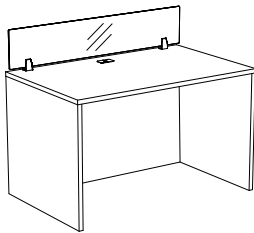

WORK SURFACE  
MOUNT

|              |       |     |      |       |      |      |
|--------------|-------|-----|------|-------|------|------|
| FRM1-1084PLX | \$451 | 8.6 | 0.29 | 82.25 | 0.25 | 9.75 |
| FRM1-1090PLX | \$500 | 9.0 | 0.31 | 88.25 | 0.25 | 9.75 |
| FRM1-1096PLX | \$527 | 9.4 | 0.33 | 94.25 | 0.25 | 9.75 |

**PANEL FINISH:** FROSTED (FR) OR CLEAR (CL) PLEXIGLASS

**BRACKET FINISHES:** SILVER (SL) OR BLACK (BL). DEFAULT FINISH WILL BE SILVER UNLESS OTHERWISE SPECIFIED

**NOTE:** CAN BE INSTALLED ON 48" OR 66" HIGH FRAMEWORK MODULAR PANELS, ON THIRD PARTY MODULAR PANEL DESIGNS OR USED IN WORK SURFACE MOUNT APPLICATIONS.

See **Protective Health Guard Series** for tempered glass panel extension options **OUT-70**



| MODEL | LIST | WEIGHT | CUBE            | W  | D  | H  |
|-------|------|--------|-----------------|----|----|----|
|       |      | LBS    | FT <sup>3</sup> | IN | IN | IN |

**LAMINATE MODESTY PANEL/DIVIDERS - SUSPENDED**

ALL MOUNTING HARDWARE INCLUDED

2 BRACKETS

|             |       |       |      |       |      |       |
|-------------|-------|-------|------|-------|------|-------|
| MDS-2430LAP | \$337 | 22.47 | 0.42 | 27.5  | 0.75 | 23.75 |
| MDS-2436LAP | \$355 | 27.57 | 0.5  | 31.5  | 0.75 | 23.75 |
| MDS-2442LAP | \$377 | 32.66 | 0.58 | 37.5  | 0.75 | 23.75 |
| MDS-2448LAP | \$470 | 37.76 | 0.67 | 43.23 | 0.75 | 23.75 |

3 BRACKETS

|             |       |       |      |       |      |       |
|-------------|-------|-------|------|-------|------|-------|
| MDS-2454LAP | \$505 | 42.87 | 0.75 | 49.25 | 0.75 | 23.75 |
| MDS-2460LAP | \$560 | 47.95 | 0.83 | 55    | 0.75 | 23.75 |
| MDS-2466LAP | \$585 | 53.05 | 0.92 | 61    | 0.75 | 23.75 |
| MDS-2472LAP | \$600 | 58.14 | 1    | 67    | 0.75 | 23.75 |

- PANELS ≤ 30" ARE INSET 1" ON EITHER END
- PANELS > 30" ARE INSET 2" ON EITHER END
- PANELS ≤ 48" HAVE THEIR BRACKETS INSET 2" FROM THE EDGE OF THE PANEL
- PANELS > 48" HAVE THEIR BRACKETS INSET 8" FROM THE EDGE OF THE PANEL

AVAILABLE BRACKET FINISH: BLACK (BL) OR SILVER (SL)

AVAILABLE PANEL FINISH: ALL AVAILABLE HEARTWOOD LAMINATE FINISHES

**PLEXIGLASS MODESTY PANEL/DIVIDERS - SUSPENDED**

ALL MOUNTING HARDWARE INCLUDED

2 BRACKETS

|             |       |       |      |       |      |       |
|-------------|-------|-------|------|-------|------|-------|
| MDS-2430PLX | \$462 | 16.15 | 0.21 | 27.5  | 0.25 | 23.75 |
| MDS-2436PLX | \$480 | 17.70 | 0.25 | 31.5  | 0.25 | 23.75 |
| MDS-2442PLX | \$502 | 19.24 | 0.29 | 37.5  | 0.25 | 23.75 |
| MDS-2448PLX | \$595 | 20.79 | 0.34 | 43.25 | 0.25 | 23.75 |

3 BRACKETS

|             |       |       |      |       |      |       |
|-------------|-------|-------|------|-------|------|-------|
| MDS-2454PLX | \$630 | 26.54 | 0.38 | 49.25 | 0.25 | 23.75 |
| MDS-2460PLX | \$685 | 28.09 | 0.42 | 55    | 0.25 | 23.75 |
| MDS-2466PLX | \$710 | 29.64 | 0.46 | 61    | 0.25 | 23.75 |
| MDS-2472PLX | \$725 | 31.19 | 0.5  | 67    | 0.25 | 23.75 |

- PANELS ≤ 30" ARE INSET 1" ON EITHER END
- PANELS > 30" ARE INSET 2" ON EITHER END
- PANELS ≤ 48" HAVE THEIR BRACKETS INSET 2" FROM THE EDGE OF THE PANEL
- PANELS > 48" HAVE THEIR BRACKETS INSET 8" FROM THE EDGE OF THE PANEL

AVAILABLE BRACKET FINISH: BLACK (BL) OR SILVER (SL)

AVAILABLE PLEXIGLASS FINISH: BRONZE (BR), CLEAR (CL), & FROSTED (FR)

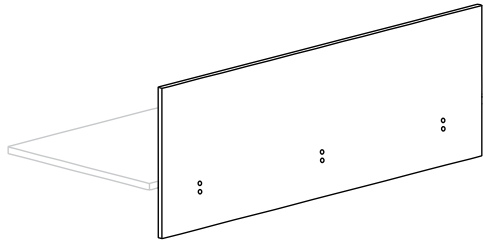

MDS-2472LAP  
ON A FLXS-REC3072

RTA

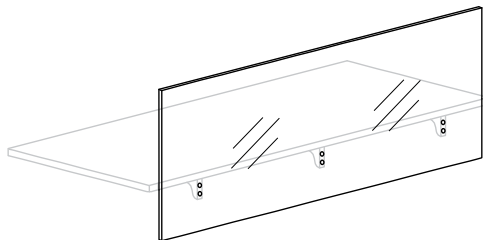

MDS-2472PLX  
ON A FLXS-REC3072

RTA

| MODEL | LIST | WEIGHT | CUBE            | W  | D  | H  |
|-------|------|--------|-----------------|----|----|----|
|       |      | LBS    | FT <sup>3</sup> | IN | IN | IN |

**TACK BOARD MODESTY PANEL/DIVIDERS - SUSPENDED**

ALL MOUNTING HARDWARE INCLUDED

2 BRACKETS

|             |       |      |      |       |   |       |
|-------------|-------|------|------|-------|---|-------|
| MDS-2430TBP | \$537 | 6.24 | 0.52 | 27.5  | 1 | 23.75 |
| MDS-2436TBP | \$555 | 7.41 | 0.63 | 31.5  | 1 | 23.75 |
| MDS-2442TBP | \$577 | 8.60 | 0.73 | 37.5  | 1 | 23.75 |
| MDS-2448TBP | \$670 | 9.79 | 0.83 | 43.25 | 1 | 23.75 |

3 BRACKETS

|             |       |       |      |       |   |       |
|-------------|-------|-------|------|-------|---|-------|
| MDS-2454TBP | \$705 | 10.96 | 0.94 | 49.25 | 1 | 23.75 |
| MDS-2460TBP | \$760 | 12.15 | 1.04 | 55    | 1 | 23.75 |
| MDS-2466TBP | \$785 | 13.32 | 1.14 | 61    | 1 | 23.75 |
| MDS-2472TBP | \$800 | 14.51 | 1.25 | 67    | 1 | 23.75 |

- PANELS ≤ 30" ARE INSET 1" ON EITHER END
- PANELS > 30" ARE INSET 2" ON EITHER END
- PANELS ≤ 48" HAVE THEIR BRACKETS INSET 2" FROM THE EDGE OF THE PANEL
- PANELS > 48" HAVE THEIR BRACKETS INSET 8" FROM THE EDGE OF THE PANEL

AVAILABLE BRACKET FINISH: BLACK (BL) OR SILVER (SL)

AVAILABLE TACK BOARD FINISH: ALL ESCAPE TACK BOARD FABRICS

**ACOUSTIC PET MODESTY PANEL/DIVIDERS - SUSPENDED**

ALL MOUNTING HARDWARE INCLUDED

2 BRACKETS

|             |       |      |      |       |     |       |
|-------------|-------|------|------|-------|-----|-------|
| MDS-2430PET | \$362 | 5.62 | 0.31 | 27.5  | 0.5 | 23.75 |
| MDS-2436PET | \$380 | 6.67 | 0.38 | 31.5  | 0.5 | 23.75 |
| MDS-2442PET | \$402 | 7.74 | 0.44 | 37.5  | 0.5 | 23.75 |
| MDS-2448PET | \$495 | 8.81 | 0.5  | 43.25 | 0.5 | 23.75 |

3 BRACKETS

|             |       |       |      |       |     |       |
|-------------|-------|-------|------|-------|-----|-------|
| MDS-2454PET | \$530 | 9.86  | 0.56 | 49.25 | 0.5 | 23.75 |
| MDS-2460PET | \$585 | 10.94 | 0.63 | 55    | 0.5 | 23.75 |
| MDS-2466PET | \$610 | 11.99 | 0.69 | 61    | 0.5 | 23.75 |
| MDS-2472PET | \$625 | 13.06 | 0.75 | 67    | 0.5 | 23.75 |

- PANELS ≤ 30" ARE INSET 1" ON EITHER END
- PANELS > 30" ARE INSET 2" ON EITHER END
- PANELS ≤ 48" HAVE THEIR BRACKETS INSET 2" FROM THE EDGE OF THE PANEL
- PANELS > 48" HAVE THEIR BRACKETS INSET 8" FROM THE EDGE OF THE PANEL

AVAILABLE BRACKET FINISH: BLACK (BL) OR SILVER (SL)

AVAILABLE PANEL FINISH: CHARCOAL GREY (CH) & STORM GREY (ST)

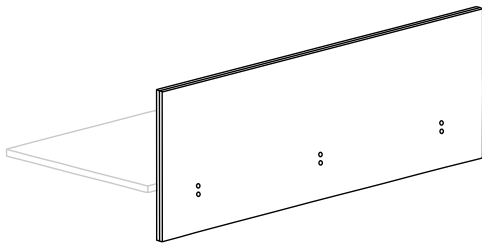

MDS-2472TBP  
ON A FLXS-REC3072

RTA

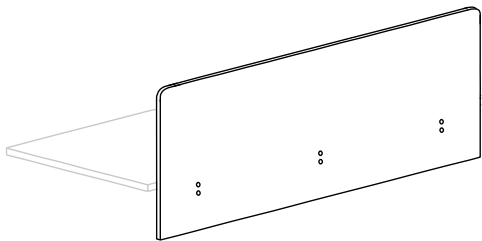

MDS-2472PET  
ON A FLXS-REC3072

RTA

| ITEMS | ITEM DESCRIPTION | QTY | 388 LIST |
|-------|------------------|-----|----------|
|-------|------------------|-----|----------|

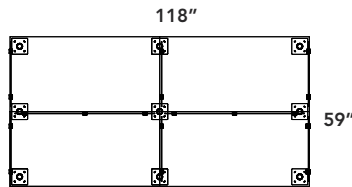
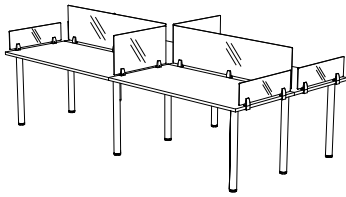

**LAYOUT 1 - TEAM STATION**

|              |  |    |                |
|--------------|--|----|----------------|
| EM1-0830PLX  | 8" EDGE MOUNT PLEXIGLASS PRIVACY PANEL | X4 | \$224          |
| TM1-1530PLX  | 15" TOP MOUNT PLEXIGLASS PRIVACY PANEL | X2 | \$430          |
| TM1-1560PLX  | 15" TOP MOUNT PLEXIGLASS PRIVACY PANEL | X2 | \$525          |
| FLXS-REC3060 | 30" RECTANGLE TOPS                     | X4 | \$384          |
| 900-RL2.5    | 2½" ROUND LEG                          | X9 | \$96           |
| <b>TOTAL</b> |  |    | <b>\$5,206</b> |

Factory installed 2" x 3" Grommet (**\$46** each list) available for FLEX series tops. Location of grommet/s must be specified with order.

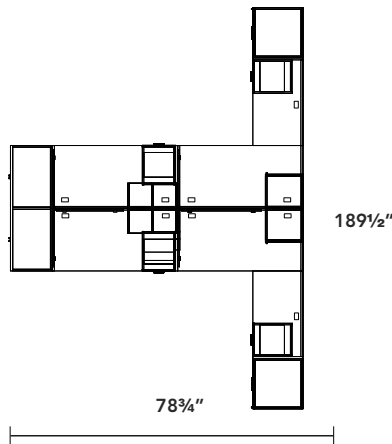
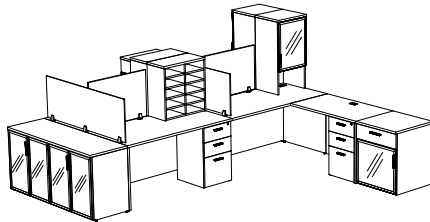

**LAYOUT 2**

|                        |  |    |                 |
|------------------------|--|----|-----------------|
| TM1-2236LAP            | 22" TOP MOUNT LAMINATE PRIVACY PANEL   |    | \$222           |
| TM1-2242LAP            | 22" TOP MOUNT LAMINATE PRIVACY PANEL   |    | \$230           |
| TM1-2260TBP            | 22" TOP MOUNT TACK BOARD PRIVACY PANEL | X2 | \$833           |
| 388-C2060C-AGD-FR      | CABINET CREDENZA                       |    | \$1,834         |
|                        | AGD UP-CHARGE                          |    | \$1,116         |
| 388-3060CT-B           | 30" CONNECTOR TOP                      | X4 | \$803           |
| 388-19FPUFX            | FREESTANDING PEDESTAL - NO TOP         | X4 | \$871           |
| 388-2424DCLH-AGD-FR    | SINGLE DOOR CABINET - DRAWER OVER DOOR |    | \$1,079         |
|                        | AGD UP-CHARGE                          |    | \$296           |
| 388-2424DCRH-AGD-FR    | SINGLE DOOR CABINET - DRAWER OVER DOOR |    | \$1,079         |
|                        | AGD UP-CHARGE                          |    | \$296           |
| 388-3618DTSHD-L-AGD-FR | DESKTOP STORAGE W/ HINGED DOORS        |    | \$601           |
|                        | AGD UP-CHARGE                          |    | \$418           |
| 388-3618DTSHD-R-AGD-FR | DESKTOP STORAGE W/ HINGED DOORS        |    | \$601           |
|                        | AGD UP-CHARGE                          |    | \$418           |
| 388-2442RS             | NON-HANDED RETURN SHELL                | X2 | \$639           |
| 388-2524DTO            | DESKTOP ORGANIZER                      | X2 | \$593           |
| <b>TOTAL</b>           |  |    | <b>\$19,016</b> |

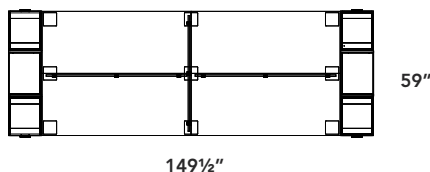
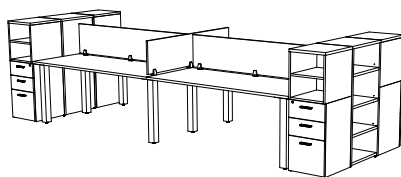

**LAYOUT 3**

|                |                                      |    |                 |
|----------------|--------------------------------------|----|-----------------|
| TM1-1560LAP    | 15" TOP MOUNT LAMINATE PRIVACY PANEL | X3 | \$250           |
| 388-19FPUFX    | FREESTANDING PEDESTAL - NO TOP       | X4 | \$871           |
| 388-1916SBK-19 | STACKING BOOKCASE                    | X4 | \$605           |
| C388-4722CO-16 | CUSTOM SIZE OPEN CABINET             | X2 | \$1,118         |
| FLXS-REC3060   | 30" RECTANGLE TOPS                   | X4 | \$384           |
| 900-SQ3        | 3" SQUARE LEG                        | X9 | \$151           |
| <b>TOTAL</b>   |                                      |    | <b>\$11,785</b> |

Factory installed 2" x 3" Grommet (**\$46** each list) available for FLEX series tops. Location of grommet/s must be specified with order.

| ITEMS | ITEM DESCRIPTION | QTY | 388 LIST |
|-------|------------------|-----|----------|
|-------|------------------|-----|----------|

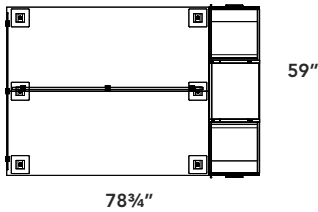
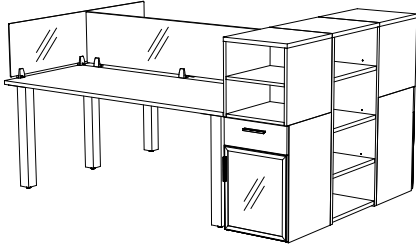

**LAYOUT 4**

|                      |   |    |                |
|----------------------|---|----|----------------|
| EM1-1560PLX          | 15" EDGE MOUNT PLEXIGLASS PRIVACY PANEL |    | \$525          |
| TM1-1560PLX          | 15" TOP MOUNT PLEXIGLASS PRIVACY PANEL  |    | \$525          |
| FLXS-REC3060         | 30" RECTANGLE TOPS                      | X2 | \$384          |
| 900-SQ3              | 3" SQUARE LEG                           | X6 | \$151          |
| 388-1918DCRHX-AGD-FR | CABINET - DRAWER OVER DOOR - NO TOP     |    | \$960          |
|                      | AGD UPCHARGE                            |    | \$277          |
| 388-1918DCLHX-AGD-FR | CABINET - DRAWER OVER DOOR - NO TOP     |    | \$960          |
|                      | AGD UPCHARGE                            |    | \$277          |
| C388-4722CO-16       | CUSTOM SIZE OPEN CABINET                |    | \$1,118        |
| C388-1918SBK-19      | CUSTOM SIZE STACKING BOOKCASE           | X2 | \$640          |
| <b>TOTAL</b>         |   |    | <b>\$7,596</b> |

Factory installed 2" x 3" Grommet (**\$46** each list) available for FLEX series tops. Location of grommet/s must be specified with order.

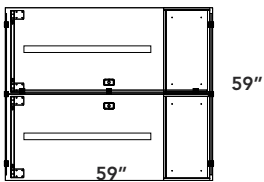
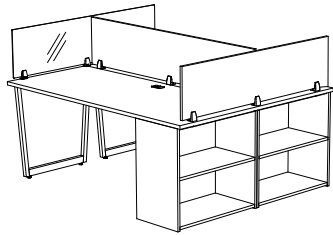

**LAYOUT 5**

|              |   |    |                |
|--------------|---|----|----------------|
| EM1-1560PLX  | 15" EDGE MOUNT PLEXIGLASS PRIVACY PANEL |    | \$525          |
| TM1-1560LAP  | 15" TOP MOUNT LAMINATE PRIVACY PANEL    | X2 | \$250          |
| WRK-3060WS   | 30" WORK SURFACE                        | X2 | \$384          |
| WRK-1630BKX  | OPEN BOOKCASE - NO TOP W/ 1 FIXED SHELF | X2 | \$636          |
| WRK-30MVLEG  | METAL V-LEG                             | X2 | \$250          |
| 100-WSB-40   | 40" STIFFENER BAR                       | X2 | \$82           |
| <b>TOTAL</b> |   |    | <b>\$3,729</b> |

Grommet location must be specified for Workspace work surfaces. See page [WRK-7](#)

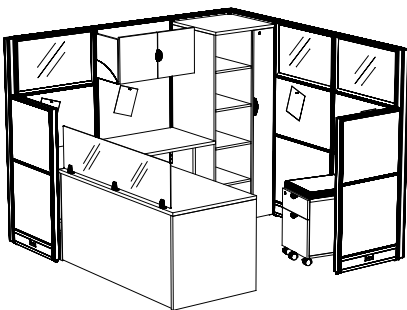

**LAYOUT 6**

**HEARTWOOD COMPONENTS**

|                                   |  |  |                |
|-----------------------------------|--|--|----------------|
| TM1-1560PLX                       | 15" TOP MOUNT PLEXIGLASS PRIVACY PANEL |  | \$525          |
| FRM-2460WS                        | WORK SURFACE                           |  | \$352          |
| FRM-1530OSHD                      | OVERHEAD STORAGE W/ HINGED DOORS       |  | \$753          |
| FRM-1622MPF                       | MOBILE BOX/FILE PEDESTAL               |  | \$794          |
| FRM-MPEDCUSH-ESC                  | MOBILE PEDESTAL CUSHION                |  | \$409          |
| FRM-WABK                          | WORK SURFACE ANGLE BRACKET KIT         |  | \$42           |
| FRM-WFBK                          | WORK SURFACE FLUSH BRACKET KIT         |  | \$38           |
| 388-6524OWR-24                    | OPEN WARDROBE STORAGE CABINETS         |  | \$1,408        |
| 388-3060CT-B                      | 30" CONNECTOR TOP                      |  | \$803          |
| <b>FURNITURE COMPONENT TOTAL=</b> |  |  | <b>\$5,124</b> |

CONTINUED...

| ITEMS | ITEM DESCRIPTION | QTY | 388 LIST |
|-------|------------------|-----|----------|
|-------|------------------|-----|----------|

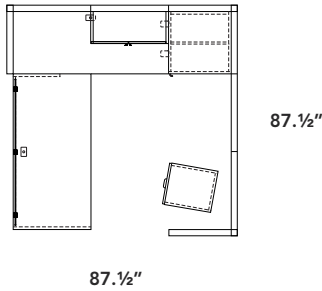

**HDL FRAMEWORK PANEL SYSTEM COMPONENTS**

|                        |                              |    |                |
|------------------------|------------------------------|----|----------------|
| FRM-2448P              | 48" TALL PANEL               | X2 | \$360          |
| FRM-3066GP             | 66" TALL CLEAR GLAZED PANEL  | X3 | \$673          |
| FRM-3066P              | 66" TALL PANEL               |    | \$509          |
| FRM-2466P              | 66" TALL PANEL               | X2 | \$457          |
| FRM-66SQP-2W           | SQUARE 2 WAY CONNECTING POST | X3 | \$109          |
| FRM-48PET              | PANEL END TRIM               | X2 | \$29           |
| FRM-PCK                | PANEL CONNECTING KIT         | X4 | \$40           |
| PANEL COMPONENT TOTAL= |                              |    | <b>\$4,707</b> |

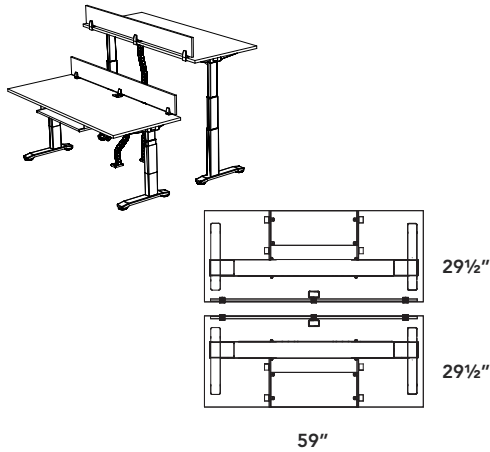

**LAYOUT 7**

|              |                                      |    |                |
|--------------|--------------------------------------|----|----------------|
| EM1-0866LAP  | 8" EDGE MOUNT LAMINATE PRIVACY PANEL | X2 | \$240          |
| CAL-E1-2LEG  | HEIGHT ADJUSTABLE 2 LEG BASE         | X2 | \$1,364        |
| CAL-REC3066  | 30" RECTANGLE TOP                    | X2 | \$439          |
| 100-WM1300-W | FLOOR WIRE MANAGEMENT                | X2 | \$127          |
| 100-KD28     | KEYBOARD DRAWER                      | X2 | \$202          |
| TOTAL        |                                      |    | <b>\$4,744</b> |

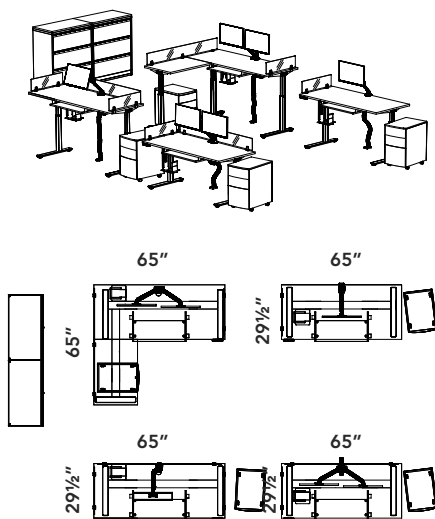

**LAYOUT 8**

**HEARTWOOD COMPONENTS**

|             |  |    |       |
|-------------|--|----|-------|
| EM1-0830PLX | 8" EDGE MOUNT PLEXIGLASS PRIVACY PANEL | X5 | \$224 |
| EM1-0866PLX | 8" EDGE MOUNT PLEXIGLASS PRIVACY PANEL | X3 | \$350 |

**HDL COMPONENTS**

|              |  |    |        |
|--------------|--|----|--------|
| ATH-E1-2LEG  | STRAIGHT ELECTRIC HEIGHT ADJUSTABLE 2 LEG BASE | X3 | \$1060 |
| ATH-E1-3LEG  | L SHAPED ELECTRIC HEIGHT ADJUSTABLE 3 LEG BASE |    | \$1527 |
| INV-3066TOP  | 66" RECTANGULAR TOP                            | X4 | \$366  |
| INV-2436TOP  | TOP ONLY                                       |    | \$99   |
| 100-2-HCPU   | HANGING CPU HOLDER                             | X4 | \$188  |
| 100-WM1300   | FLOOR WIRE MANAGEMENT                          | X4 | \$127  |
| 100-MA2      | PNEUMATIC LCD DUAL MONITOR ARM                 | X2 | \$436  |
| 100-MA1      | PNEUMATIC LCD SINGLE MONITOR ARM               | X2 | \$306  |
| 100-KD28     | KEYBOARD DRAWER                                | X4 | \$202  |
| 100-MMPUF    | METAL MOBILE PEDESTAL - FULL CARTON            | X4 | \$540  |
| 100-M1936LF3 | METAL 3 DRAWER LATERAL FILE                    | X2 | \$1278 |
| TTN-1936TOP  | LAMINATE TOP FOR METAL LATERAL FILES           | X2 | \$107  |

TOTAL **\$16,922**

| ITEMS | ITEM DESCRIPTION | QTY | 388 LIST |
|-------|------------------|-----|----------|
|-------|------------------|-----|----------|

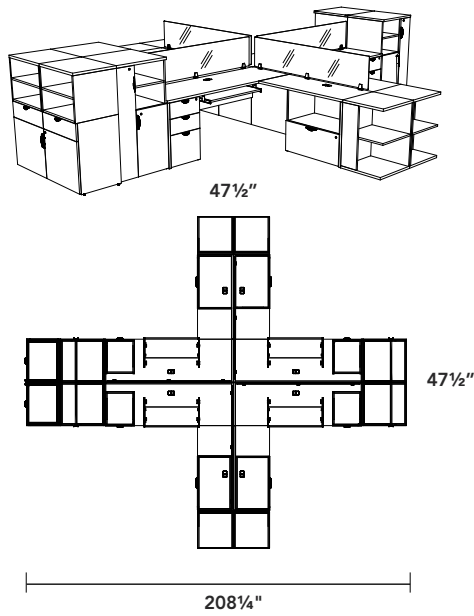

**LAYOUT 9**

|                 |  |    |                 |
|-----------------|--|----|-----------------|
| TM1-1572PLX     | 15" TOP MOUNT PLEXIGLASS PRIVACY PANEL | X4 | \$605           |
| 388-4724OCWL-24 | WARDROBE STORAGE CABINETS              | X2 | \$1,451         |
| 388-4724OCWR-24 | WARDROBE STORAGE CABINETS              | X2 | \$1,451         |
| 388-2048RS      | NON-HANDED RETURN SHELL                | X4 | \$606           |
| 388-2472CT -A2  | 24" CONNECTOR TOP                      | X4 | \$801           |
| 388-1924DCRHX   | CABINET - DRAWER OVER DOOR - NO TOP    |    | \$997           |
| 388-1924DCLHX   | CABINET - DRAWER OVER DOOR - NO TOP    |    | \$997           |
| 388-1924SBK-19  | STACKING BOOKCASE                      | X2 | \$640           |
| 388-19FPUFX     | FREESTANDING PEDESTAL - NO TOP         | X4 | \$871           |
| 388-1930OLFX    | OPEN LATERAL FILE STORAGE - NO TOP     | X4 | \$900           |
| 388-2920SCSL    | SQUARE CORNER SHELVES                  | X2 | \$525           |
| 388-2920SCSR    | SQUARE CORNER SHELVES                  | X2 | \$525           |
| 100-KD28        | KEYBOARD DRAWER                        | X4 | \$202           |
| <b>TOTAL</b>    |  |    | <b>\$27,118</b> |

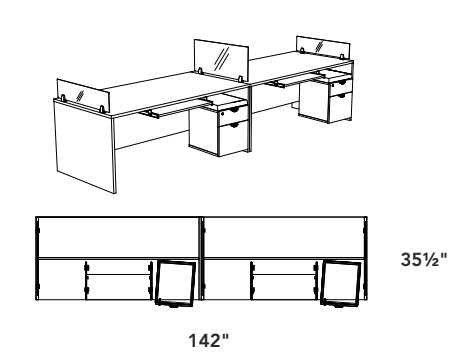

**LAYOUT 10**

|                  |  |    |                |
|------------------|--|----|----------------|
| TM1-0836PLX      | 8" TOP MOUNT PLEXIGLASS PRIVACY PANEL  | X2 | \$235          |
| TM1-1536PLX      | 15" TOP MOUNT PLEXIGLASS PRIVACY PANEL |    | \$441          |
| 388-3672DSM-3    | CENTER MODESTY DESK SHELL              | X2 | \$1,131        |
| 388-1622MPF      | MOBILE B/F PEDESTAL                    | x2 | \$834          |
| WRK-MPEDCUSH-ESC | PEDESTAL CUSHION                       | x2 | \$393          |
| 100-KD28         | KEYBOARD DRAWER                        | x2 | \$202          |
| <b>TOTAL</b>     |  |    | <b>\$6,031</b> |

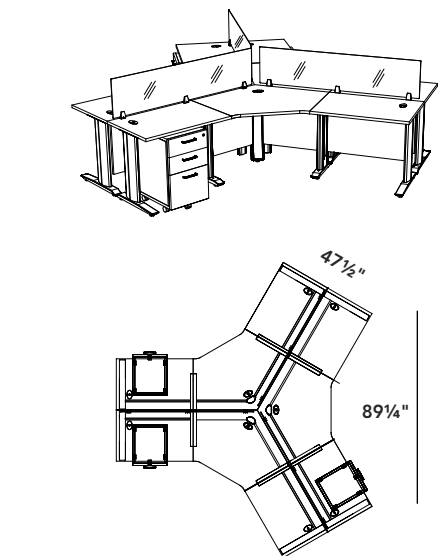

**LAYOUT 11**

|               |  |    |                 |
|---------------|--|----|-----------------|
| TM1-1566PLX   | 15" TOP MOUNT PLEXIGLASS PRIVACY PANEL | X3 | \$546           |
| 850-2436LC    | LEFT CONNECTOR                         | X3 | \$497           |
| 850-2430AC120 | 120° ANGLED CORNER MODULE              | X3 | \$919           |
| 850-2436RC    | RIGHT CONNECTOR                        | X3 | \$497           |
| 850-MPUF      | MOBILE BBF PEDESTAL                    | X3 | \$965           |
| <b>TOTAL</b>  |  |    | <b>\$10,272</b> |

|  | ITEMS            | ITEM DESCRIPTION                     | QTY   | 388 LIST       |                |
|--|------------------|--------------------------------------|-------|----------------|----------------|
|  | <b>LAYOUT 12</b> |                                      |       |                |                |
|  | TM1-1590LAP      | 15" TOP MOUNT LAMINATE PRIVACY PANEL |       | <b>\$363</b>   |                |
|  | 388-2472CT-A     | 24" CONNECTOR TOP                    |       | <b>\$801</b>   |                |
|  | 388-2448CT-C     | 24" CONNECTOR TOP                    |       | <b>\$672</b>   |                |
|  | 388-3672DS       | DESK SHELL, MP RECESSED 10" AT GABLE |       | <b>\$1,077</b> |                |
|  | 388-HPF          | HANGING PEDESTAL                     |       | <b>\$752</b>   |                |
|  | 388-4372HHD      | HUTCH W/ HINGED DOORS                |       | <b>\$1,526</b> |                |
|  | 388-4372TB       | TACK BOARD FOR 43" HUTCHES           |       | <b>\$387</b>   |                |
|  | 100-MA2          | PNEUMATIC LCD DUAL MONITOR ARM       |       | <b>\$436</b>   |                |
|  | 100-KB2          | ARTICULATING KEYBOARD TRAY           |       | <b>\$305</b>   |                |
|  |                  |                                      | TOTAL |                | <b>\$6,319</b> |

|            |                    |   |              |                 |
|------------|--------------------|---|--------------|-----------------|
|            | <b>LAYOUT 13</b>   |   |              |                 |
|            | EM1-1560PLX        | 15" EDGE MOUNT PLEXIGLASS PRIVACY PANEL | X2           | <b>\$525</b>    |
|            | EM1-0830PLX        | 8" EDGE MOUNT PLEXIGLASS PRIVACY PANEL  | X2           | <b>\$224</b>    |
|            | TM1-1530LAP        | 15" TOP MOUNT LAMINATE PRIVACY PANEL    | X2           | <b>\$195</b>    |
|            | FLXS-RECS3072      | 30" RECTANGLE SCOOPED TOPS              | X3           | <b>\$481</b>    |
|            | FLXS-REC2460       | 24" RECTANGLE TOPS                      | X2           | <b>\$337</b>    |
|            | 900-TAPERLEG       | STRAIGHT TAPERED LEG                    | X16          | <b>\$96</b>     |
|            | 900-50CASTER       | OPTIONAL CASTERS                        | X4           | <b>\$32</b>     |
|            | FLXS-MP60          | 12" HIGH MODESTY                        | X2           | <b>\$243</b>    |
|            | 388-1622MPF        | MOBILE B/F PEDESTAL                     | X3           | <b>\$834</b>    |
|            | WRK-MPEDCUSH-ESC   | PEDESTAL CUSHION                        | X3           | <b>\$393</b>    |
|            | 100-RECP-02        | POWER GROMMET                           | X2           | <b>\$888</b>    |
|            | 388-2436DC-AGD-FR  | DRAWERS OVER DOUBLE DOOR CABINETS       |              | <b>\$1,368</b>  |
|            |                    | AGD UPCHARGE                            |              | <b>\$532</b>    |
|            | 388-4336DTSHD-AGD  | DESKTOP STORAGE W/ HINGED DOORS         |              | <b>\$976</b>    |
|            |                    | AGD UPCHARGE                            |              | <b>\$629</b>    |
|            | 388-6524COCWL-24   | WARDROBE STORAGE CABINETS               |              | <b>\$1,813</b>  |
|            | 388-6524OWL-24     | OPEN WARDROBE STORAGE CABINETS          |              | <b>\$1,408</b>  |
|            | 100-MA2            | PNEUMATIC LCD DUAL MONITOR ARM          | X3           | <b>\$436</b>    |
|            | 388-1413VCI        | VERTICAL CUBBY INSERT                   |              | <b>\$257</b>    |
| 100-2-HCPU | HANGING CPU HOLDER | X3                                      | <b>\$188</b> |                 |
|            |                    | TOTAL                                   |              | <b>\$20,467</b> |

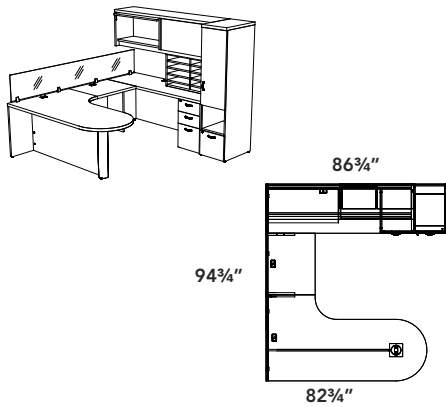

| ITEMS            | ITEM DESCRIPTION                       | QTY | 388 LIST |
|------------------|--|-----|----------|
| <b>LAYOUT 14</b> |  |     |          |
| TM1-1596PLX      | 15" TOP MOUNT PLEXIGLASS PRIVACY PANEL |     | \$740    |
| 600-8442RCMBTM5  | CORNER MODULE BULLET W/ 5" LEG         |     | \$2,417  |
| 600-2430CT-C     | 24" CONNECTOR TOP W/ C GABLES          |     | \$658    |
| 600-2472UF       | SINGLE RIGHT PEDESTAL CREDENZA         |     | \$1,916  |
| 600-1872OSFD     | OVERHEAD STORAGE - FLIPPER DOOR        |     | \$1,436  |
| 600-7216COF-R-24 | STORAGE CABINET                        |     | \$1,650  |
| 388-1836DTO      | DESKTOP ORGANIZER                      |     | \$603    |
|                  | TOTAL                                  |     | \$9,420  |

\* IMAGE SHOWS OPTIONAL VALENCE. ADD -V TO SKU AND \$218 TO PRICE IF VALENCE IS REQUIRED  
 \*\*LAYOUT SHOWS NON-FLUTED EDGE. PLEASE INDICATED ON YOUR PO IF FLUTING IS NOT REQUIRED

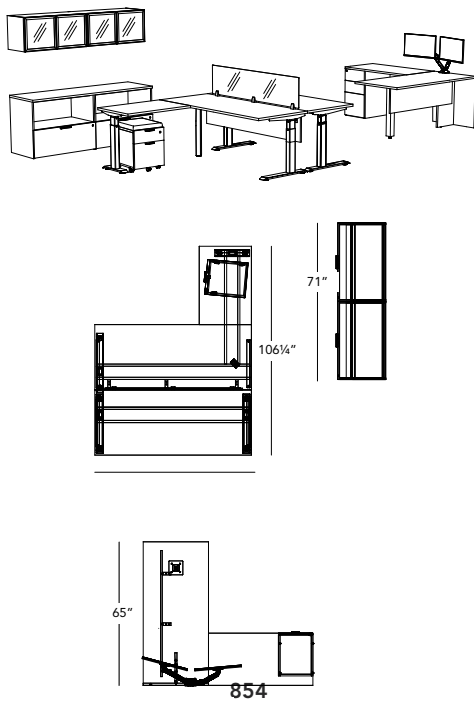

|                     |   |    |          |
|---------------------|---|----|----------|
| <b>LAYOUT 15</b>    |   |    |          |
| 388-1972FC          | FILE CABINET TOP                                |    | \$361    |
| 388-1936OLFX        | OPEN LATERAL FILE STORAGE - NO TOP              | X2 | \$962    |
| 388-1872OSHD-AGD-FR | OVERHEAD STORAGE WITH HINGED DOORS- FROSTED AGD |    | \$1,290  |
|                     | AGD UPCHARGE                                    |    | \$893    |
| CAL-E1-3LEG         | HEIGHT ADJUSTABLE 3 LEG BASE                    |    | \$1,988  |
| CAL-E1-2LEG         | HEIGHT ADJUSTABLE 2 LEG BASE                    |    | \$1,364  |
| 388-1622MPF         | MOBILE B/F PEDESTAL                             |    | \$834    |
| WRK-MPEDCUSH-ESC    | USE ON 21" HIGH MOBILE PEDESTALS                |    | \$393    |
| 388-3066RBTG        | RECTANGULAR BULLET TOP                          |    | \$888    |
| 388-19FPUFX         | FREESTANDING PEDESTAL - NO TOP                  |    | \$871    |
| FLXS-REC2448        | 24" RECTANGLE TOP                               |    | \$246    |
| CAL-REC3072         | 30" RECTANGLE TOP                               | X2 | \$453    |
| CAL-RS2448          | 24" RETURN TOP                                  |    | \$246    |
| CAL-MP1866LAP       | 18" LAMINATE MODESTY PANELS                     | X2 | \$282    |
| TM1-1566PLX         | 15" TOP MOUNT PLEXIGLASS PRIVACY PANEL          |    | \$546    |
| 100-MA2             | PNEUMATIC LCD DUAL MONITOR ARM                  |    | \$436    |
| WRK-WFBK            | WORK SURFACE FLUSH BRACKET KIT                  | X2 | \$36     |
|                     | TOTAL   |    | \$13,822 |



| ITEMS | ITEM DESCRIPTION | QTY | 388 LIST |
|-------|------------------|-----|----------|
|-------|------------------|-----|----------|

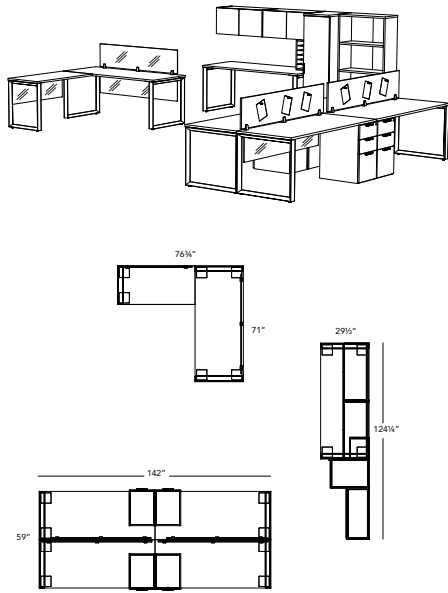

**LAYOUT #16**

|                  |  |    |                 |
|------------------|--|----|-----------------|
| FLXS-REC2448     | 24" RECTANGLE TOP                      |    | <b>\$246</b>    |
| 900-LOOP24       | METAL LOOP LEGS                        |    | <b>\$188</b>    |
| CAL-MP1642PLX    | 16" PLEXIGLASS HANGING MODESTY PANEL   |    | <b>\$346</b>    |
| FLXS-REC3072     | 30" RECTANGLE TOPS                     | X6 | <b>\$437</b>    |
| 900-LOOP30       | 30" METAL LOOP LEG                     | X8 | <b>\$207</b>    |
| WRK-WFBK         | WORK SURFACE FLUSH BRACKET KIT         |    | <b>\$36</b>     |
| CAL-MP1666PLX    | 16" PLEXIGLASS HANGING MODESTY PANEL   | X2 | <b>\$511</b>    |
| CAL-MP1672PLX    | 16" PLEXIGLASS HANGING MODESTY PANEL   |    | <b>\$538</b>    |
| 388-1872OSHD     | OVERHEAD STORAGE WITH HINGED DOORS     |    | <b>\$1,290</b>  |
| 388-1236VC       | VERTICAL CUBBY-HOLE                    |    | <b>\$384</b>    |
| 388-6518CLC-L-24 | SINGLE DOOR CLOSET CABINET             |    | <b>\$1,862</b>  |
| 388-6536BK       | BOOKCASE                               |    | <b>\$868</b>    |
| 388-19FPUFX      | FREESTANDING PEDESTAL - NO TOP         | X4 | <b>\$871</b>    |
| TM1-1572PLX      | 15" TOP MOUNT PLEXIGLASS PRIVACY PANEL |    | <b>\$605</b>    |
| TM1-1572TBP      | 15" TOP MOUNT TACK BOARD PRIVACY PANEL | X2 | <b>\$731</b>    |
| TOTAL            |  |    | <b>\$16,609</b> |

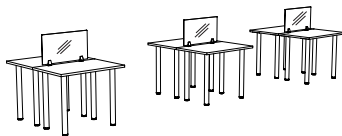

**LAYOUT #17**

|              |  |     |                |
|--------------|--|-----|----------------|
| FLXS-REC2436 | 24" RECTANGLE TOP                      | X6  | <b>\$204</b>   |
| 900-RL2.5    | 2 1/2" ROUND LEG                       | X24 | <b>\$96</b>    |
| TM1-1536PLX  | 15" TOP MOUNT PLEXIGLASS PRIVACY PANEL | X3  | <b>\$441</b>   |
| TOTAL        |  |     | <b>\$4,851</b> |

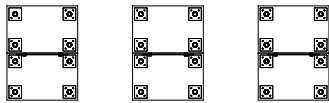

**Features and Specifications:**

- ♥ Silver finish steel powder coated support brackets for secure surface mount
- ♥ 3/16" clear plexi large front panel
- ♥ Soft corner detail
- ♥ Default sizing includes 5" high pass-through between surface underside of panel
- ♥ Allows for taller & wider sizing
- ♥ 2 minute install
- ♥ Best used for 24" - 48" high protection
- ♥ Alternate sizing available

**Finishes**

| Bracket Finishes |        |
|------------------|--------|
| ABBR             | COLOUR |
| SL               | Silver |

| Plexiglass Panel |        |
|------------------|--------|
| ABBR             | COLOUR |
| CL               | Clear  |

**Custom Sizes**

- ♥ Custom available.....call Customer Service. Please specify quote number when ordering. For Simple Width; changes, use the price of the next size up.

**Ordering Example :** To price a custom size panel PHG-3642BM-PLX **use the pricing for** PHG-3648BM-PLX

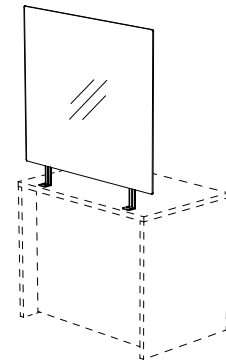

**Shipping**

- ♥ Some items are shipped fully assembled, some are shipped in RTA cartoning.
- Look for **RTA** symbol at each model number.

**Warranty**

- ♥ 5 year warranty

**NOTE:** Information is current at time of print. For up to date information check online at [WWW.HEARTWOOD.CA](http://WWW.HEARTWOOD.CA)

| MODEL | LIST | WEIGHT | CUBE            | W  | D  | H  |
|-------|------|--------|-----------------|----|----|----|
|       |      | LBS    | FT <sup>3</sup> | IN | IN | IN |

**SURFACE MOUNTED HEALTH GUARD**

BRACKET SURFACE MOUNT

|                |       |      |      |       |   |      |
|----------------|-------|------|------|-------|---|------|
| PHG-3636BM-PLX | \$557 | 15.9 | 1.71 | 35.5  | 2 | 35.5 |
| PHG-3648BM-PLX | \$576 | 19.0 | 2.2  | 47.25 | 2 | 35.5 |

PLEXIGLASS FINISH: CLEAR (CL)

BRACKET FINISH: SILVER (SL)

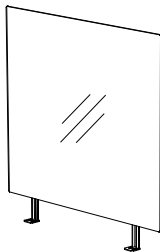

**RTA**

PHG-3648BM-PLX (SHOWN)

**Features and Specifications:**

- ♥ Silver finish steel powder coated support brackets for clamp mount & secure connection to 3/4" - 1 1/2" laminate surfaces
- ♥ 3/16" clear plexi large front panel
- ♥ Easy removal - no screw holes left on surfaces
- ♥ Soft corner detail
- ♥ Default sizing includes 5" high pass-through between surface & underside of panel
- ♥ Allows for taller & wider sizing
- ♥ 2 minute install
- ♥ Best used for 24" - 48" high protection
- ♥ Alternate sizing available

**Finishes**

| Bracket Finishes |        |
|------------------|--------|
| ABBR             | COLOUR |
| SL               | Silver |

| Plexiglass Panel |        |
|------------------|--------|
| ABBR             | COLOUR |
| CL               | Clear  |

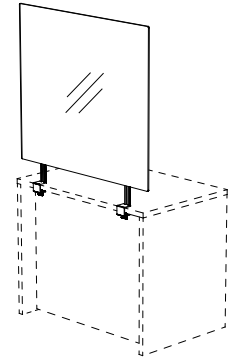

**Custom Sizes**

♥ Custom available.....call Customer Service. Please specify quote number when ordering. For Simple Width; changes, use the price of the next size up.

**Ordering Example:** To price a custom size panel PHG-3642BC-PLX use the pricing for PHG-3648BC-PLX

**Shipping**

♥ Some items are shipped fully assembled, some are shipped in RTA cartoning. Look for **RTA** symbol at each model number.

**Warranty**

♥ 5 year warranty

**NOTE:** Information is current at time of print. For up to date information check online at [WWW.HEARTWOOD.CA](http://WWW.HEARTWOOD.CA)

| MODEL | LIST | WEIGHT | CUBE            | W  | D  | H  |
|-------|------|--------|-----------------|----|----|----|
|       |      | LBS    | FT <sup>3</sup> | IN | IN | IN |

**REMOVABLE PROTECTIVE HEALTH GUARD**

BRACKET CLAMP MOUNT

|                |       |      |      |       |   |      |
|----------------|-------|------|------|-------|---|------|
| PHG-3636BC-PLX | \$557 | 16.4 | 1.71 | 35.5  | 2 | 35.5 |
| PHG-3648BC-PLX | \$576 | 19.5 | 2.2  | 47.25 | 2 | 35.5 |

PLEXIGLASS FINISH: CLEAR (CL)

BRACKET FINISH: SILVER (SL)

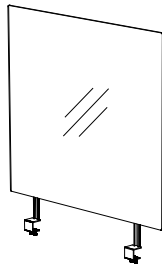

**RTA**

PHG-3648BC-PLX (SHOWN)

**Features and Specifications:**

- ♥ <sup>3</sup>/<sub>16</sub>" clear plexiglass
- ♥ Soft corner detail
- ♥ Includes 5" x 12" pass-through cut out (also available without pass through, same price)
- ♥ Easy to move around & easily removed
- ♥ Lowest cost panel option with 30 second install
- ♥ Maximum height of 32" recommended
- ♥ Alternate sizing available

**Custom Sizes**

- ♥ Custom available.....call Customer Service. Please specify quote number when ordering.

**Shipping**

- ♥ Some items are shipped fully assembled, some are shipped in RTA cartoning.
- Look for **RTA** symbol at each model number.

**Warranty**

- ♥ 5 year warranty

**NOTE:** Information is current at time of print. For up to date information check online at [WWW.HEARTWOOD.CA](http://WWW.HEARTWOOD.CA)

**Finishes**

| Plexiglass Panel |        |
|------------------|--------|
| ABBR             | COLOUR |
| CL               | Clear  |

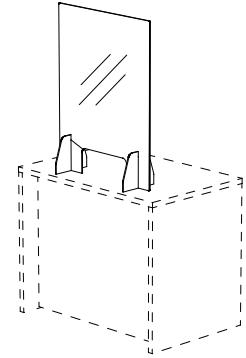

| MODEL | LIST | WEIGHT | CUBE            | W  | D  | H  |
|-------|------|--------|-----------------|----|----|----|
|       |      | LBS    | FT <sup>3</sup> | IN | IN | IN |

**FREESTANDING DESKTOP PROTECTIVE HEALTH GUARD**  
 PLEXIGLASS STAND

|                |       |      |      |       |   |      |
|----------------|-------|------|------|-------|---|------|
| PHG-3224FS-PLX | \$481 | 12.1 | 0.87 | 23.75 | 8 | 31.5 |
| PHG-3236FS-PLX | \$519 | 13.8 | 1.14 | 35.5  | 8 | 31.5 |
| PHG-3248FS-PLX | \$532 | 15   | 1.50 | 47.25 | 8 | 31.5 |

PLEXIGLASS FINISH: CLEAR (CL)

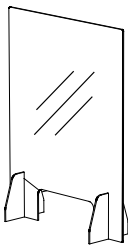

**RTA**

PHG-3224FS-PLX (SHOWN)

**Features and Specifications:**

- ♥ Freestanding partition for worksurface, includes levelers (improved stability by mounting to underside of worksurface)
- ♥ 3/16" clear plexiglass & 3/4" laminate construction, hardware included
- ♥ Soft corner detail on plexiglass
- ♥ Fits either 24" or 30" tops
- ♥ Easily removed
- ♥ Laminate base available in all standard Heartwood finishes with clear or frosted plexiglass topper
- ♥ Alternate sizing available

**Custom Sizes**

- ♥ Custom available.....call Customer Service. Please specify quote number when ordering. For Simple Width; changes, use the price of the next size up.

**Ordering Example:** To price a custom size panel PHG-4253DP-PLX use the pricing for PHG-4853DP-PLX

**Shipping**

- ♥ Some items are shipped fully assembled, some are shipped in RTA cartoning.
- Look for **RTA** symbol at each model number.

**Warranty**

- ♥ Limited Lifetime

**NOTE:** Information is current at time of print. For up to date information check online at [WWW.HEARTWOOD.CA](http://WWW.HEARTWOOD.CA)

**Finishes**

| Plexiglass Panel |         |
|------------------|---------|
| ABBR             | COLOUR  |
| CL               | Clear   |
| FR               | Frosted |

| ABBR | LAMINATE COLOUR    |
|------|--------------------|
| AM   | Autumn Maple       |
| BL   | Black              |
| BW   | Black Walnut       |
| CD   | Cappuccino Dream** |
| CM   | Charcoal Matrix    |
| DE   | Desert Sand        |
| DD   | Driftwood***       |
| DW   | Driftwood Grey**   |
| EZ   | Evening Zen        |
| GA   | Golden Ash         |
| GD   | Grey Dusk          |
| GM   | Grey Matrix        |
| GR   | Grey               |
| GT   | Graphite           |
| HM   | Hardrock Maple     |
| NC   | Noce Cocoa         |
| PW   | Pure White         |
| RM   | Royal Mahogany     |
| SM   | Sugar Maple        |
| SW   | Seaside White      |
| VA   | Volcanic Ash       |
| WW   | Winter Wood        |

\*\* Textured Finish  
\*\*\* Non-Textured Finish - 1" & 1½" laminate ONLY

**High Pressure (HP) laminate available Contact Customer Service.**

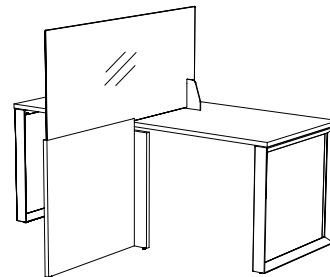

| MODEL | LIST | WEIGHT | CUBE            | W  | D  | H  |
|-------|------|--------|-----------------|----|----|----|
|       |      | LBS    | FT <sup>3</sup> | IN | IN | IN |

**DESK DIVIDER PANEL WITH PLEXIGLASS TOP**

FREESTANDING AND FITS EITHER 24" OR 30" DEEP TOPS

|                |              |      |      |   |       |       |
|----------------|--------------|------|------|---|-------|-------|
| PHG-4853DP-PLX | <b>\$744</b> | 33.1 | 1.29 | 8 | 47.25 | 52.25 |
| PHG-5453DP-PLX | <b>\$863</b> | 39.7 | 1.78 | 8 | 53.25 | 52.25 |

**PLEXIGLASS FINISH:** CLEAR (CL) OR FROSTED (FR)

**LAMINATE FINISHES:** ALL STANDARD HEARTWOOD LAMINATE FINISHES

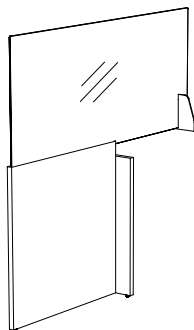

**RTA**

PHG-5453DP-PLX (SHOWN)

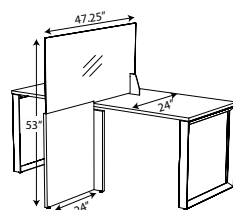

PHG-4853DP-PLX

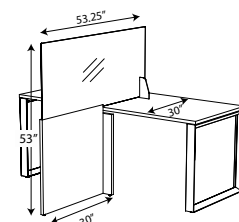
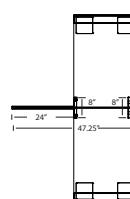

PHG-5453DP-PLX

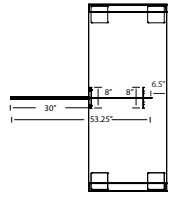

**Features and Specifications:**

- ♥ Freestanding partition panel, includes levelers
- ♥ Soft corner detail on plexiglass
- ♥ Easy to move around & easily removed
- ♥ 3/16" plexiglass & 3/4" laminate construction
- ♥ Laminate base available in all standard Heartwood finishes clear or frosted plexiglass topper
- ♥ Alternate sizing available

**Custom Sizes**

- ♥ Custom available.....call Customer Service. Please specify quote number when ordering. For Simple Width; changes, use the price of the next size up.

**Ordering Example :** To price a custom size panel PHG-4870FDP-PLX **use the pricing for** PHG-4878FDP-PLX

**Shipping**

- ♥ Some items are shipped fully assembled, some are shipped in rta cartoning.
- Look for **RTA** symbol at each model number.

**Warranty**

- ♥ Limited Lifetime

**NOTE:** Information is current at time of print. For up to date information check online at [WWW.HEARTWOOD.CA](http://WWW.HEARTWOOD.CA)

**Finishes**

| Plexiglass Panel |         |
|------------------|---------|
| ABBR             | COLOUR  |
| CL               | Clear   |
| FR               | Frosted |

| ABBR | LAMINATE COLOUR    |
|------|--------------------|
| AM   | Autumn Maple       |
| BL   | Black              |
| BW   | Black Walnut       |
| CD   | Cappuccino Dream** |
| CM   | Charcoal Matrix    |
| DE   | Desert Sand        |
| DD   | Driftwood***       |
| DW   | Driftwood Grey**   |
| EZ   | Evening Zen        |
| GA   | Golden Ash         |
| GD   | Grey Dusk          |
| GM   | Grey Matrix        |
| GR   | Grey               |
| GT   | Graphite           |
| HM   | Hardrock Maple     |
| NC   | Noce Cocoa         |
| PW   | Pure White         |
| RM   | Royal Mahogany     |
| SM   | Sugar Maple        |
| SW   | Seaside White      |
| VA   | Volcanic Ash       |
| WW   | Winter Wood        |

\*\* Textured Finish  
 \*\*\* Non-Textured Finish - 1" & 1 1/2" laminate ONLY

**High Pressure (HP) laminate available Contact Customer Service.**

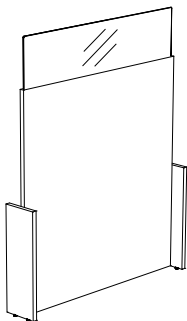
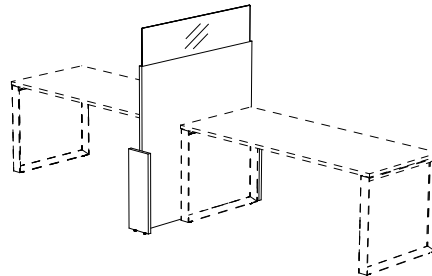

PHG-4860FDP-PLX PHG-4853DP-PLX (SHOWN)

| MODEL | LIST | WEIGHT | CUBE            | W  | D  | H  |
|-------|------|--------|-----------------|----|----|----|
|       |      | LBS    | FT <sup>3</sup> | IN | IN | IN |

**FREESTANDING DIVIDER PANEL WITH PLEXIGLASS TOP**

|                 |         |      |      |   |       |       |
|-----------------|---------|------|------|---|-------|-------|
| PHG-4860FDP-PLX | \$1,132 | 72.8 | 2.76 | 8 | 49.25 | 59.25 |
| PHG-4878FDP-PLX | \$1,232 | 83.8 | 3.09 | 8 | 49.25 | 77    |

**PLEXIGLASS FINISH:** CLEAR (CL) OR FROSTED (FR)

**LAMINATE FINISHES:** ALL STANDARD HEARTWOOD LAMINATE FINISHES

**RTA**

### Features and Specifications:

- ♥ Freestanding partition panel
- ♥ Converts to mobile unit - optional casters (-M)
- ♥ Soft corner detail on plexiglass
- ♥ Easy to move around & easily removed
- ♥  $\frac{3}{16}$ " plexiglass &  $\frac{3}{4}$ " laminate construction
- ♥ Laminate base available in all standard Heartwood finishes with clear or frosted plexiglass topper
- ♥ Alternate sizing available

### Custom Sizes

- ♥ Custom available.....call Customer Service. Please specify quote number when ordering. For Simple Width; changes, use the price of the next size up.

**Ordering Example:** To price a custom size panel PHG-3266SA-PLX-PLX use the pricing for PHG-3666SA-PLX

### Shipping

- ♥ Some items are shipped fully assembled, some are shipped in rta cartoning.

Look for **RTA** symbol at each model number.

### Warranty

- ♥ Limited Lifetime

**NOTE:** Information is current at time of print. For up to date information check online at [WWW.HEARTWOOD.CA](http://WWW.HEARTWOOD.CA)

### Finishes

| Plexiglass Panel |         |
|------------------|---------|
| ABBR             | COLOUR  |
| CL               | Clear   |
| FR               | Frosted |

| ABBR | LAMINATE COLOUR    |
|------|--------------------|
| AM   | Autumn Maple       |
| BL   | Black              |
| BW   | Black Walnut       |
| CD   | Cappuccino Dream** |
| CM   | Charcoal Matrix    |
| DE   | Desert Sand        |
| DD   | Driftwood***       |
| DW   | Driftwood Grey**   |
| EZ   | Evening Zen        |
| GA   | Golden Ash         |
| GD   | Grey Dusk          |
| GM   | Grey Matrix        |
| GR   | Grey               |
| GT   | Graphite           |
| HM   | Hardrock Maple     |
| NC   | Noce Cocoa         |
| PW   | Pure White         |
| RM   | Royal Mahogany     |
| SM   | Sugar Maple        |
| SW   | Seaside White      |
| VA   | Volcanic Ash       |
| WW   | Winter Wood        |

\*\* Textured Finish  
\*\*\* Non-Textured Finish - 1" & 1½" laminate ONLY

**High Pressure (HP) laminate available Contact Customer Service.**

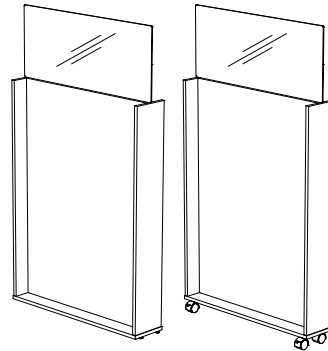

| MODEL | LIST | WEIGHT | CUBE            | W  | D  | H  |
|-------|------|--------|-----------------|----|----|----|
|       |      | LBS    | FT <sup>3</sup> | IN | IN | IN |

#### FREESTANDING MOBILE OR STATIONARY PROTECTIVE HEALTH GUARD PANEL

|                  |         |       |      |       |   |    |
|------------------|---------|-------|------|-------|---|----|
| PHG-3066SA-PLX   | \$1,343 | 66.75 | 1.77 | 29.75 | 8 | 65 |
| PHG-3066SA-PLX-M | \$1,470 | 66.75 | 1.77 | 29.75 | 8 | 65 |
| PHG-3666SA-PLX   | \$1,438 | 66.75 | 2.10 | 35.5  | 8 | 65 |
| PHG-3666SA-PLX-M | \$1,562 | 66.75 | 2.10 | 35.5  | 8 | 65 |

PLEXIGLASS FINISH: CLEAR (CL) OR FROSTED (FR)

FINISHES WITH CLEAR OR FROSTED PLEXIGLASS TOPPER

LAMINATE FINISHES: ALL STANDARD HEARTWOOD LAMINATE FINISHES

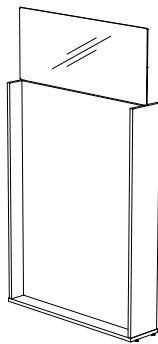

PHG-3666SA-PLX (SHOWN)

**RTA**

# FRAMEWORK

## GLASS PANEL EXTENSIONS OR DESKTOP PANELS

### Features and Specifications:

- ♥ 5mm clear tempered glass panels
- ♥ Suitable for installation on HDL's Framework modular panel system or other third party panel system designs
- ♥ Suitable for desktop mount design installation
- ♥ Maximum height of 22" recommended (For higher heights, see Surface Mounted Health Guards)
- ♥ Alternate sizing available
- ♥ See HDL Framework series for more information on Heartwood's Modular Panel system
- ♥ Uses Outline Plus top mount mounting hardware. Edge mount mounting hardware for desktop applications is also available. See Outlines Plus.

### Custom Sizes

- ♥ Custom available.....call Customer Service. Please specify quote number when ordering.  
For Simple Width; changes, use the price of the next size up.

**Ordering Example :** To price a custom size panel FRM1-2268CLG-SL  
**use the pricing for FRM1-2272CLG-SL**

### Shipping

- ♥ Some items are shipped fully assembled, some are shipped in RTA cartoning.  
Look for RTA symbol **RTA** at each model number.

### Warranty

- ♥ 2 year warranty

NOTE: Information is current at time of print. For up to date information check online at [WWW.HEARTWOOD.CA](http://WWW.HEARTWOOD.CA)

### Finishes

| Bracket Finishes |        |
|------------------|--------|
| ABBR             | COLOUR |
| SL               | Silver |
| BL               | Black  |

| Tempered Glass |        |
|----------------|--------|
| ABBR           | COLOUR |
| CL             | Clear  |

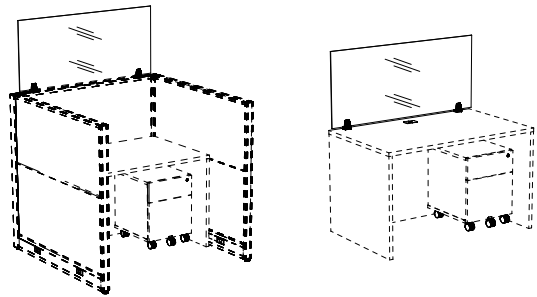

**Caution:** Mounting to panels, installer must ensure panel is stable to avoid tipping.

| MODEL | LIST | WEIGHT | CUBE            | W  | D  | H  |
|-------|------|--------|-----------------|----|----|----|
|       |      | LBS    | FT <sup>3</sup> | IN | IN | IN |

#### TEMPERED GLASS PANEL EXTENSION

TOP MOUNT - MOUNT ON FRAMEWORK PANELS, 3RD PARTY PARTITION PANELS OR DESKTOP

|              |       |      |      |       |      |       |
|--------------|-------|------|------|-------|------|-------|
| FRM1-2224CLG | \$454 | 9.9  | 0.34 | 23.25 | 0.25 | 21.75 |
| FRM1-2230CLG | \$475 | 12.1 | 0.42 | 29.25 | 0.25 | 21.75 |
| FRM1-2236CLG | \$504 | 14.3 | 0.50 | 35    | 0.25 | 21.75 |
| FRM1-2242CLG | \$553 | 16.5 | 0.58 | 41    | 0.25 | 21.75 |
| FRM1-2248CLG | \$600 | 18.7 | 0.66 | 47    | 0.25 | 21.75 |
| FRM1-2260CLG | \$614 | 23.1 | 0.82 | 58.75 | 0.25 | 21.75 |
| FRM1-2266CLG | \$659 | 25.4 | 0.89 | 64.5  | 0.25 | 21.75 |
| FRM1-2272CLG | \$704 | 27.6 | 0.98 | 70.5  | 0.25 | 21.75 |

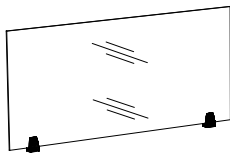

**RTA**

FRM1-2248CLG (SHOWN)

See Outlines *Plus* for other top mount (TM1) or edge mount (EM1) options or **OUT-54** for **Plexiglass Panel Extensions**, designed to work with HDL Framework

- SUITABLE FOR DESKTOP MOUNTING APPLICATIONS
- 5MM CLEAR TEMPERED GLASS, POLISHED EDGES, "TOUCH" CORNERS ARE STANDARD
- OPTIONAL RADIUS CORNERS ADD -R TO SKU, INCLUDES BOTH UPPER CORNERS.  
UPCHARGE OF
- TOP MOUNT BRACKET MOUNTS THROUGH TOP PANEL TRIM OF PANEL INTO SOLID CORE STRUCTURE
- WOOD/METAL SCREWS INCLUDED (NOT SELF TAPPING METAL SCREWS)
- 1/8" PILOT HOLE IS SUGGESTED PRIOR TO INSTALL OF PANEL, DRILL BIT NOT INCLUDED. FULL DETAILS OF ASSEMBLY INSTRUCTIONS INCLUDE MOUNTING DETAILS
- COMPATIBLE WITH 3RD PARTY PANELS AS LONG AS THE PANELS AREN'T HOLLOW AND HAS SOMETHING TO ATTACH TO, WE INCLUDE 1.75" LONG SCREWS IN THE PACKAGE (WE CANNOT WARRANTY PRODUCT IF NOT COMPATIBLE WITH 3RD PARTY PANELS).



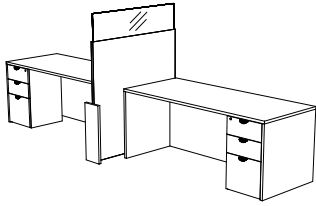

**LAYOUT 1**

|                        |  |    |                |
|------------------------|--|----|----------------|
| <b>388-3066DS</b>      | 66" DESK SHELL                                 | X2 | <b>\$837</b>   |
| <b>388-19FPUFX</b>     | FREESTANDING PEDESTAL - NO TOP                 | X2 | <b>\$871</b>   |
| <b>PHG-4860FDP-PLX</b> | FREESTANDING DIVIDER PANEL WITH PLEXIGLASS TOP |    | <b>\$1,132</b> |
| <b>TOTAL</b>           |  |    | <b>\$4,548</b> |

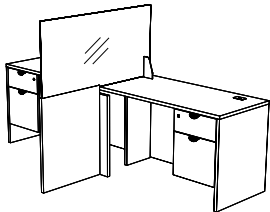
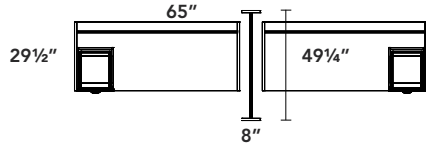

**LAYOUT 2**

|                       |  |    |                |
|-----------------------|--|----|----------------|
| <b>388-2496CT-A-C</b> | 24" CONNECTOR TOP                      |    | <b>\$1,244</b> |
| <b>UPCHRG-CTRGBL</b>  | CENTER SUPPORT GABLE                   |    | <b>\$198</b>   |
| <b>388-HPF</b>        | BOX/FILE HANGING PEDESTAL              | X2 | <b>\$752</b>   |
| <b>PHG-4853DP-PLX</b> | DESK DIVIDER PANEL WITH PLEXIGLASS TOP |    | <b>\$744</b>   |
| <b>TOTAL</b>          |  |    | <b>\$3,690</b> |

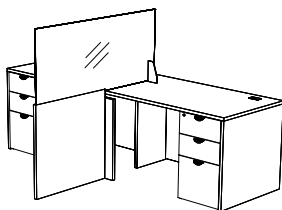
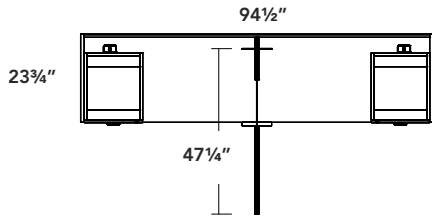

**LAYOUT 3**

|                       |  |    |                |
|-----------------------|--|----|----------------|
| <b>388-3096CT-A-C</b> | 30" CONNECTOR TOP                      |    | <b>\$1,352</b> |
| <b>UPCHRG-CTRGBL</b>  | CENTER SUPPORT GABLE                   |    | <b>\$198</b>   |
| <b>388-19FPUFX</b>    | FREESTANDING PEDESTAL - NO TOP         | X2 | <b>\$871</b>   |
| <b>PHG-5453DP-PLX</b> | DESK DIVIDER PANEL WITH PLEXIGLASS TOP |    | <b>\$863</b>   |
| <b>TOTAL</b>          |  |    | <b>\$4,155</b> |

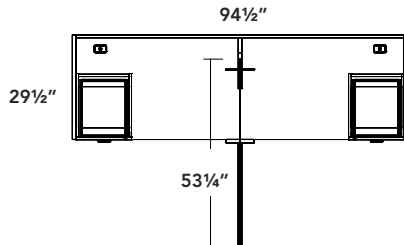



# FRAMEWORK SERIES

This is a metric series (imperial sizing available). Please refer to page [INDEX-1](#) for details

|  |                        |
|--|------------------------|
| <b>Series Specifications &amp; Description</b> ..... | <a href="#">FRM-3</a>  |
| <b>Product by Category</b> .....                     |                        |
| <b>Tops</b> .....                                    |                        |
| Work Surfaces & Connectors .....                     | <a href="#">FRM-7</a>  |
| Extended Corner Modules .....                        | <a href="#">FRM-8</a>  |
| 90° Corner Modules .....                             | <a href="#">FRM-9</a>  |
| 120° Angled Corner .....                             | <a href="#">FRM-9</a>  |
| Peninsula Tops .....                                 | <a href="#">FRM-9</a>  |
| Transaction Tops .....                               | <a href="#">FRM-11</a> |
| <b>Work Surface Supports</b> .....                   |                        |
| Metal Legs & Brackets .....                          | <a href="#">FRM-12</a> |
| Support Gables .....                                 | <a href="#">FRM-12</a> |
| <b>Pedestals</b> .....                               |                        |
| Supporting Gable Pedestals .....                     | <a href="#">FRM-13</a> |
| Mobile Pedestals .....                               | <a href="#">FRM-13</a> |
| <b>Storage</b> .....                                 |                        |
| Overhead Storage .....                               | <a href="#">FRM-14</a> |
| Mid-Height and Tall Storage .....                    | <a href="#">FRM-15</a> |
| <b>Panel Extensions</b> .....                        | <a href="#">FRM-18</a> |
| <b>Accessories</b> .....                             | <a href="#">FRM-19</a> |
| <b>FrameWork Series Layouts</b> .....                | <a href="#">FRM-20</a> |



## FrameWork

### Panel Suspended Series

**Made-to-FIT** suspended furniture series of various Heartwood work surfaces, storage, and accessories is designed to connect and hang from **HDL Framework IN-STOCK** free-standing modular panels (sold separately through HDL- refer HDL pricer FRM tab).

**NOTE:** Information is current at time of print. For up to date information check online at [WWW.HEARTWOOD.CA](http://WWW.HEARTWOOD.CA).

## Features

- ♥ Panel hung work surfaces in various shapes allow full access to HDL Framework panels built-in wire management raceway capabilities.
- ♥ Great price - majority of layouts are priced lower than comparable full unit import product configurations.
- ♥ Panel hung storage and shelving options which are easy to slide, adjust, and secure to your preferred height.
- ♥ Large selection of finish options for laminates, edge banding, handle and fabric options (fabric for mobile pedestals only).
- ♥ Solid colour, woodgrains, and two tone combinations available.
- ♥ Mix-and-match FrameWork components with 388 and WorkScape series storage cabinets and credenzas.
- ♥ Leveling glides on all floor components.
- ♥ Optional accessories are available. Please see page 100-1 of the Accessories Series from complete details.

## Finishes

| Laminates |                    | SUITABLE FOR |        |               | DEFAULT FINISHES             |                        |              |                 |
|-----------|--------------------|--------------|--------|---------------|------------------------------|------------------------|--------------|-----------------|
| ABBR      | LAMINATE COLOUR    | TOPS         | BASE   | MATCHING EDGE | SHADOW STRIP (BLACK DEFAULT) | HANDLES- (BLACK SCOOP) | LOCK (BLACK) | GROMMET (BLACK) |
| AM        | Autumn Maple       | ✓            | ✓      | ✓             | ✓                            | ✓                      | ✓            | ✓               |
| BL        | Black              | X            | ✓      | ✓             | ✓                            | ✓                      | ✓            | ✓               |
| BW        | Black Walnut       | ✓            | ✓      | ✓             | ✓                            | ✓                      | ✓            | ✓               |
| CD        | Cappuccino Dream** | ✓            | ✓      | ✓             | ✓                            | ✓                      | ✓            | ✓               |
| CM        | Charcoal Matrix    | ✓            | ✓      | Black         | ✓                            | ✓                      | ✓            | ✓               |
| DE        | Desert Sand        | ✓            | ✓      | ✓             | Matching                     | ✓                      | ✓            | ✓               |
| DD        | Driftwood***       | ✓            | ✓ (1") | ✓             | Matching                     | ✓                      | ✓            | ✓               |
| DW        | Driftwood Grey**   | X            | ✓ (¾") | ✓             | Matching                     | ✓                      | ✓            | ✓               |
| EZ        | Evening Zen        | ✓            | ✓      | ✓             | Silver                       | Aluminium              | ✓            | ✓               |
| GA        | Golden Ash         | ✓            | ✓      | ✓             | ✓                            | Black Bar              | ✓            | ✓               |
| GT        | Graphite           | X            | ✓      | ✓             | ✓                            | ✓                      | ✓            | ✓               |
| GR        | Grey               | ✓            | ✓      | ✓             | Matching                     | ✓                      | ✓            | ✓               |
| GD        | Grey Dusk          | ✓            | ✓      | ✓             | ✓                            | Aluminium              | ✓            | ✓               |
| GM        | Grey Matrix        | ✓            | ✓      | Grey          | ✓                            | ✓                      | ✓            | ✓               |
| HM        | Hardrock Maple     | ✓            | ✓      | ✓             | ✓                            | ✓                      | ✓            | ✓               |
| NC        | Noce Cocoa         | ✓            | ✓      | ✓             | Matching                     | Aluminium Bar          | Silver       | Grey            |
| PW        | Pure White         | ✓            | ✓      | ✓             | Matching                     | Aluminium              | Silver       | Grey            |
| RM        | Royal Mahogany     | ✓            | ✓      | ✓             | ✓                            | ✓                      | ✓            | ✓               |
| SM        | Sugar Maple        | ✓            | ✓      | ✓             | ✓                            | ✓                      | ✓            | ✓               |
| SW        | Seaside White      | ✓            | ✓      | ✓             | Matching                     | Aluminium              | Silver       | Grey            |
| VA        | Volcanic Ash       | ✓            | ✓      | ✓             | Matching                     | Black Bar              | ✓            | ✓               |
| WW        | Winter Wood        | ✓            | ✓      | ✓             | Matching                     | Aluminium Bar          | Silver       | Grey            |

\*\* Textured Finish

\*\*\* Non-textured Finish 1" & 1½" only

**High Pressure (HP) laminate available. Contact Customer Service**

## Construction

- ♥ Work surfaces and gables are all 1" thermally fused laminate tops on a 45lb industrial particle board core.  
**1 ½" tops are available on request**, contact Customer Service.  
- **Ordering example: (add "2" after FRM) FRM2-3072WS**
- ♥ Transaction tops, overhead storage, overhead shelving (with exception of 42" and 48" wide), pedestal fronts, and side gables are ¾" thermally fused laminate on industrial particle board core.

- **1" and 1½" transaction tops are available on request**, contact Customer Service.
- **Ordering example:** (1" top add "1" after FRM, 1½" top add "2" after FRM) FRM1-1272TA
- 1" overhead shelves are available on request and will incur an additional 5% upcharge.

## Metal Components

- ♥ All brackets and metal gable legs finished in Charcoal powder coat to match HDL FrameWork Charcoal powder coated panel frames.
- ♥ Square metal post support leg (900-SQ3) finished in powder coat Black (BL), Silver (SL) and White (WH).
- ♥ Metal mobile pedestals available in Black (BL), Titanium (TT) or White (WH) finish.

## Fabric

- ♥ HDL FrameWork panels are finished in a 100% polypropylene woven grey fabric. Panels are ordered separately through HDL only.

## Edge Detail

- ♥ Edges:
  - Banding changes to an alternate Heartwood standard colour are available at no extra charge.
  - Framework edges all finished in a matching 2mm edge band.
- ♥ Highlight/shadow strip:
  - Highlight/shadow strip applies to FRM pedestals and 388 storage cabinets.

## Work Surfaces & Connectors

- ♥ All work surfaces are non-handed.
- ♥ Non-standard sizes are available see "Custom Sizes" section.
- ♥ Tops over 72" up to maximum 96" length include center gable.
- ♥ One grommet centered at the back on rectangle tops and angled peninsula for routing power and communication cables.
- ♥ Panel supported hanging clips included. Recommended use is one every 24" and connects the panel to the worksurface.
- ♥ Work surfaces can be supported by pedestal, end gable, metal bracket, metal leg, metal post (900-SQ3) and/or flat brackets (quarter rounds tops include brackets).

## Corner Module Work Surfaces

- ♥ All corner module work surfaces are non-handed.
- ♥ Corners modules (CM and AC120) and extended corner modules (ECM) can hang from the two back edges via panel supported hanging clips.
- ♥ Panel supported hanging clips included. Recommended use is one every 24".
- ♥ Corners are available in 120° angled corner (AC120) or 90° corner module (CM).
  - 90° CM available to connect to 18", 24" or 30" work surface depths.
  - 120° in 24" depth only.
  - One grommet centered at the back corner for routing power and communication cables.
- ♥ Extended corner modules (ECM) available in three styles:
  - ECM - Standard extended corner module
  - SECM - Shaped extended corner module (recommended with cutback connector)
  - RECM - Round/radiused extended corner module
- ♥ ECM's have two grommets for routing power and communication cables.
- ♥ Corner module peninsula top available. Includes 900-SQ3 metal post for support
- ♥ Custom shapes available on request. Contact Customer Service for custom corner options.

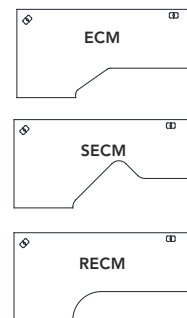

## Transaction Tops

- ♥ Fits onto 48" tall panels only.
- ♥ 12" deep only.
- ♥ Available in 3 styles- rectangular (size to all panel lengths), D top (overhangs), double D top (overhangs).
- ♥ Includes brackets for fitting.

## Overhead Storage

- ♥ Laminate top, gables and bottom with no back.
- ♥ Supported by FRM metal overhead shelf brackets (included).
- ♥ Available in 15" high only with 24", 30" and 36" wide options.
- ♥ Must be installed on a panel of equal width.

- ♥ Available as open storage or with hinged doors
- ♥ Overhead storage doors do not lock, unless requested. There is a **\$76** list upcharge.
- ♥ Overhead storage doors have small scoop handles by default. Handles can be changed at no extra charge. See Accessories page **100-3** for selection details.
- ♥ Maximum weight 100lbs

### Overhead Shelf

- ♥ Supported by FRM metal overhead shelf brackets
- ♥ Available in 24", 30", and 36" (3/4" laminate), plus 42" and 48" wide (1" thick).
- ♥ Must be installed on a panel of equal width.

### Work Surface Supports/Gables/Brackets

- ♥ Non-handed full and half gables- (30" top requires a 16" half gable, 24" top a 13" half gable)
- ♥ Half gables have a half moon wire access at the top.
- ♥ Metal open gable legs available for 24" deep tops only must be specified in either left or right.
- ♥ All brackets included.
- ♥ Each gable comes with two easy to adjust levellers
- ♥ Peninsula, bullet, and half moon tops supported by a black or silver square metal leg 900-SQ3 (included with tops, no additional SKU)
- ♥ 'Low cost option' metal work surface bracket can be used to support a suspended work surface end when end is against a wall, and the supporting panel is securely fastened to a wall with a wall mount bracket (FRM-FWMB-HDL).

### Pedestals

- ♥ Supporting under desk gable pedestals 24" and 30" deep are available in laminate construction.
- ♥ Non-supporting mobile pedestals are available in laminate or metal construction.
- ♥ The below information applies to all laminate pedestals only.
  - Option of under desk Box-Box-File (BBF), File-File (FF) or a mobile Box-File (BF).
  - Fabric cushion available for mobile pedestal only (FRM-MPEDCUSH). Please refer to the Finishes & Fabrics tab on the [www.heartwood.ca](http://www.heartwood.ca) website for a complete listing of the colour choices available.
  - All drawers are 5 pieces - 4 x 1/2" black sides & 1 x 1/8" black bottom.
  - All box and file drawers mounted on FULL extension ball bearing slides, 75lb load rating.
  - Lateral file drawers mounted on FULL extension ball bearing slides, 100lb load rating.
- ♥ One pencil tray included with every box drawer unit.
- ♥ Core Removable Locks are standard on all drawer pedestals, lateral files and storage cabinets.
  - For keyed -alike locks, indicate on your order, which standard units you would like keyed-alike.
  - See "Locks" below for more information on how to order.

### NOTE:

- ♥ All File and Lateral Files drawers are constructed to support hanging file folders. Broken drawer bottoms are not covered by warranty. If you expect to store heavy items, ie phone books, paper etc. on the drawer bottom, we offer an optional 1/2" bottom for these drawers. Please contact Customer Service for pricing.

### Glazed Doors (Excludes HDL Glazed System Panels)

- ♥ All glazed doors and panels consist of an aluminum frame with a 5mm plexiglass panel.
- ♥ The prices shown for aluminum frame glazed doors is an upcharge and must be added to the base price of the unit it goes on.
- ♥ Doors include silver finish, bar handles (except on hutches & overheads which do not need handles).
- ♥ Frames have a natural, brushed aluminum finish.
- ♥ AGD doors are not locking by default, add -L to the SKU and upcharge of **\$76**
- ♥ Plexiglass panels are available in 3 styles:
  1. Clear (CL)
  2. Frosted (FR)
  3. Bronze (BR)
- Please indicate on your purchase order (PO) which plexiglass style you would like.

### Locks:

- ♥ All tall cabinet and storage cabinet laminate doors and drawers lock, **except where noted in price book.**
- ♥ Two lock finishes are available (Silver - SL & Black BL)
- ♥ To add an optional lock to a component or Aluminum Glazed Doors (AGD), add -L to the SKU and upcharge of **\$76**

- ♥ For keyed-alike locks, indicate on your order, which standard units you would like keyed-alike.
    - > Order the appropriate quantity of like numbered cores required at **\$11** each.
- Ordering Example:** If you require 3 units to be keyed-alike, order **100-corepack-3** (\$11 x 3 = \$33).

### Tall and Mid-Height Storage (388/600 and WorkScape SKUs)

- ♥ Please refer to 388 Series, page [388/600-46](#) and Workscape Series, page [WRK-31](#) for series specifications.
- ♥ All tall & mid-height wardrobe storage & storage cabinets can have an optional boot shelf. Upcharges apply when ordering bootshelf: **add -BS** to product SKU.
  - > **Ordering Example:** 388-4724CWR-24-BS

| Bootshelf Upcharges |       |
|---------------------|-------|
| 12" w to 23" w      | \$106 |
| 24" w to 35" w      | \$119 |
| 36" w or >          | \$155 |

### Panel Extensions

- ♥ Can be installed on 48" or 66" high Framework Modular Panels, on third party modular panel designs or used in work surface mount applications.
- ♥ Wood/metal screws included (not self tapping metal screws)
- ♥ 1/8" pilot hole is suggested prior to install of panel, drill bit not included. Full details of assembly instructions include mounting details
- ♥ Compatible with 3rd party panels as long as the panels aren't hollow and has something to attach to, we include 1.75" long screws in the package (we cannot warranty product if not compatible with 3rd party panels).

### Accessories

- ♥ Full range of accessories available. Refer page [FRM-19](#) or go to Accessories Series [100-1](#) for a complete list of keyboard trays, pencil drawers, grommets, task lighting, CPU holders, etc.

### Custom Sizes

- ♥ Custom sizes available
- For simple width or depth changes, use the price of the next model size up shown in the pricer.
- **Ordering Example:** For the price of a FRM-2468WS: use the price of the next larger size- FRM-2472WS.

### NOTE:

- ♥ If door or drawer changes are involved, please contact Customer Service for a quote.
- ♥ Please specify Quote Number when ordering.

### Shipping

- ♥ Some items are shipped fully assembled, some are shipped in Ready-to-Assemble (rta) cartoning.
- ♥ Look for rta symbol **RTA** at each model number.



ALL WORK SURFACES ARE 1" LAMINATE TOPS. 1½" TOPS ARE AVAILABLE ON REQUEST  
ORDERING EXAMPLE (ADD "2" AFTER FRM): FRM2-2424WS.

| MODEL | LIST | WEIGHT | CUBE            | W  | D  | H  |
|-------|------|--------|-----------------|----|----|----|
|       |      | LBS    | FT <sup>3</sup> | IN | IN | IN |

**WORK SURFACE**

NON-HANDED. ONE CENTERED GROMMET. INCLUDES FRM-HC-AL HANGING CLIPS.  
24" DEEP

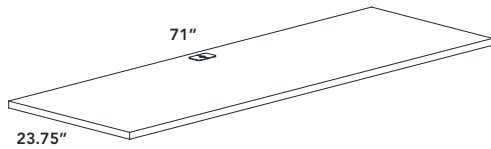

FRM-2472WS

|            |       |    |     |       |       |   |
|------------|-------|----|-----|-------|-------|---|
| FRM-2424WS | \$196 | 17 | 0.5 | 23.75 | 23.75 | 1 |
| FRM-2430WS | \$196 | 21 | 0.6 | 29.75 | 23.75 | 1 |
| FRM-2436WS | \$212 | 25 | 0.7 | 35.5  | 23.75 | 1 |
| FRM-2442WS | \$228 | 29 | 0.8 | 41.5  | 23.75 | 1 |
| FRM-2448WS | \$244 | 34 | 1   | 47.25 | 23.75 | 1 |
| FRM-2454WS | \$275 | 38 | 1.1 | 53.25 | 23.75 | 1 |
| FRM-2460WS | \$352 | 43 | 1.2 | 59.25 | 23.75 | 1 |
| FRM-2466WS | \$383 | 48 | 1.3 | 65    | 23.75 | 1 |
| FRM-2472WS | \$408 | 52 | 1.4 | 71    | 23.75 | 1 |

30" DEEP

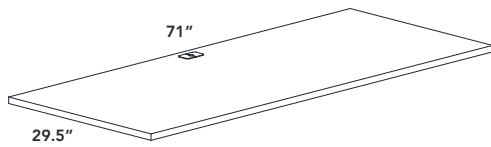

FRM-3072WS

|            |       |    |     |       |      |   |
|------------|-------|----|-----|-------|------|---|
| FRM-3024WS | \$244 | 21 | 0.6 | 23.75 | 29.5 | 1 |
| FRM-3030WS | \$244 | 27 | 0.8 | 29.5  | 29.5 | 1 |
| FRM-3036WS | \$250 | 32 | 0.9 | 35.5  | 29.5 | 1 |
| FRM-3042WS | \$275 | 37 | 1   | 41.5  | 29.5 | 1 |
| FRM-3048WS | \$298 | 43 | 1.2 | 47.25 | 29.5 | 1 |
| FRM-3054WS | \$352 | 48 | 1.3 | 53.25 | 29.5 | 1 |
| FRM-3060WS | \$400 | 54 | 1.5 | 59.25 | 29.5 | 1 |
| FRM-3066WS | \$431 | 59 | 1.6 | 65    | 29.5 | 1 |
| FRM-3072WS | \$456 | 65 | 1.8 | 71    | 29.5 | 1 |

• TOPS AVAILABLE UP TO 96". CONTACT CUSTOMER SERVICE FOR PRICING.

RTA

**CUTBACK CONNECTOR**

NON-HANDED. ONE CENTERED GROMMET. INCLUDES FRM-HC-AL HANGING CLIPS.  
24" DEEP

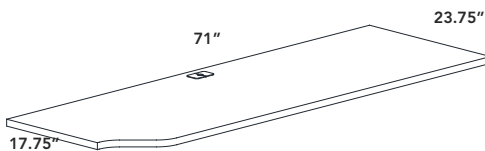

FRM-241872CC

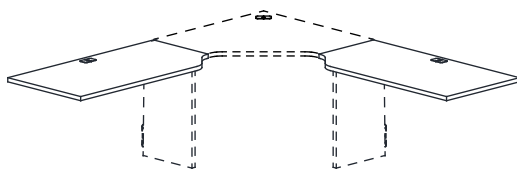

Example:  
FRM-241848CC (X2) W/ FRM-1836CM

|              |       |    |     |       |              |   |
|--------------|-------|----|-----|-------|--------------|---|
| FRM-241824CC | \$190 | 17 | 0.5 | 23.75 | 17.75/ 23.75 | 1 |
| FRM-241830CC | \$226 | 18 | 0.6 | 29.75 | 17.75/ 23.75 | 1 |
| FRM-241836CC | \$237 | 22 | 0.7 | 35.5  | 17.75/ 23.75 | 1 |
| FRM-241842CC | \$268 | 26 | 0.8 | 41.5  | 17.75/ 23.75 | 1 |
| FRM-241848CC | \$315 | 30 | 1   | 47.25 | 17.75/ 23.75 | 1 |
| FRM-241854CC | \$330 | 34 | 1.1 | 53.25 | 17.75/ 23.75 | 1 |
| FRM-241860CC | \$367 | 38 | 1.2 | 59.25 | 17.75/ 23.75 | 1 |
| FRM-241866CC | \$396 | 42 | 1.3 | 65    | 17.75/ 23.75 | 1 |
| FRM-241872CC | \$418 | 46 | 1.4 | 71    | 17.75/ 23.75 | 1 |

• TOPS AVAILABLE UP TO 96". CONTACT CUSTOMER SERVICE FOR PRICING.

RTA

ALL WORK SURFACES ARE 1" LAMINATE TOPS. 1½" TOPS ARE AVAILABLE ON REQUEST  
**ORDERING EXAMPLE (ADD "2" AFTER FRM): FRM2-2424WS.**

| MODEL | LIST | WEIGHT | CUBE            | W  | D  | H  |
|-------|------|--------|-----------------|----|----|----|
|       |      | LBS    | FT <sup>3</sup> | IN | IN | IN |

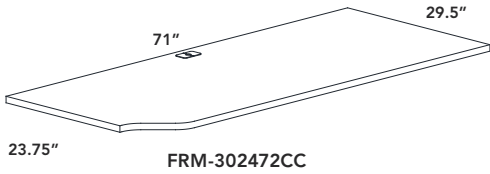

FRM-302472CC

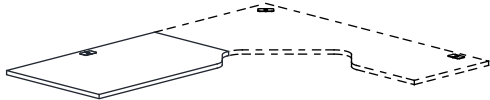

Example:  
**FRM-302448CC W/ FRM-362472SECM**

**RTA**

**CUTBACK CONNECTOR**

NON-HANDED. ONE CENTERED GROMMET. INCLUDES FRM-HC-AL HANGING CLIPS.  
 30" DEEP

|              |       |    |     |       |             |   |
|--------------|-------|----|-----|-------|-------------|---|
| FRM-302424CC | \$207 | 18 | 0.6 | 23.75 | 23.75/ 29.5 | 1 |
| FRM-302430CC | \$207 | 23 | 0.8 | 29.75 | 23.75/ 29.5 | 1 |
| FRM-302436CC | \$236 | 28 | 0.9 | 35.5  | 23.75/ 29.5 | 1 |
| FRM-302442CC | \$318 | 33 | 1   | 41.5  | 23.75/ 29.5 | 1 |
| FRM-302448CC | \$332 | 38 | 1.2 | 47.25 | 23.75/ 29.5 | 1 |
| FRM-302454CC | \$354 | 43 | 1.3 | 53.25 | 23.75/ 29.5 | 1 |
| FRM-302460CC | \$378 | 48 | 1.5 | 59.25 | 23.75/ 29.5 | 1 |
| FRM-302466CC | \$395 | 53 | 1.6 | 65    | 23.75/ 29.5 | 1 |
| FRM-302472CC | \$422 | 58 | 1.8 | 71    | 23.75/ 29.5 | 1 |

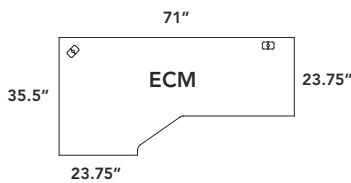
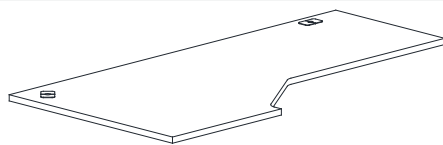

FRM-362472ECM

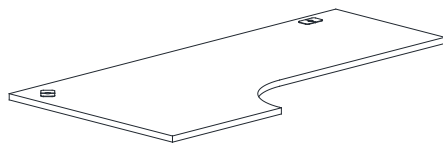

FRM-362472RECM



FRM-362472SECM

**RTA**

**EXTENDED CORNER MODULE**

NON-HANDED. TWO GROMMETS. INCLUDES FRM-HC-AL HANGING CLIPS.  
 THREE STYLES AVAILABLE- SEE BELOW  
 24" DEEP ENDS

|               |          |    |     |            |       |   |
|---------------|----------|----|-----|------------|-------|---|
| FRM-362460ECM | \$545    | 52 | 1.8 | 35.5/59.25 | 23.75 | 1 |
| FRM-362466ECM | \$608    | 55 | 1.9 | 35.5/65    | 23.75 | 1 |
| FRM-362472ECM | \$692    | 60 | 2.1 | 35.5/71    | 23.75 | 1 |
| FRM-362478ECM | *\$994   | 65 | 2.3 | 35.5/77    | 23.75 | 1 |
| FRM-362484ECM | *\$1,025 | 69 | 2.5 | 35.5/82.75 | 23.75 | 1 |
| FRM-422460ECM | \$640    | 54 | 2   | 41.5/59.25 | 23.75 | 1 |
| FRM-422466ECM | \$704    | 60 | 2.2 | 41.5/65    | 23.75 | 1 |
| FRM-422472ECM | \$740    | 65 | 2.5 | 41.5/71    | 23.75 | 1 |
| FRM-422478ECM | *\$1,093 | 71 | 2.7 | 41.5/77    | 23.75 | 1 |
| FRM-422484ECM | *\$1,156 | 73 | 2.9 | 41.5/82.75 | 23.75 | 1 |

30" DEEP ENDS

|               |          |    |     |            |      |   |
|---------------|----------|----|-----|------------|------|---|
| FRM-423060ECM | \$705    | 64 | 2   | 41.5/59.25 | 29.5 | 1 |
| FRM-423066ECM | \$707    | 95 | 2.3 | 41.5/65    | 29.5 | 1 |
| FRM-423072ECM | \$771    | 75 | 2.5 | 41.5/71    | 29.5 | 1 |
| FRM-423078ECM | *\$1,125 | 79 | 2.6 | 41.5/77    | 29.5 | 1 |
| FRM-423084ECM | *\$1,170 | 84 | 2.9 | 41.5/82.75 | 29.5 | 1 |

- \* WORKSURFACES OVER 72" INCLUDE A CENTER GABLE. IF THE WORKSURFACE IS SUPPORTED BY A PEDESTAL OR STORAGE, REDUCE LIST WORKSURFACE LIST PRICE BY \$198 AND INDICATE ON PURCHASE ORDER THAT GABLE IS NOT REQUIRED.
- THREE STANDARD STYLES AVAILABLE:
- EXTENDED CORNER MODULES CAN ALSO BE ORDERED AS:
  - SECM- SHAPED EXTENDED CORNER MODULE OR
  - RECM- RADIUSSED EXTENDED CORNER MODULE
 TO ORDER- CHANGE SUFFIX ACCORDINGLY  
 - EXAMPLE: FRM-362460SECM
- FOR CUSTOM SHAPES CONTACT CUSTOMER SERVICE

ALL WORK SURFACES ARE 1" LAMINATE TOPS. 1 1/2" TOPS ARE AVAILABLE ON REQUEST  
ORDERING EXAMPLE (ADD "2" AFTER FRM): FRM2-2424WS.

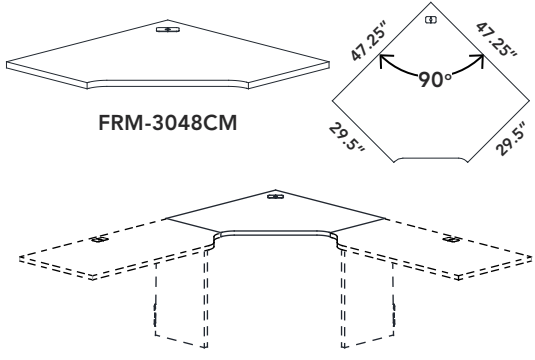
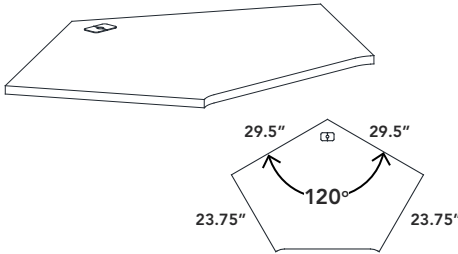
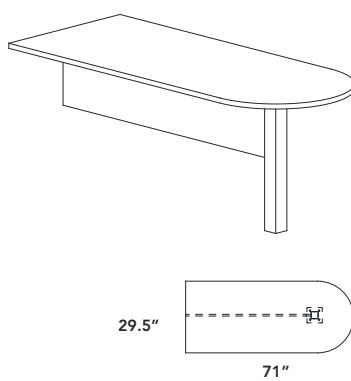
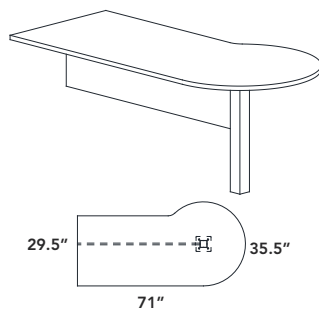
|   | MODEL  | LIST  | WEIGHT | CUBE            | W           | D          | H  |
|---|--|-------|--------|-----------------|-------------|------------|----|
|   |  |       | LBS    | FT <sup>3</sup> | IN          | IN         | IN |
|  <p>FRM-3048CM</p> <p>Example:<br/>FRM-1836CM W/ FRM-241848CC (X2)</p> <p><b>RTA</b></p> | <b>90° CORNER MODULE</b>   |       |        |                 |             |            |    |
|   | NON-HANDED. ONE CENTERED GROMMET. INCLUDES FRM-HC-AL HANGING CLIPS.  |       |        |                 |             |            |    |
|   | 18" DEEP   |       |        |                 |             |            |    |
|   | FRM-1836CM   | \$393 | 23     | 1.1             | 35.5/35.5   | 17.75      | 1  |
|   | 24" DEEP   |       |        |                 |             |            |    |
|   | FRM-2436CM   | \$413 | 29     | 1.1             | 35.5/35.5   | 23.75      | 1  |
|   | FRM-2442CM   | \$461 | 46     | 1.7             | 41.5/41.5   | 23.75      | 1  |
|   | 30" DEEP   |       |        |                 |             |            |    |
|   | FRM-3042CM   | \$501 | 52     | 1.4             | 41.5/41.5   | 29.5       | 1  |
|   | FRM-3048CM   | \$575 | 54     | 1.9             | 47.25/47.25 | 29.5       | 1  |
|  <p><b>RTA</b></p>  | <b>120° ANGLED CORNER</b>  |       |        |                 |             |            |    |
|   | NON-HANDED. ONE CENTERED GROMMET. INCLUDES FRM-HC-AL HANGING CLIPS.  |       |        |                 |             |            |    |
|   | FRM-2430AC120  | \$446 | 26     | 1.5             | 29.5/29.5   | 23.75      | 1  |
|  <p><b>RTA</b></p>   | <b>BULLET TOP</b>  |       |        |                 |             |            |    |
|   | NON HANDED. INCLUDES 1/2 HEIGHT HANGING MODESTY PANEL, BLACK POWDER COATED POST (900-SQ3), AND FRM-HC-AL HANGING CLIPS. IF A SILVER(SL) OR WHITE (WH) POST IS PREFERRED, INDICATE ON PURCHASE ORDER. |       |        |                 |             |            |    |
|   | 24" DEEP   |       |        |                 |             |            |    |
|   | FRM-2448BTM-2  | \$432 | 39     | 1.5             | 47.25       | 23.75      | 29 |
|   | FRM-2460BTM-2  | \$461 | 48     | 1.8             | 59.25       | 23.75      | 29 |
|   | 30" DEEP   |       |        |                 |             |            |    |
|   | FRM-3060BTM-2  | \$491 | 57     | 2.3             | 59.25       | 29.5       | 29 |
| FRM-3072BTM-2   | \$569  | 68    | 2.7    | 71              | 29.5        | 29         |    |
| • TO ORDER 3/4 HEIGHT MODESTY PANEL, CHANGE FROM '-2' TO '-3'   |  |       |        |                 |             |            |    |
|  <p><b>RTA</b></p>   | <b>PENINSULA TOP</b>   |       |        |                 |             |            |    |
|   | NON HANDED. INCLUDES 1/2 HEIGHT HANGING MODESTY PANEL, BLACK POWDER COATED POST (900-SQ3), AND FRM-HC-AL HANGING CLIPS. IF A SILVER(SL) OR WHITE (WH) POST IS PREFERRED, INDICATE ON PURCHASE ORDER. |       |        |                 |             |            |    |
|   | 24" DEEP   |       |        |                 |             |            |    |
|   | FRM-2460PTM-2  | \$560 | 64     | 2.3             | 59.25       | 23.75/29.5 | 29 |
|   | 30" DEEP   |       |        |                 |             |            |    |
|   | FRM-3072PTM-2  | \$697 | 88     | 3.2             | 71          | 29.5/35.5  | 29 |
|   | • TO ORDER 3/4 HEIGHT MODESTY PANEL, CHANGE FROM '-2' TO '-3'  |       |        |                 |             |            |    |

ALL WORK SURFACES ARE 1" LAMINATE TOPS. 1½" TOPS ARE AVAILABLE ON REQUEST  
**ORDERING EXAMPLE (ADD "2" AFTER FRM): FRM2-2424WS.**

| MODEL | LIST | WEIGHT | CUBE            | W  | D  | H  |
|-------|------|--------|-----------------|----|----|----|
|       |      | LBS    | FT <sup>3</sup> | IN | IN | IN |

**CORNER MODULE PENINSULA TOP**

NON HANDED. INCLUDES 1/2 HEIGHT HANGING MODESTY PANEL, BLACK POWDER COATED POST (900-SQ3), AND FRM-HC-AL HANGING CLIPS. IF A SILVER(SL) OR WHITE (WH) POST IS PREFERRED, INDICATE ON PURCHASE ORDER.

24" DEEP

|                   |         |     |     |          |            |    |
|-------------------|---------|-----|-----|----------|------------|----|
| FRM-422472CMPTM-2 | \$1,111 | 112 | 2.8 | 23.75/71 | 47.25/35.5 | 29 |
|-------------------|---------|-----|-----|----------|------------|----|

30" DEEP

|                   |         |     |     |         |            |    |
|-------------------|---------|-----|-----|---------|------------|----|
| FRM-423072CMPTM-2 | \$1,173 | 121 | 2.8 | 29.5/71 | 47.25/35.5 | 29 |
|-------------------|---------|-----|-----|---------|------------|----|

- TO ORDER 3/4 HEIGHT MODESTY PANEL, CHANGE FROM '-2' TO '-3'

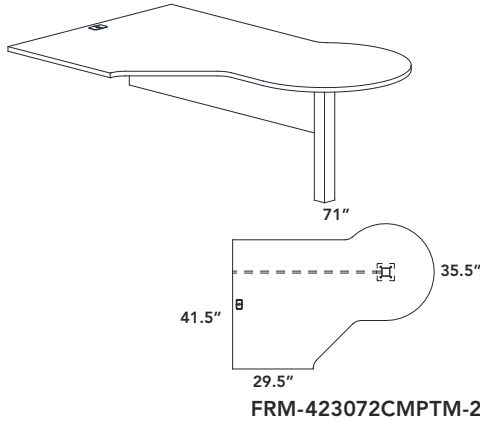

RTA

**ANGLED PENINSULA TOP**

NON HANDED. ONE GROMMET. INCLUDES 1/2 HEIGHT HANGING MODESTY PANEL, BLACK POWDER COATED POST (900-SQ3), AND FRM-HC-AL HANGING CLIPS. IF A SILVER(SL) OR WHITE (WH) POST IS PREFERRED, INDICATE ON PURCHASE ORDER.

24" DEEP

|               |       |    |     |      |       |    |
|---------------|-------|----|-----|------|-------|----|
| FRM-2436APM-2 | \$671 | 52 | 2.4 | 35.5 | 23.75 | 29 |
|---------------|-------|----|-----|------|-------|----|

|               |       |    |     |       |       |    |
|---------------|-------|----|-----|-------|-------|----|
| FRM-2442APM-2 | \$746 | 64 | 2.6 | 41.75 | 23.75 | 29 |
|---------------|-------|----|-----|-------|-------|----|

|               |       |    |     |       |       |    |
|---------------|-------|----|-----|-------|-------|----|
| FRM-2448APM-2 | \$807 | 75 | 2.9 | 47.25 | 23.75 | 29 |
|---------------|-------|----|-----|-------|-------|----|

30" DEEP

|               |       |    |     |      |      |    |
|---------------|-------|----|-----|------|------|----|
| FRM-3036APM-2 | \$691 | 59 | 2.5 | 35.5 | 29.5 | 29 |
|---------------|-------|----|-----|------|------|----|

|               |       |    |     |       |      |    |
|---------------|-------|----|-----|-------|------|----|
| FRM-3042APM-2 | \$761 | 68 | 2.8 | 41.75 | 29.5 | 29 |
|---------------|-------|----|-----|-------|------|----|

|               |       |    |   |       |      |    |
|---------------|-------|----|---|-------|------|----|
| FRM-3048APM-2 | \$841 | 82 | 3 | 47.25 | 29.5 | 29 |
|---------------|-------|----|---|-------|------|----|

- TO ORDER 3/4 HEIGHT MODESTY PANEL, CHANGE FROM '-2' TO '-3'

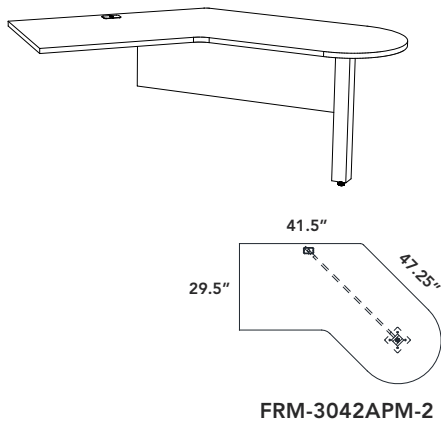

RTA

**QUARTER ROUND TOP**

NON-HANDED. INCLUDES FRM-HC-AL HANGING CLIPS.

|            |       |    |     |       |       |   |
|------------|-------|----|-----|-------|-------|---|
| FRM-2424QR | \$199 | 16 | 0.5 | 23.75 | 23.75 | 1 |
|------------|-------|----|-----|-------|-------|---|

|            |       |    |     |      |      |   |
|------------|-------|----|-----|------|------|---|
| FRM-3030QR | \$323 | 24 | 0.8 | 29.5 | 29.5 | 1 |
|------------|-------|----|-----|------|------|---|

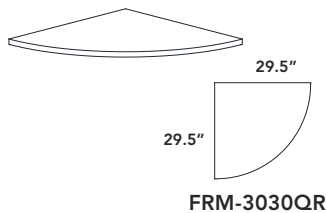

RTA

**HALF MOON TOP**

NON-HANDED. INCLUDES BLACK POWDER COATED POST (900-SQ3), AND FRM-HC-AL HANGING CLIPS. IF A SILVER(SL) OR WHITE (WH) POST IS PREFERRED, INDICATE ON PURCHASE ORDER.

|            |       |    |     |       |       |    |
|------------|-------|----|-----|-------|-------|----|
| FRM-2424HM | \$445 | 33 | 1.1 | 49.75 | 25.25 | 29 |
|------------|-------|----|-----|-------|-------|----|

|            |       |    |     |      |       |    |
|------------|-------|----|-----|------|-------|----|
| FRM-3030HM | \$580 | 41 | 1.6 | 61.5 | 31.25 | 29 |
|------------|-------|----|-----|------|-------|----|

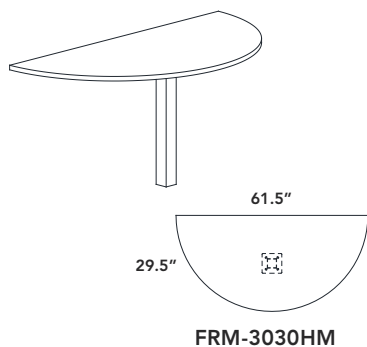

RTA

TRANSACTION TOPS ARE 3/4" LAMINATE TOPS. 1" AND 1 1/2" TOPS ARE AVAILABLE ON REQUEST  
ORDERING EXAMPLE (DROP "3" AFTER FRM FOR 1"): FRM-1272TA.  
ORDERING EXAMPLE (CHANGE TO "2" AFTER FRM FOR 1 1/2"): FRM2-1272TA.

| MODEL | LIST | WEIGHT | CUBE            | W  | D  | H  |
|-------|------|--------|-----------------|----|----|----|
|       |      | LBS    | FT <sup>3</sup> | IN | IN | IN |

**TRANSACTION TOP**

12" WIDE IN 3/4" LAMINATE. CENTERED POSITION ON THE TOP OF THE PANEL.  
INCLUDES BRACKETS.

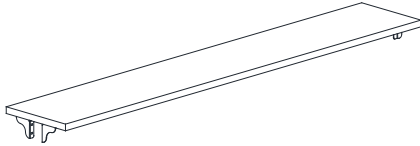

**RTA**

|             |       |    |     |       |    |     |
|-------------|-------|----|-----|-------|----|-----|
| FRM3-1224TA | \$120 | 9  | 0.3 | 23.75 | 12 | .75 |
| FRM3-1230TA | \$139 | 12 | 0.3 | 29.75 | 12 | .75 |
| FRM3-1236TA | \$147 | 14 | 0.5 | 35.5  | 12 | .75 |
| FRM3-1242TA | \$163 | 17 | 0.5 | 41.5  | 12 | .75 |
| FRM3-1248TA | \$180 | 19 | 0.5 | 47.25 | 12 | .75 |
| FRM3-1260TA | \$225 | 24 | 0.6 | 59.25 | 12 | .75 |
| FRM3-1266TA | \$244 | 27 | 0.7 | 65    | 12 | .75 |
| FRM3-1272TA | \$267 | 29 | 0.8 | 71    | 12 | .75 |

**D TRANSACTION TOP**

12" WIDE IN 3/4" LAMINATE. CENTERED POSITION ON THE TOP OF THE PANEL.  
INCLUDES BRACKETS.

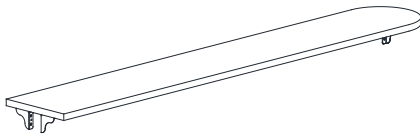

**RTA**

|              |       |    |     |       |    |     |
|--------------|-------|----|-----|-------|----|-----|
| FRM3-1224DTA | \$139 | 15 | 0.3 | 29.75 | 12 | .75 |
| FRM3-1230DTA | \$154 | 17 | 0.4 | 35.5  | 12 | .75 |
| FRM3-1236DTA | \$169 | 19 | 0.4 | 41.5  | 12 | .75 |
| FRM3-1242DTA | \$191 | 22 | 0.5 | 47.25 | 12 | .75 |
| FRM3-1248DTA | \$205 | 25 | 0.6 | 53.25 | 12 | .75 |
| FRM3-1260DTA | \$226 | 27 | 0.7 | 65    | 12 | .75 |
| FRM3-1266DTA | \$253 | 30 | 0.7 | 71    | 12 | .75 |
| FRM3-1272DTA | \$279 | 35 | 0.8 | 77    | 12 | .75 |

**D-D TRANSACTION TOP**

12" WIDE IN 3/4" LAMINATE. CENTERED POSITION ON THE TOP OF THE PANEL.  
INCLUDES BRACKETS.

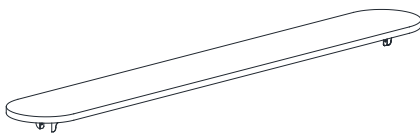

**RTA**

|               |       |    |     |       |    |     |
|---------------|-------|----|-----|-------|----|-----|
| FRM3-1224DDTA | \$169 | 15 | 0.4 | 35.5  | 12 | .75 |
| FRM3-1230DDTA | \$173 | 17 | 0.4 | 41.5  | 12 | .75 |
| FRM3-1236DDTA | \$187 | 19 | 0.5 | 47.25 | 12 | .75 |
| FRM3-1242DDTA | \$213 | 22 | 0.6 | 53.25 | 12 | .75 |
| FRM3-1248DDTA | \$237 | 25 | 0.6 | 59.25 | 12 | .75 |
| FRM3-1260DDTA | \$265 | 27 | 0.7 | 71    | 12 | .75 |
| FRM3-1266DDTA | \$292 | 30 | 0.8 | 77    | 12 | .75 |
| FRM3-1272DDTA | \$315 | 35 | 0.9 | 82.75 | 12 | .75 |

# FRAMEWORK WORK SURFACE SUPPORTS

## METAL LEGS & BRACKETS



| MODEL | LIST | WEIGHT | CUBE            | W  | D  | H  |
|-------|------|--------|-----------------|----|----|----|
|       |      | LBS    | FT <sup>3</sup> | IN | IN | IN |

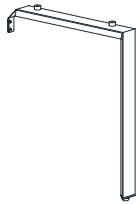

### METAL LEG

FITS 24" OR 30" DEEP TOPS. ORDER LEFT (-L) OR RIGHT (-R). USED TO SUPPORT SUSPENDED WORKSURFACE. MUST BE CONNECTED TO THE END OF A PANEL.

|            |       |   |     |      |       |    |
|------------|-------|---|-----|------|-------|----|
| FRM-ML24-L | \$215 | 9 | 1.6 | 3.25 | 23.75 | 28 |
| FRM-ML24-R | \$215 | 9 | 1.6 | 3.25 | 23.75 | 28 |

- COLOUR MATCHES HDL CHARCOAL POWDER COATED PANEL POSTS.

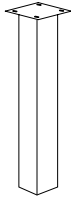

### 3" SQUARE LEG

1 PER CARTON. INCLUDES LEVELER. OPTIONAL CASTER NOT AVAILABLE.

|         |       |     |     |   |   |    |
|---------|-------|-----|-----|---|---|----|
| 900-SQ3 | \$151 | 9.5 | 0.9 | 3 | 3 | 28 |
|---------|-------|-----|-----|---|---|----|

AVAILABLE FINISH: BLACK (BL), SILVER (SL) & WHITE (WH)

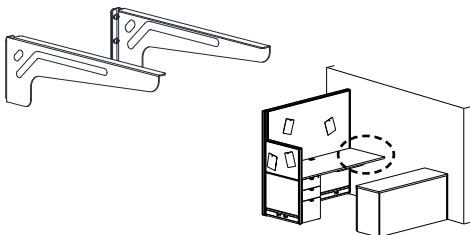

### WORK SURFACE BRACKETS

ORDER LEFT (-L) OR RIGHT (-R). USED TO SUPPORT A SUSPENDED WORK SURFACE END WHEN END IS AGAINST A WALL, AND THE SUPPORTING PANEL IS SECURELY FASTENED TO A WALL W/ A WALL MOUNT BRACKET.

|            |      |   |     |      |       |      |
|------------|------|---|-----|------|-------|------|
| FRM-WB15-L | \$50 | 1 | 0.1 | 1.25 | 15.25 | 4.75 |
| FRM-WB15-R | \$50 | 1 | 0.1 | 1.25 | 15.25 | 4.75 |

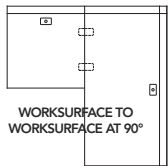

WORKSURFACE TO  
WORKSURFACE AT 90°



### WORK SURFACE FLUSH BRACKET KIT

CONNECTS WORK SURFACE AT 90° TO SAME LEVEL TOPS. INCLUDES TWO BRACKETS W/ SCREWS.

|          |      |     |       |  |  |  |
|----------|------|-----|-------|--|--|--|
| FRM-WFBK | \$38 | 0.5 | 0.005 |  |  |  |
|----------|------|-----|-------|--|--|--|

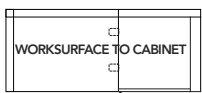

WORKSURFACE TO CABINET

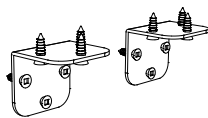

### WORK SURFACE ANGLE BRACKET KIT

CONNECTS WORK SURFACE TO SIDE OF TALL STORAGE CABINET. INCLUDES 2 BRACKETS W/ SCREWS.

|          |      |     |       |  |  |  |
|----------|------|-----|-------|--|--|--|
| FRM-WABK | \$42 | 0.5 | 0.005 |  |  |  |
|----------|------|-----|-------|--|--|--|

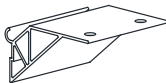

### HANGER CLIP - ONE CLIP PER UNIT.

ALL TOPS INCLUDE THIS NECESSARY HARDWARE. ONLY ORDER THIS SKU IF EXTRA SUPPORT IS REQUIRED

|        |      |     |       |   |   |      |
|--------|------|-----|-------|---|---|------|
| FRM-HC | \$18 | 0.5 | 0.005 | 2 | 2 | 1.25 |
|--------|------|-----|-------|---|---|------|

## SUPPORT GABLES

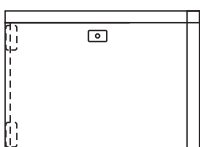

FRM-GF30

### FULL GABLE

USED TO SUPPORT SUSPENDED WORK SURFACE. MUST BE CONNECTED TO THE END OF A PANEL. COMES W/ GABLE & FLAT BRACKETS THAT CAN BE ASSEMBLED LEFT OR RIGHT.

TO FIT 24" DEEP WORK SURFACE

|          |       |    |     |   |       |    |
|----------|-------|----|-----|---|-------|----|
| FRM-GF24 | \$266 | 20 | 0.7 | 1 | 23.75 | 28 |
|----------|-------|----|-----|---|-------|----|

TO FIT 30" DEEP WORK SURFACE

|          |       |    |     |   |      |    |
|----------|-------|----|-----|---|------|----|
| FRM-GF30 | \$285 | 26 | 0.9 | 1 | 29.5 | 28 |
|----------|-------|----|-----|---|------|----|

| MODEL  | LIST         | WEIGHT | CUBE            | W  | D     | H  |
|--|--------------|--------|-----------------|----|-------|----|
|  |              | LBS    | FT <sup>3</sup> | IN | IN    | IN |
| <b>HALF GABLE</b>  |              |        |                 |    |       |    |
| USED TO SUPPORT CONNECTING SUSPENDED WORK SURFACES. QUARTER MOON CUT-OUT AT THE TOP FOR WIRE ACCESS. COMES W/ GABLE & FLAT BRACKETS THAT CAN BE ASSEMBLED LEFT OR RIGHT. |              |        |                 |    |       |    |
| TO FIT 24" DEEP WORK SURFACE   |              |        |                 |    |       |    |
| <b>FRM-GH24</b>  | <b>\$257</b> | 9      | 0.4             | 1  | 13    | 28 |
| TO FIT 30" DEEP WORK SURFACE   |              |        |                 |    |       |    |
| <b>FRM-GH30</b>  | <b>\$257</b> | 15     | 0.5             | 1  | 15.75 | 28 |

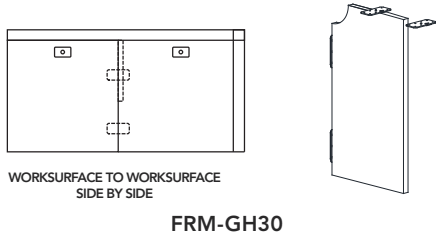

**FRAMEWORK PEDESTALS**  
**SUPPORTING GABLE PEDESTALS**

|   |              |    |     |       |       |    |
|---|--------------|----|-----|-------|-------|----|
| <b>FREESTANDING BOX/BOX/FILE PEDESTAL</b>   |              |    |     |       |       |    |
| COMES W/ BRACKETS THAT CAN BE INSTALLED LEFT OR RIGHT. ALL DRAWERS LOCK.  |              |    |     |       |       |    |
| TO FIT 24" DEEP WORK SURFACE  |              |    |     |       |       |    |
| <b>FRM-1624FPUFX</b>  | <b>\$899</b> | 78 | 6.8 | 15.75 | 23.75 | 28 |
| TO FIT 30" DEEP WORK SURFACE  |              |    |     |       |       |    |
| <b>FRM-1630FPUFX</b>  | <b>\$944</b> | 85 | 8.4 | 15.75 | 29.5  | 28 |
| <ul style="list-style-type: none"> <li>• DEFAULT SMALL SCOOP HANDLES. FOR HANDLE OPTIONS REFER TO ACCESSORIES PAGE <a href="#">100-3</a></li> <li>• CHOICE OF HANDLE AT NO ADDITIONAL CHARGE</li> </ul> |              |    |     |       |       |    |

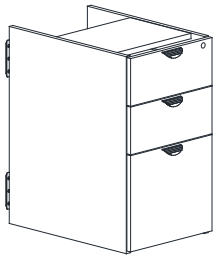

|   |              |    |     |       |       |    |
|---|--------------|----|-----|-------|-------|----|
| <b>FREESTANDING FILE/FILE PEDESTAL</b>  |              |    |     |       |       |    |
| COMES W/ BRACKETS THAT CAN BE INSTALLED LEFT OR RIGHT. ALL DRAWERS LOCK.  |              |    |     |       |       |    |
| TO FIT 24" DEEP WORK SURFACE  |              |    |     |       |       |    |
| <b>FRM-1624FPFFX</b>  | <b>\$899</b> | 78 | 6.8 | 15.75 | 23.75 | 28 |
| TO FIT 30" DEEP WORK SURFACE  |              |    |     |       |       |    |
| <b>FRM-1630FPFFX</b>  | <b>\$944</b> | 85 | 8.4 | 15.75 | 29.5  | 28 |
| <ul style="list-style-type: none"> <li>• DEFAULT SMALL SCOOP HANDLES. FOR HANDLE OPTIONS REFER TO ACCESSORIES PAGE <a href="#">100-3</a></li> <li>• CHOICE OF HANDLE AT NO ADDITIONAL CHARGE</li> </ul> |              |    |     |       |       |    |

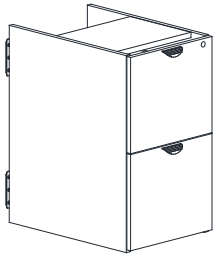

**METAL MOBILE PEDESTALS**

|  |              |      |      |      |      |      |
|--|--------------|------|------|------|------|------|
| <b>METAL MOBILE PEDESTAL - FULL CARTON</b>   |              |      |      |      |      |      |
| BOX / BOX / FILE PEDESTAL. ALL DRAWERS LOCK. LOCKING CASTERS.  |              |      |      |      |      |      |
| <b>100-MMPUF</b>   | <b>\$540</b> | 55   | 7    | 15.5 | 22.5 | 25.2 |
| <b>AVAILABLE FINISHES:</b> BLACK (BL), TITANIUM (TT) & WHITE (WH)  |              |      |      |      |      |      |
| FILE / FILE PEDESTAL. ALL DRAWERS LOCK. LOCKING CASTERS.   |              |      |      |      |      |      |
| <b>100-MMPFF</b>   | <b>\$540</b> | 55   | 7    | 15.5 | 22.5 | 27.1 |
| <b>AVAILABLE FINISHES:</b> BLACK (BL), TITANIUM (TT) & WHITE (WH)  |              |      |      |      |      |      |
| METAL PEDESTALS CAN BE KEYED ALIKEBOX / FILE PEDESTAL. ALL DRAWERS LOCK. LOCKING CASTERS.  |              |      |      |      |      |      |
| <b>100-MMPF</b>  | <b>\$499</b> | 39.7 | 4.62 | 15.5 | 22.5 | 20.5 |
| <b>AVAILABLE FINISHES:</b> BLACK (BL) & TITANIUM (TT)  |              |      |      |      |      |      |
| <ul style="list-style-type: none"> <li>• MAXIMUM ADDITIONAL WEIGHT CAPACITY - 220LBS (HEAVY-DUTY CASTERS)</li> <li>• OPTIONAL CUSHION</li> <li>• MEETS &amp; EXCEEDS ANSI/BIFMA STANDARDS. INCLUDES PENCIL TRAY</li> </ul> |              |      |      |      |      |      |

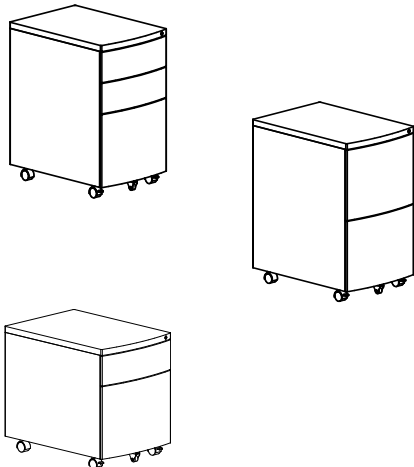

## FRAMEWORK PEDESTALS MOBILE PEDESTALS

| MODEL | LIST | WEIGHT | CUBE            | W  | D  | H  |
|-------|------|--------|-----------------|----|----|----|
|       |      | LBS    | FT <sup>3</sup> | IN | IN | IN |

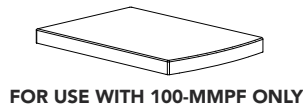

### OPTIONAL METAL MOBILE PEDESTAL CUSHION

FOR USE WITH 100-MMPF ONLY

|                 |       |     |      |       |      |   |
|-----------------|-------|-----|------|-------|------|---|
| 100-MMPF-CUSHFA | \$133 | 7.7 | 0.49 | 15.25 | 22.5 | 2 |
|-----------------|-------|-----|------|-------|------|---|

AVAILABLE SEAT CUSHION FINISH: CUSHFA - BLACK (BL), BLUE (BU), LIGHT GREY (GR), RED (RD) & ORANGE (OR)

|                 |       |     |      |       |      |   |
|-----------------|-------|-----|------|-------|------|---|
| 100-MMPF-CUSHPU | \$133 | 7.7 | 0.49 | 15.25 | 22.5 | 2 |
|-----------------|-------|-----|------|-------|------|---|

AVAILABLE SEAT CUSHION FINISH: CUSHPU - BLACK POLYURETHANE (BL)

## MOBILE PEDESTALS LAMINATE

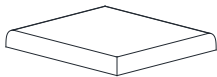
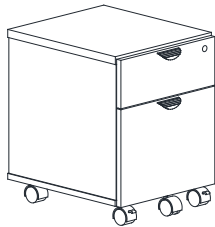

### MOBILE BOX/FILE PEDESTAL

ALL DRAWERS LOCK.

|             |       |    |     |       |       |       |
|-------------|-------|----|-----|-------|-------|-------|
| FRM-1622MPF | \$794 | 65 | 4.9 | 15.75 | 18.75 | 21.75 |
|-------------|-------|----|-----|-------|-------|-------|

- CAN ADD OPTIONAL MOBILE PED CUSHION- SEE BELOW.

### MOBILE PEDESTAL CUSHION

FABRIC COVERED CUSHION TO SUIT FRM-1622MPF ONLY. AVAILABLE IN THREE FABRIC OPTIONS IN A VARIETY OF COLOURS.

**ESCAPE:** 100% POLYESTER, JACQUARD WOVEN OR 100% POLYESTER, SOLID PLAIN WEAVE

|                  |       |   |   |    |    |      |
|------------------|-------|---|---|----|----|------|
| FRM-MPEDCUSH-ESC | \$409 | 4 | 1 | 16 | 18 | 1.75 |
|------------------|-------|---|---|----|----|------|

**HEAVENLY:** 20% RAYON, 80% POLYESTER, SOLID PLAIN WEAVE

|                  |       |   |   |    |    |      |
|------------------|-------|---|---|----|----|------|
| FRM-MPEDCUSH-HEA | \$442 | 4 | 1 | 16 | 18 | 1.75 |
|------------------|-------|---|---|----|----|------|

**ULTRALEATHER:** 100% PVC ANTI-BACTERIAL ULTRALEATHER

|                  |       |   |   |    |    |      |
|------------------|-------|---|---|----|----|------|
| FRM-MPEDCUSH-ULT | \$475 | 4 | 1 | 16 | 18 | 1.75 |
|------------------|-------|---|---|----|----|------|

PLEASE REFER TO THE FINISHES & FABRICS TAB ON THE [WWW.HEARTWOOD.CA](http://WWW.HEARTWOOD.CA) WEBSITE FOR A COMPLETE LISTING OF THE COLOUR CHOICES AVAILABLE IN EACH FABRIC.

## FRAMEWORK STORAGE OVERHEAD STORAGE

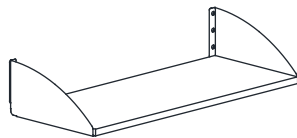

RTA

### OVERHEAD SHELF

HEIGHT ADJUSTABLE. INCLUDES OVERHEAD SHELF BRACKETS. MUST BE INSTALLED ON A PANEL OF EQUAL WIDTH.

3/4" MELAMINE SHELF

|           |       |    |     |       |    |   |
|-----------|-------|----|-----|-------|----|---|
| FRM-OSS24 | \$138 | 10 | 0.3 | 23.75 | 12 | 6 |
|-----------|-------|----|-----|-------|----|---|

|           |       |    |     |      |    |   |
|-----------|-------|----|-----|------|----|---|
| FRM-OSS30 | \$149 | 13 | 0.4 | 29.5 | 12 | 6 |
|-----------|-------|----|-----|------|----|---|

|           |       |    |     |      |    |   |
|-----------|-------|----|-----|------|----|---|
| FRM-OSS36 | \$164 | 15 | 0.5 | 35.5 | 12 | 6 |
|-----------|-------|----|-----|------|----|---|

1" MELAMINE SHELF

|            |       |    |     |      |    |   |
|------------|-------|----|-----|------|----|---|
| FRM1-OSS42 | \$190 | 17 | 0.6 | 41.5 | 12 | 6 |
|------------|-------|----|-----|------|----|---|

|            |       |    |     |       |    |   |
|------------|-------|----|-----|-------|----|---|
| FRM1-OSS48 | \$202 | 18 | 0.6 | 47.25 | 12 | 6 |
|------------|-------|----|-----|-------|----|---|

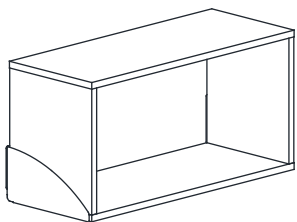

RTA

### OPEN OVERHEAD STORAGE

15" HIGH IN 3/4" MELAMINE W/ NO BACK. HEIGHT ADJUSTABLE W/ INCLUDED OVERHEAD SHELF BRACKETS. MUST BE INSTALLED ON A PANEL OF EQUAL WIDTH.

|             |       |    |     |       |    |    |
|-------------|-------|----|-----|-------|----|----|
| FRM-1524OSO | \$457 | 37 | 0.5 | 23.75 | 12 | 15 |
|-------------|-------|----|-----|-------|----|----|

|             |       |    |     |      |    |    |
|-------------|-------|----|-----|------|----|----|
| FRM-1530OSO | \$484 | 40 | 0.6 | 29.5 | 12 | 15 |
|-------------|-------|----|-----|------|----|----|

|             |       |    |     |      |    |    |
|-------------|-------|----|-----|------|----|----|
| FRM-1536OSO | \$502 | 43 | 0.7 | 35.5 | 12 | 15 |
|-------------|-------|----|-----|------|----|----|



| MODEL | LIST | AGD       | WEIGHT | CUBE            | W  | D  | H  |
|-------|------|-----------|--------|-----------------|----|----|----|
|       |      | UP-CHARGE | LBS    | FT <sup>3</sup> | IN | IN | IN |

**OVERHEAD STORAGE W/ HINGED DOORS**

15" HIGH IN 3/4" MELAMINE W/ NO BACK. HEIGHT ADJUSTABLE. INCLUDES OVERHEAD SHELF BRACKETS. MUST BE INSTALLED ON A PANEL OF EQUAL WIDTH.

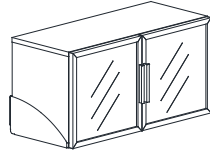
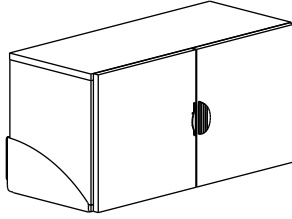

Optional AGD example:  
FRM-1530OSHD-AGD-FR

|              |       |       |    |     |       |       |    |
|--------------|-------|-------|----|-----|-------|-------|----|
| FRM-1524OSHD | \$725 | \$262 | 48 | 0.7 | 23.75 | 12.75 | 15 |
| FRM-1530OSHD | \$753 | \$339 | 53 | 0.8 | 29.5  | 12.75 | 15 |
| FRM-1536OSHD | \$772 | \$367 | 57 | 1   | 35.5  | 12.75 | 15 |

- DEFAULT SMALL SCOOP HANDLES. CHOICE OF HANDLES AND NO ADDITIONAL CHARGE SEE PAGE [100-<?>](#)

**LOCK NOT INCLUDED**

- TO LOCK OVERHEAD STORAGE DOORS. **ADD AN '-L'** TO ITEM # & ADD UPCHARGE OF **\$76** Example:FRM-1530OSHD-L

**\*OPTIONAL ALUMINUM GLAZED DOORS\***

- SELECT CLEAR (CL), FROSTED (FR) OR BRONZE (BR) PLEXI GLASS
- THE PRICE SHOWN FOR AGD DOORS IS AN UP-CHARGE THAT MUST BE ADDED TO THE BASE PRICE OF THE UNIT IT GOES ON.

Example: FRM-1524OSHD-AGD-FR

**RTA**

**MID-HEIGHT AND TALL STORAGE**

**388 MID-HEIGHT CLOSET CABINET**

INCLUDES COAT ROD. DRILLED FOR OPTIONAL BOOT SHELF. LOCKING.

HINGED LEFT

|                 |         |       |    |      |       |       |       |
|-----------------|---------|-------|----|------|-------|-------|-------|
| 388-4712MCL24-L | \$989   | \$438 | 74 | 8.7  | 11.75 | 23.75 | 46.75 |
| 388-4724MCL24-L | \$1,385 | \$544 | 90 | 16.9 | 23.75 | 23.75 | 46.75 |

HINGED RIGHT (SHOWN)

|                 |         |       |    |      |       |       |       |
|-----------------|---------|-------|----|------|-------|-------|-------|
| 388-4712MCL24-R | \$989   | \$438 | 74 | 8.7  | 11.75 | 23.75 | 46.75 |
| 388-4724MCL24-R | \$1,385 | \$544 | 90 | 16.9 | 23.75 | 23.75 | 46.75 |

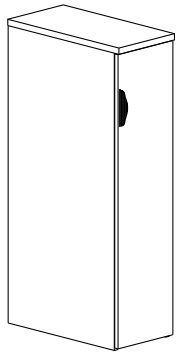

388-4712MCL24-R

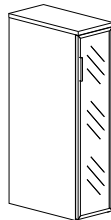

Optional AGD example:  
388-4712MCL24-R-AGD-FR

- DOOR LOCK OPTIONAL, **ADD AN '-L'** TO ITEM # & ADD UPCHARGE OF **\$76**  
Example: 388-4712MCL24-R-L

**\*OPTIONAL ALUMINUM GLAZED DOORS\***

- SELECT CLEAR (CL), FROSTED (FR) OR BRONZE (BR) PLEXI GLASS
- AGD DOORS INCLUDE SILVER FINISH BAR HANDLES. REFER TO [100-3](#) FOR OTHER HANDLE OPTIONS
- THE PRICE SHOWN FOR AGD DOORS IS AN UP-CHARGE THAT MUST BE ADDED TO THE BASE PRICE OF THE UNIT IT GOES ON.

Example: 388-4712MCL24-R-AGD-FR

**OPTIONAL BOOT SHELVES**

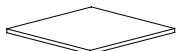

All tall & mid-height wardrobe storage & storage cabinets can have an optional boot shelf. Upcharges apply when ordering bootshelf: add **-BS** to product SKU.

> **ORDERING EXAMPLE: 388-4724CUFWL-24-BS**

|                                     |              |
|-------------------------------------|--------------|
| Bootshelf Upcharges<br>12"w to 23"w | <b>\$119</b> |
|-------------------------------------|--------------|

| MODEL | LIST | AGD       | WEIGHT | CUBE            | W  | D  | H  |
|-------|------|-----------|--------|-----------------|----|----|----|
|       |      | UP-CHARGE | LBS    | FT <sup>3</sup> | IN | IN | IN |

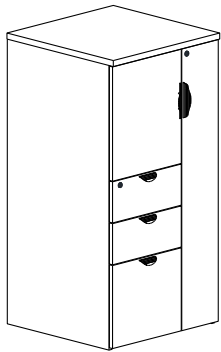

388-4724CUFWR-24

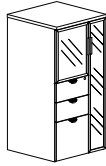

Optional AGD example:  
388-4724UFCL24-R-AGD-FR

**388 MID-HEIGHT WARDROBE STORAGE**

CABINET/BOX/BOX/FILE WARDROBE LEFT

|                  |         |       |     |      |       |       |       |
|------------------|---------|-------|-----|------|-------|-------|-------|
| 388-4724CUFWL-24 | \$1,658 | \$544 | 225 | 16.9 | 23.75 | 23.75 | 46.75 |
|------------------|---------|-------|-----|------|-------|-------|-------|

CABINET/BOX/BOX/FILE WARDROBE RIGHT

|                  |         |       |     |      |       |       |       |
|------------------|---------|-------|-----|------|-------|-------|-------|
| 388-4724CUFWR-24 | \$1,658 | \$544 | 225 | 16.9 | 23.75 | 23.75 | 46.75 |
|------------------|---------|-------|-----|------|-------|-------|-------|

- INCLUDES COAT ROD, 1 FIXED SHELF & 1 ADJUSTABLE SHELF. WARDROBE & DRAWERS ARE LOCKING. OPTIONAL LOCK ON CABINET DOOR.
- FOR OPTIONAL DOOR LOCK, **ADD AN '-L'** TO ITEM # & ADD UPCHARGE OF **\$76**  
**Example:** 388-4724CUFWR-24-L
- 20" DEPTH AVAILABLE. REPLACE -24 W/ -20 WHEN ORDERING & USE -24 PRICE. COAT ROD REPLACED W/ COAT HOOKS IN 20" UNITS.

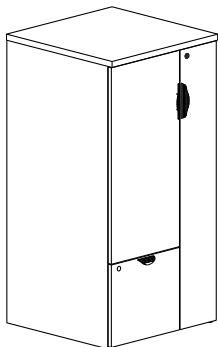

388-4724CFWR-24

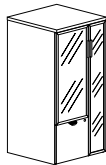

Optional AGD example:  
388-4724CFWR-24-AGD-FR

**388 MID-HEIGHT WARDROBE STORAGE**

CABINET/FILE WARDROBE LEFT

|                 |         |       |     |      |       |       |       |
|-----------------|---------|-------|-----|------|-------|-------|-------|
| 388-4724CFWL-24 | \$1,594 | \$762 | 202 | 16.9 | 23.75 | 23.75 | 46.75 |
|-----------------|---------|-------|-----|------|-------|-------|-------|

CABINET/FILE WARDROBE RIGHT

|                 |         |       |     |      |       |       |       |
|-----------------|---------|-------|-----|------|-------|-------|-------|
| 388-4724CFWR-24 | \$1,594 | \$762 | 202 | 16.9 | 23.75 | 23.75 | 46.75 |
|-----------------|---------|-------|-----|------|-------|-------|-------|

- INCLUDES COAT ROD, 1 FIXED SHELF & 1 ADJUSTABLE SHELF. WARDROBE & FILE DRAWER ARE LOCKING. OPTIONAL LOCK ON CABINET DOOR.
- FOR OPTIONAL DOOR LOCK, **ADD AN '-L'** TO ITEM # & ADD UPCHARGE OF **\$76**  
**Example:** 388-4724CFWR-24-L
- 20" DEPTH AVAILABLE. REPLACE -24 W/ -20 WHEN ORDERING & USE -24 PRICE. COAT ROD REPLACED W/ COAT HOOKS IN 20" UNITS.

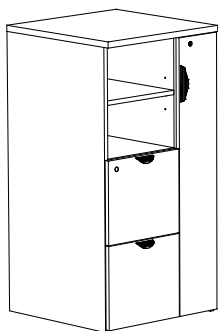

388-4724OFFWR-24

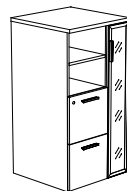

Optional AGD example:  
388-4724OFFWR-24-AGD-FR

**388 MID-HEIGHT OPEN WARDROBE STORAGE**

OPEN SHELF/FILE/FILE/WARDROBE LEFT

|                  |         |       |     |      |       |       |       |
|------------------|---------|-------|-----|------|-------|-------|-------|
| 388-4724OFFWL-24 | \$1,613 | \$544 | 189 | 16.9 | 23.75 | 23.75 | 46.75 |
|------------------|---------|-------|-----|------|-------|-------|-------|

OPEN SHELF/FILE/FILE/WARDROBE RIGHT

|                  |         |       |     |      |       |       |       |
|------------------|---------|-------|-----|------|-------|-------|-------|
| 388-4724OFFWR-24 | \$1,613 | \$544 | 189 | 16.9 | 23.75 | 23.75 | 46.75 |
|------------------|---------|-------|-----|------|-------|-------|-------|

- INCLUDES COAT ROD, 1 FIXED SHELF & 1 ADJUSTABLE SHELF. WARDROBE & DRAWERS ARE LOCKING.
- **\*OPTIONAL ALUMINUM GLAZED DOORS\***
- SELECT CLEAR (CL), FROSTED (FR) OR BRONZE (BR) PLEXI GLASS  
**Example:** 388-4724OFFWR-24-AGD-FR
- AGD DOORS INCLUDE SILVER FINISH BAR HANDLES. REFER TO **100-3** FOR OTHER HANDLE OPTIONS
- THE PRICE SHOWN FOR AGD DOORS IS AN UP-CHARGE THAT MUST BE ADDED TO THE BASE PRICE OF THE UNIT IT GOES ON.  
**Example:** 388-4724CFWL-24-AGD-FR
- 20" DEPTH AVAILABLE. REPLACE -24 W/ -20 WHEN ORDERING & USE -24 PRICE. COAT ROD REPLACED W/ COAT HOOKS IN 20" UNITS.

| MODEL | LIST | AGD       | WEIGHT | CUBE            | W  | D  | H  |
|-------|------|-----------|--------|-----------------|----|----|----|
|       |      | UP-CHARGE | LBS    | FT <sup>3</sup> | IN | IN | IN |

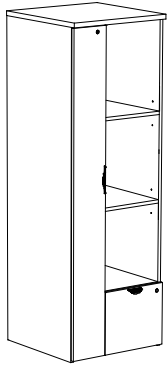

388-6524OFWL-24

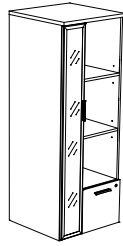

Optional AGD example:  
388-6524OFWR-24-AGD-FR

**388 TALL OPEN WARDROBE STORAGE**

OPEN SHELVES/FILE/WARDROBE LEFT

|                        |                |              |            |           |              |              |             |
|------------------------|----------------|--------------|------------|-----------|--------------|--------------|-------------|
| <b>388-6524OFWL-24</b> | <b>\$1,663</b> | <b>\$632</b> | <b>199</b> | <b>26</b> | <b>23.75</b> | <b>23.75</b> | <b>64.5</b> |
|------------------------|----------------|--------------|------------|-----------|--------------|--------------|-------------|

OPEN SHELVES/FILE/WARDROBE RIGHT

|                        |                |              |            |           |              |              |             |
|------------------------|----------------|--------------|------------|-----------|--------------|--------------|-------------|
| <b>388-6524OFWR-24</b> | <b>\$1,663</b> | <b>\$632</b> | <b>199</b> | <b>26</b> | <b>23.75</b> | <b>23.75</b> | <b>64.5</b> |
|------------------------|----------------|--------------|------------|-----------|--------------|--------------|-------------|

- INCLUDES COAT ROD & HAT SHELF. LOCKING FILE DRAWER & WARDROBE.
- 1 FIXED SHELF & 2 ADJUSTABLE SHELVES
- 20" DEPTH AVAILABLE. REPLACE -24 W/ -20 WHEN ORDERING & USE -24 PRICE. COAT ROD REPLACED W/ COAT HOOKS IN 20" UNITS.
- THE PRICE SHOWN FOR AGD DOORS IS AN UP-CHARGE THAT MUST BE ADDED TO THE BASE PRICE OF THE UNIT IT GOES ON.  
**Example:** 388-6524OFWR-24-AGD-FR

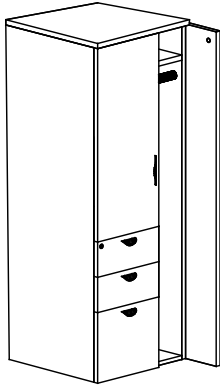

388-6524CUFWR-24

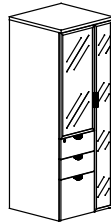

Optional AGD example:  
388-6524CUFWR-24-AGD-FR

**388 TALL WARDROBE STORAGE**

CABINET/BOX/BOX/FILE WARDROBE LEFT.

|                         |                |                |            |           |              |              |             |
|-------------------------|----------------|----------------|------------|-----------|--------------|--------------|-------------|
| <b>388-6524CUFWL-24</b> | <b>\$2,281</b> | <b>\$1,031</b> | <b>240</b> | <b>26</b> | <b>23.75</b> | <b>23.75</b> | <b>64.5</b> |
|-------------------------|----------------|----------------|------------|-----------|--------------|--------------|-------------|

CABINET/BOX/BOX/FILE WARDROBE RIGHT.

|                         |                |                |            |           |              |              |             |
|-------------------------|----------------|----------------|------------|-----------|--------------|--------------|-------------|
| <b>388-6524CUFWR-24</b> | <b>\$2,281</b> | <b>\$1,031</b> | <b>240</b> | <b>26</b> | <b>23.75</b> | <b>23.75</b> | <b>64.5</b> |
|-------------------------|----------------|----------------|------------|-----------|--------------|--------------|-------------|

- INCLUDES COAT ROD, HAT SHELF. WARDROBE & DRAWERS ARE LOCKING. OPTIONAL LOCK ON CABINET DOOR.
- FOR OPTIONAL DOOR LOCK, **ADD AN '-L'** TO ITEM # & ADD **\$76** TO THE RETAIL PRICE.  
**Example:** 388-6524CUFWL-24-L
- THE PRICE SHOWN FOR AGD DOORS IS AN UP-CHARGE THAT MUST BE ADDED TO THE BASE PRICE OF THE UNIT IT GOES ON.  
**Example:** 388-6524CUFWR-24-AGD-FR
- 20" DEPTH AVAILABLE. REPLACE -24 W/ -20 WHEN ORDERING & USE -24 PRICE. COAT ROD REPLACED W/ COAT HOOKS IN 20" UNITS.

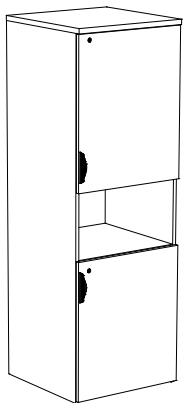

388-6524COC-R-24

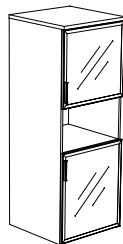

Optional AGD example:  
388-6524OFWR-24-AGD-FR

**388 TALL STORAGE CABINETS**

SINGLE DOOR CABINET/OPEN SHELF/SINGLE DOOR CABINET - HINGED LEFT

|                         |                |              |            |             |              |              |             |
|-------------------------|----------------|--------------|------------|-------------|--------------|--------------|-------------|
| <b>388-6516COC-L-24</b> | <b>\$1,347</b> | <b>\$640</b> | <b>160</b> | <b>18.8</b> | <b>15.75</b> | <b>23.75</b> | <b>64.5</b> |
|-------------------------|----------------|--------------|------------|-------------|--------------|--------------|-------------|

|                         |                |              |            |           |              |              |             |
|-------------------------|----------------|--------------|------------|-----------|--------------|--------------|-------------|
| <b>388-6524COC-L-24</b> | <b>\$1,477</b> | <b>\$694</b> | <b>180</b> | <b>26</b> | <b>23.75</b> | <b>23.75</b> | <b>64.5</b> |
|-------------------------|----------------|--------------|------------|-----------|--------------|--------------|-------------|

SINGLE DOOR CABINET/OPEN SHELF/SINGLE DOOR CABINET - HINGED RIGHT

|                         |                |              |            |             |              |              |             |
|-------------------------|----------------|--------------|------------|-------------|--------------|--------------|-------------|
| <b>388-6516COC-R-24</b> | <b>\$1,347</b> | <b>\$640</b> | <b>160</b> | <b>18.8</b> | <b>15.75</b> | <b>23.75</b> | <b>64.5</b> |
|-------------------------|----------------|--------------|------------|-------------|--------------|--------------|-------------|

|                         |                |              |            |           |              |              |             |
|-------------------------|----------------|--------------|------------|-----------|--------------|--------------|-------------|
| <b>388-6524COC-R-24</b> | <b>\$1,477</b> | <b>\$694</b> | <b>180</b> | <b>26</b> | <b>23.75</b> | <b>23.75</b> | <b>64.5</b> |
|-------------------------|----------------|--------------|------------|-----------|--------------|--------------|-------------|

- 1 FIXED SHELF & 1 ADJUSTABLE SHELF IN EACH CABINET.
- LOCKING CABINETS.
- 20" DEPTH AVAILABLE. REPLACE -24 W/ -20 WHEN ORDERING & USE -24 PRICE.

\*OPTIONAL ALUMINUM GLAZED DOORS\*

- SELECT CLEAR (CL), FROSTED (FR) OR BRONZE (BR) PLEXI GLASS  
**Example:** 388-6524COC-R-24-AGD-FR
- AGD DOORS INCLUDE SILVER FINISH BAR HANDLES. REFER TO **100-3** FOR OTHER HANDLE OPTIONS
- THE PRICE SHOWN FOR AGD DOORS IS AN UP-CHARGE THAT MUST BE ADDED TO THE BASE PRICE OF THE UNIT IT GOES ON.  
**Example:** 388-6516COC-R-24 -AGD-FR

# FRAMEWORK WORK SURFACE SUPPORTS

## PANEL EXTENSIONS

**NEW!**

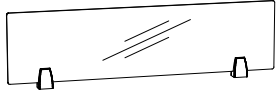

FRM-1030PLX

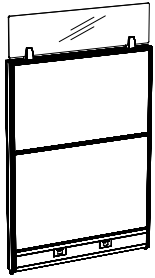

PANEL MOUNT

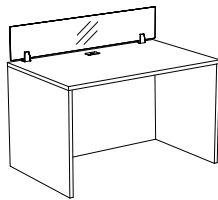

WORK SURFACE MOUNT

### PLEXIGLASS PANEL EXTENSION

INCLUDES ALL MOUNTING HARDWARE.

#### 2 TOP MOUNTING BRACKETS

| MODEL        | LIST  | WEIGHT<br>LBS | CUBE<br>FT <sup>3</sup> | W<br>IN | D<br>IN | H<br>IN |
|--------------|-------|---------------|-------------------------|---------|---------|---------|
| FRM1-1024PLX | \$213 | 3.2           | 0.1                     | 23.25   | .25     | 9.75    |
| FRM1-1030PLX | \$233 | 3.8           | 0.12                    | 29.25   | .25     | 9.75    |
| FRM1-1036PLX | \$245 | 4.3           | 0.14                    | 35      | .25     | 9.75    |
| FRM1-1042PLX | \$250 | 4.7           | 0.15                    | 41      | .25     | 9.75    |
| FRM1-1048PLX | \$264 | 5.3           | 0.17                    | 47      | .25     | 9.75    |

#### 3 TOP MOUNTING BRACKETS

|              |       |     |      |       |      |      |
|--------------|-------|-----|------|-------|------|------|
| FRM1-1054PLX | \$319 | 5.8 | 0.19 | 52.75 | 0.25 | 9.75 |
| FRM1-1060PLX | \$346 | 6.2 | 0.21 | 58.75 | 0.25 | 9.75 |
| FRM1-1066PLX | \$365 | 6.6 | 0.23 | 64.5  | 0.25 | 9.75 |
| FRM1-1072PLX | \$394 | 7.1 | 0.25 | 70.5  | 0.25 | 9.75 |
| FRM1-1078PLX | \$422 | 7.5 | 0.27 | 76.5  | 0.25 | 9.75 |

#### 4 TOP MOUNTING BRACKETS

|              |       |     |      |       |      |      |
|--------------|-------|-----|------|-------|------|------|
| FRM1-1084PLX | \$451 | 8.6 | 0.29 | 82.25 | 0.25 | 9.75 |
| FRM1-1090PLX | \$500 | 9.0 | 0.31 | 88.25 | 0.25 | 9.75 |
| FRM1-1096PLX | \$527 | 9.4 | 0.33 | 94.25 | 0.25 | 9.75 |

PANEL FINISH: FROSTED (FR) OR CLEAR (CL) PLEXIGLASS

BRACKET FINISHES: SILVER (SL) OR BLACK (BL). DEFAULT FINISH WILL BE SILVER UNLESS OTHERWISE SPECIFIED

- CAN BE INSTALLED ON 48" OR 66" HIGH FRAMEWORK MODULAR PANELS, ON THIRD PARTY MODULAR PANEL DESIGNS OR USED IN WORK SURFACE MOUNT APPLICATIONS.

**RTA**

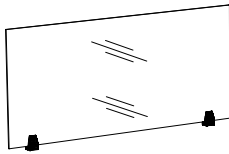

FRM1-2248CLG (SHOWN)

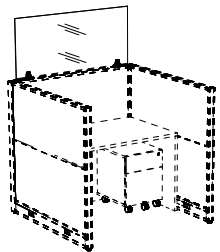

PANEL MOUNT

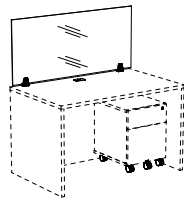

WORK SURFACE MOUNT

### TEMPERED GLASS PANEL EXTENSION

TOP MOUNT - MOUNT ON FRAMEWORK PANELS, 3RD PARTY PARTITION PANELS OR DESKTOP

#### 2 TOP MOUNTING BRACKETS

|              |       |      |      |       |      |       |
|--------------|-------|------|------|-------|------|-------|
| FRM1-2224CLG | \$454 | 9.9  | 0.34 | 23.25 | 0.25 | 21.75 |
| FRM1-2230CLG | \$475 | 12.1 | 0.42 | 29.25 | 0.25 | 21.75 |
| FRM1-2236CLG | \$504 | 14.3 | 0.50 | 35    | 0.25 | 21.75 |
| FRM1-2242CLG | \$553 | 16.5 | 0.58 | 41    | 0.25 | 21.75 |
| FRM1-2248CLG | \$600 | 18.7 | 0.66 | 47    | 0.25 | 21.75 |

#### 3 TOP MOUNTING BRACKETS

|              |       |      |      |       |      |       |
|--------------|-------|------|------|-------|------|-------|
| FRM1-2260CLG | \$614 | 23.1 | 0.82 | 58.75 | 0.25 | 21.75 |
| FRM1-2266CLG | \$659 | 25.4 | 0.89 | 64.5  | 0.25 | 21.75 |
| FRM1-2272CLG | \$704 | 27.6 | 0.98 | 70.5  | 0.25 | 21.75 |

BRACKET FINISH: SILVER (SL) OR BLACK (BL)

PANEL FINISH: 5MM CLEAR TEMPERED GLASS

- SUITABLE FOR DESKTOP MOUNTING APPLICATIONS
- POLISHED EDGES, "TOUCH" CORNERS ARE STANDARD
- OPTIONAL RADIUS CORNERS ADD -R TO SKU, INCLUDES BOTH UPPER CORNERS.

UPCHARGE OF **\$58**

**RTA**

**Caution:** Mounting to panels, installer must ensure panel is stable to avoid tipping.

| MODEL | LIST | WEIGHT | CUBE            | W  | D  | H  |
|-------|------|--------|-----------------|----|----|----|
|       |      | LBS    | FT <sup>3</sup> | IN | IN | IN |

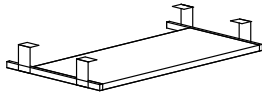

**KEYBOARD DRAWER**

EXTRA WIDTH FOR MOUSE

|          |       |    |   |    |       |      |
|----------|-------|----|---|----|-------|------|
| 100-KD28 | \$202 | 10 | 1 | 28 | 11.25 | 3.25 |
|----------|-------|----|---|----|-------|------|

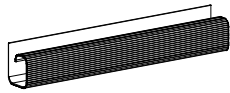

**WIRE MANAGEMENT CHANNEL**

12" LONG

|        |      |   |     |    |     |   |
|--------|------|---|-----|----|-----|---|
| 100-CC | \$20 | 1 | 0.1 | 16 | 1.5 | 1 |
|--------|------|---|-----|----|-----|---|

**AVAILABLE FINISH:** BLACK PLASTIC (BL)

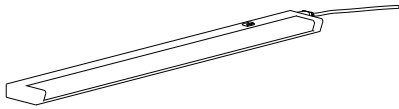

**TASK LIGHTS - FLUORESCENT**

24" TASK LIGHT

|          |       |     |      |       |     |      |
|----------|-------|-----|------|-------|-----|------|
| 100-24TL | \$361 | 2.1 | 0.11 | 24.75 | 3.5 | 1.25 |
|----------|-------|-----|------|-------|-----|------|

36" TASK LIGHT

|          |       |     |      |       |     |      |
|----------|-------|-----|------|-------|-----|------|
| 100-36TL | \$382 | 2.8 | 0.11 | 36.75 | 3.5 | 1.25 |
|----------|-------|-----|------|-------|-----|------|

48" TASK LIGHT

|          |       |   |      |       |     |      |
|----------|-------|---|------|-------|-----|------|
| 100-48TL | \$473 | 3 | 0.14 | 48.75 | 3.5 | 1.25 |
|----------|-------|---|------|-------|-----|------|

WHEN ORDERING TASKLIGHTS, PLEASE KEEP IN MIND:

- STANDARD HUTCHES DO NOT INCLUDE A GROMMET
- A CORD SWEEP IS INCLUDED ON THE BOTTOM OF THE HUTCH BACK
- TASKLIGHT INCLUDES A 9 FT. LONG CORD.
- DUE TO SLIMLINE DESIGN, TASKLIGHTS DO NOT REQUIRE A VALANCE.
- SWITCH AND CORD ARE ON THE RIGHT END

**AVAILABLE FINISH:** BLACK (BL)

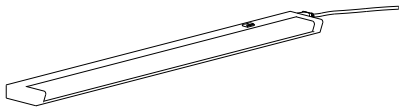

**LED TASK LIGHTS**

24" LED TASK LIGHT

|             |       |    |     |    |     |     |
|-------------|-------|----|-----|----|-----|-----|
| 100-LED24TL | \$315 | 2. | 0.1 | 24 | 3.5 | 1.1 |
|-------------|-------|----|-----|----|-----|-----|

36" LED TASK LIGHT

|             |       |     |       |       |     |      |
|-------------|-------|-----|-------|-------|-----|------|
| 100-LED36TL | \$437 | 2.8 | 0.105 | 36.75 | 3.5 | 1.25 |
|-------------|-------|-----|-------|-------|-----|------|

48" LED TASK LIGHT

|             |       |   |      |       |     |      |
|-------------|-------|---|------|-------|-----|------|
| 100-LED48TL | \$535 | 3 | 0.14 | 48.75 | 3.5 | 1.25 |
|-------------|-------|---|------|-------|-----|------|

- BUILT-IN ON/OFF OCCUPANCY SENSOR
- 160° SWIVEL FEATURE TO POSITION THE LIGHT WHERE NEEDED.
- 11 WATTS UL LISTED
- INCLUDES: 5' GROUNDED POWER CORD, MAGNET FOR METAL SHELF INSTALLATION AND SCREW KIT FOR WOOD SHELF MOUNTING

**AVAILABLE FINISH:** ALUMINIUM (AL)

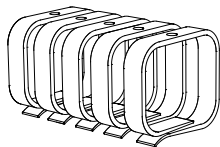

**WIRE MANAGEMENT KIT**

INCLUDES 5 WIRE HANGERS AND MOUNTING HARDWARE.

|          |      |     |     |   |   |     |
|----------|------|-----|-----|---|---|-----|
| 100-WIRE | \$73 | 0.2 | 0.0 | 2 | 2 | 2.5 |
|----------|------|-----|-----|---|---|-----|

**AVAILABLE FINISH:** LIGHT GREY (GR)

ORDER HDL FRAMEWORK PANELS THROUGH HDL.  
FOR DETAILS CHECK ONLINE AT [www.heartwoodDL.com](http://www.heartwoodDL.com) OR REFER TO FRM TAB IN THE HDL PRICER.

|                                | ITEMS  | ITEM DESCRIPTION             | QTY            | LIST           |
|--------------------------------|--|------------------------------|----------------|----------------|
| <b>LAYOUT #1- BASIC LAYOUT</b> | <b>HDL FRAMEWORK PANEL SYSTEM COMPONENTS</b> |                              |                |                |
|                                | FRM-6066P                                    | 66" TALL PANEL               |                | \$872          |
|                                | FRM-3666P                                    | 66" TALL PANEL               |                | \$600          |
|                                | FRM-2466P                                    | 66" TALL PANEL               |                | \$457          |
|                                | FRM-66SQP-2W                                 | SQUARE 2 WAY CONNECTING POST |                | \$109          |
|                                | FRM-66PET                                    | PANEL END TRIM               | 2 X            | \$32           |
|                                | FRM-PCK                                      | PANEL CONNECTING KIT         |                | \$40           |
|                                | PANEL COMPONENT TOTAL=                       |                              |                | <b>\$2,142</b> |
|                                | <b>HEARTWOOD COMPONENTS</b>                  |                              |                |                |
|                                | FRM-362460ECM                                | EXTENDED CORNER MODULE       |                | \$545          |
| FRM-2424WS                     | WORK SURFACE                                 |                              | \$196          |                |
| FRM-GF24                       | FULL GABLE                                   |                              | \$266          |                |
| FRM-WFBK                       | WORK SURFACE FLUSH BRACKET KIT               |                              | \$38           |                |
| FRM-1624FPUFX                  | FREESTANDING BOX/BOX/FILE PEDESTAL           |                              | \$899          |                |
| FURNITURE COMPONENT TOTAL=     |  |                              | <b>\$1,944</b> |                |

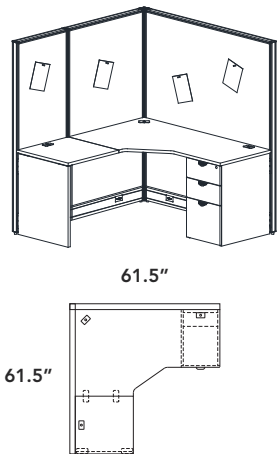

|                            |  |                                    |                |                |
|----------------------------|--|------------------------------------|----------------|----------------|
| <b>LAYOUT #2- LINEAR</b>   | <b>HDL FRAMEWORK PANEL SYSTEM COMPONENTS</b> |                                    |                |                |
|                            | FRM-4848P                                    | 48" TALL PANEL                     | 3 X            | \$560          |
|                            | FRM-4248P                                    | 48" TALL PANEL                     | 4 X            | \$525          |
|                            | FRM-48PET                                    | PANEL END TRIM                     | 4 X            | \$29           |
|                            | FRM-48SQP-2W                                 | SQUARE 2 WAY CONNECTING POST       | 2 X            | \$90           |
|                            | FRM-48SQP-3W                                 | SQUARE 3 WAY CONNECTING POST       | 2 X            | \$104          |
|                            | PANEL COMPONENT TOTAL=                       |                                    |                | <b>\$4,284</b> |
|                            | <b>HEARTWOOD COMPONENTS</b>                  |                                    |                |                |
|                            | FRM-2448WS                                   | WORK SURFACE                       | 3 X            | \$244          |
|                            | FRM-1624FPUFX                                | FREESTANDING BOX/BOX/FILE PEDESTAL | 3 X            | \$899          |
| FURNITURE COMPONENT TOTAL= |  |                                    | <b>\$3,429</b> |                |

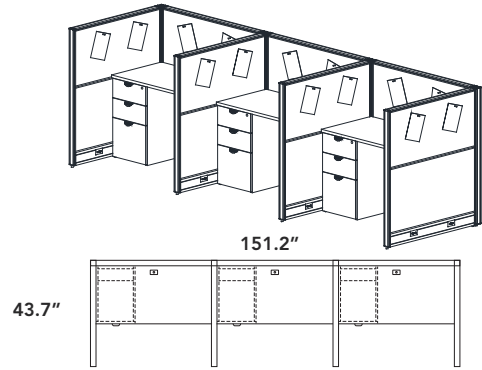

|                                   |  |                              |                |                |
|-----------------------------------|--|------------------------------|----------------|----------------|
| <b>LAYOUT #3- LINEAR BENCHING</b> | <b>HDL FRAMEWORK PANEL SYSTEM COMPONENTS</b> |                              |                |                |
|                                   | FRM-3066P                                    | 66" TALL PANEL               | 3 X            | \$509          |
|                                   | FRM-3066GP                                   | 66" TALL CLEAR GLAZED PANEL  | 3 X            | \$673          |
|                                   | FRM-2448P                                    | 48" TALL PANEL               | 4 X            | \$360          |
|                                   | FRM-66SQP-4W                                 | SQUARE 4 WAY CONNECTING POST | 2 X            | \$133          |
|                                   | FRM-66PET                                    | PANEL END TRIM               | 2 X            | \$32           |
|                                   | FRM-48PET                                    | PANEL END TRIM               | 4 X            | \$29           |
|                                   | FRM-PCK                                      | PANEL CONNECTING KIT         | 3 X            | \$40           |
|                                   | PANEL COMPONENT TOTAL=                       |                              |                | <b>\$5,552</b> |
|                                   | <b>HEARTWOOD COMPONENTS</b>                  |                              |                |                |
| FRM-OSS30                         | OVERHEAD SHELF                               |                              | \$149          |                |
| FRM-1530OSO                       | OPEN OVERHEAD STORAGE                        |                              | \$484          |                |
| FRM-1530OSHD                      | OVERHEAD STORAGE W/ HINGED DOORS             |                              | \$753          |                |
| FRM-2460WS                        | WORK SURFACE                                 | 6 X                          | \$352          |                |
| FRM-ML24-L                        | METAL LEG                                    | 2 X                          | \$215          |                |
| FRM-ML24-R                        | METAL LEG                                    | 2 X                          | \$215          |                |
| FRM-1624FPUFX                     | FREESTANDING BOX/BOX/FILE PEDESTAL           | 6 X                          | \$899          |                |
| FURNITURE COMPONENT TOTAL=        |  |                              | <b>\$9,752</b> |                |

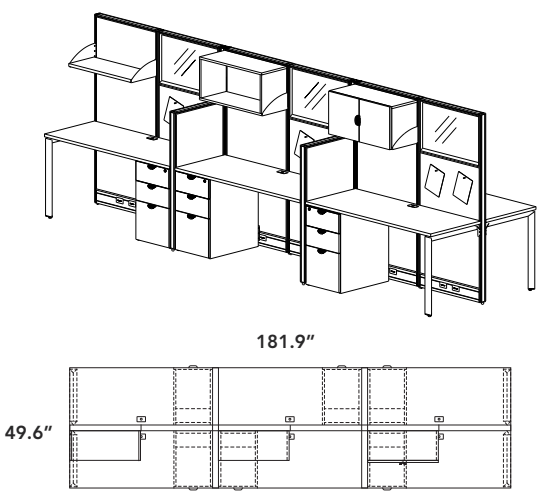

ORDER HDL FRAMEWORK PANELS THROUGH HDL.  
FOR DETAILS CHECK ONLINE AT [www.heartwoodDL.com](http://www.heartwoodDL.com) OR REFER TO FRM TAB IN THE HDL PRICER.

**LAYOUT #4  
- LINEAR CUBICLE**

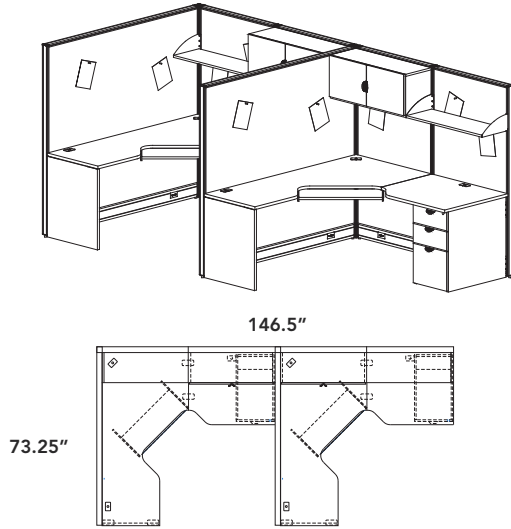

| ITEMS  | ITEM DESCRIPTION             | QTY | LIST           |
|--|------------------------------|-----|----------------|
| <b>HDL FRAMEWORK PANEL SYSTEM COMPONENTS</b> |                              |     |                |
| FRM-7266P                                    | 66" TALL PANEL               | 2 X | \$1105         |
| FRM-3666P                                    | 66" TALL PANEL               | 4 X | \$600          |
| FRM-66SQP-3W                                 | SQUARE 3 WAY CONNECTING POST |     | \$122          |
| FRM-66SQP-2W                                 | SQUARE 2 WAY CONNECTING POST |     | \$109          |
| FRM-66PET                                    | PANEL END TRIM               | 3 X | \$32           |
| FRM-PCK                                      | PANEL CONNECTING KIT         | 2 X | \$40           |
| PANEL COMPONENT TOTAL=                       |                              |     | <b>\$5,017</b> |

|                             |                                    |     |                |
|-----------------------------|------------------------------------|-----|----------------|
| <b>HEARTWOOD COMPONENTS</b> |                                    |     |                |
| FRM-362472SECM              | SHAPED EXTENDED CORNER MODULE      | 2 X | \$692          |
| FRM-302436CC                | CUTBACK CONNECTOR                  | 2 X | \$236          |
| FRM-GF24                    | FULL GABLE                         | 2 X | \$266          |
| FRM-1630FPUFX               | FREESTANDING BOX/BOX/FILE PEDESTAL | 2 X | \$944          |
| FRM-OSS36                   | OVERHEAD SHELF                     | 2 X | \$164          |
| FRM-1536OSHD                | OVERHEAD STORAGE W/ HINGED DOORS   | 2 X | \$772          |
| FRM-WFBK                    | WORK SURFACE FLUSH BRACKET KIT     | 2 X | \$38           |
| 100-KD28                    | KEYBOARD DRAWER                    | 2 X | \$202          |
| FURNITURE COMPONENT TOTAL=  |                                    |     | <b>\$6,628</b> |

**LAYOUT #5  
- LINEAR CUBICLE**

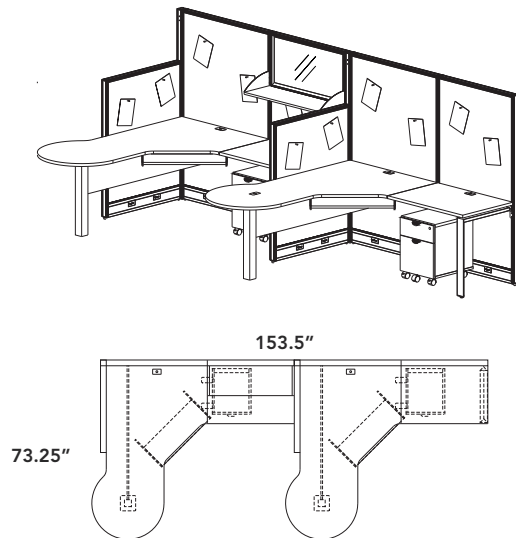

|  |                              |     |                |
|--|------------------------------|-----|----------------|
| <b>HDL FRAMEWORK PANEL SYSTEM COMPONENTS</b> |                              |     |                |
| FRM-3648P                                    | 48" TALL PANEL               | 2 X | \$490          |
| FRM-4266P                                    | 66" TALL PANEL               | 2 X | \$688          |
| FRM-3666GP                                   | 66" TALL CLEAR GLAZED PANEL  |     | \$777          |
| FRM-3666P                                    | 66" TALL PANEL               |     | \$600          |
| FRM-66SQP-2W                                 | SQUARE 2 WAY CONNECTING POST |     | \$109          |
| FRM-66SQP-3W                                 | SQUARE 3 WAY CONNECTING POST |     | \$122          |
| FRM-66PET                                    | PANEL END TRIM               |     | \$32           |
| FRM-48PET                                    | PANEL END TRIM               | 2 X | \$29           |
| FRM-PCK                                      | PANEL CONNECTING KIT         | 2 X | \$40           |
| PANEL COMPONENT TOTAL=                       |                              |     | <b>\$4,134</b> |

|                             |                                |     |                |
|-----------------------------|--------------------------------|-----|----------------|
| <b>HEARTWOOD COMPONENTS</b> |                                |     |                |
| FRM-422472CMPTM-2           | CORNER MODULE PENINSULA TOP    | 2 X | \$1,111        |
| FRM-2436WS                  | WORK SURFACE                   | 2 X | \$212          |
| FRM-WFBK                    | WORK SURFACE FLUSH BRACKET KIT | 2 X | \$38           |
| FRM-ML24-R                  | METAL LEG                      |     | \$215          |
| FRM-1622MPF                 | MOBILE BOX/FILE PEDESTAL       | 2 X | \$794          |
| FRM-OSS36                   | OVERHEAD SHELF                 |     | \$164          |
| 100-KD28                    | KEYBOARD DRAWER                | 2 X | \$202          |
| FURNITURE COMPONENT TOTAL=  |                                |     | <b>\$5,093</b> |

ORDER HDL FRAMEWORK PANELS THROUGH HDL.  
FOR DETAILS CHECK ONLINE AT [www.heartwoodDL.com](http://www.heartwoodDL.com) OR REFER TO FRM TAB IN THE HDL PRICER.

## LAYOUT #6 - LINEAR CUBICLE

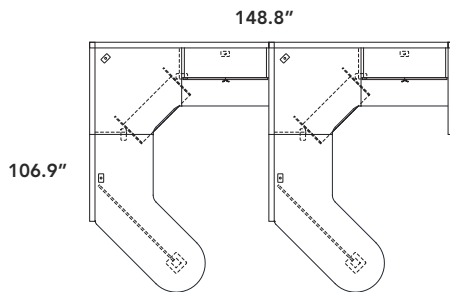
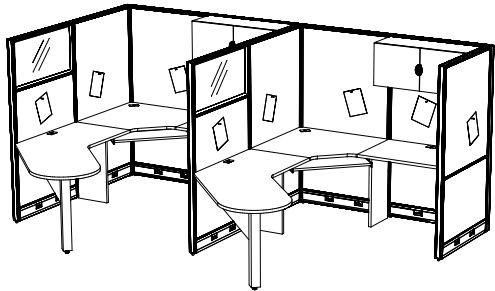

| ITEMS  | ITEM DESCRIPTION             | QTY | LIST  |
|--|------------------------------|-----|-------|
| <b>HDL FRAMEWORK PANEL SYSTEM COMPONENTS</b> |                              |     |       |
| FRM-3666P                                    | 66" TALL PANEL               | 7 X | \$600 |
| FRM-3666GP                                   | 66" TALL CLEAR GLAZED PANEL  | 2 X | \$777 |
| FRM-66SQP-2W                                 | SQUARE 2 WAY CONNECTING POST | 2 X | \$109 |
| FRM-66SQP-3W                                 | SQUARE 3 WAY CONNECTING POST |     | \$122 |
| FRM-PCK                                      | PANEL CONNECTING KIT         | 4 X | \$40  |
| FRM-66PET                                    | PANEL END TRIM               | 3 X | \$32  |

PANEL COMPONENT TOTAL= **\$6,350**

|                             |                                  |     |       |
|-----------------------------|----------------------------------|-----|-------|
| <b>HEARTWOOD COMPONENTS</b> |                                  |     |       |
| FRM-2436CM                  | 90° CORNER MODULE                | 2 X | \$413 |
| FRM-2436APM-2               | ANGLED PENINSULA TOP             | 2 X | \$671 |
| FRM-2436WS                  | WORK SURFACE                     | 2 X | \$212 |
| FRM-1536OSHD                | OVERHEAD STORAGE W/ HINGED DOORS | 2 X | \$772 |
| FRM-GH24                    | HALF GABLE                       | 4 X | \$257 |
| 100-KD28                    | KEYBOARD DRAWER                  | 2 X | \$202 |

FURNITURE COMPONENT TOTAL= **\$5,568**

## LAYOUT #7 - PRIVATE OFFICE

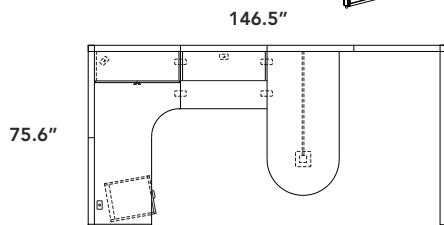
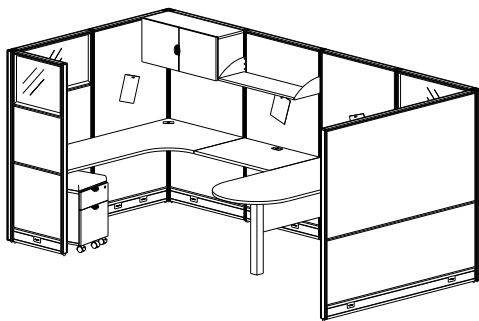

|  |                              |     |        |
|--|------------------------------|-----|--------|
| <b>HDL FRAMEWORK PANEL SYSTEM COMPONENTS</b> |                              |     |        |
| FRM-2466GP                                   | 66" TALL CLEAR GLAZED PANEL  |     | \$607  |
| FRM-3666GP                                   | 66" TALL CLEAR GLAZED PANEL  | 2 X | \$777  |
| FRM-3666P                                    | 66" TALL PANEL               | 4 X | \$600  |
| FRM-7266P                                    | 66" TALL PANEL               |     | \$1105 |
| FRM-66SQP-2W                                 | SQUARE 2 WAY CONNECTING POST | 3 X | \$109  |
| FRM-66PET                                    | PANEL END TRIM               | 2 X | \$32   |
| FRM-PCK                                      | PANEL CONNECTING KIT         | 4 X | \$40   |

PANEL COMPONENT TOTAL= **\$6,217**

|                             |                                   |     |       |
|-----------------------------|-----------------------------------|-----|-------|
| <b>HEARTWOOD COMPONENTS</b> |                                   |     |       |
| FRM-362472RECM              | RADIUSED EXTENDED CORNER MODULE   |     | \$692 |
| FRM-2436WS                  | WORK SURFACE                      |     | \$212 |
| FRM-3060BTM-2               | BULLET TOP                        |     | \$491 |
| FRM-1622MPF                 | MOBILE BOX/FILE PEDESTAL          |     | \$794 |
| FRM-MPEDCUSH-HEA            | MOBILE PEDESTAL CUSHION- HEAVENLY |     | \$442 |
| FRM-1536OSHD                | OVERHEAD STORAGE W/ HINGED DOORS  |     | \$772 |
| FRM-OSS36                   | OVERHEAD SHELF                    |     | \$164 |
| FRM-WFBK                    | WORK SURFACE FLUSH BRACKET KIT    | 2 X | \$38  |

FURNITURE COMPONENT TOTAL= **\$3,643**



ORDER HDL FRAMEWORK PANELS THROUGH HDL.  
FOR DETAILS CHECK ONLINE AT [www.heartwoodDL.com](http://www.heartwoodDL.com) OR REFER TO FRM TAB IN THE HDL PRICER.

**LAYOUT #8  
- RECEPTION**

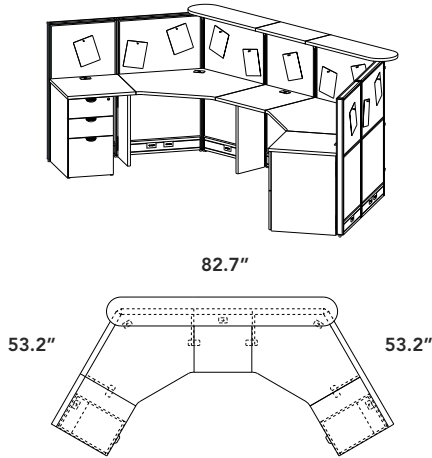

| ITEMS  | ITEM DESCRIPTION               | QTY | LIST           |
|--|--------------------------------|-----|----------------|
| <b>HDL FRAMEWORK PANEL SYSTEM COMPONENTS</b> |                                |     |                |
| FRM-2448P                                    | 48" TALL PANEL                 | 3 X | \$360          |
| FRM-3048P                                    | 48" TALL PANEL                 | 4 X | \$413          |
| FRM-48TRP-2W                                 | TRIANGLE 2 WAY CONNECTING POST | 2 X | \$108          |
| FRM-PCK                                      | PANEL CONNECTING KIT           | 4 X | \$40           |
| FRM-48PET                                    | PANEL END TRIM                 | 2 X | \$29           |
| PANEL COMPONENT TOTAL=                       |                                |     | <b>\$3,166</b> |

|                             |                                    |     |                |
|-----------------------------|------------------------------------|-----|----------------|
| <b>HEARTWOOD COMPONENTS</b> |                                    |     |                |
| FRM-1624FPUFX               | FREESTANDING BOX/BOX/FILE PEDESTAL |     | \$899          |
| FRM-1624FPFFX               | FREESTANDING FILE/FILE PEDESTAL    |     | \$899          |
| FRM-GH24                    | HALF GABLE                         | 4 X | \$257          |
| FRM-2430AC120               | 120° ANGLED CORNER                 | 2 X | \$446          |
| FRM3-1230DTA                | D TRANSACTION TOP                  | 2 X | \$154          |
| FRM3-1224TA                 | TRANSACTION TOP                    |     | \$120          |
| FRM-2424WS                  | WORK SURFACE                       | 3 X | \$196          |
| FURNITURE COMPONENT TOTAL=  |                                    |     | <b>\$4,734</b> |

NOTE: THIS CONFIGURATION HAS EXPOSED REMOVABLE HARDWARE, CALL CUSTOMER SERVICE FOR DETAILS.

**LAYOUT #9  
- SHARED CUBICLE**

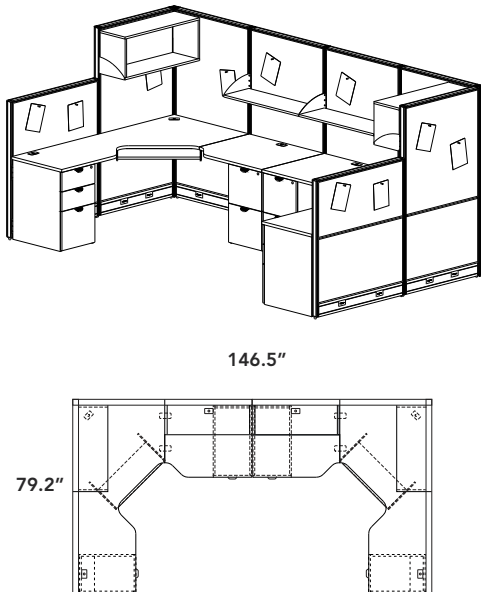

|  |                              |     |                |
|--|------------------------------|-----|----------------|
| <b>HDL FRAMEWORK PANEL SYSTEM COMPONENTS</b> |                              |     |                |
| FRM-4248P                                    | 48" TALL PANEL               | 2 X | \$525          |
| FRM-3666P                                    | 66" TALL PANEL               | 6 X | \$600          |
| FRM-PCK                                      | PANEL CONNECTING KIT         | 5 X | \$40           |
| FRM-66SQP-2W                                 | SQUARE 2 WAY CONNECTING POST | 2 X | \$109          |
| FRM-48PET                                    | PANEL END TRIM               | 2 X | \$29           |
| FRM-18PET                                    | PANEL END TRIM               | 2 X | \$20           |
| PANEL COMPONENT TOTAL=                       |                              |     | <b>\$5,166</b> |

|                             |                                    |     |                |
|-----------------------------|------------------------------------|-----|----------------|
| <b>HEARTWOOD COMPONENTS</b> |                                    |     |                |
| FRM-OSS36                   | OVERHEAD SHELF                     | 2 X | \$164          |
| FRM-362478SECM              | SHAPED EXTENDED CORNER MODULE      | 2 X | \$994          |
| FRM-302436CC                | CUTBACK CONNECTOR                  | 2 X | \$236          |
| FRM-1624FPUFX               | FREESTANDING BOX/BOX/FILE PEDESTAL | 2 X | \$899          |
| FRM-1536OSO                 | OPEN OVERHEAD STORAGE              | 2 X | \$502          |
| FRM-1630FPFFX               | FREESTANDING FILE/FILE PEDESTAL    | 2 X | \$944          |
| FRM-WFBK                    | WORK SURFACE FLUSH BRACKET KIT     | 2 X | \$38           |
| 100-KD28                    | KEYBOARD DRAWER                    | 2 X | \$202          |
| FURNITURE COMPONENT TOTAL=  |                                    |     | <b>\$7,958</b> |

ORDER HDL FRAMEWORK PANELS THROUGH HDL.  
FOR DETAILS CHECK ONLINE AT [www.heartwoodDL.com](http://www.heartwoodDL.com) OR REFER TO FRM TAB IN THE HDL PRICER.

**LAYOUT #10  
- 90° RADIAL**

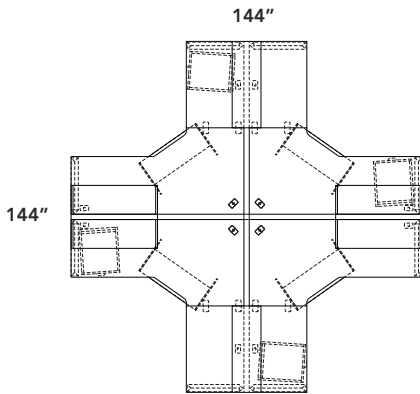
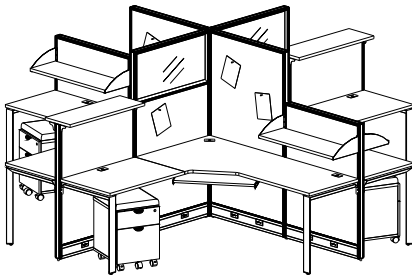

| ITEMS | ITEM DESCRIPTION | QTY | LIST |
|-------|------------------|-----|------|
|-------|------------------|-----|------|

**HDL FRAMEWORK PANEL SYSTEM COMPONENTS**

|                        |                              |     |                |
|------------------------|------------------------------|-----|----------------|
| FRM-3666P              | 66" TALL PANEL               | 2 X | \$600          |
| FRM-3666GP             | 66" TALL CLEAR GLAZED PANEL  | 2 X | \$777          |
| FRM-3648P              | 48" TALL PANEL               | 4 X | \$490          |
| FRM-66SQP-4W           | SQUARE 4 WAY CONNECTING POST |     | \$133          |
| FRM-18PET              | PANEL END TRIM               | 4 X | \$20           |
| FRM-48PET              | PANEL END TRIM               | 4 X | \$29           |
| FRM-PCK                | PANEL CONNECTING KIT         | 4 X | \$40           |
| PANEL COMPONENT TOTAL= |                              |     | <b>\$5,203</b> |

**HEARTWOOD COMPONENTS**

|                            |                                   |     |                 |
|----------------------------|-----------------------------------|-----|-----------------|
| FRM-362472ECM              | EXTENDED CORNER MODULE            | 4 X | \$692           |
| FRM-2436WS                 | WORK SURFACE                      | 4 X | \$212           |
| FRM3-1236TA                | TRANSACTION TOP                   | 2 X | \$147           |
| FRM-OSS36                  | OVERHEAD SHELF                    | 4 X | \$164           |
| FRM-ML24-R                 | METAL LEG                         | 4 X | \$215           |
| FRM-ML24-L                 | METAL LEG                         | 4 X | \$215           |
| FRM-WFBK                   | WORK SURFACE FLUSH BRACKET KIT    | 4 X | \$38            |
| FRM-1622MPF                | MOBILE BOX/FILE PEDESTAL          | 4 X | \$794           |
| FRM-MPEDCUSH-HEA           | MOBILE PEDESTAL CUSHION- HEAVENLY | 4 X | \$442           |
| 100-KD28                   | KEYBOARD DRAWER                   | 4 X | \$202           |
| FURNITURE COMPONENT TOTAL= |                                   |     | <b>\$12,190</b> |

**LAYOUT #11  
- 90° RADIAL**

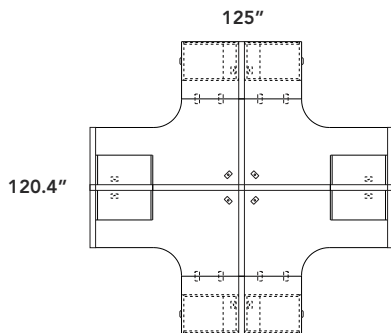
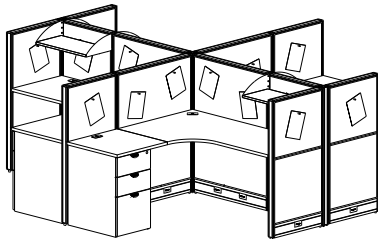

**HDL FRAMEWORK PANEL SYSTEM COMPONENTS**

|                        |                              |     |                |
|------------------------|------------------------------|-----|----------------|
| FRM-3648P              | 48" TALL PANEL               | 4 X | \$490          |
| FRM-2448P              | 48" TALL PANEL               | 8 X | \$360          |
| FRM-48SQP-4W           | SQUARE 4 WAY CONNECTING POST |     | \$118          |
| FRM-48SQP-3W           | SQUARE 3 WAY CONNECTING POST | 2 X | \$104          |
| FRM-48PET              | PANEL END TRIM               | 6 X | \$29           |
| FRM-PCK                | PANEL CONNECTING KIT         | 4 X | \$40           |
| PANEL COMPONENT TOTAL= |                              |     | <b>\$5,500</b> |

**HEARTWOOD COMPONENTS**

|                            |                                    |     |                |
|----------------------------|------------------------------------|-----|----------------|
| FRM-362460RECM             | ROUND EXTENDED CORNER MODULE       | 4 X | \$692          |
| FRM-2424WS                 | WORK SURFACE                       | 4 X | \$196          |
| FRM-OSS24                  | OVERHEAD SHELF                     | 4 X | \$138          |
| FRM-WFBK                   | WORK SURFACE FLUSH BRACKET KIT     | 4 X | \$38           |
| FRM-1624FPUFX              | FREESTANDING BOX/BOX/FILE PEDESTAL | 4 X | \$899          |
| FURNITURE COMPONENT TOTAL= |                                    |     | <b>\$7,852</b> |

ORDER HDL FRAMEWORK PANELS THROUGH HDL.  
FOR DETAILS CHECK ONLINE AT [www.heartwoodDL.com](http://www.heartwoodDL.com) OR REFER TO FRM TAB IN THE HDL PRICER.

**LAYOUT #12  
- 120° RADIAL**

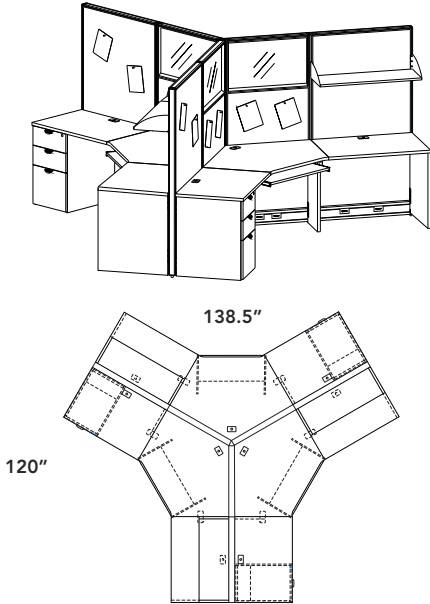

| ITEMS  | ITEM DESCRIPTION               | QTY | LIST           |
|--|--------------------------------|-----|----------------|
| <b>HDL FRAMEWORK PANEL SYSTEM COMPONENTS</b> |                                |     |                |
| FRM-3066GP                                   | 66" TALL CLEAR GLAZED PANEL    | 3 X | \$673          |
| FRM-3666P                                    | 66" TALL PANEL                 | 3 X | \$600          |
| FRM-PCK                                      | PANEL CONNECTING KIT           | 3 X | \$40           |
| FRM-66PET                                    | PANEL END TRIM                 | 3 X | \$32           |
| FRM-66TRP-3W                                 | TRIANGLE 3 WAY CONNECTING POST |     | \$127          |
| PANEL COMPONENT TOTAL=                       |                                |     | <b>\$4,162</b> |

|                             |                                    |     |                |
|-----------------------------|------------------------------------|-----|----------------|
| <b>HEARTWOOD COMPONENTS</b> |                                    |     |                |
| FRM-2430AC120               | 120° ANGLED CORNER                 | 3 X | \$446          |
| FRM-2436WS                  | WORK SURFACE                       | 6 X | \$212          |
| FRM-1624FPUFX               | FREESTANDING BOX/BOX/FILE PEDESTAL | 3 X | \$899          |
| FRM-GF24                    | FULL GABLE                         | 3 X | \$266          |
| FRM-GH24                    | HALF GABLE                         | 6 X | \$257          |
| FRM-OSS36                   | OVERHEAD SHELF                     | 3 X | \$164          |
| 100-KD28                    | KEYBOARD DRAWER                    | 3 X | \$202          |
| FURNITURE COMPONENT TOTAL=  |                                    |     | <b>\$8,745</b> |

**LAYOUT #13  
- 120° RADIAL DOGBONE FEATURING 388 SERIES**

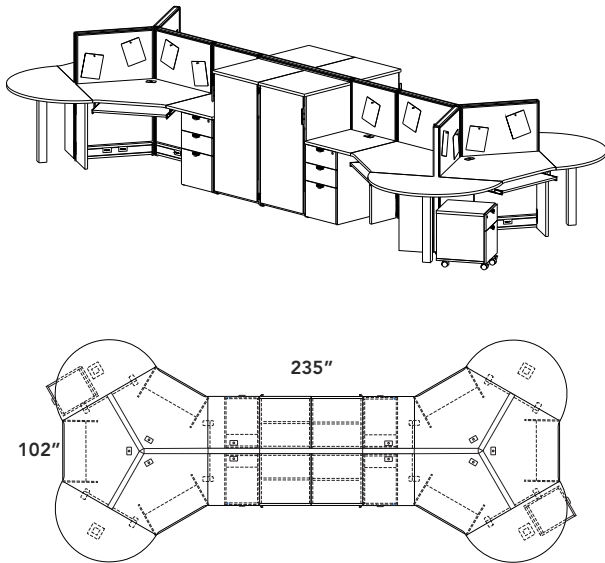

|  |                                |     |                |
|--|--------------------------------|-----|----------------|
| <b>HDL FRAMEWORK PANEL SYSTEM COMPONENTS</b> |                                |     |                |
| FRM-4848P                                    | 48" TALL PANEL                 |     | \$560          |
| FRM-2448P                                    | 48" TALL PANEL                 | 2 X | \$360          |
| FRM-3048P                                    | 48" TALL PANEL                 | 6 X | \$413          |
| FRM-48TRP-3W                                 | TRIANGLE 3 WAY CONNECTING POST | 2 X | \$111          |
| FRM-PCK                                      | PANEL CONNECTING KIT           | 4 X | \$40           |
| FRM-48PET                                    | PANEL END TRIM                 | 4 X | \$29           |
| PANEL COMPONENT TOTAL=                       |                                |     | <b>\$4,256</b> |

|                             |                                    |      |                 |
|-----------------------------|------------------------------------|------|-----------------|
| <b>HEARTWOOD COMPONENTS</b> |                                    |      |                 |
| FRM-2430AC120               | 120° ANGLED CORNER                 | 6 X  | \$446           |
| FRM-2424WS                  | WORK SURFACE                       | 4 X  | \$196           |
| FRM-1624FPUFX               | FREESTANDING BOX/BOX/FILE PEDESTAL | 4 X  | \$899           |
| FRM-2424HM                  | HALF MOON TOP                      | 4 X  | \$445           |
| FRM-GH24                    | HALF GABLE                         | 12 X | \$257           |
| FRM-1622MPF                 | MOBILE BOX/FILE PEDESTAL           | 2 X  | \$794           |
| FRM-MPEDCUSH-HEA            | MOBILE PEDESTAL CUSHION- HEAVENLY  | 2 X  | \$442           |
| 100-KD28                    | KEYBOARD DRAWER                    | 6 X  | \$202           |
| 388-4724MCL24-L             | MID-HEIGHT CLOSET CABINET          | 2 X  | \$1,385         |
| 388-4724MCL24-R             | MID-HEIGHT CLOSET CABINET          | 2 X  | \$1,385         |
| FURNITURE COMPONENT TOTAL=  |                                    |      | <b>\$21,144</b> |

ORDER HDL FRAMEWORK PANELS THROUGH HDL.  
FOR DETAILS CHECK ONLINE AT [www.heartwoodDL.com](http://www.heartwoodDL.com) OR REFER TO FRM TAB IN THE HDL PRICER.

**LAYOUT #14**  
**- WALL MOUNTED LINEAR CUBICLES FEATURING 388 SERIES**

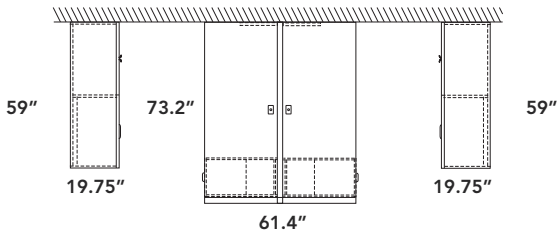
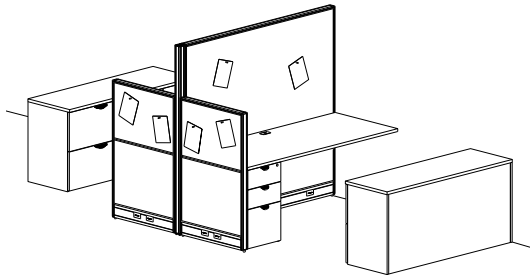

**HDL FRAMEWORK PANEL SYSTEM COMPONENTS**

| ITEMS                  | ITEM DESCRIPTION                                     | QTY | LIST    |
|------------------------|--|-----|---------|
| FRM-7266P              | 66" TALL PANEL                                       |     | \$1105  |
| FRM-3048P              | 48" TALL PANEL                                       | 2 X | \$413   |
| FRM-66SQP-3W           | SQUARE 3 WAY CONNECTING POST                         |     | \$122   |
| FRM-48PET              | PANEL END TRIM                                       | 2 X | \$29    |
| FRM-FWMB               | FLUSH WALL MOUNT BRACKET SET (HIDDEN AFTER INSTALL). |     | \$45    |
| PANEL COMPONENT TOTAL= |  |     | \$2,156 |

**HEARTWOOD COMPONENTS**

|                            |                                    |     |         |
|----------------------------|------------------------------------|-----|---------|
| FRM-3072WS                 | WORK SURFACE                       | 2 X | \$456   |
| FRM-WB15-R                 | WORK SURFACE BRACKETS              |     | \$50    |
| FRM-WB15-L                 | WORK SURFACE BRACKETS              |     | \$50    |
| FRM-1630FPUFX              | FREESTANDING BOX/BOX/FILE PEDESTAL | 2 X | \$944   |
| 388-LF2060C                | 30" LATERAL FILE & 30" CABINET     |     | \$1,920 |
| 388-C2060LF                | 30" CABINET & 30" LATERAL FILE     |     | \$1,920 |
| FURNITURE COMPONENT TOTAL= |                                    |     | \$6,740 |

**LAYOUT #15**  
**- DUAL WORKSTATIONS FEATURING 388 & WORKSPACE SERIES**

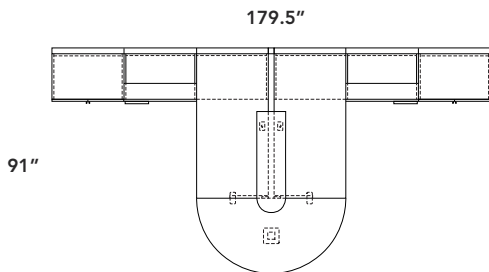
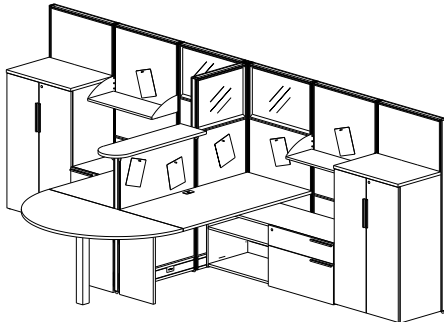

**HDL FRAMEWORK PANEL SYSTEM COMPONENTS**

| ITEMS                  | ITEM DESCRIPTION             | QTY | LIST    |
|------------------------|------------------------------|-----|---------|
| FRM-3066P              | 66" TALL PANEL               | 4 X | \$509   |
| FRM-3066GP             | 66" TALL CLEAR GLAZED PANEL  | 2 X | \$673   |
| FRM-2466GP             | 66" TALL CLEAR GLAZED PANEL  |     | \$607   |
| FRM-3648P              | 48" TALL PANEL               |     | \$490   |
| FRM-66SQP-3W           | SQUARE 3 WAY CONNECTING POST |     | \$122   |
| FRM-66PET              | PANEL END TRIM               | 2 X | \$32    |
| FRM-48PET              | PANEL END TRIM               |     | \$29    |
| FRM-18PET              | PANEL END TRIM               |     | \$20    |
| FRM-PCK                | PANEL CONNECTING KIT         | 5 X | \$40    |
| PANEL COMPONENT TOTAL= |                              |     | \$4,914 |

**HEARTWOOD COMPONENTS**

|                            |   |     |         |
|----------------------------|---|-----|---------|
| FRM-3060WS                 | WORK SURFACE  | 2 X | \$400   |
| FRM-3030HM                 | HALF MOON TOP   |     | \$580   |
| FRM3-1236DTA               | D TRANSACTION TOP                                     |     | \$169   |
| FRM-GH30                   | HALF GABLE  | 2 X | \$257   |
| FRM-OSS30                  | OVERHEAD SHELF  | 2 X | \$149   |
| WRK-WDLF2060CO-21          | 21" HIGH WIDE DRAWER/LATERAL FILE, OPEN SHELF CRENZAS |     | \$1,347 |
| WRK-CO2060WDLF-21          | 21" HIGH OPEN SHELF, WIDE DRAWER/LATERAL FILE CRENZAS |     | \$1,347 |
| 388-4730C-20               | MID HEIGHT CABINET                                    | 2 X | \$1,262 |
| FURNITURE COMPONENT TOTAL= |   |     | \$7,579 |

ORDER HDL FRAMEWORK PANELS THROUGH HDL.  
FOR DETAILS CHECK ONLINE AT [www.heartwoodDL.com](http://www.heartwoodDL.com) OR REFER TO FRM TAB IN THE HDL PRICER.

**LAYOUT #16  
- DUAL WORKSTATIONS FEATURING 388 SERIES**

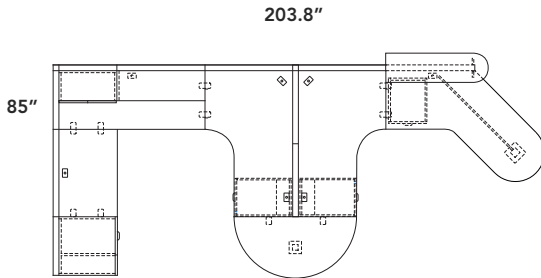
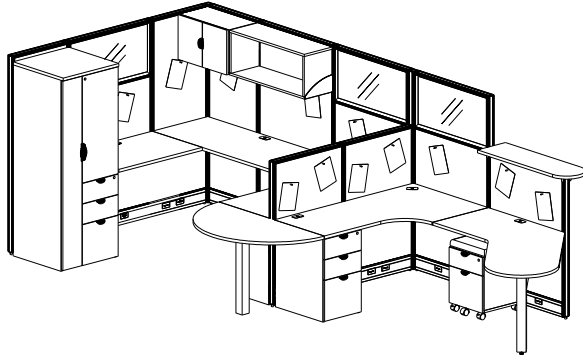

| ITEMS | ITEM DESCRIPTION | QTY | LIST |
|-------|------------------|-----|------|
|-------|------------------|-----|------|

**HDL FRAMEWORK PANEL SYSTEM COMPONENTS**

|                        |                              |     |                |
|------------------------|------------------------------|-----|----------------|
| FRM-2466P              | 66" TALL PANEL               | 3 X | \$457          |
| FRM-3666P              | 66" TALL PANEL               |     | \$600          |
| FRM-3666GP             | 66" TALL CLEAR GLAZED PANEL  | 3 X | \$777          |
| FRM-3048P              | 48" TALL PANEL               | 2 X | \$413          |
| FRM-3648P              | 48" TALL PANEL               |     | \$490          |
| FRM-66SQP-2W           | SQUARE 2 WAY CONNECTING POST |     | \$109          |
| FRM-66SQP-3W           | SQUARE 3 WAY CONNECTING POST |     | \$122          |
| FRM-66PET              | PANEL END TRIM               |     | \$32           |
| FRM-48PET              | PANEL END TRIM               | 2 X | \$29           |
| FRM-18PET              | PANEL END TRIM               |     | \$20           |
| FRM-PCK                | PANEL CONNECTING KIT         | 6 X | \$40           |
| PANEL COMPONENT TOTAL= |                              |     | <b>\$6,199</b> |

**HEARTWOOD COMPONENTS**

|                            |                                    |     |                |
|----------------------------|------------------------------------|-----|----------------|
| FRM-362460RECM             | ROUND EXTENDED CORNER MODULE       | 2 X | \$545          |
| FRM-2436APM-2              | ANGLED PENINSULA TOP               |     | \$671          |
| FRM-2436WS                 | WORK SURFACE                       |     | \$212          |
| FRM-2460WS                 | WORK SURFACE                       |     | \$352          |
| FRM-2424HM                 | HALF MOON TOP                      |     | \$445          |
| FRM-1524OSHD               | OVERHEAD STORAGE W/ HINGED DOORS   |     | \$725          |
| FRM-1536OSO                | OPEN OVERHEAD STORAGE              |     | \$502          |
| FRM-1624FPFFX              | FREESTANDING FILE/FILE PEDESTAL    |     | \$899          |
| FRM-1624FPUFX              | FREESTANDING BOX/BOX/FILE PEDESTAL |     | \$899          |
| FRM-1622MPF                | MOBILE BOX/FILE PEDESTAL           |     | \$794          |
| FRM-MPEDCUSH-HEA           | MOBILE PEDESTAL CUSHION- HEAVENLY  |     | \$442          |
| FRM3-1236DTA               | D TRANSACTION TOP                  |     | \$169          |
| 388-6524CUFWL-24           | PERSONAL WARDROBE STORAGE          |     | \$2,281        |
| FRM-WFBK                   | WORK SURFACE FLUSH BRACKET KIT     | 3 X | \$38           |
| FRM-WABK                   | WORK SURFACE ANGLE BRACKET KIT     | 2 X | \$42           |
| FURNITURE COMPONENT TOTAL= |                                    |     | <b>\$9,973</b> |

ORDER HDL FRAMEWORK PANELS THROUGH HDL.  
FOR DETAILS CHECK ONLINE AT [www.heartwoodDL.com](http://www.heartwoodDL.com) OR REFER TO FRM TAB IN THE HDL PRICER.

**LAYOUT #17**  
**- CUBICLE FEATURING 388 & OUTLINES SERIES**

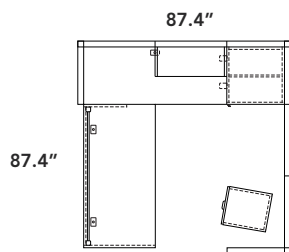
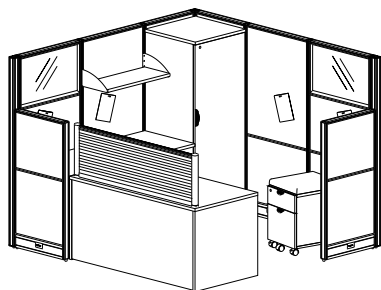

| ITEMS | ITEM DESCRIPTION | QTY | LIST |
|-------|------------------|-----|------|
|-------|------------------|-----|------|

**HDL FRAMEWORK PANEL SYSTEM COMPONENTS**

|                        |                              |     |                |
|------------------------|------------------------------|-----|----------------|
| FRM-2448P              | 48" TALL PANEL               | 2 X | \$360          |
| FRM-3066GP             | 66" TALL CLEAR GLAZED PANEL  | 2 X | \$673          |
| FRM-3066P              | 66" TALL PANEL               | 2 X | \$509          |
| FRM-2466P              | 66" TALL PANEL               | 2 X | \$457          |
| FRM-66SQP-2W           | SQUARE 2 WAY CONNECTING POST | 3 X | \$109          |
| FRM-48PET              | PANEL END TRIM               | 2 X | \$29           |
| FRM-PCK                | PANEL CONNECTING KIT         | 4 X | \$40           |
| PANEL COMPONENT TOTAL= |                              |     | <b>\$4,543</b> |

**HEARTWOOD COMPONENTS**

|                            |                                   |     |                |
|----------------------------|-----------------------------------|-----|----------------|
| FRM-2460WS                 | WORK SURFACE                      |     | \$352          |
| FRM-OSS30                  | OVERHEAD SHELF                    |     | \$149          |
| FRM-1622MPF                | MOBILE BOX/FILE PEDESTAL          |     | \$794          |
| FRM-MPEDCUSH-HEA           | MOBILE PEDESTAL CUSHION- HEAVENLY |     | \$442          |
| FRM-WABK                   | WORK SURFACE ANGLE BRACKET KIT    |     | \$42           |
| FRM-WFBK                   | WORK SURFACE FLUSH BRACKET KIT    |     | \$38           |
| 388-6524CLC-R-24           | SINGLE DOOR CLOSET CABINET        |     | \$1,862        |
| 388-3060CT-B               | 30" CONNECTOR TOP - B GABLES      |     | \$803          |
| OUT-18POST                 | POST PACKAGES                     | 2 X | \$113          |
| OUT-1860PYP                | 18" POLYCARBONATE PANELS          |     | \$516          |
| FURNITURE COMPONENT TOTAL= |                                   |     | <b>\$5,224</b> |

**LAYOUT #18**  
**- LINEAR BENCHING LAYOUT FEATURING OUTLINES SERIES**

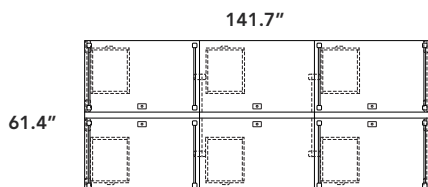
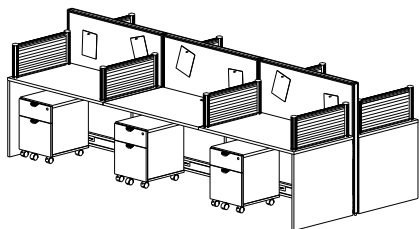

**HDL FRAMEWORK PANEL SYSTEM COMPONENTS**

|                        |                      |     |                |
|------------------------|----------------------|-----|----------------|
| FRM-4848P              | 48" TALL PANEL       | 3 X | \$560          |
| FRM-48PET              | PANEL END TRIM       | 2 X | \$29           |
| FRM-PCK                | PANEL CONNECTING KIT | 2 X | \$40           |
| PANEL COMPONENT TOTAL= |                      |     | <b>\$1,818</b> |

**HEARTWOOD COMPONENTS**

|                            |                          |      |                 |
|----------------------------|--------------------------|------|-----------------|
| FRM-3048WS                 | WORK SURFACE             | 6 X  | \$298           |
| FRM-GF30                   | FULL GABLE               | 4 X  | \$285           |
| FRM-GH30                   | HALF GABLE               | 4 X  | \$257           |
| FRM-1622MPF                | MOBILE BOX/FILE PEDESTAL | 6 X  | \$794           |
| OUT-1230PYP                | 12" POLYCARBONATE PANELS | 8 X  | \$240           |
| OUT-12POST                 | OUTLINES POST PACKAGE    | 16 X | \$94            |
| FURNITURE COMPONENT TOTAL= |                          |      | <b>\$12,144</b> |

ORDER HDL FRAMEWORK PANELS THROUGH HDL.  
FOR DETAILS CHECK ONLINE AT [www.heartwoodDL.com](http://www.heartwoodDL.com) OR REFER TO FRM TAB IN THE HDL PRICER.

|   | ITEMS  | ITEM DESCRIPTION                                     | QTY | LIST  |
|---|--|--|-----|-------|
| <b>LAYOUT #19</b><br><b>- LINEAR WALL MOUNTED QUAD FEATURING CEILING FEED</b> | <b>HDL FRAMEWORK PANEL SYSTEM COMPONENTS</b> |  |     |       |
|   | FRM-2466GP                                   | 66" TALL CLEAR GLAZED PANEL                          | 4 X | \$607 |
|   | FRM-2466P                                    | 66" TALL PANEL                                       | 2 X | \$457 |
|   | FRM-3066P                                    | 66" TALL PANEL                                       | 2 X | \$509 |
|   | FRM-PCK                                      | PANEL CONNECTING KIT                                 | 4 X | \$40  |
|   | FRM-66PET                                    | PANEL END TRIM                                       | 3 X | \$32  |
|   | FRM-66SQP-4W                                 | SQUARE 4 WAY CONNECTING POST                         |     | \$133 |
|   | FRM-CLG-FD1                                  | CEILING FEED SET                                     |     | \$232 |
|   | FRM-FWMB                                     | FLUSH WALL MOUNT BRACKET SET (HIDDEN AFTER INSTALL). |     | \$45  |
|   |  | PANEL COMPONENT TOTAL=                               |     |       |

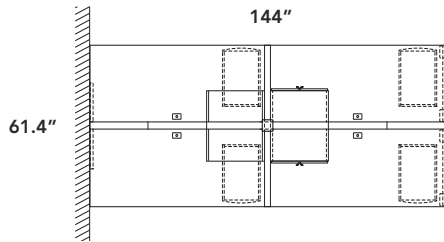
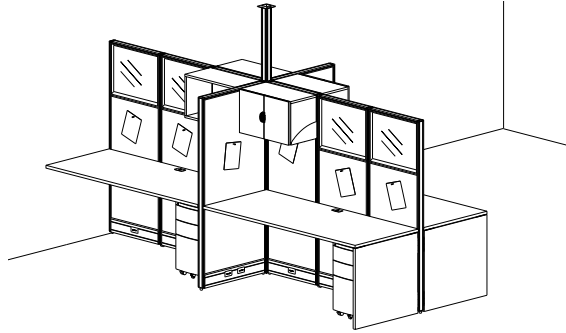

**NOTE:** PRICE DOES NOT INCLUDE ELECTRICAL COMPONENTS TO POWER WORKSTATIONS. REFER TO HDL PRICEBOOK PAGES FRM-5 TO **FRM-8** FOR COMPLETE POWER OPTIONS AND PRICING.

|                             |                                     |     |       |                |
|-----------------------------|-------------------------------------|-----|-------|----------------|
| <b>HEARTWOOD COMPONENTS</b> |                                     |     |       |                |
| FRM-3072WS                  | WORK SURFACE                        | 4 X | \$456 |                |
| FRM-1524OSO                 | OPEN OVERHEAD STORAGE               | 2 X | \$457 |                |
| FRM-1524OSHD                | OVERHEAD STORAGE W/ HINGED DOORS    | 2 X | \$725 |                |
| FRM-WB15-R                  | WORK SURFACE BRACKETS               |     | \$50  |                |
| FRM-WB15-L                  | WORK SURFACE BRACKETS               |     | \$50  |                |
| FRM-GF30                    | FULL GABLE                          | 2 X | \$285 |                |
| 100-MMPUF                   | METAL MOBILE PEDESTAL - FULL CARTON | 4 X | \$540 |                |
|                             | FURNITURE COMPONENT TOTAL=          |     |       | <b>\$7,018</b> |

**LAYOUT #20**  
**- BASIC LAYOUT FEATURING 388 SERIES AND CEILING FEED**

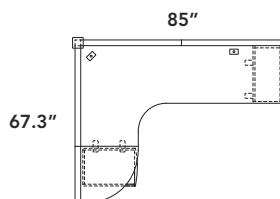
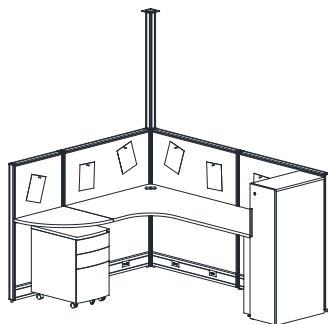

|  |                                     |     |       |                |
|--|-------------------------------------|-----|-------|----------------|
| <b>HDL FRAMEWORK PANEL SYSTEM COMPONENTS</b> |                                     |     |       |                |
| FRM-4248P                                    | 48" TALL PANEL                      | 3 X | \$525 |                |
| FRM-2448P                                    | 48" TALL PANEL                      |     | \$360 |                |
| FRM-PCK                                      | PANEL CONNECTING KIT                | 2 X | \$40  |                |
| FRM-48SQP-2W                                 | SQUARE 2 WAY CONNECTING POST        |     | \$90  |                |
| FRM-48PET                                    | PANEL END TRIM                      | 2 X | \$29  |                |
| FRM-CLG-FD1                                  | CEILING FEED SET                    |     | \$232 |                |
|  | PANEL COMPONENT TOTAL=              |     |       | <b>\$2,395</b> |
| <b>HEARTWOOD COMPONENTS</b>                  |                                     |     |       |                |
| FRM-422472RECM                               | EXTENDED CORNER MODULE              |     | \$740 |                |
| FRM-2424QR                                   | QUARTER ROUND TOP                   |     | \$199 |                |
| FRM-WFBK                                     | WORK SURFACE FLUSH BRACKET KIT      |     | \$38  |                |
| FRM-WABK                                     | WORK SURFACE ANGLE BRACKET KIT      |     | \$42  |                |
| 100-MMPUF                                    | METAL MOBILE PEDESTAL - FULL CARTON |     | \$540 |                |
| 388-4712MCL24-R                              | MID-HIGHT CLOSET CABINET            |     | \$989 |                |
|  | FURNITURE COMPONENT TOTAL=          |     |       | <b>\$2,548</b> |

**NOTE:** PRICE DOES NOT INCLUDE ELECTRICAL COMPONENTS TO POWER WORKSTATIONS. REFER TO HDL PRICEBOOK PAGES **FRM-5** TO FRM-8 FOR COMPLETE POWER OPTIONS AND PRICING.

ORDER HDL FRAMEWORK PANELS THROUGH HDL.  
FOR DETAILS CHECK ONLINE AT [www.heartwoodDL.com](http://www.heartwoodDL.com) OR REFER TO FRM TAB IN THE HDL PRICER.

|                   | ITEMS  | ITEM DESCRIPTION               | QTY                          | LIST            |                 |
|-------------------|--|--------------------------------|------------------------------|-----------------|-----------------|
| <b>LAYOUT #21</b> | <b>HDL FRAMEWORK PANEL SYSTEM COMPONENTS</b> |                                |                              |                 |                 |
|                   |  | FRM-4848P                      | 48" TALL PANEL               | 4 X             | \$560           |
|                   |  | FRM-4248P                      | 48" TALL PANEL               | 5 X             | \$525           |
|                   |  | FRM-3648P                      | 48" TALL PANEL               | 8 X             | \$490           |
|                   |  | FRM-48SQP-2W                   | SQUARE 2 WAY CONNECTING POST | 2 X             | \$90            |
|                   |  | FRM-48SQP-3W                   | SQUARE 3 WAY CONNECTING POST | 3 X             | \$104           |
|                   |  | FRM-48SQP-4W                   | SQUARE 4 WAY CONNECTING POST | 1 X             | \$118           |
|                   |  | FRM-48PET                      | PANEL END TRIM               | 9 X             | \$29            |
|                   |  | FRM-1036PLX                    | PLEXIGLASS PANEL EXTENSION   | 8 X             | \$159           |
|                   |  | FRM-PCK                        | PANEL CONNECTING KIT         | 4 X             | \$40            |
|                   |  |                                | PANEL COMPONENT TOTAL=       |                 | <b>\$11,088</b> |
|                   |  | <b>HEARTWOOD COMPONENTS</b>    |                              |                 |                 |
|                   |  | FRM-2448WS                     | 48" WORK SURFACE             | 4 X             | \$244           |
|                   |  | FRM-362472ECM                  | EXTENDED CORNER MODULE       | 4 X             | \$692           |
|                   |  | FRM-2436WS                     | 36" WORK SURFACE             | 4 X             | \$212           |
|                   | 900-LOOP24                                   | 24" METAL LOOP LEG             | 8 X                          | \$188           |                 |
|                   | 100-KD28                                     | KEYBOARD DRAWER                | 4 X                          | \$202           |                 |
|                   | 100-AKTM-2                                   | ARTICULATING KEYBOARD TRAY     | 4 X                          | \$275           |                 |
|                   | FRM-WFBK                                     | WORK SURFACE FLUSH BRACKET KIT | 4 X                          | \$38            |                 |
|                   | 388-6518CLC-L-24                             | SINGLE DOOR CLOSET CABINET     | 2 X                          | \$1,862         |                 |
|                   | FRM-1622MPF                                  | MOBILE BOX/FILE PEDESTAL       | 4 X                          | \$794           |                 |
|                   | FRM-MPEDCUSH-ESC                             | MOBILE PEDESTAL CUSHION        | 4 X                          | \$409           |                 |
|                   |  | FURNITURE COMPONENT TOTAL=     |                              | <b>\$16,692</b> |                 |

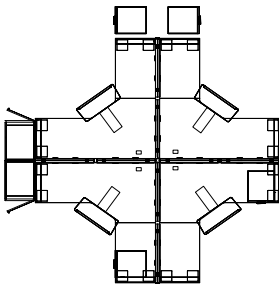
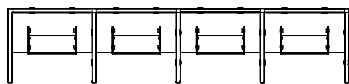
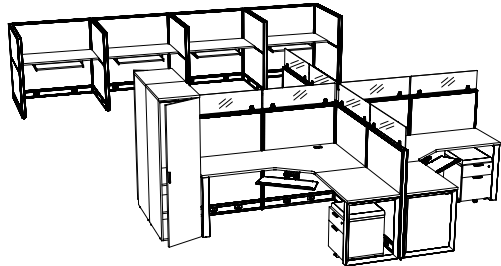



# FLEX SERIES

This is a metric series (imperial sizing available). Please refer to page [INDEX-1](#) for details

|  |                        |
|--|------------------------|
| <b>Series Specifications &amp; Description</b> ..... | <a href="#">FLX-2</a>  |
| <b>Product by Category</b> .....                     |                        |
| <b>Bases</b> .....                                   |                        |
| 900 Series Metal Table Bases & Legs .....            | <a href="#">FLX-3</a>  |
| TUCANA Series Table Bases .....                      | <a href="#">FLX-6</a>  |
| TUCANA Elite Series Table Bases .....                | <a href="#">FLX-7</a>  |
| <b>Laminate Table Top &amp; Base Chart</b> .....     | <a href="#">FLX-8</a>  |
| <b>Table Tops</b> .....                              |                        |
| Rectangle Tops .....                                 | <a href="#">FLX-10</a> |
| Rectangle Scooped Tops .....                         | <a href="#">FLX-11</a> |
| Rectangle Bowed Tops .....                           | <a href="#">FLX-12</a> |
| Wave Tops .....                                      | <a href="#">FLX-13</a> |
| Square Tops .....                                    | <a href="#">FLX-14</a> |
| Round Tops .....                                     | <a href="#">FLX-14</a> |
| Trapezoid Tops .....                                 | <a href="#">FLX-14</a> |
| Shaped Tops .....                                    | <a href="#">FLX-14</a> |
| Connecting Tops .....                                | <a href="#">FLX-15</a> |
| <b>Modesty Panels</b> .....                          | <a href="#">FLX-16</a> |
| <b>Sample Table Layouts</b> .....                    |                        |
| 900 Series Bases .....                               | <a href="#">FLX-17</a> |
| Tucana Bases .....                                   | <a href="#">FLX-19</a> |
| Tucana Elite Bases .....                             | <a href="#">FLX-20</a> |
| 900 Series Bases .....                               | <a href="#">FLX-21</a> |

**Features**

- ♥ Flexibility, style, function and...durability.
- ♥ Quick install.
- ♥ Tops are pre-drilled with installed insert nuts for base assembly, certain restrictions apply.
- ♥ Optional wire management channels.
- ♥ Leveling glides.
- ♥ Metal legs convert easily to mobile with optional casters.
- ♥ Optional radius corners on work surfaces.

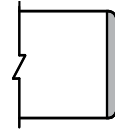

Matching 2mm edge band on all exposed edges

**Finishes**

| Laminate |                    | DEFAULT FINISHES |               |                 |
|----------|--------------------|------------------|---------------|-----------------|
|          |                    | TOPS             | MATCHING EDGE | GROMMET (BLACK) |
| AM       | Autumn Maple       | ✓                | ✓             | ✓               |
| BW       | Black Walnut       | ✓                | ✓             | ✓               |
| CD       | Cappuccino Dream** | ✓                | ✓             | ✓               |
| CM       | Charcoal Matrix    | ✓                | Black         | ✓               |
| DE       | Desert Sand        | ✓                | ✓             | ✓               |
| DD       | Driftwood***       | ✓                | ✓             | ✓               |
| DW       | Driftwood Grey**   | (n/a)            | (n/a)         | (n/a)           |
| EZ       | Evening Zen        | ✓                | ✓             | ✓               |
| GA       | Golden Ash         | ✓                | ✓             | ✓               |
| GD       | Grey Dusk          | ✓                | ✓             | ✓               |
| GM       | Grey Matrix        | ✓                | Grey          | ✓               |
| GR       | Grey               | ✓                | ✓             | ✓               |
| HM       | Hardrock Maple     | ✓                | ✓             | ✓               |
| NC       | Noce Coca          | ✓                | ✓             | Grey            |
| PW       | Pure White         | ✓                | ✓             | Grey            |
| RM       | Royal Mahogany     | ✓                | ✓             | ✓               |
| SM       | Sugar Maple        | ✓                | ✓             | ✓               |
| SW       | Seaside White      | ✓                | ✓             | Grey            |
| VA       | Volcanic Ash       | ✓                | ✓             | ✓               |
| WW       | Winter Wood        | ✓                | ✓             | Grey            |
| WB       | White Board*       | ✓                | ♦             | ✓               |

\*\* Textured Finish  
\*\*\* 1" & 1½" Non-textured material only  
♦ WB is ¾" laminate material. Matching 2mm band is not recommended as it may discolour - order BL or GT  
Drilling for Insert nut leg connection is standard for WB, ¾" laminate material.  
**High Pressure (HP) laminate available**  
**Contact Customer Service.**

**Construction**

- ♥ All table tops and modesty panels are constructed of thermally fused laminate.
- ♥ Default tops are 1" thick and have square corners, use FLXS sku and price. For 1½" radius corners remove the "S" and use the FLX price.

**Ordering Example:** Square Corners - **FLXS-REC3036**  
1½" Radius Corners - **FLX-REC3036**

**FLXS**  
(default)

**FLX**

- ♥ Optional modesty panels are ¾" thick and have square corners.
- ♥ Tops are not pre-drilled unless a base is specified and/or ordered on same purchase order (PO). The only exceptions are height adjustable bases and metal LOOP legs, tops will not be pre-drilled.
- ♥ Tops **1½" thick** are available, contact Customer Service for pricing. use "**FLXS2**" or "**FLX2**" when ordering.
- ♥ To GANG/connect tops together with hardware, HML will drill for end to end connection only on the depth end. If you require ganging on the long /width sides, a **\$83** list upcharge applies and add a 'C' in front of the SKU with this description, add 'custom side to side ganging'. Of note, ganging hardware is included with regular Tucana bases only in the carton (SKU: TU-97L) , all other base applications you must add either FLX-TGH (for Tucana ganging hardware) or TU-98B-TGH (for Tucana ELITE hardware).

**Accessories**

- ♥ Factory installed 2" x 3" Grommet (**\$46** each list) available for FLEX series tops. Location of grommet/s must be specified with order.
- ♥ The 100 Series now has expanded options for power and data management. See the new power grommet available in 100 Series page **100-6**.

**Example:** Flip Top Power Grommets with Data: 100-FTP-DATA  
Flip Top Power Grommets with USB: 100-FTP-USB

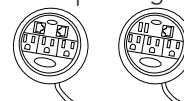

- ♥ Monitor arms are available in Black (BL) and Silver (SL) finish and can be both grommet mounted or clamp mounted.  
See 100-9  
Single mount : 100-MA1 or 100-MA1B  
Dual mount: 100-MA2 or 100-MA2B

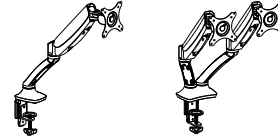

**Edge Detail**

- ♥ FLEX series table tops are edged with matching 2mm edge band for durability.
- ♥ FLEX series modesty panels are 3/4" thick and edged with a matching 2mm edge band on 4 sides for durability.
- ♥ Banding changes to an alternate Heartwood standard colour are available at no extra charge.

**Custom Sizes**

- ♥ Custom sizes available...contact Customer Service for pricing - please specify quote number when ordering. For simple width changes, use the price of the next model size up.

**Ordering Example:** For **FLX-RECB3646** use **FLX-RECB3648** list price = \$636

**Shipping**

- ♥ Table tops and modesty panels ordered separately and shipped in separate cartons

**NOTE:** Information is current at time of print. For up to date information check online at [www.heartwood.ca](http://www.heartwood.ca).

**FLEX BASES**









**900 SERIES METAL TABLE BASES & LEGS**

|  | MODEL   | LIST         | WEIGHT<br>LBS | H<br>IN   |
|--|---|--------------|---------------|-----------|
|  | <b>SPIDER LEG</b>   |              |               |           |
|  | 1 PER CARTON. INCLUDES LEVELERS. EASILY CONVERTS TO MOBILE W/ OPTIONAL CASTERS (900-50CASTER).          |              |               |           |
|  | <b>900-SPIDERLEG</b>  | <b>\$103</b> | <b>6.8</b>    | <b>28</b> |
|  | <b>AVAILABLE FINISH:</b> SILVER (SL)  |              |               |           |
|  | <b>STRAIGHT TAPERED LEG</b>   |              |               |           |
|  | 1 PER CARTON. INCLUDES LEVELERS. EASILY CONVERTS TO MOBILE W/ OPTIONAL CASTERS (900-50CASTER).          |              |               |           |
|  | <b>900-TAPERLEG</b>   | <b>\$96</b>  | <b>6</b>      | <b>28</b> |
|  | <b>AVAILABLE FINISH:</b> SILVER (SL)  |              |               |           |
|  | <b>OPTIONAL CASTERS</b>   |              |               |           |
|  | 2 PER CARTON. 50MM DIAMETER WHEEL. LOCKING BLACK WHEEL. EASILY INTER-CHANGEABLE WITH LEVELERS.M8 THREAD |              |               |           |
|  | <b>900-50CASTER</b>   | <b>\$32</b>  | <b>.4</b>     |           |
|  | <b>2 1/2" ROUND LEG</b>   |              |               |           |
|  | 1 PER CARTON. INCLUDES LEVELER. OPTIONAL CASTER NOT AVAILABLE.  |              |               |           |
|  | <b>900-RL2.5</b>  | <b>\$96</b>  | <b>7.2</b>    | <b>28</b> |
|  | <b>AVAILABLE FINISHES:</b> BLACK (BL) & SILVER (SL)   |              |               |           |
|  | <b>3" SQUARE LEG</b>  |              |               |           |
|  | 1 PER CARTON. INCLUDES LEVELER. OPTIONAL CASTER NOT AVAILABLE.  |              |               |           |
|  | <b>900-SQ3</b>  | <b>\$151</b> | <b>9.46</b>   | <b>28</b> |
|  | <b>AVAILABLE FINISHES:</b> BLACK (BL), SILVER (SL) & WHITE (WH)   |              |               |           |

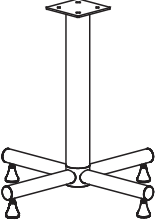
# FLEX BASES

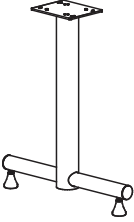
## 900 SERIES METAL TABLE BASES & LEGS

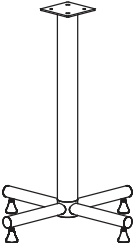
PLEASE REFER TO PAGE [FLX-8](#) - [FLX-9](#), 'FLEX SERIES LAMINATE TABLE TOP & BASE CHART' FOR RECOMMENDED TOP & BASE COMBINATIONS.

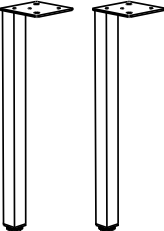
|  |   | MODEL  | LIST               | WEIGHT       | H            |           |
|--|---|--|--------------------|--------------|--------------|-----------|
|  |   |  |                    | LBS          | IN           |           |
|  |   | <b>CROSS BASE</b>  |                    |              |              |           |
|  |   | 1 PER CARTON. INCLUDES LEVELERS. EASILY CONVERTS TO MOBILE W/ OPTIONAL CASTERS (900-50CASTER).   |                    |              |              |           |
|  <p>SHARED LEG</p>   |  <p>MOBILE OPTION</p>   |   | <b>900-CROSS24</b> | <b>\$247</b> | <b>17.60</b> | <b>28</b> |
|  |   |  | <b>900-CROSS30</b> | <b>\$263</b> | <b>19.80</b> | <b>28</b> |
|  |   | AVAILABLE FINISHES: BLACK (BL) & SILVER (SL)   |                    |              |              |           |
|  |   | <b>900-CROSS36</b>   | <b>\$281</b>       | <b>22.10</b> | <b>28</b>    |           |
|  |   | AVAILABLE FINISH: BLACK (BL)   |                    |              |              |           |
|  |   | <b>NOTE:</b> CONTACT CUSTOMER SERVICE FOR CUSTOM HEIGHT BASE PRICING.  |                    |              |              |           |
|  |   | <b>TEE BASE</b>  |                    |              |              |           |
|  |   | 1 PER CARTON. INCLUDES LEVELERS. EASILY CONVERTS TO MOBILE W/ OPTIONAL CASTERS (900-50CASTER).   |                    |              |              |           |
|  <p>SHARED LEG</p>   |  <p>MOBILE OPTION</p>   |   | <b>900-TEE24</b>   | <b>\$158</b> | <b>13</b>    | <b>28</b> |
|  |   |  | <b>900-TEE30</b>   | <b>\$164</b> | <b>14</b>    | <b>28</b> |
|  |   | AVAILABLE FINISHES: BLACK (BL), SILVER (SL) & WHITE (WH)   |                    |              |              |           |
|  |   | <b>900-TEE36</b>   | <b>\$183</b>       | <b>14</b>    | <b>28</b>    |           |
|  |   | AVAILABLE FINISHES: BLACK (BL)   |                    |              |              |           |
|  |   | <b>BAR HEIGHT CROSS BASE</b>   |                    |              |              |           |
|  <p>SHARED LEG</p> |  <p>MOBILE OPTION</p> |   | <b>900-BAR24</b>   | <b>\$312</b> | <b>24</b>    | <b>41</b> |
|  |   |  | <b>900-BAR30</b>   | <b>\$326</b> | <b>30</b>    | <b>41</b> |
|  |   | AVAILABLE FINISHES: BLACK (BL), SILVER (SL) & WHITE (WH)   |                    |              |              |           |
|  |   | <b>900-BAR36</b>   | <b>\$348</b>       | <b>36</b>    | <b>41</b>    |           |
|  |   | <ul style="list-style-type: none"> <li>2 CARTONS (RECYCLE 28" POST - REPLACE W/ 41" POST). INCLUDES LEVELERS. EASILY CONVERTS TO MOBILE W/ OPTIONAL CASTERS (900-50CASTER).</li> </ul> |                    |              |              |           |
|  |   | AVAILABLE FINISH: BLACK (BL)   |                    |              |              |           |
|  |   | <b>METAL LOOP LEGS</b>   |                    |              |              |           |
|  |   | <b>900-LOOP24</b>  | <b>\$188</b>       | <b>23.5</b>  | <b>28</b>    |           |
|  |   | <b>USE W/ 24" TOP OR WORK SURFACE</b>  |                    |              |              |           |
|  |   | <b>900-LOOP30</b>  | <b>\$207</b>       | <b>29.5</b>  | <b>28</b>    |           |
|  |   | <b>USE W/ 30" TOP OR WORK SURFACE</b>  |                    |              |              |           |
|  |   | <ul style="list-style-type: none"> <li>1 PER CARTON. INCLUDES LEVELER.</li> <li>OPTIONAL CASTER NOT AVAILABLE.</li> </ul>  |                    |              |              |           |
|  |   | AVAILABLE FINISHES: BLACK (BL), SILVER (SL) & WHITE (WH)   |                    |              |              |           |
|  |   | <b>2" SQUARE POST LEG WITH OFFSET TOP PLATE</b>  |                    |              |              |           |
|  |   | SOLD IN QTY 2  |                    |              |              |           |
|  <p>SHARED LEG</p> |                      | <b>900-SQ2OFFSET</b>   | <b>\$194</b>       | <b>23.5</b>  | <b>28</b>    |           |
|  |   | AVAILABLE FINISHES: BLACK (BL), SILVER (SL) & WHITE (WH)   |                    |              |              |           |

PLEASE REFER TO PAGE **FLX-8 - FLX-9**, 'FLEX SERIES LAMINATE TABLE TOP & BASE CHART' FOR RECOMMENDED TOP & BASE COMBINATIONS.

| MODEL | LIST | WEIGHT | CUBE            | W  | D  | H  |
|-------|------|--------|-----------------|----|----|----|
|       |      | LBS    | FT <sup>3</sup> | IN | IN | IN |

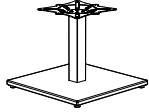
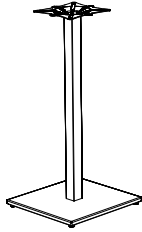
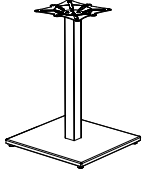

**SQUARE METAL BASE**

|                  |              |             |            |              |              |           |
|------------------|--------------|-------------|------------|--------------|--------------|-----------|
| <b>900-SQB20</b> | <b>\$474</b> | <b>36.5</b> | <b>0.7</b> | <b>19.75</b> | <b>19.75</b> | <b>28</b> |
|------------------|--------------|-------------|------------|--------------|--------------|-----------|

- INCLUDES LEVELERS.

**AVAILABLE FINISHES:** BLACK (BL), WHITE (WH) & SILVER (SL)

**BAR HEIGHT SQUARE METAL BASE**

|                     |              |             |            |              |              |           |
|---------------------|--------------|-------------|------------|--------------|--------------|-----------|
| <b>900-SQB20BAR</b> | <b>\$538</b> | <b>40.3</b> | <b>0.8</b> | <b>19.75</b> | <b>19.75</b> | <b>41</b> |
|---------------------|--------------|-------------|------------|--------------|--------------|-----------|

- INCLUDES LEVELERS. SHIPS IN 2 CARTONS.

**AVAILABLE FINISHES:** BLACK (BL), WHITE (WH) & SILVER (SL)

**COFFEE TABLE HEIGHT SQUARE METAL BASE**

|                     |              |             |            |              |              |              |
|---------------------|--------------|-------------|------------|--------------|--------------|--------------|
| <b>900-SQB20CFT</b> | <b>\$474</b> | <b>35.5</b> | <b>0.6</b> | <b>19.75</b> | <b>19.75</b> | <b>15.75</b> |
|---------------------|--------------|-------------|------------|--------------|--------------|--------------|

- SHIPS IN 2 CARTONS.

**AVAILABLE FINISHES:** BLACK (BL) & SILVER (SL)

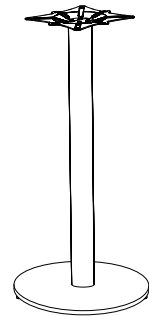
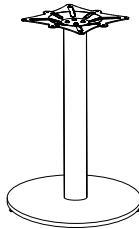
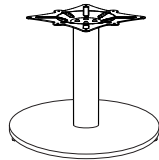

**COFFEE TABLE HEIGHT ROUND METAL BASE**

|                     |              |             |            |              |              |              |
|---------------------|--------------|-------------|------------|--------------|--------------|--------------|
| <b>900-ROU20CFT</b> | <b>\$474</b> | <b>35.5</b> | <b>0.6</b> | <b>23.75</b> | <b>23.75</b> | <b>15.75</b> |
|---------------------|--------------|-------------|------------|--------------|--------------|--------------|

- INCLUDES LEVELERS. SHIPS IN 2 CARTONS.

**AVAILABLE FINISHES:** BLACK (BL) & SILVER (SL)

**ROUND METAL BASE**

|                  |              |             |            |              |              |           |
|------------------|--------------|-------------|------------|--------------|--------------|-----------|
| <b>900-ROU20</b> | <b>\$474</b> | <b>36.5</b> | <b>0.7</b> | <b>23.75</b> | <b>23.75</b> | <b>28</b> |
|------------------|--------------|-------------|------------|--------------|--------------|-----------|

- INCLUDES LEVELERS. SHIPS IN 2 CARTONS.

**AVAILABLE FINISHES:** BLACK (BL), WHITE (WH) & SILVER (SL)

**BAR HEIGHT ROUND METAL BASE**

|                     |              |             |            |              |              |           |
|---------------------|--------------|-------------|------------|--------------|--------------|-----------|
| <b>900-ROU20BAR</b> | <b>\$538</b> | <b>40.3</b> | <b>0.8</b> | <b>23.75</b> | <b>23.75</b> | <b>41</b> |
|---------------------|--------------|-------------|------------|--------------|--------------|-----------|

- INCLUDES LEVELERS. SHIPS IN 2 CARTONS.

**AVAILABLE FINISHES:** BLACK (BL), WHITE (WH) & SILVER (SL)

# FLEX BASES

## TUCANA SERIES TABLE BASES

PLEASE REFER TO PAGE [FLX-8](#) - [FLX-9](#), 'FLEX SERIES LAMINATE TABLE TOP & BASE CHART' FOR RECOMMENDED TOP & BASE COMBINATIONS.

| MODEL | LIST | WEIGHT | CUBE            | W  | D  | H  |
|-------|------|--------|-----------------|----|----|----|
|       |      | LBS    | FT <sup>3</sup> | IN | IN | IN |

### TRAINING TABLE BASE

|             |       |    |     |    |    |      |
|-------------|-------|----|-----|----|----|------|
| TU-97L-1520 | \$218 | 20 | 1.9 | 15 | 20 | 28.8 |
|-------------|-------|----|-----|----|----|------|

### TRAINING TABLE BASE

|             |       |    |     |      |    |      |
|-------------|-------|----|-----|------|----|------|
| TU-97L-2420 | \$286 | 24 | 2.9 | 24.5 | 20 | 28.8 |
|-------------|-------|----|-----|------|----|------|

### TRAINING TABLE BASE

|             |       |    |     |      |    |      |
|-------------|-------|----|-----|------|----|------|
| TU-97L-5420 | \$351 | 26 | 4.2 | 39.5 | 20 | 28.8 |
|-------------|-------|----|-----|------|----|------|

- RECOMMENDED FOR 1 PERSON PER BASE

### TRAINING TABLE BASE

|             |       |    |     |    |    |      |
|-------------|-------|----|-----|----|----|------|
| TU-97L-7220 | \$453 | 35 | 5.7 | 58 | 20 | 28.8 |
|-------------|-------|----|-----|----|----|------|

- RECOMMENDED FOR 2 PEOPLE PER BASE

### TRAINING TABLE BASE FEATURES:

- METAL WITH SILVER POWDER COAT
- LOCKING CASTERS
- FLIP TOP
- WIRE MANAGEMENT TROUGH
- PERFORATED MODESTY PANEL
- MAXIMUM TOP DEPTH 30

AVAILABLE FINISH: GREY (GR) METALIC

### CPU HOLDER

|             |       |    |     |
|-------------|-------|----|-----|
| TU-97C-0813 | \$127 | 10 | 1.5 |
|-------------|-------|----|-----|

### TABLE GANGING HARDWARE

|         |      |   |     |
|---------|------|---|-----|
| FLX-TGH | \$33 | 1 | 0.1 |
|---------|------|---|-----|

- INCLUDED W/ TUCANA BASES. REQUIRED WHEN GANGING BASES OTHER THAN TUCANA.
- FOR FAST LAYOUT RECONFIGURATION
- 2 REQUIRED PER TABLE CONNECTION
- PRICE PER PAIR

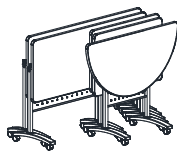
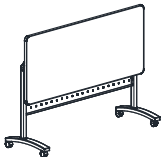
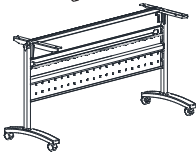
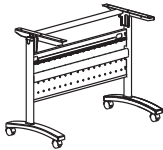
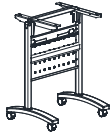

EXAMPLE 1: 60" TRAINING TABLE WITH BASE IN FOLD DOWN POSITION.

EXAMPLE 2: NESTED TABLES

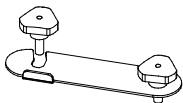
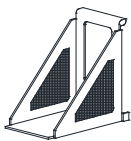

PLEASE REFER TO PAGE **FLX-8 - FLX-9**, 'FLEX SERIES LAMINATE TABLE TOP & BASE CHART' FOR RECOMMENDED TOP & BASE COMBINATIONS.

| MODEL | LIST | WEIGHT | CUBE            | W  | D  | H  |
|-------|------|--------|-----------------|----|----|----|
|       |      | LBS    | FT <sup>3</sup> | IN | IN | IN |

**TRAINING TABLE BASES**

30" TUCANA ELITE BASE

|                  |              |    |     |       |       |       |
|------------------|--------------|----|-----|-------|-------|-------|
| <b>TU-98B-30</b> | <b>\$661</b> | 28 | 3.1 | 27.25 | 21.75 | 28.75 |
|------------------|--------------|----|-----|-------|-------|-------|

48" TUCANA ELITE BASE

**NEW!**

|                  |              |      |     |       |       |       |
|------------------|--------------|------|-----|-------|-------|-------|
| <b>TU-98B-48</b> | <b>\$675</b> | 31.2 | 3.5 | 44.75 | 21.75 | 28.75 |
|------------------|--------------|------|-----|-------|-------|-------|

- SHIPS IN 2 CARTONS

60" TUCANA ELITE BASE

|                  |              |    |     |       |       |       |
|------------------|--------------|----|-----|-------|-------|-------|
| <b>TU-98B-60</b> | <b>\$720</b> | 39 | 4.4 | 56.75 | 21.75 | 28.75 |
|------------------|--------------|----|-----|-------|-------|-------|

- SHIPS IN 2 CARTONS

72" TUCANA ELITE BASE

|                  |              |      |     |       |       |       |
|------------------|--------------|------|-----|-------|-------|-------|
| <b>TU-98B-72</b> | <b>\$785</b> | 43.6 | 4.8 | 68.75 | 21.75 | 28.75 |
|------------------|--------------|------|-----|-------|-------|-------|

- SHIPS IN 2 CARTONS
- FLIP TOP MECHANISM WITH NEST DESIGN. EASY TO USE TWIST KNOB FOR FLIP TOP ENABLES ONE PERSON TO EASILY FLIP.
- SMOOTH GLIDE CASTERS FOR EASY MOVEMENT. INCLUDES MODESTY PANEL.

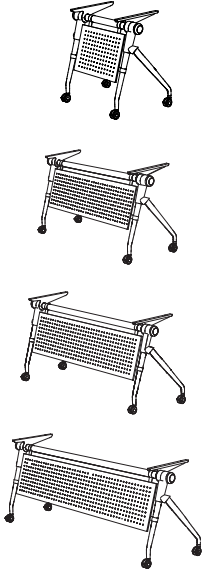

**EXAMPLES**

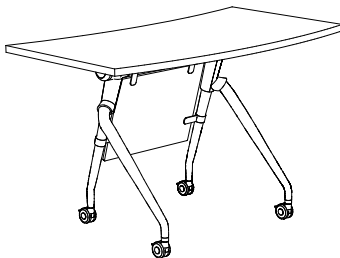

TU-98B-30 SHOWN WITH FLXS-WAV2442



TU-98B-60 SHOWN WITH FLX-REC3060

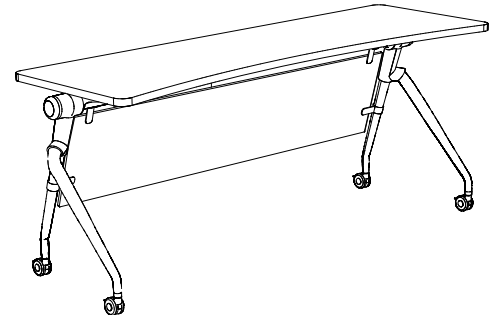

TU-98B-72 SHOWN WITH FLX-RECS2472

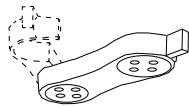

**OPTIONAL GANGING HARDWARE**

SET OF 2.







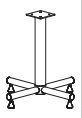
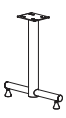
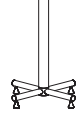
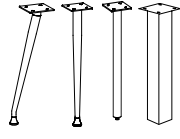
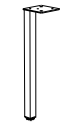
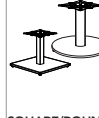
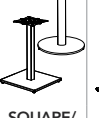
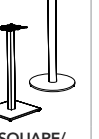

|                   |             |     |      |  |  |  |
|-------------------|-------------|-----|------|--|--|--|
| <b>TU-98B-TGH</b> | <b>\$29</b> | 1.0 | 0.04 |  |  |  |
|-------------------|-------------|-----|------|--|--|--|

# FLEX SERIES LAMINATE TABLE TOP & BASE CHART

USE THIS CHART AS A GUIDE TO DETERMINE LAMINATE TABLE TOP & BASE COMBINATIONS FOR STAND ALONE/SINGLE TABLES.

BASE REQUIREMENTS MAY ALTER DEPENDANT ON DESIRED LAYOUT CONFIGURATION.

CONTACT CUSTOMER SERVICE FOR ADDITIONAL DETAILS.













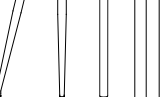





| FLEX SERIES TABLE TOPS<br>- REF FLX-10   |                      | 900 SERIES BASES - REF FLX-3  |   |   |   |   |  |   |   |   |   | TUCANA SERIES BASES-<br>REF FLX-6<br>TUCANA<br>TUCANA ELITE                         |             |
|--|----------------------|---|---|---|---|---|--|---|---|---|---|---|-------------|
|  |                      |  |  |  |  |  |  |  |  |  |  |  |             |
| TOP TYPE   | DIMENSIONS<br>L X W* | MODEL   | MODEL   | MODEL   | MODEL   | MODEL   | MODEL  | MODEL   | MODEL   | MODEL   | MODEL   | MODEL   |             |
| ↑  | 2430                 | 23.75 X 29.5  | 1-CROSS24   | 2-TEE24   | 1-BAR24   | 4-SPIDER/TAPER/RL2.5/SQ3  | 2-SQ2OFFSET  | 1-SQB20CFT/<br>1-ROU20CFT   | 1-SQB20/<br>1-ROU20   | 1-SQB20BAR/<br>1-ROU20BAR   | 2-LOOP24  | 1-TU-97L-2420   | 1-TU-98B-30 |
|  | 2436                 | 23.75 X 35.5  | 1-CROSS24   | 2-TEE24   | 1-BAR24   | 4-SPIDER/TAPER/RL2.5/SQ3  | 2-SQ2OFFSET  | 1-SQB20CFT/<br>1-ROU20CFT   | 1-SQB20/<br>1-ROU20   | 1-SQB20BAR/<br>1-ROU20BAR   | 2-LOOP24  | 1-TU-97L-2420   | 1-TU-98B-30 |
| ↓  | 2442                 | 23.75 X 41.5  | 1-CROSS24   | 2-TEE24   | 1-BAR24   | 4-SPIDER/TAPER/RL2.5/SQ3  | 2-SQ2OFFSET  | 1-SQB20CFT/<br>1-ROU20CFT   | 1-SQB20/<br>1-ROU20   | 1-SQB20BAR/<br>1-ROU20BAR   | 2-LOOP24  | 1-TU-97L-2420   | 1-TU-98B-30 |
|  | 2448                 | 23.75 X 47.25   | 2-CROSS24   | 2-TEE24   | 2-BAR24   | 4-SPIDER/TAPER/RL2.5/SQ3  | 2-SQ2OFFSET  | 2-SQB20CFT/<br>2-ROU20CFT   | 2-SQB20/<br>2-ROU20   | 2-SQB20BAR/<br>2-ROU20BAR   | 2-LOOP24  | 1-TU-97L-5420   | 1-TU-98B-48 |
| <br>RECTANGLE<br>OR            | 2454                 | 23.75 X 53.25   | 2-CROSS24   | 2-TEE24   | 2-BAR24   | 4-SPIDER/TAPER/RL2.5/SQ3  | 2-SQ2OFFSET  | 2-SQB20CFT/<br>2-ROU20CFT   | 2-SQB20/<br>2-ROU20   | 2-SQB20BAR/<br>2-ROU20BAR   | 2-LOOP24  | 1-TU-97L-5420   | 1-TU-98B-48 |
|  | 2460                 | 23.75 X 59  | 2-CROSS24   | 2-TEE24   | 2-BAR24   | 4-SPIDER/TAPER/RL2.5/SQ3  | 2-SQ2OFFSET  | 2-SQB20CFT/<br>2-ROU20CFT   | 2-SQB20/<br>2-ROU20   | 2-SQB20BAR/<br>2-ROU20BAR   | 2-LOOP24  | 1-TU-97L-5420<br>OR 7220  | 1-TU-98B-60 |
| <br>RECTANGLE<br>SCOOPED<br>OR | 2466                 | 23.75 X 65  | 2-CROSS24   | 2-TEE24   | 2-BAR24   | 4-SPIDER/TAPER/RL2.5/SQ3  | 2-SQ2OFFSET  | 2-SQB20CFT/<br>2-ROU20CFT   | 2-SQB20/<br>2-ROU20   | 2-SQB20BAR/<br>2-ROU20BAR   | 2-LOOP24  | 1-TU-97L-7220   | 1-TU-98B-60 |
|  | 2472                 | 23.75 X 71  | 2-CROSS24   | 2-TEE24   | 2-BAR24   | 4-SPIDER/TAPER/RL2.5/SQ3  | 2-SQ2OFFSET  | 2-SQB20CFT/<br>2-ROU20CFT   | 2-SQB20/<br>2-ROU20   | 2-SQB20BAR/<br>2-ROU20BAR   | 2-LOOP24  | 1-TU-97L-7220   | 1-TU-98B-72 |
| <br>RECTANGLE<br>BOWED<br>OR | 2484                 | 23.75 X 82.75   | 2-CROSS24   | 2-TEE24+1*  | 2-BAR24   | 4-SPIDER/TAPER/RL2.5/<br>SQ3+1*   | 2-SQ2OFFSET<br>+ 1*  | 2-SQB20CFT/<br>2-ROU20CFT   | 2-SQB20/<br>2-ROU20   | 2-SQB20BAR/<br>2-ROU20BAR   | 2-LOOP24 + 1*   | 1-TU-97L-7220   | 1-TU-98B-72 |
|  | 3036                 | 29.5 X 35.5   | 1-CROSS24   | 2-TEE30   | 1-BAR24   | 4-SPIDER/TAPER/RL2.5/SQ3  | 2-SQ2OFFSET  | 1-SQB20CFT/<br>1-ROU20CFT   | 1-SQB20/<br>1-ROU20   | 1-SQB20BAR/<br>1-ROU20BAR   | 2-LOOP30  | 1-TU-97L-2420   | 1-TU-98B-30 |
| <br>RECTANGLE<br>BOWED<br>OR | 3042                 | 29.5 X 41.5   | 1-CROSS24   | 2-TEE30   | 1-BAR24   | 4-SPIDER/TAPER/RL2.5/SQ3  | 2-SQ2OFFSET  | 1-SQB20CFT/<br>1-ROU20CFT   | 1-SQB20/<br>1-ROU20   | 1-SQB20BAR/<br>1-ROU20BAR   | 2-LOOP30  | 1-TU-97L-2420   | 1-TU-98B-30 |
|  | 3048                 | 29.5 X 47.25  | 2-CROSS24   | 2-TEE30   | 2-BAR24   | 4-SPIDER/TAPER/RL2.5/SQ3  | 2-SQ2OFFSET  | 2-SQB20CFT/<br>2-ROU20CFT   | 2-SQB20/<br>2-ROU20   | 2-SQB20BAR/<br>2-ROU20BAR   | 2-LOOP30  | 1-TU-97L-5420   | 1-TU-98B-48 |
| ↓  | 3054                 | 29.5 X 53.25  | 2-CROSS24   | 2-TEE30   | 2-BAR24   | 4-SPIDER/TAPER/RL2.5/SQ3  | 2-SQ2OFFSET  | 2-SQB20CFT/<br>2-ROU20CFT   | 2-SQB20/<br>2-ROU20   | 2-SQB20BAR/<br>2-ROU20BAR   | 2-LOOP30  | 1-TU-97L-5420   | 1-TU-98B-48 |
|  | 3060                 | 29.5 X 59   | 2-CROSS24   | 2-TEE30   | 2-BAR24   | 4-SPIDER/TAPER/RL2.5/SQ3  | 2-SQ2OFFSET  | 2-SQB20CFT/<br>2-ROU20CFT   | 2-SQB20/<br>2-ROU20   | 2-SQB20BAR/<br>2-ROU20BAR   | 2-LOOP30  | 1-TU-97L-5420<br>OR 7220  | 1-TU-98B-60 |
| ↓  | 3066                 | 29.5 X 65   | 2-CROSS24   | 2-TEE30   | 2-BAR24   | 4-SPIDER/TAPER/RL2.5/SQ3  | 2-SQ2OFFSET  | 2-SQB20CFT/<br>2-ROU20CFT   | 2-SQB20/<br>2-ROU20   | 2-SQB20BAR/<br>2-ROU20BAR   | 2-LOOP30  | 1-TU-97L-7220   | 1-TU-98B-60 |
|  | 3072                 | 29.5 X 71   | 2-CROSS24   | 2-TEE30   | 2-BAR24   | 4-SPIDER/TAPER/RL2.5/SQ3  | 2-SQ2OFFSET  | 2-SQB20CFT/<br>2-ROU20CFT   | 2-SQB20/<br>2-ROU20   | 2-SQB20BAR/<br>2-ROU20BAR   | 2-LOOP30  | 1-TU-97L-7220   | 1-TU-98B-72 |
| ↓  | 3084                 | 29.5 X 82.75  | 2-CROSS24   | 2-TEE30+1*  | 2-BAR24   | 4-SPIDER/TAPER/RL2.5/<br>SQ3+1*   | 2-SQ2OFFSET<br>+ 1*  | 2-SQB20CFT/<br>2-ROU20CFT   | 2-SQB20/<br>2-ROU20   | 2-SQB20BAR/<br>2-ROU20BAR   | 2-LOOP30 + 1*   | 1-TU-97L-7220   | 1-TU-98B-72 |
|  | 3642                 | 35.5 X 41.5   | 1-CROSS24   | 2-TEE36   | 1-BAR24   | 4-SPIDER/TAPER/RL2.5/SQ3  | 2-SQ2OFFSET  | 1-SQB20CFT/<br>1-ROU20CFT   | 1-SQB20/<br>1-ROU20   | 1-SQB20BAR/<br>1-ROU20BAR   | 2-LOOP30  | N/A   | N/A         |
| ↓  | 3648                 | 35.5 X 47.25  | 2-CROSS24   | 2-TEE36   | 2-BAR24   | 4-SPIDER/TAPER/RL2.5/SQ3  | 2-SQ2OFFSET  | 2-SQB20CFT/<br>2-ROU20CFT   | 2-SQB20/<br>2-ROU20   | 2-SQB20BAR/<br>2-ROU20BAR   | 2-LOOP30  | N/A   | N/A         |
|  | 3654                 | 35.5 X 53.25  | 2-CROSS24   | 2-TEE36   | 2-BAR24   | 4-SPIDER/TAPER/RL2.5/SQ3  | 2-SQ2OFFSET  | 2-SQB20CFT/<br>2-ROU20CFT   | 2-SQB20/<br>2-ROU20   | 2-SQB20BAR/<br>2-ROU20BAR   | 2-LOOP30  | N/A   | N/A         |
| ↓  | 3660                 | 35.5 X 59   | 2-CROSS24   | 2-TEE36   | 2-BAR24   | 4-SPIDER/TAPER/RL2.5/SQ3  | 2-SQ2OFFSET  | 2-SQB20CFT/<br>2-ROU20CFT   | 2-SQB20/<br>2-ROU20   | 2-SQB20BAR/<br>2-ROU20BAR   | 2-LOOP30  | N/A   | N/A         |
|  | 3666                 | 35.5 X 65   | 2-CROSS24   | 2-TEE36   | 2-BAR24   | 4-SPIDER/TAPER/RL2.5/SQ3  | 2-SQ2OFFSET  | 2-SQB20CFT/<br>2-ROU20CFT   | 2-SQB20/<br>2-ROU20   | 2-SQB20BAR/<br>2-ROU20BAR   | 2-LOOP30  | N/A   | N/A         |
| ↓  | 3672                 | 35.5 X 71   | 2-CROSS24   | 2-TEE36   | 2-BAR24   | 4-SPIDER/TAPER/RL2.5/SQ3  | 2-SQ2OFFSET  | 2-SQB20CFT/<br>2-ROU20CFT   | 2-SQB20/<br>2-ROU20   | 2-SQB20BAR/<br>2-ROU20BAR   | 2-LOOP30  | N/A   | N/A         |
|  | 3684                 | 35.5 X 82.75  | 2-CROSS24   | 2-TEE36+1*  | 2-BAR24   | 4-SPIDER/TAPER/RL2.5/<br>SQ3+1*   | 2-SQ2OFFSET<br>+ 1*  | 2-SQB20CFT/<br>2-ROU20CFT   | 2-SQB20/<br>2-ROU20   | 2-SQB20BAR/<br>2-ROU20BAR   | 2-LOOP30+1*   | N/A   | N/A         |



USE THIS CHART AS A GUIDE TO DETERMINE LAMINATE TABLE TOP & BASE COMBINATIONS FOR STAND ALONE/SINGLE TABLES.

BASE REQUIREMENTS MAY ALTER DEPENDANT ON DESIRED LAYOUT CONFIGURATION.

CONTACT CUSTOMER SERVICE FOR ADDITIONAL DETAILS.

| FLEX SERIES TABLE TOPS<br>- REF <i>FLX-10</i>                                       |                            |                      | 900 SERIES BASES - REF <i>FLX-3</i>   |   |   |   |   |   |   |   |   | TUCANA SERIES BASES<br>REF <i>FLX-6</i><br>TUCANA<br>TUCANA ELITE                   |   |
|---|----------------------------|----------------------|---|---|---|---|---|---|---|---|---|---|---|
| TOP TYPE  | TOP MODEL NUMBER<br>(FLX-) | DIMENSIONS<br>L X W" |  |  |  |  |  |  |  |  |  |  |  |
|   |                            |                      | MODEL   | MODEL   | MODEL   | MODEL   | MODEL   | MODEL   | MODEL   | MODEL   | MODEL   | MODEL   | MODEL   |
|    | <b>SQ2424</b>              | 23.75 X 23.75        | 1-CROSS24   | 2-TEE24   | 1-BAR24   | 4-SPIDER/TAPER/RL2.5/SQ3  | 2-SQ2OFFSET   | 1-SQB20CFT/<br>1-ROU20FT  | 1-SQB20/<br>1-ROU20   | 1-SQB20BAR/<br>1-ROU20BAR   | 2-LOOP24  | 1-TU-97L-1520   | N/A   |
|   | <b>SQ3030</b>              | 29.5 X 29.5          | 1-CROSS24   | 2-TEE30   | 1-BAR24   | 4-SPIDER/TAPER/RL2.5/SQ3  | 2-SQ2OFFSET   | 1-SQB20CFT/<br>1-ROU20FT  | 1-SQB20/<br>1-ROU20   | 1-SQB20BAR/<br>1-ROU20BAR   | 2-LOOP30  | 1-TU-97L-2420   | N/A   |
|   | <b>SQ3636</b>              | 35.5 X 35.5          | 1-CROSS30   | 2-TEE36   | 1-BAR30   | 4-SPIDER/TAPER/RL2.5/SQ3  | 2-SQ2OFFSET   | 1-SQB20CFT/<br>1-ROU20FT  | 1-SQB20/<br>1-ROU20   | 1-SQB20BAR/<br>1-ROU20BAR   | 2-LOOP30  | N/A   | N/A   |
|   | <b>SQ4242</b>              | 41.5 X 41.5          | 1-CROSS30   | 2-TEE36   | 1-BAR30   | 4-SPIDER/TAPER/RL2.5/SQ3  | 2-SQ2OFFSET   | 1-SQB20CFT/<br>1-ROU20FT  | 1-SQB20/<br>1-ROU20   | N/A   | N/A   | N/A   | N/A   |
|   | <b>SQ4848</b>              | 47.25 X 47.25        | 1-CROSS30   | 2-TEE36   | 1-BAR30   | 4-SPIDER/TAPER/RL2.5/SQ3  | 2-SQ2OFFSET   | N/A   | N/A   | N/A   | N/A   | N/A   | N/A   |
|    | <b>R30</b>                 | 29.5 $\phi$          | 1-CROSS24   | N/A   | 1-BAR24   | 4-SPIDER/TAPER/RL2.5/SQ3  | 2-SQ2OFFSET   | 1-SQB20CFT/<br>1-ROU20FT  | 1-SQB20/<br>1-ROU20   | 1-SQB20BAR/<br>1-ROU20BAR   | N/A   | N/A   | N/A   |
|   | <b>R36</b>                 | 35.5 $\phi$          | 1-CROSS30   | N/A   | 1-BAR30   | 4-SPIDER/TAPER/RL2.5/SQ3  | 2-SQ2OFFSET   | 1-SQB20CFT/<br>1-ROU20FT  | 1-SQB20/<br>1-ROU20   | 1-SQB20BAR/<br>1-ROU20BAR   | N/A   | N/A   | N/A   |
|   | <b>R42</b>                 | 41.5 $\phi$          | 1-CROSS30   | N/A   | 1-BAR30   | 4-SPIDER/TAPER/RL2.5/SQ3  | 2-SQ2OFFSET   | 1-SQB20CFT/<br>1-ROU20FT  | 1-SQB20/<br>1-ROU20   | N/A   | N/A   | N/A   | N/A   |
|   | <b>R48</b>                 | 47.25 $\phi$         | 1-CROSS30   | N/A   | 1-BAR30   | 4-SPIDER/TAPER/RL2.5/<br>SQ3 +1*  | 2-SQ2OFFSET   | 1-SQB20CFT/<br>1-ROU20FT  | 1-SQB20/<br>1-ROU20   | N/A   | N/A   | N/A   | N/A   |
|  | <b>TR2448</b>              | 23.75 X 47.25        | 1-CROSS24   | 2-TEE24   | 1-BAR24   | 4-SPIDER/TAPER/RL2.5/SQ3  | 2-SQ2OFFSET   | N/A   | N/A   | N/A   | N/A   | 1-TU-97L-2420   | 1-TU-98B-30   |
|   | <b>TR2460</b>              | 23.75 X 59           | 1-CROSS30   | 2-TEE24   | 1-BAR30   | 4-SPIDER/TAPER/RL2.5/SQ3  | 2-SQ2OFFSET   | N/A   | N/A   | N/A   | N/A   | 1-TU-97L-2420   | 1-TU-98B-30   |
|   | <b>TR3060</b>              | 29.5 X 59            | 2-CROSS24   | 2-TEE30   | 2-BAR24   | 4-SPIDER/TAPER/RL2.5/SQ3  | 2-SQ2OFFSET   | N/A   | N/A   | N/A   | N/A   | 1-TU-97L-2420   | 1-TU-98B-30   |
|   | <b>TR3072</b>              | 29.5 X 71            | 2-CROSS24   | 2-TEE30   | 2-BAR24   | 4-SPIDER/TAPER/RL2.5/SQ3  | 2-SQ2OFFSET   | N/A   | N/A   | N/A   | N/A   | 1-TU-97L-5420   | 1-TU-98B-48   |
|   | <b>TR3672</b>              | 35.5 X 71            | 2-CROSS24   | 2-TEE36   | 2-BAR24   | 4-SPIDER/TAPER/RL2.5/SQ3  | 2-SQ2OFFSET   | N/A   | N/A   | N/A   | N/A   | N/A   | N/A   |
|   | <b>TR3684</b>              | 35.5 X 82.75         | 2-CROSS30   | 2-TEE30 +1*   | 2-BAR30   | 4-SPIDER/TAPER/RL2.5/<br>SQ3 +1*  | 2-SQ2OFFSET<br>+1   | N/A   | N/A   | N/A   | N/A   | N/A   | N/A   |
|  | <b>HM2448</b>              | 23.75 X 47.25        | 2-CROSS24   | 2-TEE24   | 2-BAR24   | 3-SPIDER/TAPER/RL2.5/SQ3  | 2-SQ2OFFSET   | N/A   | N/A   | N/A   | N/A   | 1-TU-97L-2420   | N/A   |
|   | <b>HM3060</b>              | 29.5 X 59            | 2-CROSS24   | 2-TEE30   | 2-BAR24   | 3-SPIDER/TAPER/RL2.5/SQ3  | 2-SQ2OFFSET   | N/A   | N/A   | N/A   | N/A   | 1-TU-97L-2420   | N/A   |
|   | <b>HM3672</b>              | 35.5 X 71            | 2-CROSS30   | 2-TEE36   | 2-BAR30   | 3-SPIDER/TAPER/RL2.5/SQ3  | 2-SQ2OFFSET   | N/A   | N/A   | N/A   | N/A   | N/A   | N/A   |
|  | <b>HD2454</b>              | 23.75 X 53.25        | 1-CROSS24   | 2-TEE24   | 1-BAR24   | 3-SPIDER/TAPER/RL2.5/SQ3  | 2-SQ2OFFSET   | N/A   | N/A   | N/A   | N/A   | 1-TU-97L-2420   | N/A   |
|   | <b>HD3066</b>              | 29.5 X 65            | 2-CROSS24   | 2-TEE30   | 2-BAR24   | 3-SPIDER/TAPER/RL2.5/SQ3  | 2-SQ2OFFSET   | N/A   | N/A   | N/A   | N/A   | 1-TU-97L-2420   | N/A   |
|   | <b>HD3678</b>              | 35.5 X 76.75         | 2-CROSS30   | 2-TEE36   | 2-BAR30   | 3-SPIDER/TAPER/RL2.5/SQ3  | 2-SQ2OFFSET   | N/A   | N/A   | N/A   | N/A   | N/A   | N/A   |
|  | <b>TD36</b>                | 35.5 X 35.5          | 1-CROSS24   | 1-TEE24 **  | 1-BAR24   | 1-TAPER/RL2.5/SQ3***  | 2-SQ2OFFSET   | 1-SQB20CFT/<br>1-ROU20CFT   | 1-SQB20/<br>1-ROU20   | 1-SQB20BAR/<br>1-ROU20BAR   | N/A   | 1-TU-97L-2420   | N/A   |
|   | <b>TD48</b>                | 47.25 X 47.25        | 1-CROSS30   | 1-TEE30**   | 1-BAR30   | 1-TAPER/RL2.5/SQ3***  | 2-SQ2OFFSET   | 1-SQB20CFT**/<br>1-ROU20CFT**   | 1-SQB20**/<br>1-ROU20**   | 1-SQB20BAR**/<br>1-ROU20BAR**   | N/A   | 1-TU-97L-2420   | N/A   |
|   | <b>TD60</b>                | 59 X 59              | 1-CROSS36   | 1-TEE36**   | 1-BAR36   | 1-TAPER/RL2.5/SQ3***  | 2-SQ2OFFSET   | 1-SQB20CFT**/<br>1-ROU20CFT**   | 1-SQB20**/<br>1-ROU20**   | 1-SQB20BAR**/<br>1-ROU20BAR**   | N/A   | 1-TU-97L-5420   | N/A   |
|  | <b>QR24</b>                | 23.75 X 23.75        | N/A   | 2-TEE24   | N/A   | N/A   | N/A   | N/A   | N/A   | N/A   | N/A   | N/A   | N/A   |
|   | <b>QR30</b>                | 29.5 X 29.5          | 1-CROSS24   | 2-TEE30   | 1-BAR24   | N/A   | N/A   | N/A   | N/A   | N/A   | N/A   | 1-TU-97L-1520   | N/A   |
|   | <b>QR36</b>                | 35.5 X 35.5          | 1-CROSS24   | 2-TEE36   | 1-BAR24   | N/A   | N/A   | N/A   | N/A   | N/A   | N/A   | N/A   | N/A   |
|  | <b>QD24</b>                | 26.75 X 26.75        | N/A   | 2-TEE24   | N/A   | N/A   | N/A   | N/A   | N/A   | N/A   | N/A   | 1-TU-97L-1520   | N/A   |
|   | <b>QD30</b>                | 32.5 X 32.5          | 1-CROSS24   | 2-TEE30   | 1-BAR24   | N/A   | N/A   | N/A   | N/A   | N/A   | N/A   | 1-TU-97L-1520   | N/A   |
|   | <b>QD36</b>                | 38.5 X 38.5          | 1-CROSS24   | 2-TEE36   | 1-BAR24   | N/A   | N/A   | N/A   | N/A   | N/A   | N/A   | N/A   | N/A   |

**NOTES:** \*CENTER SUPPORT IS REQUIRED PLEASE CALL CUSTOMER SERVICE.

















\*\*REQUIRES CONNECTING SQUARE END OF TEAR DROP TOP TO BE BRACKETED TO ADJOINING UNIT OTHERWISE 2 LEGS ARE REQUIRED.

\*\*\*REQUIRES CONNECTING SQUARE END OF TEAR DROP TOP TO BE BRACKETED TO ADJOINING UNIT OTHERWISE 4 LEGS ARE REQUIRED.

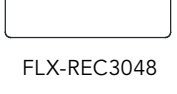
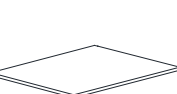
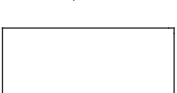
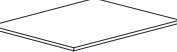
# FLEX TABLE TOPS

## RECTANGLE TOPS

- BY DEFAULT ALL TOPS ARE 1" LAMINATE WITH SQUARE CORNERS. USE **FLXS** PRICING AND SKU.
- FOR 2" RADIUS CORNERS USE THE SKU AND PRICING FOR **FLX**
- 1½" LAMINATE TOPS ARE AVAILABLE — USE "**FLXS2**" OR "**FLX2**" WHEN ORDERING
- HIGH PRESSURE LAMINATE AVAILABLE — CONTACT CUSTOMER SERVICE FOR DETAILS.
- AVAILABLE MODESTY PANELS ORDERED SEPARATELY.
- FACTORY INSTALLED 2" X 3" GROMMETS AVAILABLE - \$46 LIST PER GROMMET SEE PAGE 100-6. LOCATION MUST BE SPECIFIED WITH ORDER.
- TO GANG/CONNECT TOPS TOGETHER WITH HARDWARE, HML WILL DRILL FOR END TO END CONNECTION ONLY ON THE DEPTH END...SEE CONSTRUCTION DETAILS
- **FOR TABLE BASE COMPATIBILITY — REFER PAGE FLX-8 - FLX-9, 'FLEX SERIES LAMINATE TABLE TOP & BASE CHART'**

|   | MODEL        | LIST<br>FLXS | LIST<br>FLX | WEIGHT<br>LBS | CUBE<br>FT <sup>3</sup> | W<br>IN | D<br>IN | H<br>IN |
|---|--------------|--------------|-------------|---------------|-------------------------|---------|---------|---------|
| <b>24" RECTANGLE TOPS</b>   |              |              |             |               |                         |         |         |         |
|    | FLXS-REC2430 | \$189        | \$200       | 19            | 0.5                     | 29.5    | 23.75   | 1       |
|   | FLX-REC2448  |              |             |               |                         |         |         |         |
|    | FLXS-REC2436 | \$204        | \$216       | 25            | 0.5                     | 35.5    | 23.75   | 1       |
|    | FLXS-REC2442 | \$225        | \$240       | 28            | 0.6                     | 41.5    | 23.75   | 1       |
|   | FLX-REC2448  | \$246        | \$261       | 31            | 0.7                     | 47.25   | 23.75   | 1       |
|    | FLXS-REC2454 | \$265        | \$281       | 35            | 0.8                     | 53.25   | 23.75   | 1       |
|   | FLX-REC2448  |              |             |               |                         |         |         |         |
|    | FLXS-REC2460 | \$337        | \$358       | 38            | 0.9                     | 59.25   | 23.75   | 1       |
|   | FLX-REC2448  |              |             |               |                         |         |         |         |
|    | FLXS-REC2466 | \$367        | \$390       | 42            | 0.9                     | 65      | 23.75   | 1       |
|   | FLX-REC2448  |              |             |               |                         |         |         |         |
|   | FLXS-REC2472 | \$392        | \$416       | 46            | 1                       | 71      | 23.75   | 1       |
|   | FLX-REC2448  |              |             |               |                         |         |         |         |
| <p>FOR RADIUS CORNERS USE "FLX" WHEN ORDERING EXAMPLE: FLX-REC2472</p>              |              |              |             |               |                         |         |         |         |
| * CENTRE SUPPORT LEG REQUIRED, ADD LEG TO ORDER.                                    |              |              |             |               |                         |         |         |         |
| <b>FLXS-REC2484*</b> <b>\$526</b> <b>\$558</b> 53    1.2    82.75    23.75    1     |              |              |             |               |                         |         |         |         |
| <b>30" RECTANGLE TOPS</b>   |              |              |             |               |                         |         |         |         |
|   | FLXS-REC3036 | \$254        | \$270       | 29            | 0.6                     | 35.5    | 29.5    | 1       |
|   | FLX-REC3048  |              |             |               |                         |         |         |         |
|  | FLXS-REC3042 | \$263        | \$280       | 33            | 0.7                     | 41.5    | 29.5    | 1       |
|  | FLXS-REC3048 | \$285        | \$303       | 38            | 0.8                     | 47.25   | 29.5    | 1       |
|   | FLX-REC3048  |              |             |               |                         |         |         |         |
|  | FLXS-REC3054 | \$337        | \$358       | 43            | 1                       | 53.25   | 29.5    | 1       |
|   | FLX-REC3048  |              |             |               |                         |         |         |         |
|  | FLXS-REC3060 | \$384        | \$406       | 47            | 1.1                     | 59.25   | 29.5    | 1       |
|   | FLX-REC3048  |              |             |               |                         |         |         |         |
|  | FLXS-REC3066 | \$414        | \$439       | 52            | 1.2                     | 65      | 29.5    | 1       |
|   | FLX-REC3048  |              |             |               |                         |         |         |         |
|  | FLXS-REC3072 | \$437        | \$463       | 57            | 1.3                     | 71      | 29.5    | 1       |
|   | FLX-REC3048  |              |             |               |                         |         |         |         |
| * CENTRE SUPPORT LEG REQUIRED, ADD LEG TO ORDER.                                    |              |              |             |               |                         |         |         |         |
| <b>FLXS-REC3084*</b> <b>\$656</b> <b>\$694</b> 66    1.5    82.75    29.5    1      |              |              |             |               |                         |         |         |         |
| <b>36" RECTANGLE TOPS</b>   |              |              |             |               |                         |         |         |         |
|  | FLXS-REC3642 | \$393        | \$413       | 40            | 0.9                     | 41.5    | 35.5    | 1       |
|   | FLX-REC3648  |              |             |               |                         |         |         |         |
|  | FLXS-REC3648 | \$413        | \$435       | 46            | 1.1                     | 47.25   | 35.5    | 1       |
|  | FLXS-REC3654 | \$506        | \$532       | 51            | 1.1                     | 53.25   | 35.5    | 1       |
|   | FLX-REC3648  |              |             |               |                         |         |         |         |
|  | FLXS-REC3660 | \$525        | \$552       | 57            | 1.3                     | 59.25   | 35.5    | 1       |
|   | FLX-REC3648  |              |             |               |                         |         |         |         |
|  | FLXS-REC3666 | \$580        | \$610       | 62            | 1.4                     | 65      | 35.5    | 1       |
|   | FLX-REC3648  |              |             |               |                         |         |         |         |
|  | FLXS-REC3672 | \$615        | \$646       | 68            | 1.6                     | 71      | 35.5    | 1       |
|   | FLX-REC3648  |              |             |               |                         |         |         |         |
| * CENTRE SUPPORT LEG REQUIRED, ADD LEG TO ORDER.                                    |              |              |             |               |                         |         |         |         |
| <b>FLXS-REC3684*</b> <b>\$800</b> <b>\$840</b> 79    1.8    82.75    35.5    1      |              |              |             |               |                         |         |         |         |

- BY DEFAULT ALL TOPS ARE 1" LAMINATE WITH SQUARE CORNERS. USE **FLXS** PRICING AND SKU.
- FOR 1½" RADIUS CORNERS USE THE SKU AND PRICING FOR **FLX**
- 1½" LAMINATE TOPS ARE AVAILABLE — USE "**FLXS2**" OR "**FLX2**" WHEN ORDERING
- HIGH PRESSURE LAMINATE AVAILABLE — CONTACT CUSTOMER SERVICE FOR DETAILS.
- AVAILABLE MODESTY PANELS ORDERED SEPARATELY.
- FACTORY INSTALLED 2" X 3" GROMMETS AVAILABLE - **\$46** LIST PER GROMMET SEE PAGE **100-6**. LOCATION MUST BE SPECIFIED WITH ORDER
- **FOR TABLE BASE COMPATIBILITY — REFER PAGE [FLX-8](#) - [FLX-9](#), 'FLEX SERIES LAMINATE TABLE TOP & BASE CHART'**

| MODEL | LIST<br>FLXS | LIST<br>FLX | WEIGHT<br>LBS | CUBE<br>FT <sup>3</sup> | W<br>IN | D<br>IN | H<br>IN |
|-------|--------------|-------------|---------------|-------------------------|---------|---------|---------|
|-------|--------------|-------------|---------------|-------------------------|---------|---------|---------|

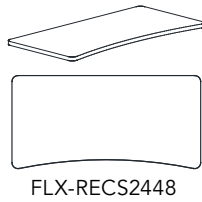
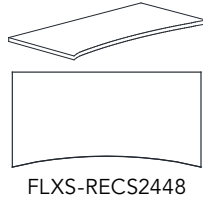

**24" RECTANGLE SCOOPED TOPS**

|   |              |              |    |     |       |       |   |
|---|--------------|--------------|----|-----|-------|-------|---|
| FLXS-RECS2436   | <b>\$233</b> | <b>\$247</b> | 25 | 0.5 | 35.5  | 23.75 | 1 |
| FLXS-RECS2442   | <b>\$248</b> | <b>\$263</b> | 28 | 0.6 | 41.5  | 23.75 | 1 |
| FLXS-RECS2448   | <b>\$263</b> | <b>\$280</b> | 31 | 0.7 | 47.25 | 23.75 | 1 |
| • TOPS > 48" INCLUDE ONE STIFFENER BAR IF ORDERED IN COMBINATION WITH APPLICABLE SUPPORTING BASE ON THE SAME PO |              |              |    |     |       |       |   |
| FLXS-RECS2454   | <b>\$279</b> | <b>\$296</b> | 35 | 0.8 | 53.25 | 23.75 | 1 |
| FLXS-RECS2460   | <b>\$307</b> | <b>\$326</b> | 38 | 0.9 | 59.25 | 23.75 | 1 |
| FLXS-RECS2466   | <b>\$384</b> | <b>\$406</b> | 42 | 0.9 | 65    | 23.75 | 1 |
| FLXS-RECS2472   | <b>\$414</b> | <b>\$439</b> | 46 | 1   | 71    | 23.75 | 1 |

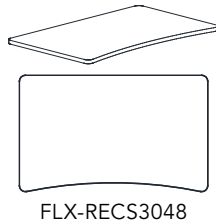
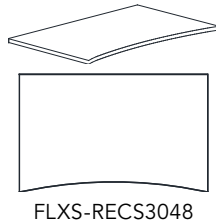

**30" RECTANGLE SCOOPED TOPS**

|   |              |              |    |     |       |      |   |
|---|--------------|--------------|----|-----|-------|------|---|
| FLXS-RECS3036   | <b>\$285</b> | <b>\$303</b> | 29 | 0.6 | 35.5  | 29.5 | 1 |
| FLXS-RECS3042   | <b>\$307</b> | <b>\$326</b> | 33 | 0.7 | 41.5  | 29.5 | 1 |
| FLXS-RECS3048   | <b>\$332</b> | <b>\$352</b> | 38 | 0.8 | 47.25 | 29.5 | 1 |
| • TOPS > 48" INCLUDE ONE STIFFENER BAR IF ORDERED IN COMBINATION WITH APPLICABLE SUPPORTING BASE ON THE SAME PO |              |              |    |     |       |      |   |
| FLXS-RECS3054   | <b>\$384</b> | <b>\$406</b> | 43 | 1   | 53.25 | 29.5 | 1 |
| FLXS-RECS3060   | <b>\$427</b> | <b>\$454</b> | 47 | 1.1 | 59.25 | 29.5 | 1 |
| FLXS-RECS3066   | <b>\$457</b> | <b>\$484</b> | 52 | 1.2 | 65    | 29.5 | 1 |
| FLXS-RECS3072   | <b>\$481</b> | <b>\$510</b> | 57 | 1.3 | 71    | 29.5 | 1 |

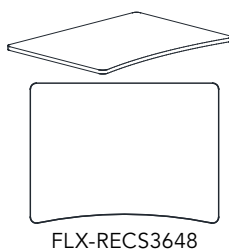
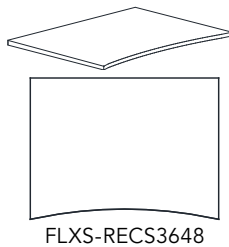

**36" RECTANGLE SCOOPED TOPS**

|   |              |              |    |     |       |      |   |
|---|--------------|--------------|----|-----|-------|------|---|
| FLXS-RECS3642   | <b>\$427</b> | <b>\$454</b> | 40 | 0.9 | 41.5  | 35.5 | 1 |
| FLXS-RECS3648   | <b>\$451</b> | <b>\$477</b> | 46 | 1.1 | 47.25 | 35.5 | 1 |
| • TOPS > 48" INCLUDE ONE STIFFENER BAR IF ORDERED IN COMBINATION WITH APPLICABLE SUPPORTING BASE ON THE SAME PO |              |              |    |     |       |      |   |
| FLXS-RECS3654   | <b>\$475</b> | <b>\$504</b> | 51 | 1.1 | 53.25 | 35.5 | 1 |
| FLXS-RECS3660   | <b>\$534</b> | <b>\$566</b> | 57 | 1.3 | 59.25 | 35.5 | 1 |
| FLXS-RECS3666   | <b>\$572</b> | <b>\$605</b> | 62 | 1.4 | 65    | 35.5 | 1 |
| • TOPS INCLUDE TWO STIFFENER BAR IF ORDERED IN COMBINATION WITH APPLICABLE SUPPORTING BASE ON THE SAME PO       |              |              |    |     |       |      |   |
| FLXS-RECS3672   | <b>\$647</b> | <b>\$687</b> | 68 | 1.6 | 71    | 35.5 | 1 |

# FLEX TABLE TOPS

## RECTANGLE BOWED TOPS

- BY DEFAULT ALL TOPS ARE 1" LAMINATE WITH SQUARE CORNERS. USE **FLXS** PRICING AND SKU.
- FOR 2" RADIUS CORNERS USE THE SKU AND PRICING FOR **FLX**
- 1½" LAMINATE TOPS ARE AVAILABLE — USE "**FLXS2**" OR "**FLX2**" WHEN ORDERING
- HIGH PRESSURE LAMINATE AVAILABLE — CONTACT CUSTOMER SERVICE FOR DETAILS.
- AVAILABLE MODESTY PANELS ORDERED SEPARATELY.
- FACTORY INSTALLED 2" X 3" GROMMETS AVAILABLE - **\$46** LIST PER GROMMET SEE PAGE **100-6**. LOCATION MUST BE SPECIFIED WITH ORDER.
- TO GANG/CONNECT TOPS TOGETHER WITH HARDWARE, HML WILL DRILL FOR END TO END CONNECTION ONLY ON THE DEPTH END...SEE CONSTRUCTION DETAILS
- **FOR TABLE BASE COMPATIBILITY — REFER PAGE [FLX-8](#) - [FLX-9](#), 'FLEX SERIES LAMINATE TABLE TOP & BASE CHART'**

| MODEL | LIST<br>FLXS | LIST<br>FLX | WEIGHT<br>LBS | CUBE<br>FT <sup>3</sup> | W<br>IN | D<br>IN | H<br>IN |
|-------|--------------|-------------|---------------|-------------------------|---------|---------|---------|
|-------|--------------|-------------|---------------|-------------------------|---------|---------|---------|

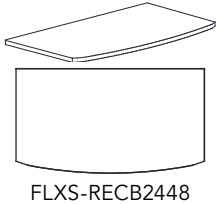

### 24" RECTANGLE BOWED TOPS

|  |       |       |    |     |       |       |   |
|--|-------|-------|----|-----|-------|-------|---|
| FLXS-RECB2436  | \$398 | \$421 | 27 | 0.6 | 35.5  | 23.75 | 1 |
| FLXS-RECB2442  | \$414 | \$439 | 30 | 0.7 | 41.5  | 23.75 | 1 |
| FLXS-RECB2448  | \$427 | \$454 | 32 | 0.8 | 47.25 | 23.75 | 1 |
| <ul style="list-style-type: none"> <li>• TOPS &gt; 48" INCLUDE ONE STIFFENER BAR IF ORDERED IN COMBINATION WITH APPLICABLE SUPPORTING BASE ON THE SAME PO</li> </ul> |       |       |    |     |       |       |   |
| FLXS-RECB2454  | \$452 | \$479 | 37 | 0.9 | 53.25 | 23.75 | 1 |
| FLXS-RECB2460  | \$534 | \$566 | 40 | 1   | 59.25 | 23.75 | 1 |
| FLXS-RECB2466  | \$548 | \$580 | 44 | 1   | 65    | 23.75 | 1 |
| FLXS-RECB2472  | \$567 | \$602 | 48 | 1.1 | 71    | 23.75 | 1 |

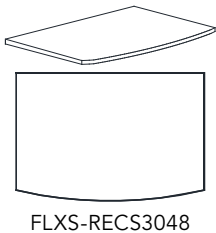
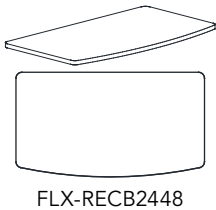

### 30" RECTANGLE BOWED TOPS

|  |       |       |    |     |       |      |   |
|--|-------|-------|----|-----|-------|------|---|
| FLXS-RECB3036  | \$466 | \$494 | 31 | 0.7 | 35.5  | 29.5 | 1 |
| FLXS-RECB3042  | \$490 | \$518 | 35 | 0.8 | 41.5  | 29.5 | 1 |
| FLXS-RECB3048  | \$511 | \$543 | 40 | 0.9 | 47.25 | 29.5 | 1 |
| <ul style="list-style-type: none"> <li>• TOPS &gt; 48" INCLUDE ONE STIFFENER BAR IF ORDERED IN COMBINATION WITH APPLICABLE SUPPORTING BASE ON THE SAME PO</li> </ul> |       |       |    |     |       |      |   |
| FLXS-RECB3054  | \$553 | \$586 | 45 | 1   | 53.25 | 29.5 | 1 |
| FLXS-RECB3060  | \$601 | \$637 | 49 | 1.1 | 59.25 | 29.5 | 1 |
| FLXS-RECB3066  | \$625 | \$663 | 54 | 1.3 | 65    | 29.5 | 1 |
| FLXS-RECB3072  | \$650 | \$690 | 58 | 1.4 | 71    | 29.5 | 1 |

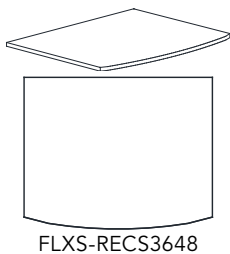
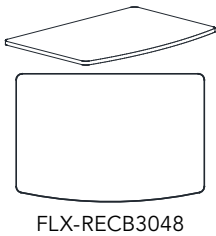

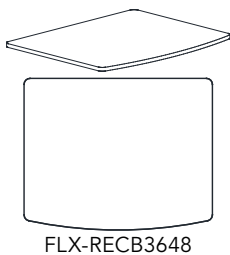

### 36" RECTANGLE BOWED TOPS

|  |       |       |    |     |       |      |   |
|--|-------|-------|----|-----|-------|------|---|
| FLXS-RECB3642  | \$579 | \$614 | 42 | 1   | 41.5  | 35.5 | 1 |
| FLXS-RECB3648  | \$600 | \$636 | 48 | 1.2 | 47.25 | 35.5 | 1 |
| <ul style="list-style-type: none"> <li>• TOPS &gt; 48" INCLUDE ONE STIFFENER BAR IF ORDERED IN COMBINATION WITH APPLICABLE SUPPORTING BASE ON THE SAME PO</li> </ul> |       |       |    |     |       |      |   |
| FLXS-RECB3654  | \$623 | \$661 | 53 | 1.3 | 53.25 | 35.5 | 1 |
| FLXS-RECB3660  | \$647 | \$687 | 59 | 1.4 | 59.25 | 35.5 | 1 |
| FLXS-RECB3666  | \$670 | \$710 | 64 | 1.5 | 65    | 35.5 | 1 |
| <ul style="list-style-type: none"> <li>• TOPS INCLUDE TWO STIFFENER BAR IF ORDERED IN COMBINATION WITH APPLICABLE SUPPORTING BASE ON THE SAME PO</li> </ul>          |       |       |    |     |       |      |   |
| FLXS-RECB3672  | \$707 | \$750 | 70 | 1.7 | 71    | 35.5 | 1 |

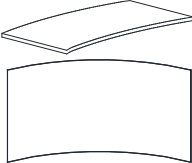
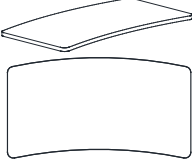
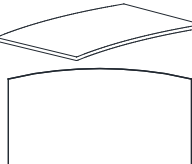
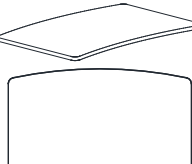
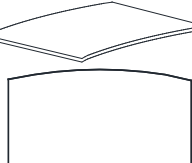
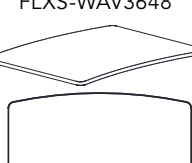

- BY DEFAULT ALL TOPS ARE 1" LAMINATE WITH SQUARE CORNERS. USE **FLXS** PRICING AND SKU.
- FOR 1½" RADIUS CORNERS USE THE SKU AND PRICING FOR **FLX**
- 1½" LAMINATE TOPS ARE AVAILABLE — USE "**FLXS2**" OR "**FLX2**" WHEN ORDERING
- HIGH PRESSURE LAMINATE AVAILABLE — CONTACT CUSTOMER SERVICE FOR DETAILS.
- AVAILABLE MODESTY PANELS ORDERED SEPARATELY.
- FACTORY INSTALLED 2" X 3" GROMMETS AVAILABLE - **\$46** LIST PER GROMMET SEE PAGE **100-6**. LOCATION MUST BE SPECIFIED WITH ORDER
- **FOR TABLE BASE COMPATIBILITY — REFER PAGE [FLX-8](#) - [FLX-9](#), 'FLEX SERIES LAMINATE TABLE TOP & BASE CHART'**

|   | MODEL        | LIST<br>FLXS | LIST<br>FLX | WEIGHT<br>LBS | CUBE<br>FT³ | W<br>IN | D<br>IN | H<br>IN |
|---|--------------|--------------|-------------|---------------|-------------|---------|---------|---------|
| <b>24" WAVE TOPS</b>  |              |              |             |               |             |         |         |         |
|                                | FLXS-WAV2436 | \$427        | \$454       | 27            | 0.6         | 35.5    | 23.75   | 1       |
|   | FLXS-WAV2442 | \$444        | \$471       | 30            | 0.7         | 41.5    | 23.75   | 1       |
| FLXS-WAV2448  | \$457        | \$484        | 32          | 0.8           | 47.25       | 23.75   | 1       |         |
| • TOPS > 48" INCLUDE ONE STIFFENER BAR IF ORDERED IN COMBINATION WITH APPLICABLE SUPPORTING BASE ON THE SAME PO |              |              |             |               |             |         |         |         |
|                                | FLXS-WAV2454 | \$481        | \$510       | 37            | 0.9         | 53.25   | 23.75   | 1       |
|   | FLXS-WAV2460 | \$563        | \$598       | 40            | 1           | 59.25   | 23.75   | 1       |
|   | FLXS-WAV2466 | \$578        | \$613       | 44            | 1           | 65      | 23.75   | 1       |
|   | FLXS-WAV2472 | \$598        | \$635       | 48            | 1.1         | 71      | 23.75   | 1       |
|   | FLX-WAV2448  |              |             |               |             |         |         |         |
| <b>30" WAVE TOPS</b>  |              |              |             |               |             |         |         |         |
|                               | FLXS-WAV3036 | \$497        | \$526       | 31            | 0.7         | 35.5    | 29.5    | 1       |
|   | FLXS-WAV3042 | \$519        | \$551       | 35            | 0.8         | 41.5    | 29.5    | 1       |
| FLXS-WAV3048  | \$541        | \$575        | 40          | 0.9           | 47.25       | 29.5    | 1       |         |
| • TOPS > 48" INCLUDE ONE STIFFENER BAR IF ORDERED IN COMBINATION WITH APPLICABLE SUPPORTING BASE ON THE SAME PO |              |              |             |               |             |         |         |         |
|                              | FLXS-WAV3054 | \$583        | \$618       | 45            | 1           | 53.25   | 29.5    | 1       |
|   | FLXS-WAV3060 | \$632        | \$670       | 49            | 1.1         | 59.25   | 29.5    | 1       |
|   | FLXS-WAV3066 | \$656        | \$694       | 54            | 1.3         | 65      | 29.5    | 1       |
|   | FLXS-WAV3072 | \$679        | \$722       | 58            | 1.4         | 71      | 29.5    | 1       |
|   | FLX-WAV3048  |              |             |               |             |         |         |         |
| <b>36" WAVE TOPS</b>  |              |              |             |               |             |         |         |         |
|                              | FLXS-WAV3642 | \$610        | \$644       | 42            | 1           | 41.5    | 35.5    | 1       |
|   | FLXS-WAV3648 | \$630        | \$666       | 48            | 1.2         | 47.25   | 35.5    | 1       |
| • TOPS > 48" INCLUDE ONE STIFFENER BAR IF ORDERED IN COMBINATION WITH APPLICABLE SUPPORTING BASE ON THE SAME PO |              |              |             |               |             |         |         |         |
|                              | FLXS-WAV3654 | \$655        | \$693       | 53            | 1.3         | 53.25   | 35.5    | 1       |
|   | FLXS-WAV3660 | \$677        | \$719       | 59            | 1.4         | 59.25   | 35.5    | 1       |
|   | FLXS-WAV3666 | \$697        | \$740       | 64            | 1.5         | 65      | 35.5    | 1       |
| • TOPS INCLUDE TWO STIFFENER BAR IF ORDERED IN COMBINATION WITH APPLICABLE SUPPORTING BASE ON THE SAME PO       |              |              |             |               |             |         |         |         |
|                              | FLXS-WAV3672 | \$739        | \$781       | 70            | 1.7         | 71      | 35.5    | 1       |
| FLX-WAV3648   |              |              |             |               |             |         |         |         |

# FLEX TABLE TOPS

## SHAPED TOPS

- BY DEFAULT ALL TOPS ARE 1" LAMINATE WITH SQUARE CORNERS. USE **FLXS** PRICING AND SKU.
- FOR 2" RADIUS CORNERS USE THE SKU AND PRICING FOR **FLX**
- 1½" LAMINATE TOPS ARE AVAILABLE — USE "**FLXS2**" OR "**FLX2**" WHEN ORDERING
- HIGH PRESSURE LAMINATE AVAILABLE — CONTACT CUSTOMER SERVICE FOR DETAILS.
- AVAILABLE MODESTY PANELS ORDERED SEPARATELY.
- FACTORY INSTALLED 2" X 3" GROMMETS AVAILABLE - **\$46** LIST PER GROMMET SEE PAGE **100-6**. LOCATION MUST BE SPECIFIED WITH ORDER.
- TO GANG/CONNECT TOPS TOGETHER WITH HARDWARE, HML WILL DRILL FOR END TO END CONNECTION ONLY ON THE DEPTH END...SEE CONSTRUCTION DETAILS
- **FOR TABLE BASE COMPATIBILITY — REFER PAGE [FLX-8](#) - [FLX-9](#), 'FLEX SERIES LAMINATE TABLE TOP & BASE CHART'**

| MODEL | LIST<br>FLXS | LIST<br>FLX | WEIGHT<br>LBS | CUBE<br>FT <sup>3</sup> | W<br>IN | D<br>IN | H<br>IN |
|-------|--------------|-------------|---------------|-------------------------|---------|---------|---------|
|-------|--------------|-------------|---------------|-------------------------|---------|---------|---------|

### SQUARE TOPS

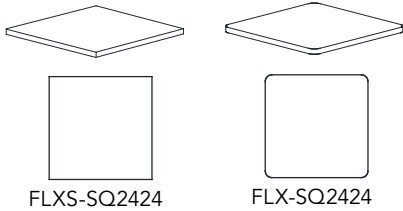

|             |       |       |    |    |       |       |   |
|-------------|-------|-------|----|----|-------|-------|---|
| FLXS-SQ2424 | \$201 | \$219 | 15 | .3 | 23.75 | 23.75 | 1 |
| FLXS-SQ3030 | \$247 | \$262 | 24 | .5 | 29.5  | 29.5  | 1 |
| FLXS-SQ3636 | \$311 | \$328 | 39 | .6 | 35.5  | 35.5  | 1 |
| FLXS-SQ4242 | \$385 | \$414 | 51 | .8 | 41.5  | 41.5  | 1 |
| FLXS-SQ4848 | \$477 | \$499 | 60 | 1  | 47.25 | 47.25 | 1 |

### ROUND TOPS



|          |       |     |    |     |       |       |   |
|----------|-------|-----|----|-----|-------|-------|---|
| FLXS-R30 | \$261 | N/A | 35 | 1.5 | 29.5  | 29.5  | 1 |
| FLXS-R36 | \$328 | N/A | 40 | 2   | 35.5  | 35.5  | 1 |
| FLXS-R42 | \$414 | N/A | 50 | 2.5 | 41.5  | 41.5  | 1 |
| FLXS-R48 | \$499 | N/A | 60 | 3   | 47.25 | 47.25 | 1 |

### TRAPEZOID TOPS

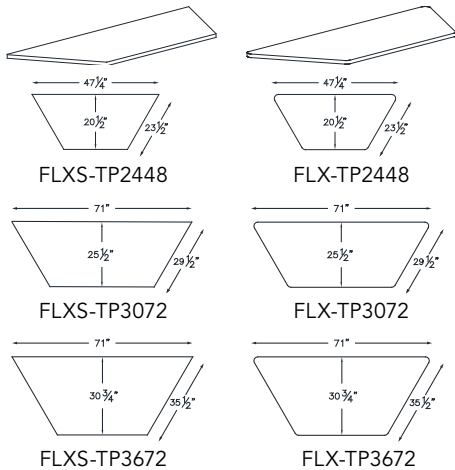

|             |       |       |    |     |       |       |   |
|-------------|-------|-------|----|-----|-------|-------|---|
| FLXS-TP2448 | \$191 | \$201 | 20 | 0.4 | 47.25 | 23.75 | 1 |
| FLXS-TP2460 | \$295 | \$312 | 27 | 0.6 | 59.25 | 23.75 | 1 |
| FLXS-TP3060 | \$377 | \$395 | 31 | 0.7 | 59.25 | 29.5  | 1 |
| FLXS-TP3072 | \$442 | \$465 | 40 | 0.9 | 71    | 29.5  | 1 |
| FLXS-TP3672 | \$522 | \$553 | 45 | 1   | 71    | 35.5  | 1 |

\* CENTRE SUPPORT LEG REQUIRED. ADD LEG TO ORDER.

|              |       |       |    |     |       |      |   |
|--------------|-------|-------|----|-----|-------|------|---|
| FLXS-TP3684* | \$722 | \$765 | 54 | 1.2 | 82.75 | 35.5 | 1 |
|--------------|-------|-------|----|-----|-------|------|---|

### HALF MOON TOPS

USE W/ 24" TOPS

|             |       |       |    |     |       |       |   |
|-------------|-------|-------|----|-----|-------|-------|---|
| FLXS-HM2448 | \$300 | \$323 | 24 | 0.5 | 47.25 | 23.75 | 1 |
|-------------|-------|-------|----|-----|-------|-------|---|

USE W/ 30" TOPS

|             |       |       |    |     |       |      |   |
|-------------|-------|-------|----|-----|-------|------|---|
| FLXS-HM3060 | \$387 | \$414 | 37 | 0.8 | 59.25 | 29.5 | 1 |
|-------------|-------|-------|----|-----|-------|------|---|

USE W/ 36" TOPS

|             |       |       |    |     |    |      |   |
|-------------|-------|-------|----|-----|----|------|---|
| FLXS-HM3672 | \$657 | \$696 | 54 | 1.2 | 71 | 35.5 | 1 |
|-------------|-------|-------|----|-----|----|------|---|

- BY DEFAULT ALL TOPS ARE 1" LAMINATE WITH SQUARE CORNERS. USE **FLXS** PRICING AND SKU.
- FOR 1½" RADIUS CORNERS USE THE SKU AND PRICING FOR **FLX**
- 1½" LAMINATE TOPS ARE AVAILABLE — USE "**FLXS2**" OR "**FLX2**" WHEN ORDERING
- HIGH PRESSURE LAMINATE AVAILABLE — CONTACT CUSTOMER SERVICE FOR DETAILS.
- AVAILABLE MODESTY PANELS ORDERED SEPARATELY.
- FACTORY INSTALLED 2" X 3" GROMMETS AVAILABLE - **\$46** LIST PER GROMMET SEE PAGE **100-6**. LOCATION MUST BE SPECIFIED WITH ORDER
- **FOR TABLE BASE COMPATIBILITY — REFER PAGE [FLX-8](#) - [FLX-9](#), 'FLEX SERIES LAMINATE TABLE TOP & BASE CHART'**

| MODEL | LIST<br>FLXS | LIST<br>FLX | WEIGHT<br>LBS | CUBE<br>FT³ | W<br>IN | D<br>IN | H<br>IN |
|-------|--------------|-------------|---------------|-------------|---------|---------|---------|
|-------|--------------|-------------|---------------|-------------|---------|---------|---------|

**HALF DONUT TOPS**

USE W/ 24" TOPS

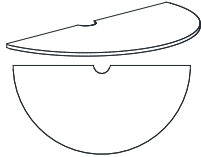

FLXS-HD3066

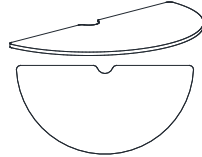

FLX-HD3066

|                    |              |              |           |            |              |              |          |
|--------------------|--------------|--------------|-----------|------------|--------------|--------------|----------|
| <b>FLXS-HD2454</b> | <b>\$363</b> | <b>\$381</b> | <b>26</b> | <b>0.5</b> | <b>53.25</b> | <b>23.75</b> | <b>1</b> |
|--------------------|--------------|--------------|-----------|------------|--------------|--------------|----------|

USE W/ 30" TOPS

|                    |              |              |           |            |           |             |          |
|--------------------|--------------|--------------|-----------|------------|-----------|-------------|----------|
| <b>FLXS-HD3066</b> | <b>\$414</b> | <b>\$442</b> | <b>39</b> | <b>0.8</b> | <b>65</b> | <b>29.5</b> | <b>1</b> |
|--------------------|--------------|--------------|-----------|------------|-----------|-------------|----------|

USE W/ 36" TOPS

|                    |              |              |           |            |           |             |          |
|--------------------|--------------|--------------|-----------|------------|-----------|-------------|----------|
| <b>FLXS-HD3678</b> | <b>\$714</b> | <b>\$757</b> | <b>56</b> | <b>1.2</b> | <b>77</b> | <b>35.5</b> | <b>1</b> |
|--------------------|--------------|--------------|-----------|------------|-----------|-------------|----------|

**TEARDROP TOP**



47.25"  
23.75"

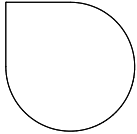

FLXS-TD48



47.25"  
23.75"

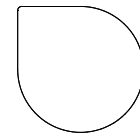

FLX-TD48

CONNECTS TO 18" WORKSURFACE.

|                  |              |              |           |            |             |             |          |
|------------------|--------------|--------------|-----------|------------|-------------|-------------|----------|
| <b>FLXS-TD36</b> | <b>\$463</b> | <b>\$491</b> | <b>42</b> | <b>1.2</b> | <b>35.5</b> | <b>35.5</b> | <b>1</b> |
|------------------|--------------|--------------|-----------|------------|-------------|-------------|----------|

CONNECTS TO 24" WORKSURFACE.

|                  |              |              |           |          |              |              |          |
|------------------|--------------|--------------|-----------|----------|--------------|--------------|----------|
| <b>FLXS-TD48</b> | <b>\$675</b> | <b>\$716</b> | <b>62</b> | <b>2</b> | <b>47.25</b> | <b>47.25</b> | <b>1</b> |
|------------------|--------------|--------------|-----------|----------|--------------|--------------|----------|

CONNECTS TO 30" WORKSURFACE.

|                  |              |              |           |            |           |           |          |
|------------------|--------------|--------------|-----------|------------|-----------|-----------|----------|
| <b>FLXS-TD60</b> | <b>\$869</b> | <b>\$921</b> | <b>92</b> | <b>3.2</b> | <b>59</b> | <b>59</b> | <b>1</b> |
|------------------|--------------|--------------|-----------|------------|-----------|-----------|----------|

**CONNECTING TOPS**

**QUARTER ROUND TOPS**

USE W/ 24" TOPS



FLXS-QR30



FLX-QR30

|                  |              |              |           |            |              |              |          |
|------------------|--------------|--------------|-----------|------------|--------------|--------------|----------|
| <b>FLXS-QR24</b> | <b>\$181</b> | <b>\$193</b> | <b>12</b> | <b>0.3</b> | <b>23.75</b> | <b>23.75</b> | <b>1</b> |
|------------------|--------------|--------------|-----------|------------|--------------|--------------|----------|

USE W/ 30" TOPS

|                  |              |              |           |            |             |             |          |
|------------------|--------------|--------------|-----------|------------|-------------|-------------|----------|
| <b>FLXS-QR30</b> | <b>\$211</b> | <b>\$223</b> | <b>19</b> | <b>0.4</b> | <b>29.5</b> | <b>29.5</b> | <b>1</b> |
|------------------|--------------|--------------|-----------|------------|-------------|-------------|----------|

USE W/ 36" TOPS

|                  |              |              |           |            |             |             |          |
|------------------|--------------|--------------|-----------|------------|-------------|-------------|----------|
| <b>FLXS-QR36</b> | <b>\$348</b> | <b>\$368</b> | <b>26</b> | <b>0.6</b> | <b>35.5</b> | <b>35.5</b> | <b>1</b> |
|------------------|--------------|--------------|-----------|------------|-------------|-------------|----------|

**QUARTER DONUT TOPS**

USE W/ 24" TOPS



FLXS-QD30



FLX-QD30

|                  |              |              |           |            |             |             |          |
|------------------|--------------|--------------|-----------|------------|-------------|-------------|----------|
| <b>FLXS-QD24</b> | <b>\$271</b> | <b>\$285</b> | <b>13</b> | <b>0.3</b> | <b>26.5</b> | <b>26.5</b> | <b>1</b> |
|------------------|--------------|--------------|-----------|------------|-------------|-------------|----------|

USE W/ 30" TOPS

|                  |              |              |           |            |             |             |          |
|------------------|--------------|--------------|-----------|------------|-------------|-------------|----------|
| <b>FLXS-QD30</b> | <b>\$392</b> | <b>\$416</b> | <b>19</b> | <b>0.4</b> | <b>32.5</b> | <b>32.5</b> | <b>1</b> |
|------------------|--------------|--------------|-----------|------------|-------------|-------------|----------|

USE W/ 36" TOPS

|                  |              |              |           |            |             |             |          |
|------------------|--------------|--------------|-----------|------------|-------------|-------------|----------|
| <b>FLXS-QD36</b> | <b>\$541</b> | <b>\$575</b> | <b>28</b> | <b>0.6</b> | <b>38.5</b> | <b>38.5</b> | <b>1</b> |
|------------------|--------------|--------------|-----------|------------|-------------|-------------|----------|

# FLEX TABLE TOPS

## SHAPED TOPS

- BY DEFAULT ALL TOPS ARE 1" LAMINATE WITH SQUARE CORNERS. USE **FLXS** PRICING AND SKU.
- FOR 2" RADIUS CORNERS USE THE SKU AND PRICING FOR **FLX**
- 1½" LAMINATE TOPS ARE AVAILABLE — USE "**FLXS2**" OR "**FLX2**" WHEN ORDERING
- HIGH PRESSURE LAMINATE AVAILABLE — CONTACT CUSTOMER SERVICE FOR DETAILS.
- AVAILABLE MODESTY PANELS ORDERED SEPARATELY.
- FACTORY INSTALLED 2" X 3" GROMMETS AVAILABLE - **\$46** LIST PER GROMMET SEE PAGE **100-6**. LOCATION MUST BE SPECIFIED WITH ORDER.
- TO GANG/CONNECT TOPS TOGETHER WITH HARDWARE, HML WILL DRILL FOR END TO END CONNECTION ONLY ON THE DEPTH END...SEE CONSTRUCTION DETAILS
- **FOR TABLE BASE COMPATIBILITY — REFER PAGE [FLX-8](#) - [FLX-9](#), 'FLEX SERIES LAMINATE TABLE TOP & BASE CHART'**

| MODEL | LIST<br>FLXS | LIST<br>FLX | WEIGHT<br>LBS | CUBE<br>FT <sup>3</sup> | W<br>IN | D<br>IN | H<br>IN |
|-------|--------------|-------------|---------------|-------------------------|---------|---------|---------|
|-------|--------------|-------------|---------------|-------------------------|---------|---------|---------|

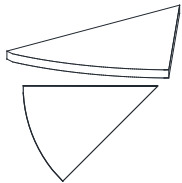

FLXS-WDG30

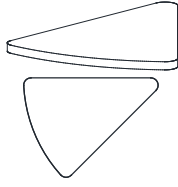

FLX-WD30

### WEDGE TOPS- 30° ANGLE

USE W/ 24" TOPS

|                   |              |              |          |            |              |              |          |
|-------------------|--------------|--------------|----------|------------|--------------|--------------|----------|
| <b>FLXS-WDG24</b> | <b>\$200</b> | <b>\$213</b> | <b>6</b> | <b>0.1</b> | <b>23.75</b> | <b>23.75</b> | <b>1</b> |
|-------------------|--------------|--------------|----------|------------|--------------|--------------|----------|

USE W/ 30" TOPS

|                   |              |              |          |            |             |             |          |
|-------------------|--------------|--------------|----------|------------|-------------|-------------|----------|
| <b>FLXS-WDG30</b> | <b>\$215</b> | <b>\$227</b> | <b>9</b> | <b>0.2</b> | <b>29.5</b> | <b>29.5</b> | <b>1</b> |
|-------------------|--------------|--------------|----------|------------|-------------|-------------|----------|

USE W/ 36" TOPS

|                   |              |              |           |            |             |             |          |
|-------------------|--------------|--------------|-----------|------------|-------------|-------------|----------|
| <b>FLXS-WDG36</b> | <b>\$243</b> | <b>\$258</b> | <b>13</b> | <b>0.3</b> | <b>35.5</b> | <b>35.5</b> | <b>1</b> |
|-------------------|--------------|--------------|-----------|------------|-------------|-------------|----------|

### TRIANGLE TOPS- 45° ANGLE

USE W/ 24" TOPS. 23¾" ON ALL SIDES.

|                  |              |              |          |            |              |              |          |
|------------------|--------------|--------------|----------|------------|--------------|--------------|----------|
| <b>FLXS-TR24</b> | <b>\$226</b> | <b>\$241</b> | <b>6</b> | <b>0.1</b> | <b>23.75</b> | <b>23.75</b> | <b>1</b> |
|------------------|--------------|--------------|----------|------------|--------------|--------------|----------|

USE W/ 30" TOPS. 29½" ON ALL SIDES.

|                  |              |              |           |            |             |             |          |
|------------------|--------------|--------------|-----------|------------|-------------|-------------|----------|
| <b>FLXS-TR30</b> | <b>\$257</b> | <b>\$272</b> | <b>11</b> | <b>0.2</b> | <b>29.5</b> | <b>29.5</b> | <b>1</b> |
|------------------|--------------|--------------|-----------|------------|-------------|-------------|----------|

USE W/ 36" TOPS. 35½" ON ALL SIDES.

|                  |              |              |           |            |             |             |          |
|------------------|--------------|--------------|-----------|------------|-------------|-------------|----------|
| <b>FLXS-TR36</b> | <b>\$279</b> | <b>\$296</b> | <b>15</b> | <b>0.3</b> | <b>35.5</b> | <b>35.5</b> | <b>1</b> |
|------------------|--------------|--------------|-----------|------------|-------------|-------------|----------|

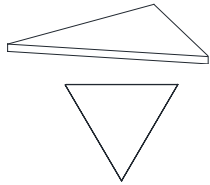

FLXS-TR30

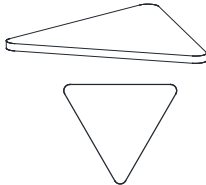

FLX-TR30

## MODESTY PANELS

### MODESTY PANELS

12" HIGH MODESTY. SQUARE CORNERS. INCLUDES ANGLE BRACKETS.

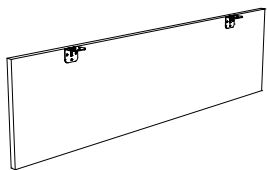

FLXS-MP48

|                  |              |     |          |            |              |            |           |
|------------------|--------------|-----|----------|------------|--------------|------------|-----------|
| <b>FLXS-MP30</b> | <b>\$172</b> | N/A | <b>8</b> | <b>0.2</b> | <b>25.75</b> | <b>.75</b> | <b>12</b> |
|------------------|--------------|-----|----------|------------|--------------|------------|-----------|

|                  |              |     |          |            |             |            |           |
|------------------|--------------|-----|----------|------------|-------------|------------|-----------|
| <b>FLXS-MP36</b> | <b>\$187</b> | N/A | <b>9</b> | <b>0.2</b> | <b>31.5</b> | <b>.75</b> | <b>12</b> |
|------------------|--------------|-----|----------|------------|-------------|------------|-----------|

|                  |              |     |           |            |             |            |           |
|------------------|--------------|-----|-----------|------------|-------------|------------|-----------|
| <b>FLXS-MP42</b> | <b>\$215</b> | N/A | <b>10</b> | <b>0.2</b> | <b>37.5</b> | <b>.75</b> | <b>12</b> |
|------------------|--------------|-----|-----------|------------|-------------|------------|-----------|

|                  |              |     |           |            |             |            |           |
|------------------|--------------|-----|-----------|------------|-------------|------------|-----------|
| <b>FLXS-MP48</b> | <b>\$222</b> | N/A | <b>12</b> | <b>0.3</b> | <b>43.5</b> | <b>.75</b> | <b>12</b> |
|------------------|--------------|-----|-----------|------------|-------------|------------|-----------|

|                  |              |     |           |            |              |            |           |
|------------------|--------------|-----|-----------|------------|--------------|------------|-----------|
| <b>FLXS-MP54</b> | <b>\$228</b> | N/A | <b>13</b> | <b>0.3</b> | <b>49.25</b> | <b>.75</b> | <b>12</b> |
|------------------|--------------|-----|-----------|------------|--------------|------------|-----------|

|                  |              |     |           |            |              |            |           |
|------------------|--------------|-----|-----------|------------|--------------|------------|-----------|
| <b>FLXS-MP60</b> | <b>\$243</b> | N/A | <b>15</b> | <b>0.3</b> | <b>55.25</b> | <b>.75</b> | <b>12</b> |
|------------------|--------------|-----|-----------|------------|--------------|------------|-----------|

|                  |              |     |           |            |           |            |           |
|------------------|--------------|-----|-----------|------------|-----------|------------|-----------|
| <b>FLXS-MP66</b> | <b>\$258</b> | N/A | <b>16</b> | <b>0.4</b> | <b>61</b> | <b>.75</b> | <b>12</b> |
|------------------|--------------|-----|-----------|------------|-----------|------------|-----------|

|                  |              |     |           |            |           |            |           |
|------------------|--------------|-----|-----------|------------|-----------|------------|-----------|
| <b>FLXS-MP72</b> | <b>\$272</b> | N/A | <b>17</b> | <b>0.4</b> | <b>67</b> | <b>.75</b> | <b>12</b> |
|------------------|--------------|-----|-----------|------------|-----------|------------|-----------|

|                  |              |     |           |            |              |            |           |
|------------------|--------------|-----|-----------|------------|--------------|------------|-----------|
| <b>FLXS-MP84</b> | <b>\$279</b> | N/A | <b>20</b> | <b>0.4</b> | <b>78.75</b> | <b>.75</b> | <b>12</b> |
|------------------|--------------|-----|-----------|------------|--------------|------------|-----------|



TOPS CAN BE COMBINED WITH ANY OF THE TABLE BASES AVAILABLE FOR THE FLEX SERIES.  
 COMBINATIONS ARE NOT LIMITED TO THE OPTIONS SHOWN. CONTACT CUSTOMER SERVICE FOR MORE OPTIONS.  
**FOR TABLE BASE COMPATIBILITY- REFER PAGE FLX-8 - FLX-9, 'FLEX SERIES LAMINATE TABLE TOP & BASE CHART'.**

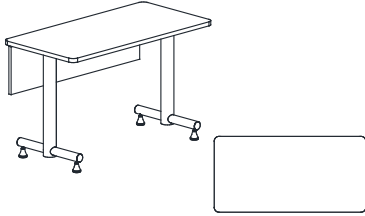

1. RECTANGLE TOP W/ MODESTY PANEL

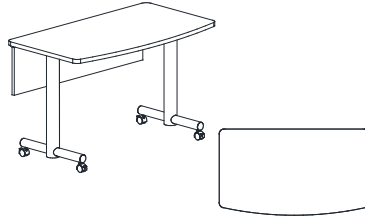

2. RECTANGLE BOWED TOP W/ MODESTY PANEL

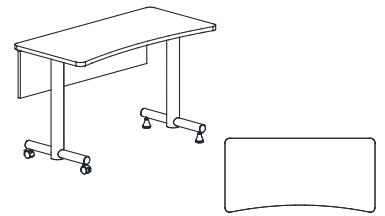

3. RECTANGLE SCOOPED TOP W/ MODESTY PANEL

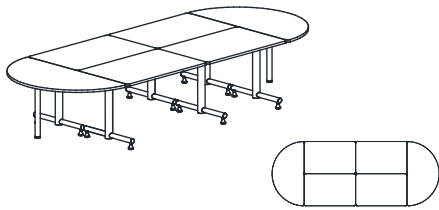

4. RECTANGLE TOPS W/ HALF MOON TOPS

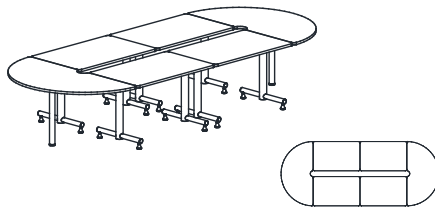

5. RECTANGLE TOPS W/ HALF DONUT TOPS

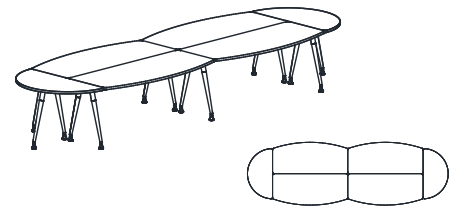

6. RECTANGLE BOWED TOPS W/ HALF MOON TOPS

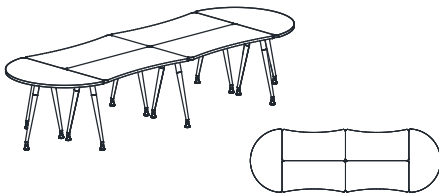

7. RECTANGLE SCOOPED TOPS W/ HALF MOON TOPS

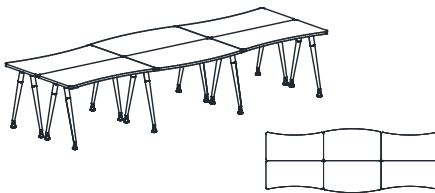

8. RECTANGLE SCOOPED TOPS W/ RECTANGLE BOWED TOPS

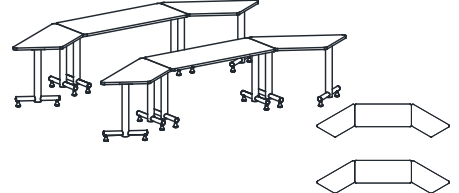

9. RECTANGLE TOPS W/ TRAPEZOID TOPS

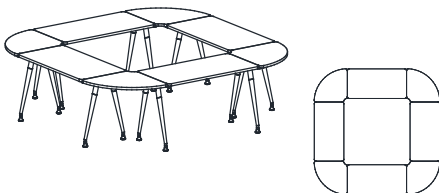

10. RECTANGLE TOPS W/ QUARTER DONUT TOPS

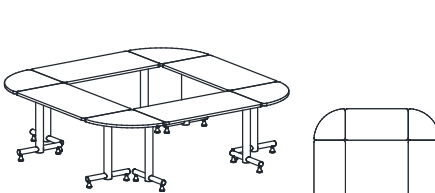

11. RECTANGLE TOPS W/ QUARTER ROUND TOPS

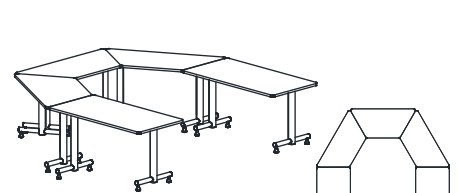

12. RECTANGLE TOPS W/ TRAPEZOID TOPS



13. TRAPEZOID TOPS

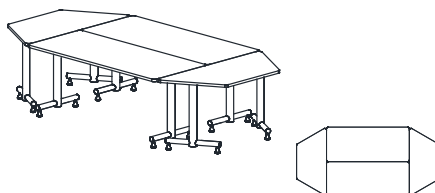

14. RECTANGLE TOPS W/ TRAPEZOID TOPS

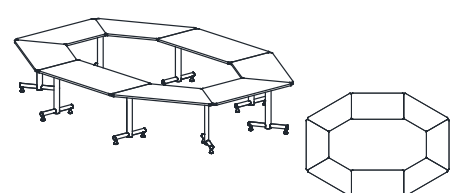

15. RECTANGLE TOPS W/ TRAPEZOID TOPS

TOPS CAN BE COMBINED WITH ANY OF THE TABLE BASES AVAILABLE FOR THE FLEX SERIES.  
 COMBINATIONS ARE NOT LIMITED TO THE OPTIONS SHOWN. CONTACT CUSTOMER SERVICE FOR MORE OPTIONS.  
**FOR TABLE BASE COMPATIBILITY- REFER PAGE FLX-8 - FLX-9, 'FLEX SERIES LAMINATE TABLE TOP & BASE CHART'.**

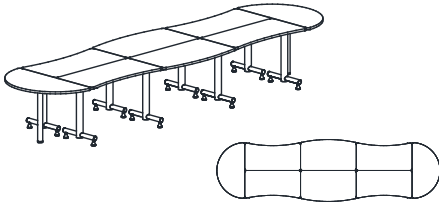

16. RECTANGLE BOWED TOPS + RECTANGLE SCOOPED TOPS W/ HALF MOON TOPS

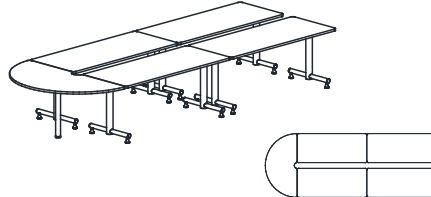

17. RECTANGLE TOPS W/ HALF DONUT TOP

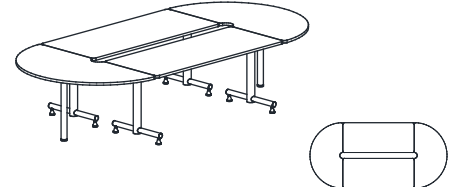

18. RECTANGLE TOPS W/ HALF DONUT TOPS

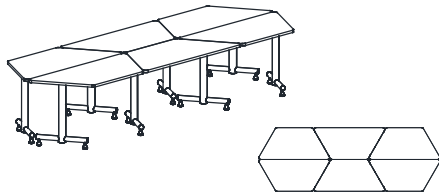

19. TRAPEZOID TOPS

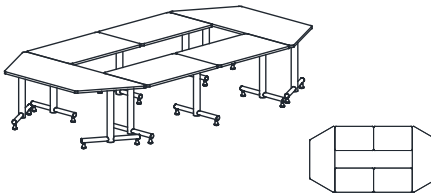

20. RECTANGLE TOPS W/ TRAPEZOID TOPS

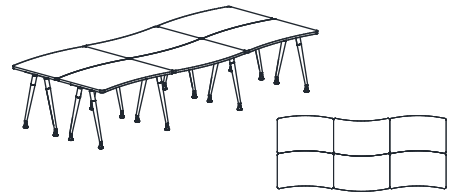

21. WAVE TOPS

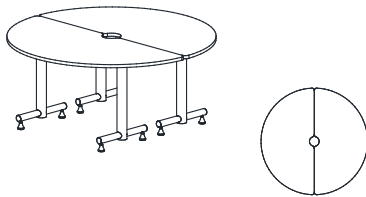

22. HALF DONUT TOPS

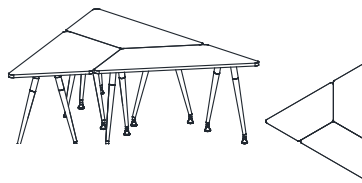

23. TRAPEZOID TOPS

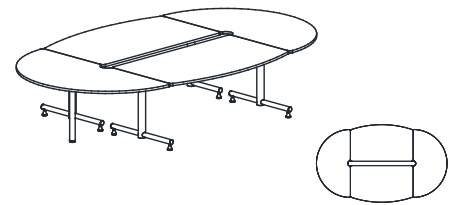

24. RECTANGLE BOWED TOPS W/ HALF DONUT TOPS

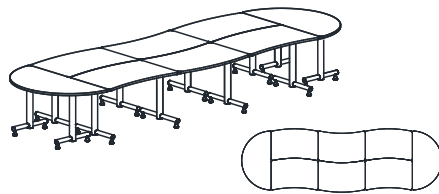

25. WAVE TOPS W/ HALF MOON TOPS

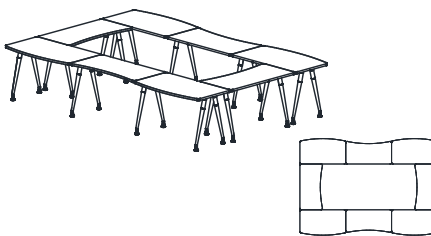

26. RECTANGLE SCOOPED W/ RECTANGLE BOWED TOPS

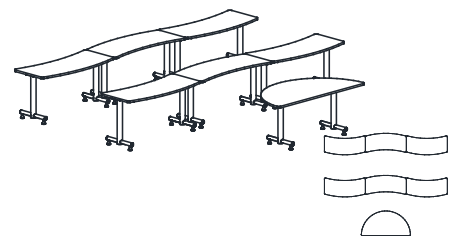

27. WAVE TOPS W/ HALF MOON TOP

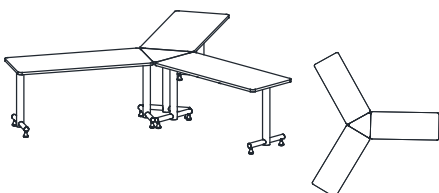

28. RECTANGLE TOPS W/ TRIANGLE TOP

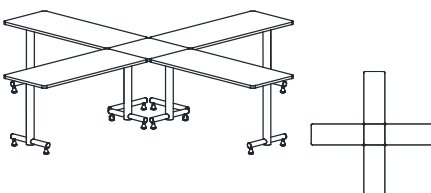

29. RECTANGLE TOPS W/ SQUARE TOP

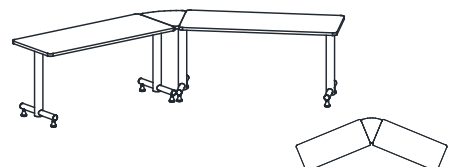

30. RECTANGLE TOPS W/ WEDGE TOP

TOPS CAN BE COMBINED WITH ANY OF THE TABLE BASES AVAILABLE FOR THE FLEX SERIES.  
COMBINATIONS ARE NOT LIMITED TO THE OPTIONS SHOWN. CONTACT CUSTOMER SERVICE FOR MORE OPTIONS.  
FOR TABLE BASE COMPATIBILITY- REFER PAGE **FLX-8 - FLX-9**, 'FLEX SERIES LAMINATE TABLE TOP & BASE CHART'.

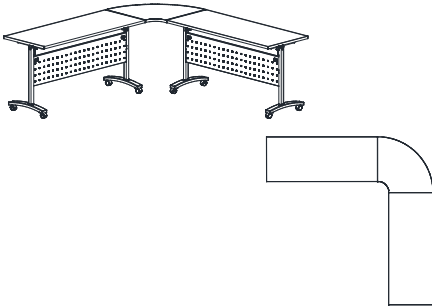

**TUCANA BASE LAYOUT #1**

|                     |  |    |                |
|---------------------|--|----|----------------|
| <b>TU-97L-7220</b>  | TRAINING TABLE BASE FOR 60" & 72" TOPS | X2 | <b>\$453</b>   |
| <b>FLXS-REC2460</b> | 24" RECTANGLE TOPS                     | X2 | <b>\$337</b>   |
| <b>FLXS-QD24</b>    | QUARTER DONUT TOPS                     |    | <b>\$271</b>   |
| TOTAL               |  |    | <b>\$1,851</b> |

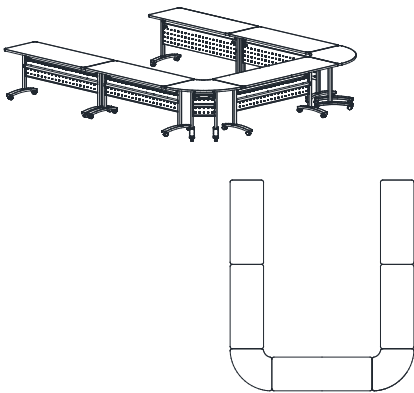

**TUCANA BASE LAYOUT #2**

|                    |   |    |                |
|--------------------|---|----|----------------|
| <b>TU-97L-7220</b> | TRAINING TABLE BASE FOR 60" & 72" TOPS        | X5 | <b>\$453</b>   |
| <b>TU-97L-1520</b> | TRAINING TABLE BASE FOR 30" QUARTER ROUND TOP | X2 | <b>\$218</b>   |
| <b>FLX-REC2460</b> | 24" RECTANGLE TOPS                            | X4 | <b>\$358</b>   |
| <b>FLX-QD24</b>    | QUARTER DONUT TOPS                            | X2 | <b>\$285</b>   |
| <b>FLX-REC2472</b> | 24" RECTANGLE TOPS                            |    | <b>\$416</b>   |
| TOTAL              |   |    | <b>\$5,119</b> |

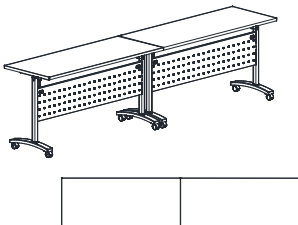

**TUCANA BASE LAYOUT #3**

|                     |  |    |                |
|---------------------|--|----|----------------|
| <b>TU-97L-7220</b>  | TRAINING TABLE BASE FOR 60" & 72" TOPS | X2 | <b>\$453</b>   |
| <b>FLXS-REC2460</b> | 24" RECTANGLE TOPS                     | X2 | <b>\$337</b>   |
| TOTAL               |  |    | <b>\$1,580</b> |

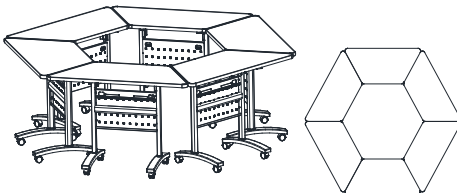

**TUCANA BASE LAYOUT #4**

|                    |                     |    |                |
|--------------------|---------------------|----|----------------|
| <b>TU-97L-2420</b> | TRAINING TABLE BASE | X6 | <b>\$286</b>   |
| <b>FLX-TP2448</b>  | TRAPEZOID TOPS      | X6 | <b>\$201</b>   |
| TOTAL              |                     |    | <b>\$2,922</b> |

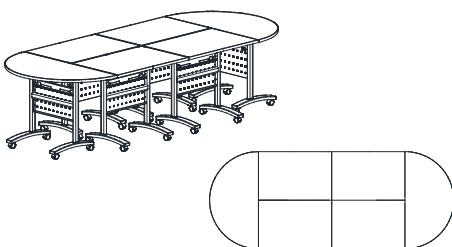

**TUCANA BASE LAYOUT #5**

|                     |   |    |                |
|---------------------|---|----|----------------|
| <b>TU-97L-5420</b>  | TRAINING TABLE BASE FOR 54" & 60" TOPS        | X4 | <b>\$351</b>   |
| <b>TU-97L-1520</b>  | TRAINING TABLE BASE FOR 30" QUARTER ROUND TOP | X2 | <b>\$218</b>   |
| <b>FLXS-HM2448</b>  | HALF MOON TOPS                                | X2 | <b>\$300</b>   |
| <b>FLXS-REC2448</b> | 24" RECTANGLE TOPS                            | X4 | <b>\$246</b>   |
| TOTAL               |   |    | <b>\$3,424</b> |

TOPS CAN BE COMBINED WITH ANY OF THE TABLE BASES AVAILABLE FOR THE FLEX SERIES.  
COMBINATIONS ARE NOT LIMITED TO THE OPTIONS SHOWN. CONTACT CUSTOMER SERVICE FOR MORE OPTIONS.  
FOR TABLE BASE COMPATIBILITY- REFER PAGE [FLX-8](#) - [FLX-9](#), 'FLEX SERIES LAMINATE TABLE TOP & BASE CHART'.

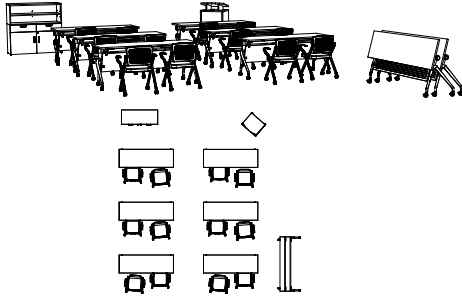

**TUCANA ELITE BASE LAYOUT #6**

|                       |  |    |                 |
|-----------------------|--|----|-----------------|
| <b>FLXS-REC2472</b>   | RECTANGLE FLEX TOP                       | X8 | <b>\$392</b>    |
| <b>TU-98B-72</b>      | 72" TUCANA ELITE BASE                    | X8 | <b>\$785</b>    |
| <b>950-4824LEC</b>    | LECTERN WITH ADJUSTABLE ANGLED TOP       |    | <b>\$1,136</b>  |
| <b>388-1936DCX</b>    | CABINET - DRAWERS OVER DOORS - NO TOP    |    | <b>\$1,248</b>  |
| <b>388-1936SBK-19</b> | STACKING BOOKCASE                        |    | <b>\$776</b>    |
| <b>MES-GR</b>         | MESA PREMIUM TRAINING CHAIR - QUANTITY 2 | X6 | <b>\$1065</b>   |
| TOTAL                 |  |    | <b>\$18,966</b> |



**TUCANA ELITE BASE LAYOUT #7**

|                     |  |    |                |
|---------------------|--|----|----------------|
| <b>FLXS-REC2442</b> | RECTANGLE FLEX TOP                     | X4 | <b>\$225</b>   |
| <b>TU-98B-30</b>    | 30" TUCANA ELITE BASE                  | X4 | <b>\$661</b>   |
| <b>ZUM-MB</b>       | ZUMA TABLE HEIGHT CHAIR- SOLD IN QTY 4 |    | <b>\$1060</b>  |
| TOTAL               |  |    | <b>\$4,604</b> |

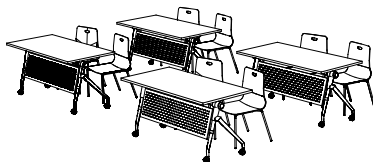
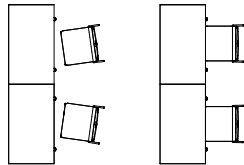

**TUCANA ELITE BASE LAYOUT #8**

|                     |  |    |                |
|---------------------|--|----|----------------|
| <b>FLXS-REC3060</b> | RECTANGLE FLEX TOP                     | X4 | <b>\$384</b>   |
| <b>TU-98B-60</b>    | 60" TUCANA ELITE BASE                  | X4 | <b>\$720</b>   |
| <b>ZUM-MB</b>       | ZUMA TABLE HEIGHT CHAIR- SOLD IN QTY 4 | X2 | <b>\$1060</b>  |
| TOTAL               |  |    | <b>\$6,536</b> |

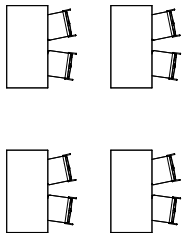

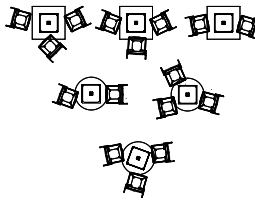

**FLEX LAYOUT #31 - SQUARE BASE**

|                     |                                 |    |                |
|---------------------|---------------------------------|----|----------------|
| <b>900-SQB20</b>    | SQUARE METAL BASE               | X3 | <b>\$474</b>   |
| <b>900-SQB20BAR</b> | BAR HEIGHT SQUARE METAL BASE    | X3 | <b>\$538</b>   |
| <b>FLXS-SQ3636</b>  | SQUARE TOP                      | X3 | <b>\$311</b>   |
| <b>FLXS-R36</b>     | ROUND TOP                       | X3 | <b>\$328</b>   |
| <b>ZUM-MB</b>       | ZUMA TABLE HEIGHT CHAIR - QTY 4 | X2 | <b>\$1060</b>  |
| <b>ZUM-BAR</b>      | ZUMA BAR HEIGHT CHAIR - QTY 4   | X2 | <b>\$1328</b>  |
| TOTAL               |                                 |    | <b>\$9,729</b> |

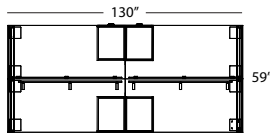
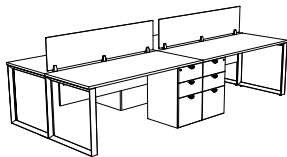

**FLEX LAYOUT #32 - LOOP LEGS**

|                      |  |    |                |
|----------------------|--|----|----------------|
| <b>FLXS-REC3066</b>  | 30" RECTANGLE TOPS                     | X4 | <b>\$414</b>   |
| <b>900-LOOP30</b>    | 30" METAL LOOP LEG                     | X4 | <b>\$207</b>   |
| <b>388-19FPUFX</b>   | FREESTANDING PEDESTAL - NO TOP         | X4 | <b>\$871</b>   |
| <b>TM1-1566TBP</b>   | 15" TOP MOUNT TACK BOARD PRIVACY PANEL | X2 | <b>\$713</b>   |
| <b>CAL-MP1666PLX</b> | 16" PLEXIGLASS HANGING MODESTY PANEL   | X2 | <b>\$511</b>   |
| TOTAL                |  |    | <b>\$8,416</b> |

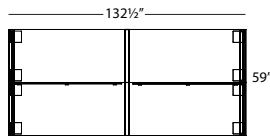
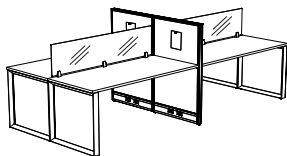

**FLEX LAYOUT #33 - LOOP LEGS**

**HML COMPONENTS**

|                     |  |    |              |
|---------------------|--|----|--------------|
| <b>FLXS-REC3066</b> | 30" RECTANGLE TOPS                     | X4 | <b>\$414</b> |
| <b>900-LOOP30</b>   | 30" METAL LOOP LEG                     | X4 | <b>\$207</b> |
| <b>TM1-1566PLX</b>  | 15" TOP MOUNT PLEXIGLASS PRIVACY PANEL | X2 | <b>\$546</b> |

**HDL COMPONENTS**

|                  |                            |    |              |
|------------------|----------------------------|----|--------------|
| <b>FRM-3048P</b> | 48" TALL PANEL             | X2 | <b>\$413</b> |
| <b>FRM-48PET</b> | PANEL END TRIM             | X2 | <b>\$29</b>  |
| <b>FRM-PCK</b>   | PANEL CONNECTING KIT       |    | <b>\$40</b>  |
| <b>100-WSCK</b>  | WORKSURFACE CONNECTING KIT | X2 | <b>\$25</b>  |
| <b>FRM-WSMK</b>  | WORKSURFACE MOUNTING KIT   |    | <b>\$89</b>  |

TOTAL **\$4,639**

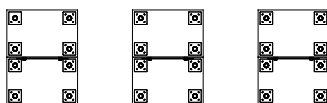
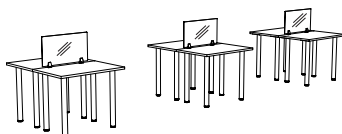

**FLEX LAYOUT #34 - POST LEGS**

|                     |  |     |              |
|---------------------|--|-----|--------------|
| <b>FLXS-REC2436</b> | 24" RECTANGLE TOP                      | X6  | <b>\$204</b> |
| <b>900-RL2.5</b>    | 2 1/2" ROUND LEG                       | X24 | <b>\$96</b>  |
| <b>TM1-1536PLX</b>  | 15" TOP MOUNT PLEXIGLASS PRIVACY PANEL | X3  | <b>\$441</b> |

TOTAL **\$4,851**

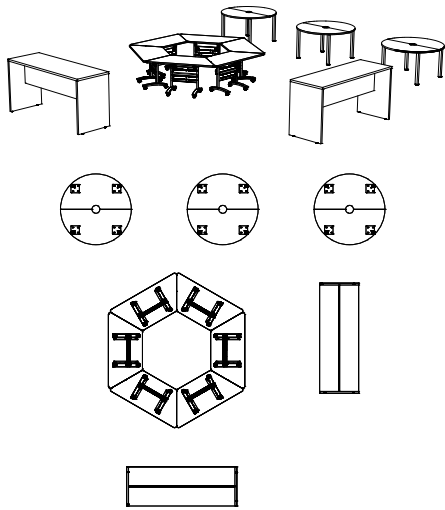

**FLEX LAYOUT #35**

|                       |  |    |                 |
|-----------------------|--|----|-----------------|
| <b>FLXS-HD2454</b>    | HALF DONUT TOPS                          | X6 | <b>\$363</b>    |
| <b>900-SQ2OFFSET</b>  | 2" SQUARE POST LEG WITH OFFSET TOP PLATE | X6 | <b>\$194</b>    |
| <b>FLXS-TP3060</b>    | TRAPEZOID TOP                            | X6 | <b>\$377</b>    |
| <b>TU-97L-2420</b>    | TRAINING TABLE BASE                      | X6 | <b>\$286</b>    |
| <b>388-3084SCT-42</b> | SHARED COMMUNITY TABLE - 42" HIGH        | X2 | <b>\$1,342</b>  |
| TOTAL                 |  |    | <b>\$10,004</b> |

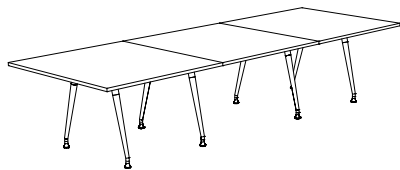

**FLEX LAYOUT #36**

|                      |            |    |                |
|----------------------|------------|----|----------------|
| <b>FLXS-SQ4848</b>   | SQUARE TOP | X3 | <b>\$477</b>   |
| <b>900-SPIDERLEG</b> | SPIDER LEG | X8 | <b>\$103</b>   |
| TOTAL                |            |    | <b>\$2,255</b> |

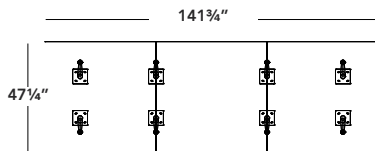

**FLEX LAYOUT #37**

|                      |            |    |                |
|----------------------|------------|----|----------------|
| <b>FLXS-SQ4848</b>   | SQUARE TOP | X2 | <b>\$477</b>   |
| <b>900-SPIDERLEG</b> | SPIDER LEG | X6 | <b>\$103</b>   |
| TOTAL                |            |    | <b>\$1,572</b> |

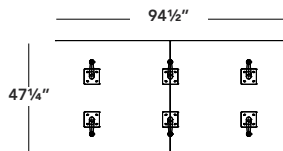

# 900/910/920/950 SERIES

This is a metric series (imperial sizing available). Please refer to page [INDEX-1](#) for details

|  |        |
|--|--------|
| <b>Series Specifications &amp; Description</b> ..... | 900-3  |
| <b>900 Series Table Base Chart</b> .....             | 900-4  |
| <b>Product by Category</b> .....                     |        |
| <b>900 Bases</b> .....                               |        |
| Metal Table Bases & Legs .....                       | 900-8  |
| Laminate Table Bases .....                           | 900-10 |
| Laminate Panel Table Base Sets .....                 | 900-11 |
| Laminate Trestle Panel Base Sets .....               | 900-13 |
| Metal Leg Trestle Panel Base Set .....               | 900-14 |
| Trestle Cube Base Set .....                          | 900-14 |
| Metal Edge Trestle Panel Base Set .....              | 900-15 |
| <b>910/920 Table Tops</b> .....                      |        |
| Stiffener Bars .....                                 | 900-15 |
| Table Tops .....                                     | 900-16 |
| <b>910/920 Complete</b> .....                        |        |
| Upscale Tables .....                                 | 900-19 |
| <b>388/600 Series Tables</b> .....                   |        |
| Bullet Tables .....                                  | 900-21 |
| Wedge Bullet Tables .....                            | 900-22 |
| Shared Community Tables .....                        | 900-24 |
| Magazine Tables .....                                | 900-26 |
| <b>950 Conference Furniture</b> .....                | 900-27 |
| <b>388/600 Storage Benches</b> .....                 | 900-7  |





900 BASES  
910/920 TABLE TOPS  
950 CONFERENCE FURNITURE

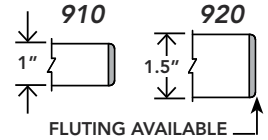

### Features

- ♥ A complete offering of styles and shapes to choose from.
- ♥ Two edge profiles available.
- ♥ Complete assortment of solid colours and woodgrain finishes.
- ♥ Edge colors to match most finishes (see chart below).

### Finishes

#### Laminates

| ABBR | LAMINATE COLOUR      | 900            | 910  |                   | 920  |                   | 950                  |
|------|----------------------|----------------|------|-------------------|------|-------------------|----------------------|
|      |                      | LAMINATE BASES | TOPS | MATCHING 2MM EDGE | TOPS | MATCHING 2MM EDGE | CONFERENCE FURNITURE |
| AM   | Autumn Maple         | ✓              | ✓    | ✓                 | ✓    | ✓                 | ✓                    |
| BL   | Black (base only)    | ✓              | n/a  | ✓                 | n/a  | ✓                 | ✓                    |
| BW   | Black Walnut         | ✓              | ✓    | ✓                 | ✓    | ✓                 | ✓                    |
| CD   | Cappuccino Dream**   | ✓              | ✓    | ✓                 | ✓    | ✓                 | ✓                    |
| CM   | Charcoal Matrix      | ✓              | ✓    | Black             | ✓    | Black             | ✓                    |
| DE   | Desert Sand          | ✓              | ✓    | ✓                 | ✓    | ✓                 | ✓                    |
| DD   | Driftwood***         | ✓ (1")         | ✓    | ✓                 | ✓    | ✓                 | ✓ (1")               |
| DW   | Driftwood Grey**     | ✓ (¾")         | n/a  | ✓                 | n/a  | ✓                 | ✓ (¾")               |
| EZ   | Evening Zen          | ✓              | ✓    | ✓                 | ✓    | ✓                 | ✓                    |
| GA   | Golden Ash           | ✓              | ✓    | ✓                 | ✓    | ✓                 | ✓                    |
| GD   | Grey Dusk            | ✓              | ✓    | ✓                 | ✓    | ✓                 | ✓                    |
| GM   | Grey Matrix          | ✓              | ✓    | Grey              | ✓    | Grey              | ✓                    |
| GR   | Grey                 | ✓              | ✓    | ✓                 | ✓    | ✓                 | ✓                    |
| GT   | Graphite (base only) | ✓              | n/a  | ✓                 | n/a  | ✓                 | ✓                    |
| HM   | Hardrock Maple       | ✓              | ✓    | ✓                 | ✓    | ✓                 | ✓                    |
| NC   | Noce Coca            | ✓              | ✓    | ✓                 | ✓    | ✓                 | ✓                    |
| PW   | Pure White           | ✓              | ✓    | ✓                 | ✓    | ✓                 | ✓                    |
| RM   | Royal Mahogany       | ✓              | ✓    | ✓                 | ✓    | ✓                 | ✓                    |
| SM   | Sugar Maple          | ✓              | ✓    | ✓                 | ✓    | ✓                 | ✓                    |
| SW   | Seaside White        | ✓              | ✓    | ✓                 | ✓    | ✓                 | ✓                    |
| VA   | Volcanic Ash         | ✓              | ✓    | ✓                 | ✓    | ✓                 | ✓                    |
| WW   | Winter Wood          | ✓              | ✓    | ✓                 | ✓    | ✓                 | ✓                    |

\*\*Textured Finish

\*\*\* Non-textured Finish 1" & 1½" only

n/a: Not available

High Pressure (HP) laminate available Contact Customer Service.

### Construction

- ♥ All table tops, bases and furniture are constructed of thermally fused laminate.

### Edge Detail

- ♥ 900 series laminate bases are 1" thick and edged with a matching 2mm edge band for durability.
- ♥ 910 series tops are 1" thick and edged with a matching 2mm edge band for durability.
- ♥ 920 series tops are 1 1/2" thick and edged with a matching 2mm edge band for durability.
- ♥ There is no upcharge for alternate banding changes to a standard Heartwood colour. Simply include your banding colour choice on your PO.
- ♥ **Fluting is available on 920 series tops to match 600 series furniture. PLEASE SPECIFY ON PO (no up-charge).**
- ♥ 950 series conference furniture is 1" & ¾" thick and edged with a matching 2mm edge band for durability.

### Custom Sizes

- ♥ Custom sizes available...call Customer Service for pricing. Please specify quote number when ordering.
- ♥ For simple changes, use the price of the next model size up.
  - > **Ordering Example:** for the price of a **910-RT7234**: Take the price of the next larger size...**910-RT7236 - \$671**

# 900 SERIES TABLE BASE CHART











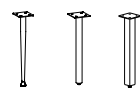

**USE THIS CHART TO DETERMINE CORRECT LAMINATE TABLE TOP & BASE COMBINATIONS.**  
 NOTE: WHEN ORDERING 920 SERIES, SPECIFY EDGE DETAIL (FLUTED OR NON FLUTED)

| <br>910<br><br>920<br>FLUTING AVAILABLE<br>TOP TYPE- REF<br>PGS 900-(9-10) |               | MODEL#         | DIMENSIONS (INCHES) | QTY    | SEATING CAPACITY | CROSS-LAMINATE | CUBE-LAMINATE | DRUM- HP LAMINATE | PANEL-LAMINATE   | MULTIPLE PANEL-LAMINATE | CROSS-METAL  | BAR HEIGHT CROSS-METAL | TEE-METAL |
|--|---------------|----------------|---------------------|--------|------------------|----------------|---------------|-------------------|------------------|-------------------------|--------------|------------------------|-----------|
| <br>ROUND  | -R30          | 29.5           | 1 PC.               | 4      | 1-XB20           | 1-CU16         | 1-DR18        | N/A               | N/A              | 1-CROSS24               | 1-BAR24      | N/A                    |           |
|  | -R36          | 35.5           | 1 PC.               | 4      | 1-XB20           | 1-CU20         | 1-DR18        | N/A               | N/A              | 1-CROSS30               | 1-BAR30      | N/A                    |           |
|  | -R42          | 41.5           | 1 PC.               | 5      | 1-XB26           | 1-CU20         | 1-DR24        | N/A               | N/A              | 1-CROSS30               | 1-BAR30      | N/A                    |           |
|  | -R48          | 47.25          | 1 PC.               | 5      | 1-XB26           | 1-CU24         | 1-DR24        | N/A               | N/A              | 1-CROSS30               | 1-BAR30      | N/A                    |           |
|  | -R54          | 53.25          | 1 PC.               | 6      | 1-XB36           | 1-CU24         | 1-DR30        | N/A               | N/A              | 1-CROSS36               | 1-BAR36      | N/A                    |           |
|  | -R60          | 59             | 1 PC.               | 7      | 1-XB36           | 1-CU30         | 1-DR30        | N/A               | N/A              | 1-CROSS36               | 1-BAR36      | N/A                    |           |
| <br>TEARDROP   | -TD36         | 35.5           | 1 PC.               | 4      | 1-XB20           | 1-CU20         | 1-DR18        | N/A               | N/A              | 1-CROSS24               | 1-BAR24      | 1-TEE24**              |           |
|  | -TD48         | 47.25          | 1 PC.               | 5      | 1-XB26           | 1-CU24         | 1-DR24        | N/A               | N/A              | 1-CROSS30               | 1-BAR30      | 1-TEE30**              |           |
|  | -TD60         | 59             | 1 PC.               | 7      | 1-XB36           | 1-CU30         | 1-DR30        | N/A               | N/A              | 1-CROSS36               | 1-BAR36      | 1-TEE36**              |           |
| <br>RACETRACK  | -RT6030       | 59 X 29.5      | 1 PC.               | 6      | 2-XB20           | 2-CU16         | 2-DR18        | 1-PS60            | N/A              | 2-CROSS24               | 2-BAR24      | 2-TEE30♦               |           |
|  | -RT7230       | 71 X 29.5      | 1 PC.               | 6      | 2-XB20           | 2-CU16         | 2-DR18        | 1-PS72            | N/A              | 2-CROSS24               | 2-BAR24      | 2-TEE30♦♦              |           |
|  | -RT7236       | 71 X 35.5      | 1 PC.               | 6      | 2-XB20           | 2-CU20         | 2-DR18        | 1-PS72            | N/A              | 2-CROSS24               | 2-BAR24      | 2-TEE30♦♦              |           |
|  | -RT8436       | 82.75 X 35.5   | 1 PC.               | 8      | 2-XB20           | 2-CU20         | 2-DR18        | 1-PS84            | N/A              | 2-CROSS24               | 2-BAR24      | 2-TEE30 + 1*           |           |
|  | -RT9644       | 94.5 X 43.5    | 1 PC.               | 8      | 2-XB26           | 2-CU24         | 2-DR18        | 1-PS96            | N/A              | 2-CROSS30               | 2-BAR30      | 2-TEE36 + 1*           |           |
|  | -RT12048      | 118 X 47.25    | 2 PC.               | 10     | 3-XB26           | 3-CU24         | 3-DR24        | N/A               | 1-PS120 (double) | 3-CROSS30               | 3-BAR30      | 3-TEE36♦♦              |           |
|  | -RT14448      | 141.75 X 47.25 | 2 PC.               | 12     | 3-XB26           | 3-CU24         | 3-DR24        | N/A               | 1-PS144 (double) | 3-CROSS30               | 3-BAR30      | 3-TEE36♦♦♦             |           |
|  | -RT15648      | 153.5 X 47.25  | 2 PC.               | 12     | 3-XB26           | 3-CU24         | 3-DR24        | N/A               | 1-PS156 (double) | 3-CROSS30               | 3-BAR30      | 3-TEE36 + 2*           |           |
|  | -RT16848      | 165.5 X 47.25  | 2 PC.               | 12     | 3-XB26           | 3-CU24         | 3-DR24        | N/A               | 1-PS168 (double) | 3-CROSS30               | 3-BAR30      | 3-TEE36 + 2*           |           |
|  | -RT19248      | 189 X 47.25    | 2 PC.               | 14     | 3-XB26           | 3-CU24         | 3-DR24        | N/A               | 1-PS192 (double) | 3-CROSS30               | 3-BAR30      | 3-TEE36 + 2*           |           |
|  | -RT21648      | 212.75 X 47.25 | 3 PC                | 16     | 4-XB26           | 3-CU24         | 4-DR24        | N/A               | 1-PS216 (triple) | 4-CROSS30               | 4-BAR30      | 4-TEE36 + 3*           |           |
|  | -RT24048      | 236.25 X 47.25 | 3 PC                | 18     | 4-XB26           | 3-CU24         | 4-DR24        | N/A               | 1-PS240 (triple) | 4-CROSS30               | 4-BAR30      | 4-TEE36 + 3*           |           |
| -RT26448   | 260 X 47.25   | 3 PC           | 20                  | 5-XB26 | 3-CU24           | 4-DR24         | N/A           | 1-PS264 (triple)  | 5-CROSS30        | 5-BAR30                 | 4-TEE36 + 3* |                        |           |
| -RT28848   | 283.5 X 47.25 | 3 PC           | 22                  | 5-XB26 | 3-CU24           | 4-DR24         | N/A           | 1-PS288 (triple)  | 5-CROSS30        | 5-BAR30                 | 4-TEE36 + 3* |                        |           |
| <br>RECTANGLE  | -REC6030      | 59 X 29.5      | 1 PC.               | 6      | 2-XB20           | 2-CU16         | 2-DR18        | 1-PS60            | N/A              | 2-CROSS24               | 2-BAR24      | 2-TEE30♦               |           |
|  | -REC7230      | 71 X 29.5      | 1 PC.               | 6      | 2-XB20           | 2-CU16         | 2-DR18        | 1-PS72            | N/A              | 2-CROSS24               | 2-BAR24      | 2-TEE30♦♦              |           |
|  | -REC7236      | 71 X 35.5      | 1 PC.               | 6      | 2-XB20           | 2-CU20         | 2-DR18        | 1-PS72            | N/A              | 2-CROSS24               | 2-BAR24      | 2-TEE30♦♦              |           |
|  | -REC8436      | 82.75 X 35.5   | 1 PC.               | 8      | 2-XB20           | 2-CU20         | 2-DR18        | 1-PS84            | N/A              | 2-CROSS24               | 2-BAR24      | 2-TEE30 + 1*           |           |
|  | -REC9644      | 94.5 X 43.5    | 1 PC.               | 8      | 2-XB26           | 2-CU24         | 2-DR18        | 1-PS96            | N/A              | 2-CROSS30               | 2-BAR30      | 2-TEE36 + 1*           |           |
|  | -REC12048     | 118 X 47.25    | 2 PC.               | 10     | 3-XB26           | 3-CU24         | 3-DR24        | N/A               | 1-PS120          | 3-CROSS30               | 3-BAR30      | 3-TEE36♦♦              |           |
|  | -REC14448     | 141.75 X 47.25 | 2 PC.               | 12     | 3-XB26           | 3-CU24         | 3-DR24        | N/A               | 1-PS144          | 3-CROSS30               | 3-BAR30      | 3-TEE36♦♦♦             |           |
|  | -REC15648     | 153.5 X 47.25  | 2 PC.               | 12     | 3-XB26           | 3-CU24         | 3-DR24        | N/A               | 1-PS156          | 3-CROSS30               | 3-BAR30      | 3-TEE36 + 2*           |           |
|  | -REC16848     | 165.5 X 47.25  | 2 PC.               | 12     | 3-XB26           | 3-CU24         | 3-DR24        | N/A               | 1-PS168          | 3-CROSS30               | 3-BAR30      | 3-TEE36 + 2*           |           |
|  | -REC19248     | 189 X 47.25    | 2 PC.               | 14     | 3-XB26           | 3-CU24         | 3-DR24        | N/A               | 1-PS192          | 3-CROSS30               | 3-BAR30      | 3-TEE36 + 2*           |           |
|  | -REC21648     | 212.75 X 47.25 | 3 PC                | 16     | 4-XB26           | 4-CU24         | 4-DR24        | N/A               | 1-PS216          | 4-CROSS30               | 4-BAR30      | 4-TEE36 + 3*           |           |
|  | -REC24048     | 236.25 X 47.25 | 3 PC                | 18     | 4-XB26           | 4-CU24         | 4-DR24        | N/A               | 1-PS240          | 4-CROSS30               | 4-BAR30      | 4-TEE36 + 3*           |           |
| -REC26448  | 260 X 47.25   | 3 PC           | 20                  | 5-XB26 | 4-CU24           | 4-DR24         | N/A           | 1-PS264           | 5-CROSS30        | 5-BAR30                 | 4-TEE36 + 3* |                        |           |
| -REC28848  | 283.5 X 47.25 | 3 PC           | 22                  | 5-XB26 | 4-CU24           | 4-DR24         | N/A           | 1-PS288           | 5-CROSS30        | 5-BAR30                 | 4-TEE36 + 3* |                        |           |

\* QUANTITY OF CENTER SUPPORTS REQUIRED. CONTACT CUSTOMER SERVICE FOR INFO  
 \*\* REQUIRES SQUARE END OF TEARDROP TO BE BRACKETED TO ADJOINING UNIT OTHERWISE, 2 LEGS REQUIRED.

♦ ONE (1) STIFFENER BAR IS RECOMMENDED. SEE PAGE 900-15.  
 ♦♦ TWO (2) STIFFENER BARS ARE RECOMMENDED. SEE PAGE 900-15.  
 ♦♦♦ FOUR (4) STIFFENER BARS ARE RECOMMENDED. SEE PAGE 900-15.

USE THIS CHART TO DETERMINE CORRECT LAMINATE TABLE TOP & BASE COMBINATIONS.  
NOTE: WHEN ORDERING 920 SERIES, SPECIFY EDGE DETAIL (FLUTED OR NON FLUTED)

| TOP TYPE- REF<br>PGS 900-(9-10)   | MODEL#    |  SPIDER-<br>METAL |  TAPER, 2.5" ROUND<br>OR SQUARE LEG |  2" SQUARE<br>LEG -OFFSET<br>(2-PACK) |  4.75"<br>ROUND-<br>METAL |  SQUARE/ROUND<br>METAL BASE<br>COFFEE TABLE<br>HEIGHT |  SQUARE/ROUND<br>METAL BASE |  SQUARE/ROUND<br>METAL BASE<br>BAR HEIGHT |  METAL LOOP<br>LEGS |  ELECTRIC<br>HEIGHT<br>ADJUSTABLE |
|---|-----------|--|--|--|--|---|--|--|--|--|
|    | -R30      | 4-SPIDERLEG  | 4-TAPERLEG/RL2.5/SQ3   | 2-SQ2OFFSET  | 4-RL5  | 1-SQB20CFT/<br>1-ROU20CFT   | 1-SQB20/<br>1-ROU20  | 1-SQB20BAR/<br>1-ROU20BAR  | N/A  | N/A  |
|   | -R36      | 4-SPIDERLEG  | 4-TAPERLEG/RL2.5/SQ3   | 2-SQ2OFFSET  | 4-RL5  | 1-SQB20CFT/<br>1-ROU20CFT   | 1-SQB20/<br>1-ROU20  | 1-SQB20BAR/<br>1-ROU20BAR  | N/A  | N/A  |
|   | -R42      | 4-SPIDERLEG  | 4-TAPERLEG/RL2.5/SQ3   | 2-SQ2OFFSET  | 4-RL5  | 1-SQB20CFT/<br>1-ROU20CFT   | 1-SQB20/<br>1-ROU20  | N/A  | N/A  | N/A  |
|   | -R48      | 4-SPIDERLEG♦   | 4-TAPERLEG/RL2.5/SQ3♦  | 2-SQ2OFFSET  | 4-RL5♦   | N/A   | N/A  | N/A  | N/A  | N/A  |
|   | -R54      | 4-SPIDERLEG♦   | 4-TAPERLEG/RL2.5/SQ3♦  | 2-SQ2OFFSET  | 4-RL5♦   | N/A   | N/A  | N/A  | N/A  | N/A  |
|   | -R60      | 4-SPIDERLEG♦   | 4-TAPERLEG/RL2.5/SQ3♦  | 2-SQ2OFFSET  | 4-RL5♦   | N/A   | N/A  | N/A  | N/A  | N/A  |
|    | -TD36     | 1-SPIDERLEG**  | 1-TAPERLEG/RL2.5/SQ3**   | 1-SQ2OFFSET  | 1-RL5**  | 1-SQB20CFT/<br>1-ROU20CFT   | 1-SQB20/<br>1-ROU20  | 1-SQB20BAR/<br>1-ROU20BAR  | N/A  | N/A  |
|   | -TD48     | 1-SPIDERLEG**  | 1-TAPERLEG/RL2.5/SQ3**   | 1-SQ2OFFSET  | 1-RL5**  | 1-SQB20CFT**/<br>1-ROU20CFT**   | 1-SQB20**/<br>1-ROU20**  | 1-SQB20BAR**/<br>1-ROU20BAR**  | N/A  | N/A  |
|   | -TD60     | 1-SPIDERLEG**  | 1-TAPERLEG/RL2.5/SQ3**   | 1-SQ2OFFSET  | 1-RL5**  | 1-SQB20CFT**/<br>1-ROU20CFT**   | 1-SQB20**/<br>1-ROU20**  | 1-SQB20BAR**/<br>1-ROU20BAR**  | N/A  | N/A  |
|    | -RT6030   | 4-SPIDERLEG♦   | 4-TAPERLEG/RL2.5/SQ3♦  | 2-SQ2OFFSET  | 4-RL5♦   | 2-SQB20CFT/<br>2-ROU20CFT   | 2-SQB20/<br>2-ROU20  | 2-SQB20BAR/<br>2-ROU20BAR  | 2-LOOP30♦  | 1-E1-60  |
|   | -RT7230   | 4-SPIDERLEG♦♦  | 4-TAPERLEG/RL2.5/SQ3♦♦   | 2-SQ2OFFSET  | 4-RL5♦♦  | 2-SQB20CFT/<br>2-ROU20CFT   | 2-SQB20/<br>2-ROU20  | 2-SQB20BAR/<br>2-ROU20BAR  | 2-LOOP30♦♦   | 1-E1-72  |
|   | -RT7236   | 4-SPIDERLEG♦♦  | 4-TAPERLEG/RL2.5/SQ3♦♦   | 2-SQ2OFFSET  | 4-RL5♦♦  | 2-SQB20CFT/<br>2-ROU20CFT   | 2-SQB20/<br>2-ROU20  | 2-SQB20BAR/<br>2-ROU20BAR  | 2-LOOP30♦♦   | 1-E1-72  |
|   | -RT8436   | 4-SPIDERLEG + 1*   | 5-TAPERLEG/RL2.5/SQ3   | 3-SQ2OFFSET  | 5-RL5  | 2-SQB20CFT/<br>2-ROU20CFT   | 2-SQB20/<br>2-ROU20  | 2-SQB20BAR/<br>2-ROU20BAR  | 3-LOOP30   | 1-E1-84  |
|   | -RT9644   | 4-SPIDERLEG + 1*   | 5-TAPERLEG/RL2.5/SQ3   | 3-SQ2OFFSET  | 5-RL5  | 2-SQB20CFT♦♦/<br>2-ROU20CFT♦♦   | 2-SQB20♦♦/<br>2-ROU20♦♦  | N/A  | N/A  | 1-E1-96  |
|   | -RT12048  | 6-SPIDERLEG♦♦  | 6-TAPERLEG/RL2.5/SQ3♦♦   | 3-SQ2OFFSET  | 6-RL5♦♦  | 3-SQB20CFT/<br>3-ROU20CFT   | 3-SQB20/<br>3-ROU20  | N/A  | N/A  | N/A  |
|   | -RT14448  | 6-SPIDERLEG♦♦♦♦  | 6-TAPERLEG/RL2.5/SQ3♦♦♦♦   | 3-SQ2OFFSET  | 6-RL5♦♦♦♦  | 3-SQB20CFT/<br>3-ROU20CFT   | 3-SQB20/<br>3-ROU20  | N/A  | N/A  | N/A  |
|   | -RT15648  | 6-SPIDERLEG + 2*   | 8-TAPERLEG/RL2.5/SQ3   | 4-SQ2OFFSET  | 8-RL5  | 3-SQB20CFT♦♦♦♦/<br>3-ROU20CFT♦♦♦♦   | 3-SQB20♦♦♦♦/<br>3-ROU20♦♦♦♦  | N/A  | N/A  | N/A  |
|   | -RT16848  | 6-SPIDERLEG + 2*   | 8-TAPERLEG/RL2.5/SQ3   | 4-SQ2OFFSET  | 8-RL5  | 3-SQB20CFT♦♦♦♦/<br>3-ROU20CFT♦♦♦♦   | 3-SQB20♦♦♦♦/<br>3-ROU20♦♦♦♦  | N/A  | N/A  | N/A  |
|   | -RT19248  | 6-SPIDERLEG + 2*   | 8-TAPERLEG/RL2.5/SQ3   | 4-SQ2OFFSET  | 8-RL5  | 4-SQB20CFT/<br>4-ROU20CFT   | 4-SQB20/<br>4-ROU20  | N/A  | N/A  | N/A  |
|   | -RT21648  | 8-SPIDERLEG + 3*   | 11-TAPERLEG/RL2.5/SQ3  | 6-SQ2OFFSET  | 11-RL5   | 6-SQB20CFT/<br>6-ROU20CFT   | 6-SQB20/<br>6-ROU20  | N/A  | N/A  | N/A  |
|   | -RT24048  | 8-SPIDERLEG + 3*   | 11-TAPERLEG/RL2.5/SQ3  | 6-SQ2OFFSET  | 11-RL5   | 6-SQB20CFT/<br>6-ROU20CFT   | 6-SQB20/<br>6-ROU20  | N/A  | N/A  | N/A  |
|   | -RT26448  | 8-SPIDERLEG + 3*   | 11-TAPERLEG/RL2.5/SQ3  | 6-SQ2OFFSET  | 11-RL5   | 6-SQB20CFT/<br>6-ROU20CFT   | 6-SQB20/<br>6-ROU20  | N/A  | N/A  | N/A  |
|   | -RT28848  | 8-SPIDERLEG + 3*   | 11-TAPERLEG/RL2.5/SQ3  | 6-SQ2OFFSET  | 11-RL5   | 6-SQB20CFT/<br>6-ROU20CFT   | 6-SQB20/<br>6-ROU20  | N/A  | N/A  | N/A  |
|  | -REC6030  | 4-SPIDERLEG♦   | 4-TAPERLEG/RL2.5/SQ3♦  | 2-SQ2OFFSET  | 4-RL5♦   | 2-SQB20CFT/<br>2-ROU20CFT   | 2-SQB20/<br>2-ROU20  | 2-SQB20BAR/<br>2-ROU20BAR  | 2-LOOP30♦  | 1-E1-60  |
|   | -REC7230  | 4-SPIDERLEG♦♦  | 4-TAPERLEG/RL2.5/SQ3♦♦   | 2-SQ2OFFSET  | 4-RL5♦♦  | 2-SQB20CFT/<br>2-ROU20CFT   | 2-SQB20/<br>2-ROU20  | 2-SQB20BAR/<br>2-ROU20BAR  | 2-LOOP30♦♦   | 1-E1-72  |
|   | -REC7236  | 4-SPIDERLEG♦♦  | 4-TAPERLEG/RL2.5/SQ3♦♦   | 2-SQ2OFFSET  | 4-RL5♦♦  | 2-SQB20CFT/<br>2-ROU20CFT   | 2-SQB20/<br>2-ROU20  | 2-SQB20BAR/<br>2-ROU20BAR  | 2-LOOP30♦♦   | 1-E1-72  |
|   | -REC8436  | 4-SPIDERLEG + 1*   | 5-TAPERLEG/RL2.5/SQ3   | 3-SQ2OFFSET  | 5-RL5  | 2-SQB20CFT/<br>2-ROU20CFT   | 2-SQB20/<br>2-ROU20  | 2-SQB20BAR/<br>2-ROU20BAR  | 3-LOOP30   | 1-E1-84  |
|   | -REC9644  | 4-SPIDERLEG + 1*   | 5-TAPERLEG/RL2.5/SQ3   | 3-SQ2OFFSET  | 5-RL5  | 2-SQB20CFT♦♦/<br>2-ROU20CFT♦♦   | 2-SQB20♦♦/<br>2-ROU20♦♦  | N/A  | N/A  | 1-E1-96  |
|   | -REC12048 | 6-SPIDERLEG♦♦  | 6-TAPERLEG/RL2.5/SQ3♦♦   | 3-SQ2OFFSET  | 6-RL5♦♦  | 3-SQB20CFT/<br>3-ROU20CFT   | 3-SQB20/<br>3-ROU20  | N/A  | N/A  | N/A  |
|   | -REC14448 | 6-SPIDERLEG♦♦♦♦  | 6-TAPERLEG/RL2.5/SQ3♦♦♦♦   | 3-SQ2OFFSET  | 6-RL5♦♦♦♦  | 3-SQB20CFT/<br>3-ROU20CFT   | 3-SQB20/<br>3-ROU20  | N/A  | N/A  | N/A  |
|   | -REC15648 | 6-SPIDERLEG + 2*   | 8-TAPERLEG/RL2.5/SQ3   | 4-SQ2OFFSET  | 8-RL5  | 3-SQB20CFT♦♦♦♦/<br>3-ROU20CFT♦♦♦♦   | 3-SQB20♦♦♦♦/<br>3-ROU20♦♦♦♦  | N/A  | N/A  | N/A  |
|   | -REC16848 | 6-SPIDERLEG + 2*   | 8-TAPERLEG/RL2.5/SQ3   | 4-SQ2OFFSET  | 8-RL5  | 3-SQB20CFT♦♦♦♦/<br>3-ROU20CFT♦♦♦♦   | 3-SQB20♦♦♦♦/<br>3-ROU20♦♦♦♦  | N/A  | N/A  | N/A  |
|   | -REC19248 | 6-SPIDERLEG + 2*   | 8-TAPERLEG/RL2.5/SQ3   | 4-SQ2OFFSET  | 8-RL5  | 4-SQB20CFT/<br>4-ROU20CFT   | 4-SQB20/<br>4-ROU20  | N/A  | N/A  | N/A  |
|   | -REC21648 | 8-SPIDERLEG + 3*   | 11-TAPERLEG/RL2.5/SQ3  | 6-SQ2OFFSET  | 11-RL5   | 6-SQB20CFT/<br>6-ROU20CFT   | 6-SQB20/<br>6-ROU20  | N/A  | N/A  | N/A  |
|   | -REC24048 | 8-SPIDERLEG + 3*   | 11-TAPERLEG/RL2.5/SQ3  | 6-SQ2OFFSET  | 11-RL5   | 6-SQB20CFT/<br>6-ROU20CFT   | 6-SQB20/<br>6-ROU20  | N/A  | N/A  | N/A  |
|   | -REC26448 | 8-SPIDERLEG + 3*   | 11-TAPERLEG/RL2.5/SQ3  | 6-SQ2OFFSET  | 11-RL5   | 6-SQB20CFT/<br>6-ROU20CFT   | 6-SQB20/<br>6-ROU20  | N/A  | N/A  | N/A  |
|   | -REC28848 | 8-SPIDERLEG + 3*   | 11-TAPERLEG/RL2.5/SQ3  | 6-SQ2OFFSET  | 11-RL5   | 6-SQB20CFT/<br>6-ROU20CFT   | 6-SQB20/<br>6-ROU20  | N/A  | N/A  | N/A  |

\* QUANTITY OF CENTER SUPPORTS REQUIRED. CONTACT CUSTOMER SERVICE FOR INFO  
\*\* REQUIRES SQUARE END OF TEARDROP TO BE BRACKETED TO ADJOINING UNIT  
OTHERWISE, 2 LEGS REQUIRED.

♦ ONE (1) STIFFENER BAR IS RECOMMENDED. SEE PAGE 900-15.  
♦♦ TWO (2) STIFFENER BARS ARE RECOMMENDED. SEE PAGE 900-15.  
♦♦♦♦ FOUR (4) STIFFENER BARS ARE RECOMMENDED. SEE PAGE 900-15.

# 900 SERIES TABLE BASE CHART

**USE THIS CHART TO DETERMINE CORRECT LAMINATE TABLE TOP & BASE COMBINATIONS.**  
 NOTE: WHEN ORDERING 920 SERIES, SPECIFY EDGE DETAIL (FLUTED OR NON FLUTED)

|                              |            | DIMENSIONS (INCHES) | QTY   | SEATING CAPACITY | <br>CROSS-LAMINATE | <br>CUBE-LAMINATE | <br>DRUM- HP LAMINATE | <br>PANEL-LAMINATE | <br>MULTIPLE PAN- EL- LAMINATE | <br>CROSS-METAL | <br>BAR HEIGHT CROSS-METAL | <br>TEE-METAL |
|------------------------------|------------|---------------------|-------|------------------|--------------------|-------------------|-----------------------|--------------------|--------------------------------|-----------------|----------------------------|---------------|
| TOP TYPE- REF PGS 900-(9-10) | MODEL#     |                     |       |                  |                    |                   |                       |                    |                                |                 |                            |               |
|                              | -B7236/27  | 71 X 35.5           | 1 PC. | 6                | 2-XB20             | 2-CU16            | 2-DR18                | 1-PS72             | N/A                            | 2-CROSS24       | 2-BAR24                    | 2-TEE30◆      |
|                              | -B8436/27  | 82.75 X 35.5        | 1 PC. | 8                | 2-XB20             | 2-CU16            | 2-DR18                | 1-PS84             | N/A                            | 2-CROSS24       | 2-BAR24                    | 2-TEE30 + 1*  |
|                              | -B9644/30  | 94.5 X 43.5         | 1 PC. | 8                | 2-XB26             | 2-CU16            | 2-DR18                | 1-PS96             | N/A                            | 2-CROSS30       | 2-BAR30                    | 2-TEE36 + 1*  |
|                              | -B12048/30 | 118 X 47.25         | 2 PC. | 10               | 2-XB20 & 1-XB26    | 2-CU16 & 1-CU24   | 2-DR18 & 1-DR24       | N/A                | 1-PS120 (double)               | 3-CROSS30       | 3-BAR30                    | 3-TEE36◆◆     |
|                              | -B14448/30 | 141.75 X 47.25      | 2 PC. | 12               | 2-XB20 & 1-XB26    | 2-CU16 & 1-CU24   | 2-DR18 & 1-DR24       | N/A                | 1-PS144 (double)               | 3-CROSS30       | 3-BAR30                    | 3-TEE36◆◆◆    |
| <br>BOAT                     | -B15648/30 | 153.5 X 47.25       | 2 PC. | 12               | 2-XB20 & 1-XB26    | 2-CU16 & 1-CU24   | 2-DR18 & 1-DR24       | N/A                | 1-PS156 (double)               | 3-CROSS30       | 3-BAR30                    | 3-TEE36 + 2*  |
|                              | -B16848/30 | 165.5 X 47.25       | 2 PC. | 12               | 2-XB20 & 1-XB26    | 2-CU16 & 1-CU24   | 2-DR18 & 1-DR24       | N/A                | 1-PS168 (double)               | 3-CROSS30       | 3-BAR30                    | 3-TEE36 + 2*  |
|                              | -B19248/30 | 189 X 47.25         | 2 PC. | 14               | 2-XB20 & 1-XB26    | 2-CU16 & 1-CU24   | 2-DR18 & 1-DR24       | N/A                | 1-PS192 (double)               | 3-CROSS30       | 3-BAR30                    | 3-TEE36 + 2*  |
|                              | -B21648/30 | 212.75 X 47.25      | 3 PC  | 16               | 2-XB20 & 2-XB26    | 2-CU16 & 2-CU24   | 2-DR18 & 2-DR24       | N/A                | 1-PS216 (triple)               | 4-CROSS30       | 4-BAR30                    | 4-TEE36 + 3*  |
|                              | -B24048/30 | 236.25 X 47.25      | 3 PC  | 18               | 2-XB20 & 2-XB26    | 2-CU16 & 2-CU24   | 2-DR18 & 2-DR24       | N/A                | 1-PS240 (triple)               | 4-CROSS30       | 4-BAR30                    | 4-TEE36 + 3*  |
|                              | -B26448/30 | 260 X 47.25         | 3 PC  | 20               | 2-XB20 & 2-XB26    | 2-CU16 & 2-CU24   | 2-DR18 & 2-DR24       | N/A                | 1-PS264 (triple)               | 5-CROSS30       | 5-BAR30                    | 4-TEE36 + 3*  |
|                              | -B28848/30 | 283.5 X 47.25       | 3 PC  | 22               | 2-XB20 & 2-XB26    | 2-CU16 & 2-CU24   | 2-DR18 & 2-DR24       | N/A                | 1-PS288 (triple)               | 5-CROSS30       | 5-BAR30                    | 4-TEE36 + 3*  |
| <br>SQUARE                   | -SQ36      | 35.5 X 35.5         | 1 PC. | 4                | 1-XB26             | 1-CU20            | 1-DR18                | N/A                | N/A                            | 1-CROSS30       | 1-BAR30                    | 2-TEE36       |
|                              | -SQ42      | 41.5 X 41.5         | 1 PC. | 4                | 1-XB26             | 1-CU20            | 1-DR24                | N/A                | N/A                            | 1-CROSS30       | 1-BAR30                    | 2-TEE36       |
|                              | -SQ48      | 47.25 X 47.25       | 1 PC. | 4                | 1-XB33             | 1-CU24            | 1-DR24                | N/A                | N/A                            | 1-CROSS30       | 1-BAR30                    | 2-TEE36       |
|                              | -SQ54      | 53.25 X 53.25       | 1 PC. | 4                | 1-XB36             | 1-CU24            | 1-DR30                | N/A                | N/A                            | 1-CROSS36       | 1-BAR36                    | 2-TEE36       |
|                              | -SQ60      | 59 X 59             | 1 PC. | 8                | 1-XB42             | 1-CU30            | 1-DR30                | N/A                | N/A                            | 1-CROSS36       | 1-BAR36                    | 2-TEE36       |

\* QUANTITY OF CENTER SUPPORTS REQUIRED. CONTACT CUSTOMER SERVICE FOR INFO  
 \*\* REQUIRES SQUARE END OF TEARDROP TO BE BRACKETED TO ADJOINING UNIT OTHERWISE, 2 LEGS REQUIRED.

◆ ONE (1) STIFFENER BAR IS RECOMMENDED. SEE PAGE 900-15.  
 ◆◆ TWO (2) STIFFENER BARS ARE RECOMMENDED. SEE PAGE 900-15.  
 ◆◆◆◆ FOUR (4) STIFFENER BARS ARE RECOMMENDED. SEE PAGE 900-15.

## Accessories

♥ The 100 Series now has expanded options for power and data management.

Flip Top Power Grommets with Data: **100-FTP-DATA**

Flip Top Power Grommets with USB: **100-FTP-USB**

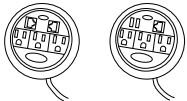

Customizable Power Grommets

**100-RECP-01**

**100-RECP-02**

**100-RECP-03**

**100-RECP-04**

**100-RECP-CUSTOM**

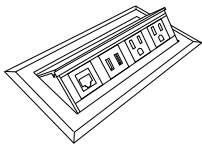

### ADAPTER OPTIONS:

- POWER RECEPTACLES
- 2 USB CHARGING ONLY PORTS @ 2.1AMPS
- ETHERNET (RJ45) PORT
- PHONE (RJ11) PORT
- HDMI PORT
- VGA PORT
- OPTION TO INCLUDE A SURGE PROTECTOR

### FINISH OPTIONS:

- ANODIZED ALUMINUM
- BLACK
- WHITE
- BRONZE

Angled Power Grommets

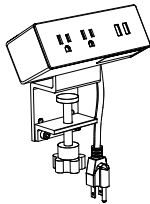

Power Bar with USB

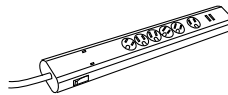

Round Power Grommet with USB

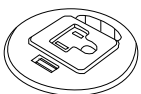

See 100 Series page **100-6**. for complete details details

**USE THIS CHART TO DETERMINE CORRECT LAMINATE TABLE TOP & BASE COMBINATIONS.**

NOTE: WHEN ORDERING 900 SERIES, SPECIFY EDGE DETAIL (FLUTED OR NON FLUTED)

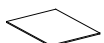
| TOP TYPE- REF<br>PGS 900-(9-10)   | MODEL#     | SPIDER-<br>METAL | TAPER, 2.5" ROUND<br>OR SQUARE LEG | 2" SQUARE<br>LEG -OFFSET<br>(2-PACK) | 4.75"<br>ROUND-<br>METAL | SQUARE/ROUND<br>METAL BASE<br>COFFEE TABLE<br>HEIGHT | SQUARE/ROUND<br>METAL BASE | SQUARE/ROUND<br>METAL BASE<br>BAR HEIGHT | METAL LOOP<br>LEGS        | ELECTRIC<br>HEIGHT<br>ADJUSTABLE |
|---|------------|------------------|------------------------------------|--------------------------------------|--------------------------|--|----------------------------|--|---------------------------|----------------------------------|
|   | -B7236/27  | 4-SPIDERLEG◆     | 4-TAPERLEG/RL2.5/SQ3◆              | 2-SQ2OFFSET                          | 4-RL5◆                   | 2-SQB20CFT/<br>2-ROU20CFT                            | 2-SQB20/<br>2-ROU20        | 2-SQB20BAR/<br>2-ROU20BAR                | 2-LOOP30                  | 1-E1-72                          |
|   | -B8436/27  | 4-SPIDERLEG + 1* | 5-TAPERLEG/RL2.5/SQ3               | 3-SQ2OFFSET                          | 5-RL5                    | 2-SQB20CFT/<br>2-ROU20CFT                            | 2-SQB20/<br>2-ROU20        | 2-SQB20BAR/<br>2-ROU20BAR                | 3-LOOP30                  | 1-E1-84                          |
|   | -B9644/30  | 4-SPIDERLEG + 1* | 5-TAPERLEG/RL2.5/SQ3               | 3-SQ2OFFSET                          | 5-RL5                    | 2-SQB20CFT◆◆/<br>2-ROU20CFT◆◆                        | 2-SQB20◆◆/<br>2-ROU20◆◆    | N/A                                      | N/A                       | 1-E1-96                          |
|   | -B12048/30 | 6-SPIDERLEG◆◆    | 6-TAPERLEG/RL2.5/SQ3◆◆             | 3-SQ2OFFSET                          | 6-RL5◆◆                  | 3-SQB20CFT/<br>3-ROU20CFT                            | 3-SQB20/<br>3-ROU20        | N/A                                      | N/A                       | N/A                              |
|   | -B14448/30 | 6-SPIDERLEG◆◆◆   | 6-TAPERLEG/RL2.5/SQ3◆◆◆            | 3-SQ2OFFSET                          | 6-RL5◆◆◆                 | 3-SQB20CFT/<br>3-ROU20CFT                            | 3-SQB20/<br>3-ROU20        | N/A                                      | N/A                       | N/A                              |
| <br>BOAT   | -B15648/30 | 6-SPIDERLEG + 2* | 8-TAPERLEG/RL2.5/SQ3               | 4-SQ2OFFSET                          | 8-RL5                    | 3-SQB20CFT◆◆◆/<br>3-ROU20CFT◆◆◆                      | 3-SQB20◆◆◆/<br>3-ROU20◆◆◆  | N/A                                      | N/A                       | N/A                              |
|   | -B16848/30 | 6-SPIDERLEG + 2* | 8-TAPERLEG/RL2.5/SQ3               | 4-SQ2OFFSET                          | 8-RL5                    | 3-SQB20CFT◆◆◆/<br>3-ROU20CFT◆◆◆                      | 3-SQB20◆◆◆/<br>3-ROU20◆◆◆  | N/A                                      | N/A                       | N/A                              |
|   | -B19248/30 | 6-SPIDERLEG + 2* | 8-TAPERLEG/RL2.5/SQ3               | 4-SQ2OFFSET                          | 8-RL5                    | 4-SQB20CFT/<br>4-ROU20CFT                            | 4-SQB20/<br>4-ROU20        | N/A                                      | N/A                       | N/A                              |
|   | -B21648/30 | 8-SPIDERLEG + 3* | 11-TAPERLEG/RL2.5/SQ3              | 6-SQ2OFFSET                          | 11-RL5                   | 6-SQB20CFT/<br>6-ROU20CFT                            | 6-SQB20/<br>6-ROU20        | N/A                                      | N/A                       | N/A                              |
|   | -B24048/30 | 8-SPIDERLEG + 3* | 11-TAPERLEG/RL2.5/SQ3              | 6-SQ2OFFSET                          | 11-RL5                   | 6-SQB20CFT/<br>6-ROU20CFT                            | 6-SQB20/<br>6-ROU20        | N/A                                      | N/A                       | N/A                              |
|   | -B26448/30 | 8-SPIDERLEG + 3* | 11-TAPERLEG/RL2.5/SQ3              | 6-SQ2OFFSET                          | 11-RL5                   | 6-SQB20CFT/<br>6-ROU20CFT                            | 6-SQB20/<br>6-ROU20        | N/A                                      | N/A                       | N/A                              |
|   | -B28848/30 | 8-SPIDERLEG + 3* | 11-TAPERLEG/RL2.5/SQ3              | 6-SQ2OFFSET                          | 11-RL5                   | 6-SQB20CFT/<br>6-ROU20CFT                            | 6-SQB20/<br>6-ROU20        | N/A                                      | N/A                       | N/A                              |
|   |            | -SQ36            | 4-SPIDERLEG                        | 4-TAPERLEG/RL2.5/SQ3                 | 2-SQ2OFFSET              | 4-RL5  | 1-SQB20CFT/<br>1-ROU20CFT  | 1-SQB20/<br>1-ROU20                      | 1-SQB20BAR/<br>1-ROU20BAR | 2-LOOP30                         |
| <br>SQUARE | -SQ42      | 4-SPIDERLEG      | 4-TAPERLEG/RL2.5/SQ3               | 2-SQ2OFFSET                          | 4-RL5                    | 1-SQB20CFT/<br>1-ROU20CFT                            | 1-SQB20/<br>1-ROU20        | 1-SQB20BAR/<br>1-ROU20BAR                | N/A                       | N/A                              |
|   | -SQ48      | 4-SPIDERLEG◆     | 4-TAPERLEG/RL2.5/SQ3◆              | 2-SQ2OFFSET                          | 4-RL5◆                   | N/A  | N/A                        | N/A                                      | N/A                       | N/A                              |
|   | -SQ54      | 4-SPIDERLEG◆◆    | 4-TAPERLEG/RL2.5/SQ3◆◆             | 2-SQ2OFFSET                          | 4-RL5◆◆                  | N/A  | N/A                        | N/A                                      | N/A                       | N/A                              |
|   | -SQ60      | 4-SPIDERLEG◆◆    | 4-TAPERLEG/RL2.5/SQ3◆◆             | 2-SQ2OFFSET                          | 4-RL5◆◆                  | N/A  | N/A                        | N/A                                      | N/A                       | N/A                              |

\* QUANTITY OF CENTER SUPPORTS REQUIRED. CONTACT CUSTOMER SERVICE FOR INFO

\*\* REQUIRES SQUARE END OF TEARDROP TO BE BRACKETED TO ADJOINING UNIT OTHERWISE, 2 LEGS REQUIRED.

◆ ONE (1) STIFFENER BAR IS RECOMMENDED. SEE PAGE 900-15.

◆◆ TWO (2) STIFFENER BARS ARE RECOMMENDED. SEE PAGE 900-15.

◆◆◆ FOUR (4) STIFFENER BARS ARE RECOMMENDED. SEE PAGE 900-15.

♥ Factory installed 2" x 3" Grommet (\$46 each list) available for 900 series tops. Location of grommet/s must be specified with order. Refer page 100-5 for grommet options.

♥ MA1 Monitor arms are available in Black (BL) and Silver (SL) finish and can be both grommet mounted or clamp mounted and are compatible with 900 Series Tops see 100-9.

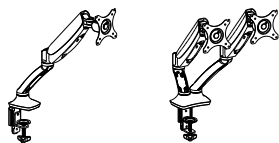

Single mount :100-MA1  
Dual mount: 100-MA2

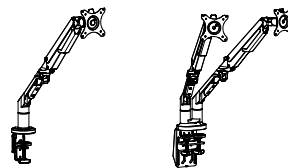

Single mount : 100-MA1B  
Dual mount: 100-MA2B

♥ Wire management tower - safety contain system wires within 12" square wire access tower, complete with quick-click access door. Available in all standard Heartwood finishes and custom sizing is available see 100-11

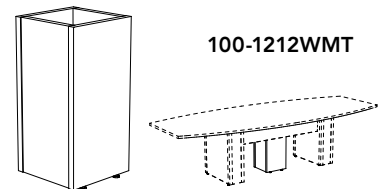

100-1212WMT

TO DETERMINE CORRECT LAMINATE TABLE TOP (910/920) & BASE (900) COMBINATIONS,  
 REFER TO PAGE 900-4 - 900-7 '900 SERIES TABLE BASE CHART'

| MODEL | LIST | WEIGHT | H  |
|-------|------|--------|----|
|       |      | LBS    | IN |

**CROSS BASE**

1 PER CARTON. INCLUDES LEVELERS. EASILY CONVERTS TO MOBILE W/ OPTIONAL CASTERS (900-50CASTER).

|                    |              |           |           |
|--------------------|--------------|-----------|-----------|
| <b>900-CROSS24</b> | <b>\$247</b> | <b>16</b> | <b>28</b> |
|--------------------|--------------|-----------|-----------|

|                    |              |           |           |
|--------------------|--------------|-----------|-----------|
| <b>900-CROSS30</b> | <b>\$263</b> | <b>18</b> | <b>28</b> |
|--------------------|--------------|-----------|-----------|

AVAILABLE FINISHES: BLACK (BL) & SILVER (SL)

|                    |              |           |           |
|--------------------|--------------|-----------|-----------|
| <b>900-CROSS36</b> | <b>\$281</b> | <b>19</b> | <b>28</b> |
|--------------------|--------------|-----------|-----------|

AVAILABLE FINISH: BLACK (BL)

**BAR HEIGHT CROSS BASE**

2 CARTONS (RECYCLE 28" POST - REPLACE W/ 41" POST). INCLUDES LEVELERS. EASILY CONVERTS TO MOBILE W/ OPTIONAL CASTERS (900-50CASTER).

|                  |              |           |           |
|------------------|--------------|-----------|-----------|
| <b>900-BAR24</b> | <b>\$312</b> | <b>29</b> | <b>41</b> |
|------------------|--------------|-----------|-----------|

|                  |              |           |           |
|------------------|--------------|-----------|-----------|
| <b>900-BAR30</b> | <b>\$326</b> | <b>31</b> | <b>41</b> |
|------------------|--------------|-----------|-----------|

AVAILABLE FINISHES: BLACK (BL) & SILVER (SL)

|                  |              |           |           |
|------------------|--------------|-----------|-----------|
| <b>900-BAR36</b> | <b>\$348</b> | <b>34</b> | <b>41</b> |
|------------------|--------------|-----------|-----------|

AVAILABLE FINISH: BLACK (BL)

**TEE BASE**

1 PER CARTON. INCLUDES LEVELERS. EASILY CONVERTS TO MOBILE W/ OPTIONAL CASTERS (900-50CASTER).

|                  |              |           |           |
|------------------|--------------|-----------|-----------|
| <b>900-TEE24</b> | <b>\$158</b> | <b>13</b> | <b>28</b> |
|------------------|--------------|-----------|-----------|

|                  |              |           |           |
|------------------|--------------|-----------|-----------|
| <b>900-TEE30</b> | <b>\$164</b> | <b>14</b> | <b>28</b> |
|------------------|--------------|-----------|-----------|

AVAILABLE FINISHES: BLACK (BL), SILVER (SL) & WHITE (WH)

|                  |              |           |           |
|------------------|--------------|-----------|-----------|
| <b>900-TEE36</b> | <b>\$183</b> | <b>14</b> | <b>28</b> |
|------------------|--------------|-----------|-----------|

AVAILABLE FINISH: BLACK (BL)

**COFFEE TABLE HEIGHT SQUARE METAL BASE**

|                     |              |             |              |
|---------------------|--------------|-------------|--------------|
| <b>900-SQB20CFT</b> | <b>\$474</b> | <b>35.5</b> | <b>15.75</b> |
|---------------------|--------------|-------------|--------------|

• INCLUDES LEVELERS. SHIPS IN 2 CARTONS.

AVAILABLE FINISHES: BLACK (BL) & SILVER (SL)

**SQUARE METAL BASE**

|                  |              |             |           |
|------------------|--------------|-------------|-----------|
| <b>900-SQB20</b> | <b>\$474</b> | <b>36.5</b> | <b>28</b> |
|------------------|--------------|-------------|-----------|

• INCLUDES LEVELERS. SHIPS IN 2 CARTONS.

AVAILABLE FINISHES: BLACK (BL), WHITE (WH) & SILVER (SL)

**BAR HEIGHT SQUARE METAL BASE**

|                     |              |             |           |
|---------------------|--------------|-------------|-----------|
| <b>900-SQB20BAR</b> | <b>\$538</b> | <b>40.3</b> | <b>41</b> |
|---------------------|--------------|-------------|-----------|

• INCLUDES LEVELERS. SHIPS IN 2 CARTONS.



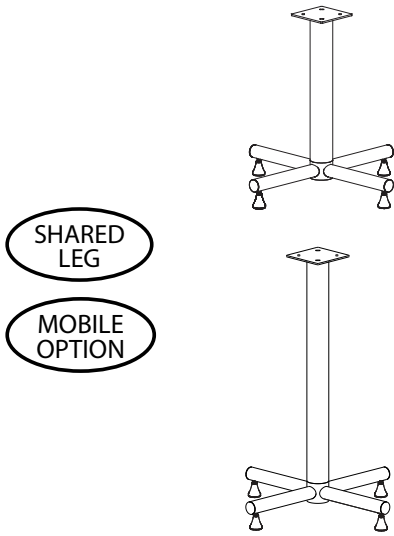

AVAILABLE FINISHES: BLACK (BL), WHITE (WH) & SILVER (SL)

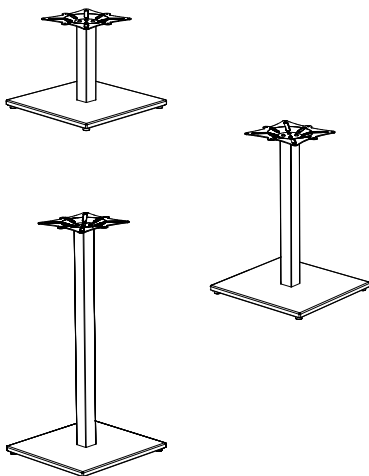
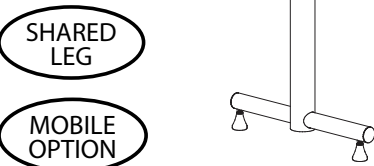

**NOTE:** CONTACT CUSTOMER SERVICE FOR CUSTOM HEIGHT BASE PRICING.

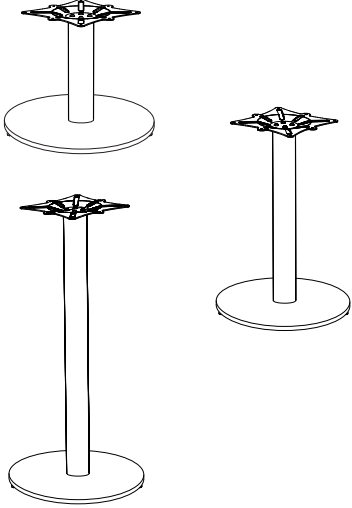
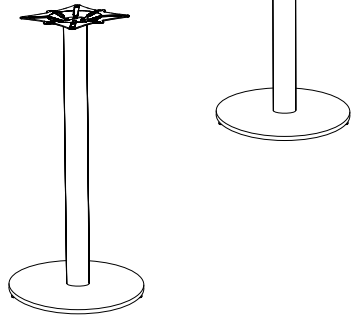
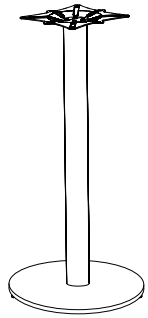
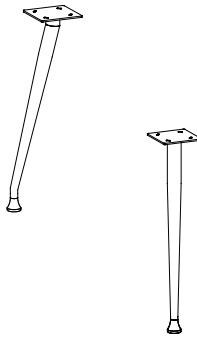

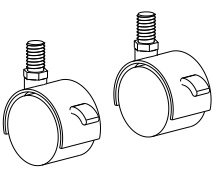
TO DETERMINE CORRECT LAMINATE TABLE TOP (910/920) & BASE (900) COMBINATIONS,  
REFER TO PAGE 900-4 - 900-7 '900 SERIES TABLE BASE CHART'

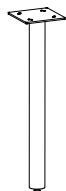
|   | MODEL  | LIST         | WEIGHT<br>LBS | H<br>IN      |
|---|--|--------------|---------------|--------------|
| <b>COFFEE TABLE HEIGHT ROUND METAL BASE</b>   |  |              |               |              |
|    | <b>900-ROU20CFT</b>  | <b>\$474</b> | <b>35.5</b>   | <b>15.75</b> |
|   | <ul style="list-style-type: none"> <li>INCLUDES LEVELERS. SHIPS IN 2 CARTONS.</li> </ul> <b>AVAILABLE FINISHES:</b> BLACK (BL) & SILVER (SL)             |              |               |              |
| <b>ROUND METAL BASE</b>   |  |              |               |              |
|    | <b>900-ROU20</b>   | <b>\$474</b> | <b>36.5</b>   | <b>28</b>    |
|   | <ul style="list-style-type: none"> <li>INCLUDES LEVELERS. SHIPS IN 2 CARTONS.</li> </ul> <b>AVAILABLE FINISHES:</b> BLACK (BL), WHITE (WH) & SILVER (SL) |              |               |              |
| <b>BAR HEIGHT ROUND METAL BASE</b>  |  |              |               |              |
|    | <b>900-ROU20BAR</b>  | <b>\$538</b> | <b>40.3</b>   | <b>41</b>    |
|   | <ul style="list-style-type: none"> <li>INCLUDES LEVELERS. SHIPS IN 2 CARTONS.</li> </ul> <b>AVAILABLE FINISHES:</b> BLACK (BL), WHITE (WH) & SILVER (SL) |              |               |              |
| <b>SPIDER LEG</b>   |  |              |               |              |
|   | 1 PER CARTON. INCLUDES LEVELERS. EASILY CONVERTS TO MOBILE W/ OPTIONAL CASTERS (900-50CASTER).   |              |               |              |
|   | <b>900-SPIDERLEG</b>   | <b>\$103</b> | <b>6.8</b>    | <b>28</b>    |
| <b>STRAIGHT TAPERED LEG</b>   |  |              |               |              |
|  | 1 PER CARTON. INCLUDES LEVELERS. EASILY CONVERTS TO MOBILE W/ OPTIONAL CASTERS (900-50CASTER).   |              |               |              |
|   | <b>900-TAPERLEG</b>  | <b>\$96</b>  | <b>6</b>      | <b>28</b>    |
| <b>OPTIONAL CASTERS</b>   |  |              |               |              |
|  | 2 PER CARTON. 50MM DIAMETER WHEEL. LOCKING BLACK WHEEL. EASILY INTERCHANGEABLE WITH LEVELERS.M8 THREAD   |              |               |              |
|   | <b>900-50CASTER</b>  | <b>\$32</b>  | <b>.4</b>     |              |
| <b>4 3/4" ROUND LEG</b>   |  |              |               |              |
|  | 1 PER CARTON. INCLUDES LEVELER. OPTIONAL CASTER NOT AVAILABLE.   |              |               |              |
|   | <b>900-RL5</b>   | <b>\$163</b> | <b>12.8</b>   | <b>28</b>    |
| <b>2 1/2" ROUND LEG</b>   |  |              |               |              |
|  | 1 PER CARTON. INCLUDES LEVELER. OPTIONAL CASTER NOT AVAILABLE.   |              |               |              |
|   | <b>900-RL2.5</b>   | <b>\$96</b>  | <b>7.2</b>    | <b>28</b>    |

SHARED LEG  
MOBILE OPTION

# 900 BASES

## METAL TABLE BASES & LEGS

TO DETERMINE CORRECT LAMINATE TABLE TOP (910/920) & BASE (900) COMBINATIONS,  
REFER TO PAGE 900-4 - 900-7 '900 SERIES TABLE BASE CHART'

| MODEL | LIST | WEIGHT<br>LBS | H<br>IN |
|-------|------|---------------|---------|
|-------|------|---------------|---------|

### 3" SQUARE LEG

1 PER CARTON. INCLUDES LEVELER. OPTIONAL CASTER NOT AVAILABLE.

|                |              |            |           |
|----------------|--------------|------------|-----------|
| <b>900-SQ3</b> | <b>\$151</b> | <b>9.5</b> | <b>28</b> |
|----------------|--------------|------------|-----------|

AVAILABLE FINISHES: BLACK (BL), SILVER (SL) & WHITE (WH)

SHARED  
LEG

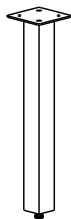

### 2" SQUARE POST LEG WITH OFFSET TOP PLATE

SOLD IN QTY 2

|                      |              |            |           |
|----------------------|--------------|------------|-----------|
| <b>900-SQ2OFFSET</b> | <b>\$194</b> | <b>4.3</b> | <b>28</b> |
|----------------------|--------------|------------|-----------|

AVAILABLE FINISHES: BLACK (BL), SILVER (SL) & WHITE (WH)

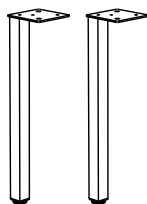

### METAL LOOP LEGS

|                   |              |             |           |
|-------------------|--------------|-------------|-----------|
| <b>900-LOOP24</b> | <b>\$188</b> | <b>16.5</b> | <b>28</b> |
|-------------------|--------------|-------------|-----------|

USE W/ 24" TOP OR WORK SURFACE

|                   |              |             |           |
|-------------------|--------------|-------------|-----------|
| <b>900-LOOP30</b> | <b>\$207</b> | <b>18.7</b> | <b>28</b> |
|-------------------|--------------|-------------|-----------|

USE W/ 30" TOP OR WORK SURFACE

- 1 PER CARTON. INCLUDES LEVELER.
- OPTIONAL CASTER NOT AVAILABLE.

AVAILABLE FINISHES: BLACK (BL), SILVER (SL) & WHITE (WH)

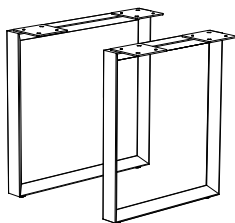

## 900 LAMINATE BASES

### CUBE LAMINATE BASE

24" TO 30" TOP SIZE

|                 |              |           |           |
|-----------------|--------------|-----------|-----------|
| <b>900-CU16</b> | <b>\$538</b> | <b>34</b> | <b>28</b> |
|-----------------|--------------|-----------|-----------|

>30" TO 42" TOP SIZE

|                 |              |           |           |
|-----------------|--------------|-----------|-----------|
| <b>900-CU20</b> | <b>\$604</b> | <b>42</b> | <b>28</b> |
|-----------------|--------------|-----------|-----------|

>42" TO 54" TOP SIZE

|                 |              |           |           |
|-----------------|--------------|-----------|-----------|
| <b>900-CU24</b> | <b>\$679</b> | <b>51</b> | <b>28</b> |
|-----------------|--------------|-----------|-----------|

>54" TO 66" TOP SIZE

|                 |              |           |           |
|-----------------|--------------|-----------|-----------|
| <b>900-CU30</b> | <b>\$952</b> | <b>63</b> | <b>28</b> |
|-----------------|--------------|-----------|-----------|

- INCLUDES LEVELERS
- CONTACT CUSTOMER SERVICE FOR > 66" TO 72" TOP SIZE

#### NOTE:

- FLOOR WIRE MANAGEMENT ACCESS IS STANDARD. FOR AN OPTIONAL POWER MANAGEMENT ACCESS PANEL PLEASE ADD UPCHARGE OF

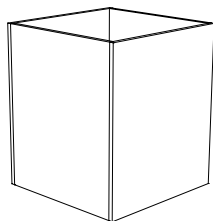



TO DETERMINE CORRECT LAMINATE TABLE TOP (910/920) & BASE (900) COMBINATIONS,  
REFER TO PAGE 900-4 - 900-7 '900 SERIES TABLE BASE CHART'

| MODEL | LIST | WEIGHT<br>LBS | H<br>IN |
|-------|------|---------------|---------|
|-------|------|---------------|---------|

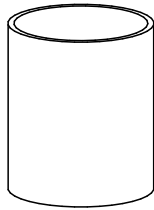

**DRUM BASE**

HIGH PRESSURE LAMINATE CONSTRUCTION DRUM. WIRE ACCESS HOLE DRILLED IN BOTTOM.

|          |         |    |    |
|----------|---------|----|----|
| 900-DR18 | \$724   | 60 | 28 |
| 900-DR24 | \$799   | 62 | 28 |
| 900-DR30 | \$1,072 | 70 | 28 |

RTA

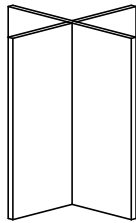

**CROSS BASE - 1" CONSTRUCTION**

|          |       |    |    |
|----------|-------|----|----|
| 900-XB20 | \$359 | 30 | 28 |
| 900-XB26 | \$446 | 30 | 28 |
| 900-XB36 | \$480 | 35 | 28 |

RTA

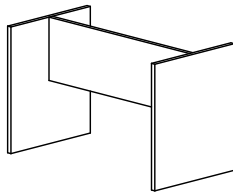

**PANEL BASE SETS - 1" GABLES & MODESTY PANELS**

SINGLE PANEL BASE SET

|          |       |    |    |
|----------|-------|----|----|
| 900-PS60 | \$520 | 50 | 28 |
| 900-PS72 | \$593 | 60 | 28 |
| 900-PS84 | \$601 | 65 | 28 |
| 900-PS96 | \$607 | 70 | 28 |

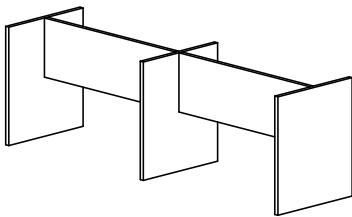

DOUBLE PANEL BASE SET

|           |         |     |    |
|-----------|---------|-----|----|
| 900-PS120 | \$925   | 100 | 28 |
| 900-PS144 | \$934   | 105 | 28 |
| 900-PS156 | \$994   | 111 | 28 |
| 900-PS168 | \$1,038 | 117 | 28 |
| 900-PS192 | \$1,074 | 129 | 28 |

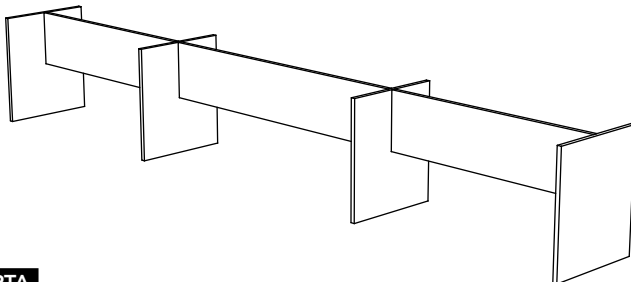

TRIPLE PANEL BASE SET

|           |         |     |    |
|-----------|---------|-----|----|
| 900-PS216 | \$1,382 | 141 | 28 |
| 900-PS240 | \$1,552 | 153 | 28 |
| 900-PS264 | \$1,731 | 165 | 28 |
| 900-PS288 | \$1,926 | 177 | 28 |

RTA

TO DETERMINE CORRECT LAMINATE TABLE TOP (910/920) & BASE (900) COMBINATIONS,  
 REFER TO PAGE 900-4 - 900-7 '900 SERIES TABLE BASE CHART'

| MODEL | LIST | WEIGHT<br>LBS | H<br>IN |
|-------|------|---------------|---------|
|-------|------|---------------|---------|

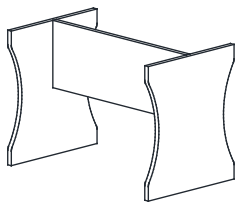

**SCALLOPED PANEL BASE SETS - 1" GABLES & MODESTY PANELS**

SINGLE PANEL BASE SET

|           |       |    |    |
|-----------|-------|----|----|
| 900-SPS60 | \$642 | 50 | 28 |
| 900-SPS72 | \$712 | 60 | 28 |
| 900-SPS84 | \$718 | 65 | 28 |
| 900-SPS96 | \$765 | 70 | 28 |

DOUBLE PANEL BASE SET

|            |         |     |    |
|------------|---------|-----|----|
| 900-SPS120 | \$1,030 | 100 | 28 |
| 900-SPS144 | \$1,037 | 105 | 28 |
| 900-SPS156 | \$1,095 | 109 | 28 |
| 900-SPS168 | \$1,138 | 115 | 28 |
| 900-SPS192 | \$1,170 | 127 | 28 |

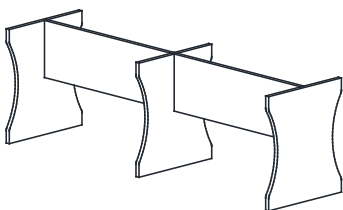

TRIPLE PANEL BASE SET

|            |         |     |    |
|------------|---------|-----|----|
| 900-SPS216 | \$1,534 | 139 | 28 |
| 900-SPS240 | \$1,721 | 151 | 28 |
| 900-SPS264 | \$1,921 | 163 | 28 |
| 900-SPS288 | \$2,137 | 175 | 28 |

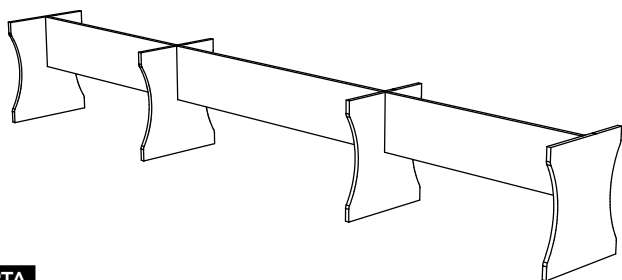

RTA

**TRESTLE PANEL BASE SETS - 1" GABLES & ¾" MODESTY PANELS**

SINGLE TRESTLE PANEL BASE SET

|           |       |    |    |
|-----------|-------|----|----|
| 900-TPS60 | \$679 | 65 | 28 |
| 900-TPS72 | \$771 | 78 | 28 |
| 900-TPS84 | \$784 | 86 | 28 |
| 900-TPS96 | \$846 | 94 | 28 |

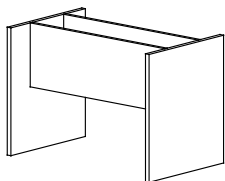

DOUBLE TRESTLE PANEL BASE SET

|            |         |     |    |
|------------|---------|-----|----|
| 900-TPS120 | \$1,204 | 146 | 28 |
| 900-TPS144 | \$1,216 | 155 | 28 |
| 900-TPS156 | \$1,275 | 166 | 28 |
| 900-TPS168 | \$1,322 | 178 | 28 |
| 900-TPS192 | \$1,374 | 190 | 28 |

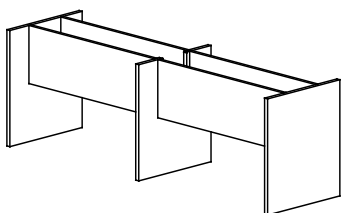

RTA

TO DETERMINE CORRECT LAMINATE TABLE TOP (910/920) & BASE (900) COMBINATIONS,  
REFER TO PAGE 900-4 - 900-7 '900 SERIES TABLE BASE CHART'

| MODEL | LIST | WEIGHT<br>LBS | H<br>IN |
|-------|------|---------------|---------|
|-------|------|---------------|---------|

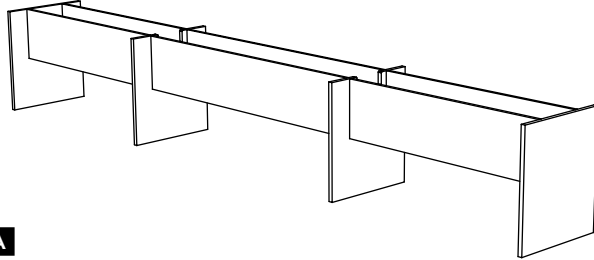

RTA

TRIPLE TRESTLE PANEL BASE SET

|            |         |     |    |
|------------|---------|-----|----|
| 900-TPS216 | \$1,658 | 202 | 28 |
| 900-TPS240 | \$1,861 | 214 | 28 |
| 900-TPS264 | \$2,078 | 226 | 28 |
| 900-TPS288 | \$2,311 | 238 | 28 |

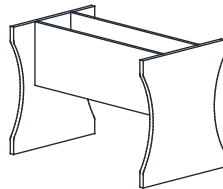

SCALLOPED TRESTLE PANEL BASE SETS - 1" GABLES & 3/4" MODES-TY PANELS

SINGLE PANEL TRESTLE BASE SET

|            |       |    |    |
|------------|-------|----|----|
| 900-STPS60 | \$832 | 65 | 28 |
| 900-STPS72 | \$921 | 78 | 28 |
| 900-STPS84 | \$937 | 86 | 28 |
| 900-STPS96 | \$991 | 94 | 28 |

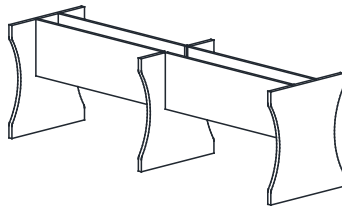

DOUBLE PANEL TRESTLE BASE SET

|             |         |     |    |
|-------------|---------|-----|----|
| 900-STPS120 | \$1,356 | 146 | 28 |
| 900-STPS144 | \$1,367 | 155 | 28 |
| 900-STPS156 | \$1,427 | 164 | 28 |
| 900-STPS168 | \$1,473 | 176 | 28 |
| 900-STPS192 | \$1,526 | 188 | 28 |

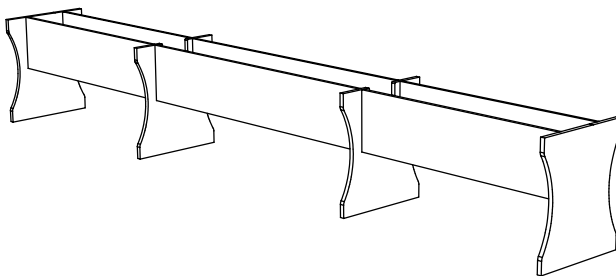

TRIPLE PANEL TRESTLE BASE SET

|             |         |     |    |
|-------------|---------|-----|----|
| 900-STPS216 | \$1,840 | 200 | 28 |
| 900-STPS240 | \$2,067 | 212 | 28 |
| 900-STPS264 | \$2,306 | 224 | 28 |
| 900-STPS288 | \$2,566 | 236 | 28 |

RTA

# 900 BASES

## METAL LEG TRESTLE PANEL BASE SETS & TRESTLE CUBE BASE SETS & METAL EDGE TRESTLE CUBE BASE SETS & TRESTLE CUBE BASE SETS



TO DETERMINE CORRECT LAMINATE TABLE TOP (910/920) & BASE (900) COMBINATIONS,  
REFER TO PAGE 900-4 - 900-7 '900 SERIES TABLE BASE CHART'

| MODEL | LIST | WEIGHT<br>LBS | H<br>IN |
|-------|------|---------------|---------|
|-------|------|---------------|---------|

### TRESTLE CUBE BASE SET - 3/4" MODESTIES

#### CUBE BASE SET - 2 CUBES

|            |         |     |    |
|------------|---------|-----|----|
| 900-TPC60  | \$1,171 | 75  | 28 |
| 900-TPC72  | \$1,216 | 79  | 28 |
| 900-TPC84  | \$1,262 | 83  | 28 |
| 900-TPC96  | \$1,323 | 88  | 28 |
| 900-TPC120 | \$1,410 | 97  | 28 |
| 900-TPC144 | \$1,611 | 106 | 28 |

#### CUBE BASE SET - 3 CUBES

|            |         |     |    |
|------------|---------|-----|----|
| 900-TPC156 | \$1,977 | 141 | 28 |
| 900-TPC168 | \$2,050 | 146 | 28 |
| 900-TPC192 | \$2,132 | 156 | 28 |

#### CUBE BASE SET - 3 CUBES

|            |         |     |    |
|------------|---------|-----|----|
| 900-TPC216 | \$3,058 | 166 | 28 |
| 900-TPC240 | \$3,303 | 176 | 28 |
| 900-TPC264 | \$3,684 | 186 | 28 |
| 900-TPC288 | \$4,052 | 196 | 28 |

- FLOOR WIRE MANAGEMENT ACCESS IS STANDARD.
- FOR AN OPTIONAL POWER MANAGEMENT ACCESS PANEL PLEASE ADD UPCHARGE OF \$436 LIST PER BASE TO ABOVE PRICES AND ADD A -D TO THE END OF SKU.
- THE WIDTH OF THE CUBE ON A TRIPLE CUBE BASE SET CHANGES FROM 8" TO 16"

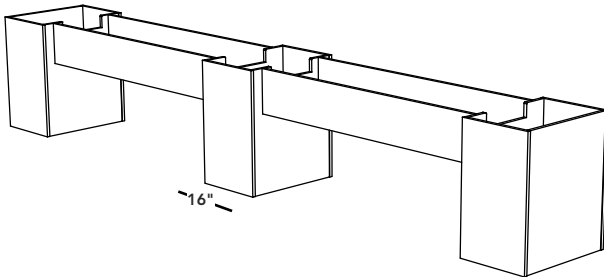
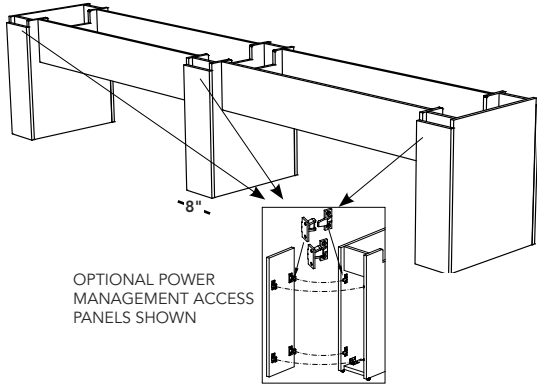
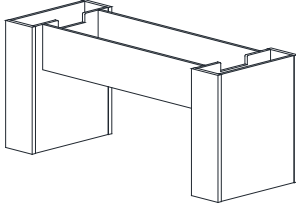

### METAL EDGE TRESTLE CUBE BASE - 3/4" MODESTIES

#### CUBE BASE SET - 2 CUBES

|             |         |     |    |
|-------------|---------|-----|----|
| 900-MTPC60  | \$1,513 | 75  | 28 |
| 900-MTPC72  | \$1,552 | 79  | 28 |
| 900-MTPC84  | \$1,598 | 83  | 28 |
| 900-MTPC96  | \$1,631 | 88  | 28 |
| 900-MTPC120 | \$1,741 | 97  | 28 |
| 900-MTPC144 | \$1,910 | 106 | 28 |

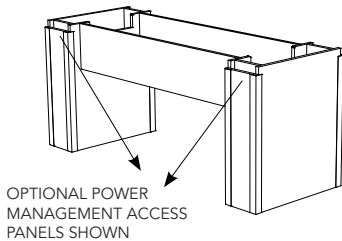

TO DETERMINE CORRECT LAMINATE TABLE TOP (910/920) & BASE (900) COMBINATIONS,  
REFER TO PAGE 900-4 - 900-7 '900 SERIES TABLE BASE CHART'

| MODEL | LIST | WEIGHT<br>LBS | H<br>IN |
|-------|------|---------------|---------|
|-------|------|---------------|---------|

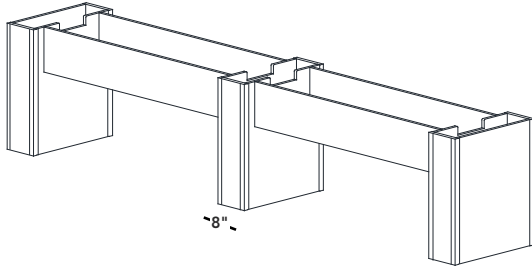

**METAL EDGE TRESTLE CUBE BASE - 3/4" MODESTIES**

CUBE BASE SET - 3 CUBES

|             |                |     |    |
|-------------|----------------|-----|----|
| 900-MTPC156 | <b>\$2,398</b> | 141 | 28 |
| 900-MTPC168 | <b>\$2,466</b> | 146 | 28 |
| 900-MTPC192 | <b>\$2,605</b> | 156 | 28 |

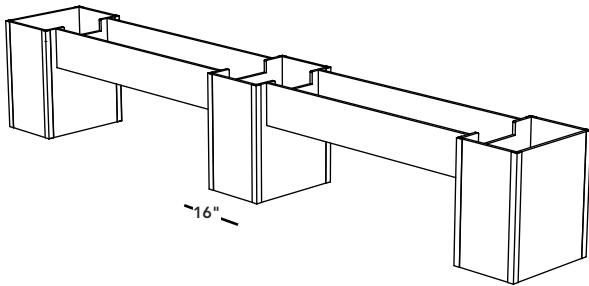

CUBE BASE SET - 3 CUBES

|             |                |     |    |
|-------------|----------------|-----|----|
| 900-MTPC216 | <b>\$3,371</b> | 166 | 28 |
| 900-MTPC240 | <b>\$3,684</b> | 176 | 28 |
| 900-MTPC264 | <b>\$4,184</b> | 186 | 28 |
| 900-MTPC288 | <b>\$4,684</b> | 196 | 28 |

**NOTES:**

- FLOOR WIRE MANAGEMENT ACCESS IS STANDARD. FOR AN OPTIONAL POWER MANAGEMENT ACCESS PANEL PLEASE ADD UPCHARGE OF **\$436** LIST PER BASE TO ABOVE PRICES AND ADD A **-D** TO THE END OF SKU.
- THE WIDTH OF THE CUBE ON A TRIPLE CUBE BASE SET CHANGES FROM 8" TO 16"
- METAL EDGE HIGHLIGHT IS SILVER (SL)

**RTA**

**WORK SURFACE STIFFENER BARS**

| MODEL | LIST | DESCRIPTION | WEIGHT<br>LBS | CUBE<br>FT <sup>3</sup> |
|-------|------|-------------|---------------|-------------------------|
|-------|------|-------------|---------------|-------------------------|

**STIFFENER BARS**

|            |             |                                       |     |     |
|------------|-------------|---------------------------------------|-----|-----|
| 100-WSB-40 | <b>\$82</b> | 40" STIFFENER BAR FOR USE W/ 48" TOPS | 5.5 | 0.2 |
| 100-WSB-46 | <b>\$82</b> | 46" STIFFENER BAR FOR USE W/ 54" TOPS | 6.4 | 0.2 |
| 100-WSB-52 | <b>\$82</b> | 52" STIFFENER BAR FOR USE W/ 60" TOPS | 7.1 | 0.2 |
| 100-WSB-58 | <b>\$82</b> | 58" STIFFENER BAR FOR USE W/ 66" TOPS | 8.2 | 0.2 |
| 100-WSB-64 | <b>\$82</b> | 64" STIFFENER BAR FOR USE W/ 72" TOPS | 9   | 0.2 |
| 100-WSB-70 | <b>\$82</b> | 70" STIFFENER BAR FOR USE W/ 78" TOPS | 9.9 | 0.3 |



- STIFFENER BARS REQUIRED WHEN USING TEE, SPIDER, TAPER, RL5, RL2.5 AND SQ3 LEGS.
- UNSUPPORTED WORKSURFACE SPANS GREATER THAN 48" REQUIRE A STIFFENER BAR.

HIGH PRESSURE LAMINATE AVAILABLE- CONTACT CUSTOMER SERVICE FOR DETAILS.  
**FOR TABLE BASE COMPATIBILITY- REFER TO PAGE 900-7 '900 SERIES TABLE BASE CHART'**  
 NOTE: WHEN ORDERING 920 SERIES, SPECIFY EDGE DETAIL (FLUTED OR NON FLUTED)

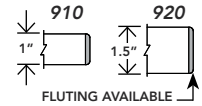

| MODEL | LIST 910 | LIST 920 | DETAILS | SEATING CAPACITY | 910 WEIGHT LBS | 920 WEIGHT LBS |
|-------|----------|----------|---------|------------------|----------------|----------------|
|-------|----------|----------|---------|------------------|----------------|----------------|

**ROUND TOPS**

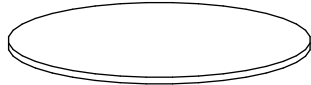

|         |       |         |                |   |    |     |
|---------|-------|---------|----------------|---|----|-----|
| 910-R30 | \$377 | \$525   | 29½" ROUND TOP | 4 | 35 | 53  |
| 910-R36 | \$402 | \$563   | 35½" ROUND TOP | 4 | 40 | 59  |
| 910-R42 | \$484 | \$678   | 41½" ROUND TOP | 5 | 50 | 76  |
| 910-R48 | \$658 | \$921   | 47¼" ROUND TOP | 5 | 60 | 92  |
| 910-R54 | \$744 | \$1,041 | 53¼" ROUND TOP | 6 | 75 | 116 |
| 910-R60 | \$813 | \$1,094 | 59" ROUND TOP  | 7 | 90 | 135 |

- OPTIONAL ADD ON POWER GROMMET OR STANDARD 2 X 3" GROMMET AVAILABLE. SEE [100-6](#) FOR DETAILS. LOCATION MUST BE SPECIFIED W/ ORDER.

**TEARDROP TOP**

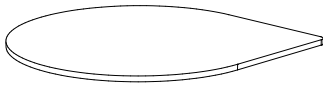

|   |       |       |                   |   |    |     |
|---|-------|-------|-------------------|---|----|-----|
| 910-TD36  | \$463 | \$491 | 35½" TEARDROP TOP | 4 | 42 | 63  |
| CAN BE FREESTANDING OR CONNECTS TO 18" WORKSURFACE. |       |       |                   |   |    |     |
| 910-TD48  | \$675 | \$716 | 47¼" TEARDROP TOP | 5 | 62 | 93  |
| CAN BE FREESTANDING OR CONNECTS TO 24" WORKSURFACE. |       |       |                   |   |    |     |
| 910-TD60  | \$869 | \$921 | 59" ROUND TOP     | 7 | 92 | 138 |

CAN BE FREESTANDING OR CONNECTS TO 30" WORKSURFACE.

- OPTIONAL ADD ON POWER GROMMET OR STANDARD 2 X 3" GROMMET AVAILABLE. SEE [100-6](#) FOR DETAILS. LOCATION MUST BE SPECIFIED W/ ORDER.

**SQUARE TOP**

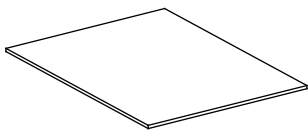

|          |       |       |                 |   |    |     |
|----------|-------|-------|-----------------|---|----|-----|
| 910-SQ36 | \$377 | \$551 | 35½" SQUARE TOP | 4 | 45 | 69  |
| 910-SQ42 | \$402 | \$563 | 45½" SQUARE TOP | 4 | 55 | 83  |
| 910-SQ48 | \$621 | \$815 | 47¼" SQUARE TOP | 4 | 65 | 99  |
| 910-SQ54 | \$658 | \$921 | 53¼" SQUARE TOP | 4 | 80 | 122 |

- OPTIONAL ADD ON POWER GROMMET OR STANDARD 2 X 3" GROMMET AVAILABLE. SEE [100-6](#) FOR DETAILS. LOCATION MUST BE SPECIFIED W/ ORDER.

**RACETRACK TOPS**

1 PIECE TOPS

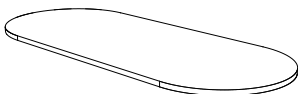

|            |         |         |                       |   |     |     |
|------------|---------|---------|-----------------------|---|-----|-----|
| 910-RT6030 | \$593   | \$886   | 59" LONG X 29½" WIDE  | 6 | 65  | 99  |
| 910-RT7230 | \$623   | \$919   | 71" LONG X 29½" WIDE  | 6 | 75  | 116 |
| 910-RT7236 | \$671   | \$940   | 71" LONG X 35½" WIDE  | 6 | 90  | 135 |
| 910-RT8436 | \$921   | \$1,225 | 82¾" LONG X 35½" WIDE | 8 | 60  | 168 |
| 910-RT9644 | \$1,090 | \$1,421 | 94½" LONG X 43½" WIDE | 8 | 130 | 198 |

HIGH PRESSURE LAMINATE AVAILABLE- CONTACT CUSTOMER SERVICE FOR DETAILS.  
FOR TABLE BASE COMPATIBILITY- REFER TO PAGE 900-7 '900 SERIES TABLE BASE CHART'  
NOTE: WHEN ORDERING 920 SERIES, SPECIFY EDGE DETAIL (FLUTED OR NON FLUTED)

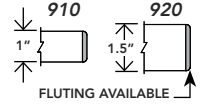

|   | MODEL       | LIST 910 | LIST 920 | DETAILS                          | SEATING CAPACITY | 910 WEIGHT LBS | 920 WEIGHT LBS |
|---|-------------|----------|----------|----------------------------------|------------------|----------------|----------------|
| 2 PIECE TOPS  |             |          |          |                                  |                  |                |                |
|   | 910-RT12048 | \$1,291  | \$1,748  | 118" LONG X 47¼" WIDE (2 PIECE)  | 10               | 175            | 267            |
|   | 910-RT14448 | \$1,423  | \$1,929  | 141¾" LONG X 47¼" WIDE (2 PIECE) | 12               | 220            | 333            |
|   | 910-RT15648 | \$1,933  | \$2,512  | 153½" LONG X 47¼" WIDE (2 PIECE) | 12               | 235            | 353            |
|   | 910-RT16848 | \$2,124  | \$2,761  | 165½" LONG X 47¼" WIDE (2 PIECE) | 12               | 250            | 376            |
|   | 910-RT19248 | \$2,462  | \$3,199  | 189" LONG X 47¼" WIDE (2 PIECE)  | 14               | 280            | 419            |
| 3 PIECE TOPS  |             |          |          |                                  |                  |                |                |
|   | 910-RT21648 | \$3,829  | \$5,007  | 212¾" LONG X 47¼" WIDE (3 PIECE) | 16               | 310            | 462            |
|   | 910-RT24048 | \$4,352  | \$5,319  | 236¼" LONG X 47¼" WIDE (3 PIECE) | 18               | 340            | 505            |
|   | 910-RT26448 | \$5,014  | \$5,819  | 260" LONG X 47¼" WIDE (3 PIECE)  | 20               | 370            | 548            |
|   | 910-RT28848 | \$5,264  | \$6,052  | 283½" LONG X 47¼" WIDE (3 PIECE) | 22               | 400            | 591            |
| <ul style="list-style-type: none"> <li>OPTIONAL ADD ON POWER GROMMET OR STANDARD 2 X 3" GROMMET AVAILABLE. SEE 100-6 FOR DETAILS. LOCATION MUST BE SPECIFIED W/ ORDER.</li> </ul> |             |          |          |                                  |                  |                |                |

**RECTANGLE TOPS**

|   |              |         |         |                                  |    |     |     |
|---|--------------|---------|---------|----------------------------------|----|-----|-----|
| 1 PIECE TOPS  |              |         |         |                                  |    |     |     |
|   | 910-REC6030  | \$593   | \$886   | 59" LONG X 29½" WIDE             | 6  | 67  | 102 |
|   | 910-REC7230  | \$623   | \$919   | 71" LONG X 29½" WIDE             | 6  | 80  | 122 |
|   | 910-REC7236  | \$640   | \$940   | 71" LONG X 35½" WIDE             | 6  | 95  | 145 |
|   | 910-REC8436  | \$880   | \$1,225 | 82¾" LONG X 35½" WIDE            | 8  | 115 | 175 |
|   | 910-REC9644  | \$1,013 | \$1,421 | 94½" LONG X 43½" WIDE            | 8  | 135 | 205 |
| 2 PIECE TOPS  |              |         |         |                                  |    |     |     |
|   | 910-REC12048 | \$1,233 | \$1,748 | 118" LONG X 47¼" WIDE (2 PIECE)  | 10 | 180 | 274 |
|   | 910-REC14448 | \$1,358 | \$1,929 | 141¾" LONG X 47¼" WIDE (2 PIECE) | 12 | 225 | 343 |
|   | 910-REC15648 | \$1,843 | \$2,512 | 153½" LONG X 47¼" WIDE (2 PIECE) | 12 | 235 | 353 |
|   | 910-REC16848 | \$2,028 | \$2,761 | 165½" LONG X 47¼" WIDE (2 PIECE) | 12 | 250 | 376 |
|   | 910-REC19248 | \$2,349 | \$3,199 | 189" LONG X 47¼" WIDE (2 PIECE)  | 14 | 280 | 419 |
| 3 PIECE TOPS  |              |         |         |                                  |    |     |     |
|   | 910-REC21648 | \$3,069 | \$4,691 | 212¾" LONG X 47¼" WIDE (3 PIECE) | 16 | 310 | 462 |
|   | 910-REC24048 | \$4,058 | \$5,047 | 236¼" LONG X 47¼" WIDE (3 PIECE) | 18 | 340 | 505 |
|   | 910-REC26448 | \$4,553 | \$5,487 | 260" LONG X 47¼" WIDE (3 PIECE)  | 20 | 370 | 548 |
|   | 910-REC28848 | \$4,808 | \$5,707 | 283½" LONG X 47¼" WIDE (3 PIECE) | 22 | 400 | 591 |
| <ul style="list-style-type: none"> <li>OPTIONAL ADD ON POWER GROMMET OR STANDARD 2 X 3" GROMMET AVAILABLE. SEE 100-6 FOR DETAILS. LOCATION MUST BE SPECIFIED W/ ORDER.</li> </ul> |              |         |         |                                  |    |     |     |

HIGH PRESSURE LAMINATE AVAILABLE- CONTACT CUSTOMER SERVICE FOR DETAILS.  
FOR TABLE BASE COMPATIBILITY- REFER TO PAGE 900-7 '900 SERIES TABLE BASE CHART'  
NOTE: WHEN ORDERING 920 SERIES, SPECIFY EDGE DETAIL (FLUTED OR NON FLUTED)

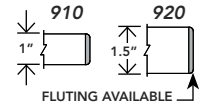

| MODEL | LIST 910 | LIST 920 | DETAILS | SEATING CAPACITY | 910 WEIGHT LBS | 920 WEIGHT LBS |
|-------|----------|----------|---------|------------------|----------------|----------------|
|-------|----------|----------|---------|------------------|----------------|----------------|

**BOAT SHAPE TOPS**

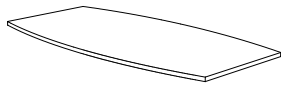

|              |         |         |                                    |   |     |     |
|--------------|---------|---------|------------------------------------|---|-----|-----|
| 910-B7236/27 | \$671   | \$940   | 71" LONG X 35½" WIDE, W/ 26½" END  | 6 | 90  | 135 |
| 910-B8436/27 | \$921   | \$1,225 | 82¾" LONG X 35½" WIDE, W/ 26½" END | 8 | 110 | 168 |
| 910-B9644/30 | \$1,090 | \$1,421 | 94½" LONG X 43½" WIDE, W/ 29½" END | 8 | 130 | 198 |

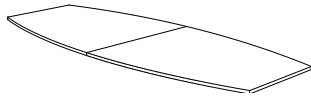

|               |         |         |  |    |     |     |
|---------------|---------|---------|--|----|-----|-----|
| 910-B12048/30 | \$1,291 | \$1,748 | 118" LONG X 47¼" WIDE, W/29½" END (2 PIECE)  | 10 | 175 | 267 |
| 910-B14448/30 | \$1,423 | \$1,929 | 141¾" LONG X 47¼" WIDE, W/29½" END (2 PIECE) | 12 | 220 | 333 |
| 910-B15648/30 | \$1,933 | \$2,512 | 153½" LONG X 47¼" WIDE, W/29½" END (2 PIECE) | 12 | 235 | 353 |
| 910-B16848/30 | \$2,124 | \$2,761 | 165½" LONG X 47¼" WIDE, W/29½" END (2 PIECE) | 12 | 250 | 376 |
| 910-B19248/30 | \$2,462 | \$3,199 | 189" LONG X 47¼" WIDE, W/29½" END (2 PIECE)  | 14 | 280 | 419 |

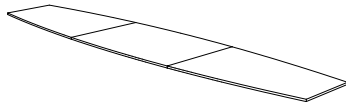

|               |         |         |  |    |     |     |
|---------------|---------|---------|--|----|-----|-----|
| 910-B21648/30 | \$3,829 | \$5,007 | 212¾" LONG X 47¼" WIDE, W/29½" END (3 PIECE) | 16 | 310 | 462 |
| 910-B24048/30 | \$4,352 | \$5,319 | 236¼" LONG X 47¼" WIDE, W/29½" END (3 PIECE) | 18 | 340 | 505 |
| 910-B26448/30 | \$5,014 | \$5,802 | 260" LONG X 47¼" WIDE, W/29½" END (3 PIECE)  | 20 | 370 | 548 |
| 910-B28848/30 | \$5,264 | \$6,052 | 283½" LONG X 47¼" WIDE, W/29½" END (3 PIECE) | 22 | 400 | 591 |

- OPTIONAL ADD ON POWER GROMMET OR STANDARD 2 X 3" GROMMET AVAILABLE. SEE 100-6 FOR DETAILS. LOCATION MUST BE SPECIFIED W/ ORDER.



HIGH PRESSURE LAMINATE AVAILABLE- CONTACT CUSTOMER SERVICE FOR DETAILS.  
NOTE: WHEN ORDERING 920 SERIES, SPECIFY EDGE DETAIL (FLUTED OR NON FLUTED)

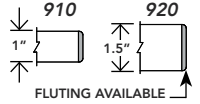

|  | MODEL           | LIST 910 | LIST 920 | DETAILS                          | SEATING CAPACITY | 910 WEIGHT LBS | 920 WEIGHT LBS |
|--|-----------------|----------|----------|----------------------------------|------------------|----------------|----------------|
| <b>ROUND TOP WITH UPSCALE METAL BASE</b>         |                 |          |          |                                  |                  |                |                |
| 1 PIECE TOPS                                     |                 |          |          |                                  |                  |                |                |
| <p><b>FRAME ONLY AVAILABLE IN BLACK</b></p>      | 910-R36-MUP     | \$1,912  | \$2,073  | 35½" LONG X 35½" WIDE            | 4                | 54             | 73             |
|  | 910-R42-MUP     | \$2,079  | \$2,273  | 41½" LONG X 41½" WIDE            | 5                | 64             | 90             |
|  | 910-R48-MUP     | \$2,293  | \$2,556  | 47¼" LONG X 47¼" WIDE            | 5                | 75             | 107            |
|  | 910-R54-MUP     | \$2,454  | \$2,751  | 53¼" LONG X 53¼" WIDE            | 6                | 91             | 132            |
|  | 910-R60-MUP     | \$2,563  | \$2,844  | 59¼" LONG X 59¼" WIDE            | 7                | 107            | 152            |
| AVAILABLE LEG FINSHES: BLACK (BL) OR CHROME (CR) |                 |          |          |                                  |                  |                |                |
| <b>SQUARE TOP WITH UPSCALE METAL BASE</b>        |                 |          |          |                                  |                  |                |                |
| 1 PIECE TOPS                                     |                 |          |          |                                  |                  |                |                |
| <p><b>FRAME ONLY AVAILABLE IN BLACK</b></p>      | 910-SQ36-MUP    | \$1,887  | \$2,061  | 35½" LONG X 35½" WIDE            | 4                | 70             | 94             |
|  | 910-SQ42-MUP    | \$1,997  | \$2,158  | 41½" LONG X 41½" WIDE            | 4                | 81             | 109            |
|  | 910-SQ48-MUP    | \$2,256  | \$2,450  | 47¼" LONG X 47¼" WIDE            | 4                | 92             | 126            |
|  | 910-SQ54-MUP    | \$2,368  | \$2,631  | 53¼" LONG X 53¼" WIDE            | 4                | 108            | 150            |
| AVAILABLE LEG FINSHES: BLACK (BL) OR CHROME (CR) |                 |          |          |                                  |                  |                |                |
| <b>RACETRACK TOP WITH UPSCALE METAL BASE</b>     |                 |          |          |                                  |                  |                |                |
| 1 PIECE TOPS                                     |                 |          |          |                                  |                  |                |                |
| <p><b>FRAME ONLY AVAILABLE IN BLACK</b></p>      | 910-RT7236-MUP  | \$2,271  | \$2,540  | 71" LONG X 35½" WIDE             | 6                | 118            | 163            |
|  | 910-RT8436-MUP  | \$2,571  | \$2,875  | 82¾" LONG X 35½" WIDE            | 8                | 139            | 197            |
|  | 910-RT9644-MUP  | \$2,790  | \$3,121  | 94½" LONG X 43½" WIDE            | 8                | 161            | 229            |
| 2 PIECE TOPS                                     |                 |          |          |                                  |                  |                |                |
| <p><b>FRAME ONLY AVAILABLE IN BLACK</b></p>      | 910-RT12048-MUP | \$3,341  | \$3,798  | 118" LONG X 47¼" WIDE (2 PIECE)  | 10               | 221            | 313            |
|  | 910-RT14448-MUP | \$3,648  | \$4,154  | 141¾" LONG X 47¼" WIDE (2 PIECE) | 12               | 268            | 381            |
|  | 910-RT15648-MUP | \$4,383  | \$4,962  | 153½" LONG X 47¼" WIDE (2 PIECE) | 12               | 285            | 403            |
|  | 910-RT16848-MUP | \$4,849  | \$5,486  | 165½" LONG X 47¼" WIDE (2 PIECE) | 12               | 301            | 427            |
|  | 910-RT19248-MUP | \$5,337  | \$6,074  | 189" LONG X 47¼" WIDE (2 PIECE)  | 14               | 333            | 472            |
| 3 PIECE TOPS                                     |                 |          |          |                                  |                  |                |                |
| <p><b>FRAME ONLY AVAILABLE IN BLACK</b></p>      | 910-RT21648-MUP | \$7,579  | \$8,757  | 212¾" LONG X 47¼" WIDE (3 PIECE) | 16               | 378            | 530            |
|  | 910-RT24048-MUP | \$7,602  | \$9,469  | 236¼" LONG X 47¼" WIDE (3 PIECE) | 18               | 411            | 576            |
|  | 910-RT26448-MUP | \$9,664  | \$10,469 | 260" LONG X 47¼" WIDE (3 PIECE)  | 20               | 443            | 621            |
|  | 910-RT28848-MUP | \$10,189 | \$10,977 | 283½" LONG X 47¼" WIDE (3 PIECE) | 22               | 475            | 666            |
| AVAILABLE LEG FINSHES: BLACK (BL) OR CHROME (CR) |                 |          |          |                                  |                  |                |                |

HIGH PRESSURE LAMINATE AVAILABLE- CONTACT CUSTOMER SERVICE FOR DETAILS.  
NOTE: WHEN ORDERING 920 SERIES, SPECIFY EDGE DETAIL (FLUTED OR NON FLUTED)

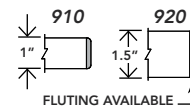

| MODEL | LIST<br>910 | LIST<br>920 | DETAILS | SEATING<br>CAPACITY | 910 WEIGHT<br>LBS | 920 WEIGHT<br>LBS |
|-------|-------------|-------------|---------|---------------------|-------------------|-------------------|
|-------|-------------|-------------|---------|---------------------|-------------------|-------------------|

## RECTANGLE TOP WITH UPSCALE METAL BASE

### 1 PIECE TOPS

|                 |         |         |                       |   |     |     |
|-----------------|---------|---------|-----------------------|---|-----|-----|
| 910-REC7236-MUP | \$2,240 | \$2,540 | 71" LONG X 35½" WIDE  | 6 | 124 | 174 |
| 910-REC8436-MUP | \$2,530 | \$2,875 | 82¾" LONG X 35½" WIDE | 8 | 145 | 205 |
| 910-REC9644-MUP | \$2,713 | \$3,121 | 94½" LONG X 43½" WIDE | 8 | 167 | 237 |

### 2 PIECE TOPS

|                  |         |         |                                  |    |     |     |
|------------------|---------|---------|----------------------------------|----|-----|-----|
| 910-REC12048-MUP | \$3,283 | \$3,798 | 118" LONG X 47¼" WIDE (2 PIECE)  | 10 | 227 | 321 |
| 910-REC14448-MUP | \$3,583 | \$4,154 | 141¾" LONG X 47¼" WIDE (2 PIECE) | 12 | 274 | 392 |
| 910-REC15648-MUP | \$4,293 | \$4,962 | 153½" LONG X 47¼" WIDE (2 PIECE) | 12 | 286 | 404 |
| 910-REC16848-MUP | \$4,753 | \$5,486 | 165½" LONG X 47¼" WIDE (2 PIECE) | 12 | 302 | 428 |
| 910-REC19248-MUP | \$5,224 | \$6,074 | 189" LONG X 47¼" WIDE (2 PIECE)  | 14 | 334 | 473 |

### 3 PIECE TOPS

|                  |         |          |                                  |    |     |     |
|------------------|---------|----------|----------------------------------|----|-----|-----|
| 910-REC21648-MUP | \$6,819 | \$8,441  | 212¾" LONG X 47¼" WIDE (3 PIECE) | 16 | 379 | 531 |
| 910-REC24048-MUP | \$8,208 | \$9,197  | 236¼" LONG X 47¼" WIDE (3 PIECE) | 18 | 412 | 577 |
| 910-REC26448-MUP | \$9,203 | \$10,137 | 260" LONG X 47¼" WIDE (3 PIECE)  | 20 | 445 | 623 |
| 910-REC28848-MUP | \$9,733 | \$10,632 | 283½" LONG X 47¼" WIDE (3 PIECE) | 22 | 477 | 668 |

AVAILABLE LEG FINSHES: BLACK (BL) OR CHROME (CR)

## BOAT TOP WITH UPSCALE METAL BASE

### 1 PIECE TOPS

|               |         |         |                                    |   |     |     |
|---------------|---------|---------|------------------------------------|---|-----|-----|
| 910-B7236-MUP | \$2,271 | \$2,540 | 71" LONG X 35½" WIDE, W/ 26½" END  | 6 | 119 | 164 |
| 910-B8436-MUP | \$2,571 | \$2,875 | 82¾" LONG X 35½" WIDE, W/ 26½" END | 8 | 140 | 198 |
| 910-B9644-MUP | \$2,790 | \$3,121 | 94½" LONG X 43½" WIDE, W/ 29½" END | 8 | 162 | 230 |

### 2 PIECE TOPS

|                |         |         |   |    |     |     |
|----------------|---------|---------|---|----|-----|-----|
| 910-B12048-MUP | \$3,341 | \$3,798 | 118" LONG X 47¼" WIDE, W/ 29½" END (2 PIECE)  | 10 | 221 | 313 |
| 910-B14448-MUP | \$3,648 | \$4,154 | 141¾" LONG X 47¼" WIDE, W/ 29½" END (2 PIECE) | 12 | 268 | 381 |
| 910-B15648-MUP | \$4,383 | \$4,962 | 153½" LONG X 47¼" WIDE, W/ 29½" END (2 PIECE) | 12 | 285 | 403 |
| 910-B16848-MUP | \$4,849 | \$5,486 | 165½" LONG X 47¼" WIDE, W/ 29½" END (2 PIECE) | 12 | 301 | 427 |
| 910-B19248-MUP | \$5,337 | \$6,074 | 189" LONG X 47¼" WIDE, W/ 29½" END (2 PIECE)  | 14 | 333 | 472 |

### 3 PIECE TOPS

|                |          |          |   |    |     |     |
|----------------|----------|----------|---|----|-----|-----|
| 910-B21648-MUP | \$7,579  | \$8,757  | 212¾" LONG X 47¼" WIDE, W/ 29½" END (3 PIECE) | 16 | 378 | 530 |
| 910-B24048-MUP | \$8,502  | \$9,469  | 236¼" LONG X 47¼" WIDE, W/ 29½" END (3 PIECE) | 18 | 411 | 576 |
| 910-B26448-MUP | \$9,664  | \$10,452 | 260" LONG X 47¼" WIDE, W/ 29½" END (3 PIECE)  | 20 | 443 | 621 |
| 910-B28848-MUP | \$10,189 | \$10,977 | 283½" LONG X 47¼" WIDE, W/ 29½" END (3 PIECE) | 22 | 475 | 666 |

AVAILABLE LEG FINSHES: BLACK (BL) OR CHROME (CR)

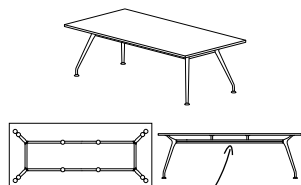

FRAME ONLY  
AVAILABLE IN BLACK

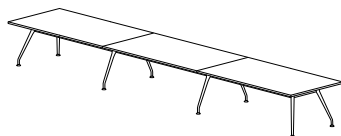

RTA

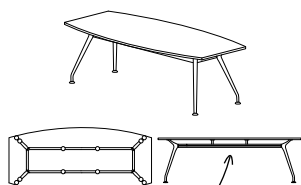

FRAME ONLY  
AVAILABLE IN BLACK

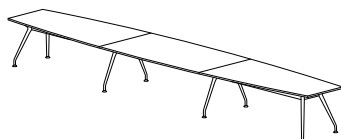

RTA

| MODEL | LIST 388 | LIST 600 | WEIGHT LBS | CUBE FT <sup>3</sup> | W IN | D IN | H 1" IN 388 | H 1½" IN 600 |
|-------|----------|----------|------------|----------------------|------|------|-------------|--------------|
|-------|----------|----------|------------|----------------------|------|------|-------------|--------------|

**BULLET AND WEDGE BULLET TABLES:**

- DESIGNED TO BE A COLLABORATE TABLE AND PUSHED UP AGAINST A WALL.
- DEFAULT FULL HEIGHT DOUBLE MODESTY PANEL RUNNERS TO HIDE WIRES
- GROMMET CENTERED NEAR TOP OF THE END PANEL FOR EASY WIRE PASS THROUGH.
- ¾ HEIGHT OR ½ HEIGHT MODESTIES ARE AVAILABLE.
- ADDITIONAL POWER GROMMETS CAN BE SURFACE MOUNTED AS AN ADD ON FEATURE, SEE ACCESSORIES SERIES **100-6** FOR OPTIONS.
- SHIPS RTA – QUICK READY TO ASSEMBLE.

SATISFY POWER AND DATA NEEDS BY ADDING AN OPTIONAL **POWER GROMMET** SEE **ACCESSORIES/ 100 SERIES 100-6**

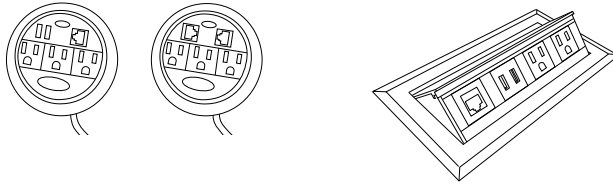

**BULLET TABLE WITH TRESTLE PANEL SET**

48" BULLET TABLE

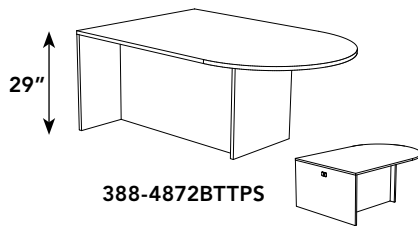

|               |         |         |       |      |       |       |    |      |
|---------------|---------|---------|-------|------|-------|-------|----|------|
| 388-4860BTTPS | \$2,864 | \$3,498 | 127.9 | 5.82 | 59.25 | 47.25 | 29 | 29.5 |
| 388-4872BTTPS | \$3,036 | \$3,706 | 145.5 | 6.94 | 71    | 47.25 | 29 | 29.5 |
| 388-4884BTTPS | \$3,327 | \$3,835 | 163.1 | 8.07 | 82.75 | 47.25 | 29 | 29.5 |
| 388-4896BTTPS | \$3,920 | \$4,765 | 180.8 | 9.19 | 94.5  | 47.25 | 29 | 29.5 |

60" BULLET TABLE

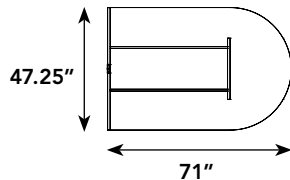

|               |         |         |       |      |       |       |    |      |
|---------------|---------|---------|-------|------|-------|-------|----|------|
| 388-6060BTTPS | \$3,490 | \$3,979 | 165.3 | 7.21 | 59.25 | 59.25 | 29 | 29.5 |
| 388-6072BTTPS | \$3,662 | \$4,175 | 185.2 | 8.61 | 71    | 59.25 | 29 | 29.5 |
| 388-6084BTTPS | \$3,952 | \$4,505 | 205   | 10   | 82.75 | 59.25 | 29 | 29.5 |
| 388-6096BTTPS | \$4,545 | \$5,181 | 224.9 | 11.4 | 94.5  | 59.25 | 29 | 29.5 |

48" BULLET TABLE - 42" HIGH

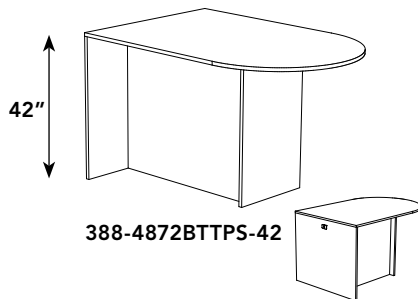

|                  |         |         |       |       |       |       |    |    |
|------------------|---------|---------|-------|-------|-------|-------|----|----|
| 388-4860BTTPS-42 | \$3,490 | \$4,123 | 138.9 | 7.9   | 59.25 | 47.25 | 42 | 42 |
| 388-4872BTTPS-42 | \$3,662 | \$4,331 | 156.5 | 9.4   | 71    | 47.25 | 42 | 42 |
| 388-4884BTTPS-42 | \$3,952 | \$4,462 | 174.2 | 10.91 | 82.75 | 47.25 | 42 | 42 |
| 388-4896BTTPS-42 | \$4,545 | \$5,390 | 191.8 | 12.44 | 94.5  | 47.25 | 42 | 42 |

60" BULLET TABLE - 42" HIGH

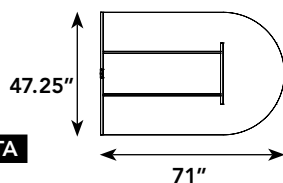

|                  |         |         |       |       |       |       |    |    |
|------------------|---------|---------|-------|-------|-------|-------|----|----|
| 388-6060BTTPS-42 | \$4,114 | \$4,690 | 176.4 | 9.76  | 59.25 | 59.25 | 42 | 42 |
| 388-6072BTTPS-42 | \$4,287 | \$4,887 | 196.2 | 11.65 | 71    | 59.25 | 42 | 42 |
| 388-6084BTTPS-42 | \$4,578 | \$5,219 | 216.1 | 13.53 | 82.75 | 59.25 | 42 | 42 |
| 388-6096BTTPS-42 | \$5,170 | \$5,894 | 235.9 | 15.42 | 94.5  | 59.25 | 42 | 42 |

**RTA**

# 388/600 TABLES

## BULLET TABLES / WEDGE BULLET TABLES

| MODEL | LIST 388 | LIST 600 | WEIGHT LBS | CUBE FT <sup>3</sup> | W IN | D IN | H 1" IN 388 | H 1½" IN 600 |
|-------|----------|----------|------------|----------------------|------|------|-------------|--------------|
|-------|----------|----------|------------|----------------------|------|------|-------------|--------------|

### BULLET TABLE WITH TRESTLE PANEL CUBE

#### 48" BULLET TABLE

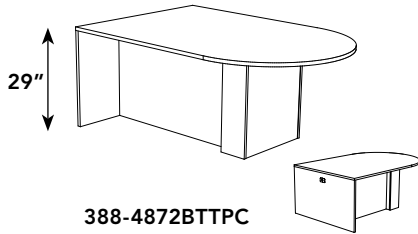

|               |         |         |        |      |       |       |    |      |
|---------------|---------|---------|--------|------|-------|-------|----|------|
| 388-4860BTTPC | \$3,176 | \$3,811 | 160.94 | 5.82 | 59.25 | 47.25 | 29 | 29.5 |
| 388-4872BTTPC | \$3,350 | \$4,020 | 178.57 | 6.94 | 71    | 47.25 | 29 | 29.5 |
| 388-4884BTTPC | \$3,638 | \$4,148 | 196.21 | 8.07 | 82.75 | 47.25 | 29 | 29.5 |
| 388-4896BTTPC | \$4,232 | \$5,078 | 213.85 | 9.19 | 94.5  | 47.25 | 29 | 29.5 |

#### 60" BULLET TABLE

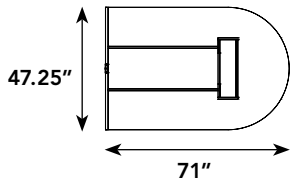

|               |         |         |        |        |       |       |    |      |
|---------------|---------|---------|--------|--------|-------|-------|----|------|
| 388-6060BTTPC | \$3,802 | \$4,334 | 198.42 | 7.21   | 59.25 | 59.25 | 29 | 29.5 |
| 388-6072BTTPC | \$3,974 | \$4,530 | 218.26 | 8.61   | 71    | 59.25 | 29 | 29.5 |
| 388-6084BTTPC | \$4,264 | \$4,861 | 238.1  | 10.003 | 82.75 | 59.25 | 29 | 29.5 |
| 388-6096BTTPC | \$4,858 | \$5,538 | 257.94 | 11.4   | 94.5  | 59.25 | 29 | 29.5 |

#### 48" BULLET TABLE - 42" HIGH

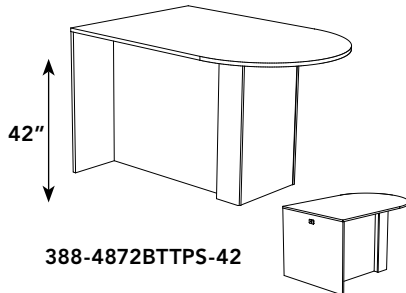

|                  |         |         |        |       |       |       |    |    |
|------------------|---------|---------|--------|-------|-------|-------|----|----|
| 388-4860BTTPC-42 | \$3,802 | \$4,436 | 171.96 | 7.87  | 59.25 | 47.25 | 42 | 42 |
| 388-4872BTTPC-42 | \$3,974 | \$4,644 | 189.6  | 9.39  | 71    | 47.25 | 42 | 42 |
| 388-4884BTTPC-42 | \$4,264 | \$4,773 | 207.23 | 10.91 | 82.75 | 47.25 | 42 | 42 |
| 388-4896BTTPC-42 | \$4,858 | \$5,703 | 224.87 | 12.44 | 94.5  | 47.25 | 42 | 42 |

#### 60" BULLET TABLE - 42" HIGH

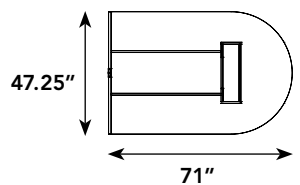

|                  |         |         |        |       |       |       |    |    |
|------------------|---------|---------|--------|-------|-------|-------|----|----|
| 388-6060BTTPC-42 | \$4,427 | \$5,047 | 209.44 | 9.76  | 59.25 | 59.25 | 42 | 42 |
| 388-6072BTTPC-42 | \$4,600 | \$5,244 | 229.28 | 11.65 | 71    | 59.25 | 42 | 42 |
| 388-6084BTTPC-42 | \$4,890 | \$5,575 | 249.12 | 13.53 | 82.75 | 59.25 | 42 | 42 |
| 388-6096BTTPC-42 | \$5,482 | \$6,249 | 268.96 | 15.42 | 94.5  | 59.25 | 42 | 42 |

- TO ORDER WITH ½ OR ¾ MODESTY PANEL - ADD '2' (½) OR '3' (¾) TO MODEL NUMBER  
EXAMPLE: 388-33672PTGM-L-2

- FOR AN OPTIONAL POWER MANAGEMENT ACCESS PANEL PLEASE ADD AN UPCHARGE OF \$436

RTA

### WEDGE BULLET TABLE WITH TRESTLE PANEL SET

#### 48" WEDGE BULLET TABLE

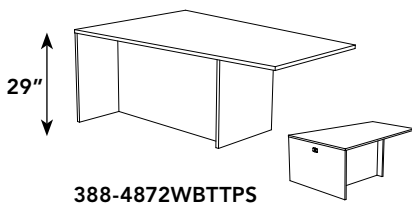

|                 |         |         |        |      |       |       |    |      |
|-----------------|---------|---------|--------|------|-------|-------|----|------|
| 388-4860WBTTTPS | \$2,864 | \$3,498 | 127.9  | 5.82 | 59.25 | 47.25 | 29 | 29.5 |
| 388-4872WBTTTPS | \$3,036 | \$3,706 | 145.5  | 6.94 | 71    | 47.25 | 29 | 29.5 |
| 388-4884WBTTTPS | \$3,327 | \$3,835 | 163.1  | 8.07 | 82.75 | 47.25 | 29 | 29.5 |
| 388-4896WBTTTPS | \$3,920 | \$4,765 | 180.78 | 9.19 | 94.5  | 47.25 | 29 | 29.5 |

#### 60" WEDGE BULLET TABLE

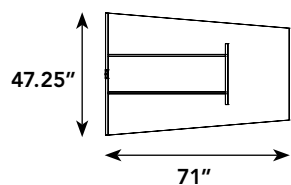

|                 |         |         |       |      |       |       |    |      |
|-----------------|---------|---------|-------|------|-------|-------|----|------|
| 388-6060WBTTTPS | \$3,490 | \$3,979 | 165.4 | 7.21 | 59.25 | 59.25 | 29 | 29.5 |
| 388-6072WBTTTPS | \$3,662 | \$4,175 | 185.2 | 8.61 | 71    | 59.25 | 29 | 29.5 |
| 388-6084WBTTTPS | \$3,952 | \$4,505 | 205.0 | 10.0 | 82.75 | 59.25 | 29 | 29.5 |
| 388-6096WBTTTPS | \$4,545 | \$5,181 | 224.9 | 11.4 | 94.5  | 59.25 | 29 | 29.5 |

| MODEL | LIST 388 | LIST 600 | WEIGHT LBS | CUBE FT <sup>3</sup> | W IN | D IN | H 1" IN 388 | H 1 1/2" IN 600 |
|-------|----------|----------|------------|----------------------|------|------|-------------|-----------------|
|-------|----------|----------|------------|----------------------|------|------|-------------|-----------------|

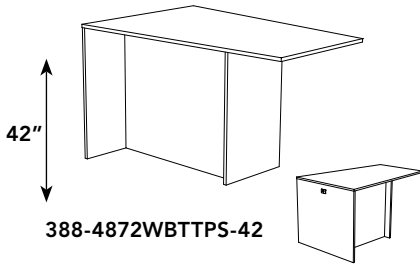

48" WEDGE BULLET TABLE - 42" HIGH

|                   |         |         |       |       |       |       |    |    |
|-------------------|---------|---------|-------|-------|-------|-------|----|----|
| 388-4860WBTTPS-42 | \$3,490 | \$4,123 | 138.9 | 7.87  | 59.25 | 47.25 | 42 | 42 |
| 388-4872WBTTPS-42 | \$3,662 | \$4,331 | 156.5 | 9.39  | 71    | 47.25 | 42 | 42 |
| 388-4884WBTTPS-42 | \$3,952 | \$4,462 | 174.2 | 10.91 | 82.75 | 47.25 | 42 | 42 |
| 388-4896WBTTPS-42 | \$4,545 | \$5,390 | 191.8 | 12.44 | 94.5  | 47.25 | 42 | 42 |

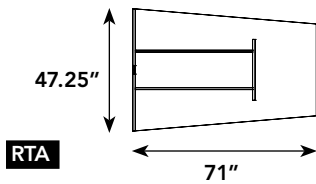

60" WEDGE BULLET TABLE - 42" HIGH

|                   |         |         |       |       |       |       |    |    |
|-------------------|---------|---------|-------|-------|-------|-------|----|----|
| 388-6060WBTTPS-42 | \$4,114 | \$4,690 | 176.4 | 9.76  | 59.25 | 59.25 | 42 | 42 |
| 388-6072WBTTPS-42 | \$4,287 | \$4,887 | 196.2 | 11.65 | 71    | 59.25 | 42 | 42 |
| 388-6084WBTTPS-42 | \$4,578 | \$5,219 | 216.1 | 13.53 | 82.75 | 59.25 | 42 | 42 |
| 388-6096WBTTPS-42 | \$5,170 | \$5,894 | 235.9 | 15.42 | 94.5  | 59.25 | 42 | 42 |

**RTA**

**WEDGE BULLET TABLE WITH TRESTLE PANEL CUBE**

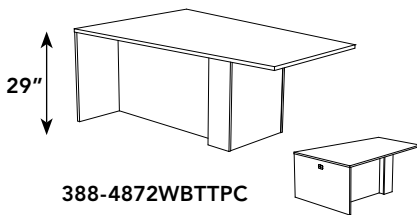

48" WEDGE BULLET TABLE

|                |         |         |       |      |       |       |    |      |
|----------------|---------|---------|-------|------|-------|-------|----|------|
| 388-4860WBTTPC | \$3,176 | \$3,811 | 160.9 | 5.82 | 59.25 | 47.25 | 29 | 29.5 |
| 388-4872WBTTPC | \$3,350 | \$4,020 | 178.6 | 6.94 | 71    | 47.25 | 29 | 29.5 |
| 388-4884WBTTPC | \$3,638 | \$4,148 | 196.2 | 8.07 | 82.75 | 47.25 | 29 | 29.5 |
| 388-4896WBTTPC | \$4,232 | \$5,078 | 213.9 | 9.19 | 94.5  | 47.25 | 29 | 29.5 |

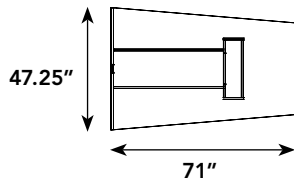

60" WEDGE BULLET TABLE

|                |         |         |       |      |       |       |    |      |
|----------------|---------|---------|-------|------|-------|-------|----|------|
| 388-6060WBTTPC | \$3,802 | \$4,334 | 198.4 | 7.21 | 59.25 | 59.25 | 29 | 29.5 |
| 388-6072WBTTPC | \$3,974 | \$4,530 | 218.3 | 8.61 | 71    | 59.25 | 29 | 29.5 |
| 388-6084WBTTPC | \$4,264 | \$4,861 | 238.1 | 10   | 82.75 | 59.25 | 29 | 29.5 |
| 388-6096WBTTPC | \$4,858 | \$5,538 | 257.9 | 11.4 | 94.5  | 59.25 | 29 |      |

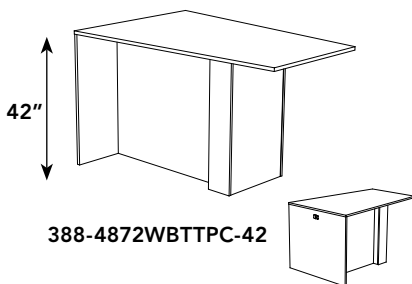

48" WEDGE BULLET TABLE - 42" HIGH

|                   |         |         |       |       |       |       |    |    |
|-------------------|---------|---------|-------|-------|-------|-------|----|----|
| 388-4860WBTTPC-42 | \$3,802 | \$4,436 | 172   | 7.87  | 59.25 | 47.25 | 42 | 42 |
| 388-4872WBTTPC-42 | \$3,974 | \$4,644 | 189.6 | 9.39  | 71    | 47.25 | 42 | 42 |
| 388-4884WBTTPC-42 | \$4,264 | \$4,773 | 207.2 | 10.91 | 82.75 | 47.25 | 42 | 42 |
| 388-4896WBTTPC-42 | \$4,858 | \$5,703 | 224.9 | 12.44 | 94.5  | 47.25 | 42 | 42 |

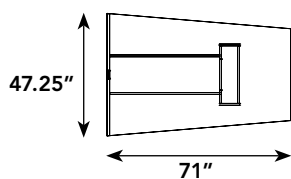

60" WEDGE BULLET TABLE - 42" HIGH

|                   |         |         |       |       |       |       |    |    |
|-------------------|---------|---------|-------|-------|-------|-------|----|----|
| 388-6060WBTTPC-42 | \$4,427 | \$5,047 | 209.4 | 9.76  | 59.25 | 59.25 | 42 | 42 |
| 388-6072WBTTPC-42 | \$4,600 | \$5,244 | 229.3 | 11.65 | 71    | 59.25 | 42 | 42 |
| 388-6084WBTTPC-42 | \$4,890 | \$5,575 | 249.1 | 13.53 | 82.75 | 59.25 | 42 | 42 |
| 388-6096WBTTPC-42 | \$5,482 | \$6,249 | 269   | 15.42 | 94.5  | 59.25 | 42 | 42 |

**RTA**

- TO ORDER WITH 1/2 OR 3/4 MODESTY PANEL - ADD '2' (1/2) OR '3' (3/4) TO MODEL NUMBER  
**EXAMPLE:** 388-33672PTGM-L-2
- FOR AN OPTIONAL POWER MANAGEMENT ACCESS PANEL PLEASE ADD AN UPCHARGE OF \$436

# 388/600 TABLES

## SHARED COMMUNITY TABLES

| MODEL | LIST 388 | LIST 600 | WEIGHT LBS | CUBE FT <sup>3</sup> | W IN | D IN | H 1" IN 388 | H 1 1/2" IN 600 |
|-------|----------|----------|------------|----------------------|------|------|-------------|-----------------|
|-------|----------|----------|------------|----------------------|------|------|-------------|-----------------|

### SHARED COMMUNITY TABLES

- 388 SERIES - 1" TOPS AND 1" GABLES. CENTERED MODESTY PANEL, HALF HEIGHT IS DEFAULT. 3/4 MODESTY AVAILABLE. NO GROMMET
- 600 SERIES - 1 1/2" TOPS AND 1 1/2" GABLES. CENTERED MODESTY PANEL, HALF HEIGHT IS DEFAULT. 3/4 MODESTY AVAILABLE. NO GROMMET

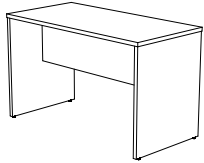

388-2448SCT

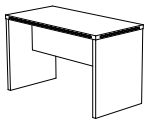

600-2448SCT

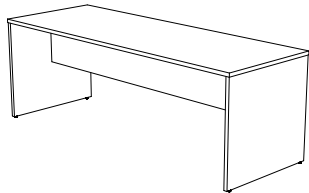

388-3084SCT

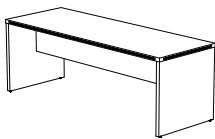

600-3084SCT

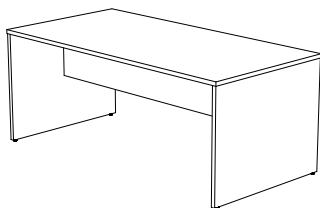

388-3672SCT

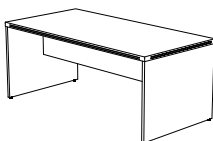

600-3672SCT

### 24" SHARED COMMUNITY TABLES

|             |         |         |       |     |       |       |    |      |
|-------------|---------|---------|-------|-----|-------|-------|----|------|
| 388-2448SCT | \$693   | \$901   | 75.1  | 2.9 | 47.25 | 23.75 | 29 | 29.5 |
| 388-2454SCT | \$724   | \$941   | 80.3  | 3.2 | 53.25 | 23.75 | 29 | 29.5 |
| 388-2460SCT | \$740   | \$962   | 85.5  | 2.7 | 59.25 | 23.75 | 29 | 29.5 |
| 388-2466SCT | \$780   | \$1,014 | 90.7  | 2.9 | 65    | 23.75 | 29 | 29.5 |
| 388-2472SCT | \$831   | \$1,080 | 95.97 | 3.2 | 71    | 23.75 | 29 | 29.5 |
| 388-2478SCT | \$946   | \$1,230 | 101.2 | 3.4 | 77    | 23.75 | 29 | 29.5 |
| 388-2484SCT | \$1,057 | \$1,374 | 106.4 | 3.7 | 82.75 | 23.75 | 29 | 29.5 |
| 388-2490SCT | \$1,146 | \$1,490 | 111.6 | 3.9 | 88.75 | 23.75 | 29 | 29.5 |
| 388-2496SCT | \$1,249 | \$1,624 | 116.8 | 4.2 | 94.5  | 23.75 | 29 | 29.5 |

### 30" SHARED COMMUNITY TABLES

|             |         |         |        |     |       |       |    |      |
|-------------|---------|---------|--------|-----|-------|-------|----|------|
| 388-3048SCT | \$755   | \$982   | 90.85  | 3.5 | 47.25 | 29.75 | 29 | 29.5 |
| 388-3054SCT | \$785   | \$1,021 | 96.96  | 3.9 | 53.25 | 29.75 | 29 | 29.5 |
| 388-3060SCT | \$801   | \$1,041 | 103.09 | 3.3 | 59.25 | 29.75 | 29 | 29.5 |
| 388-3066SCT | \$842   | \$1,095 | 109.22 | 3.6 | 65    | 29.75 | 29 | 29.5 |
| 388-3072SCT | \$893   | \$1,161 | 115.35 | 3.9 | 71    | 29.75 | 29 | 29.5 |
| 388-3078SCT | \$1,009 | \$1,312 | 121.45 | 4.2 | 77    | 29.75 | 29 | 29.5 |
| 388-3084SCT | \$1,118 | \$1,453 | 127.58 | 4.6 | 82.75 | 29.75 | 29 | 29.5 |
| 388-3090SCT | \$1,248 | \$1,622 | 133.71 | 4.9 | 88.75 | 29.75 | 29 | 29.5 |
| 388-3096SCT | \$1,338 | \$1,739 | 139.84 | 5.2 | 94.5  | 29.75 | 29 | 29.5 |

### 36" SHARED COMMUNITY TABLES

|             |         |         |        |      |       |      |    |      |
|-------------|---------|---------|--------|------|-------|------|----|------|
| 388-3648SCT | \$831   | \$1,080 | 106.59 | 4.2  | 47.25 | 35.5 | 29 | 29.5 |
| 388-3654SCT | \$873   | \$1,135 | 113.63 | 4.7  | 53.25 | 35.5 | 29 | 29.5 |
| 388-3660SCT | \$889   | \$1,156 | 120.64 | 3.9  | 59.25 | 35.5 | 29 | 29.5 |
| 388-3666SCT | \$931   | \$1,210 | 127.67 | 4.3  | 65    | 35.5 | 29 | 29.5 |
| 388-3672SCT | \$1,131 | \$1,470 | 134.70 | 4.6  | 71    | 35.5 | 29 | 29.5 |
| 388-3678SCT | \$1,168 | \$1,518 | 141.74 | 5.03 | 77    | 35.5 | 29 | 29.5 |
| 388-3684SCT | \$1,338 | \$1,739 | 148.77 | 5.4  | 82.75 | 35.5 | 29 | 29.5 |
| 388-3690SCT | \$1,380 | \$1,794 | 155.80 | 5.8  | 88.75 | 35.5 | 29 | 29.5 |
| 388-3696SCT | \$1,463 | \$1,902 | 162.83 | 6.2  | 94.5  | 35.5 | 29 | 29.5 |

| MODEL | LIST 388 | LIST 600 | WEIGHT LBS | CUBE FT <sup>3</sup> | W IN | D IN | H 1" IN 388 | H 1 1/2" IN 600 |
|-------|----------|----------|------------|----------------------|------|------|-------------|-----------------|
|-------|----------|----------|------------|----------------------|------|------|-------------|-----------------|

**SHARED COMMUNITY TABLES - 42" HIGH**

- 388 SERIES - 1" TOPS AND 1" GABLES. CENTERED MODESTY PANEL, HALF HEIGHT IS DEFAULT. 3/4 MODESTY AVAILABLE. NO GROMMET.
- 600 SERIES - 1 1/2" TOPS AND 1 1/2" GABLES. CENTERED MODESTY PANEL, HALF HEIGHT IS DEFAULT. 3/4 MODESTY AVAILABLE. NO GROMMET.

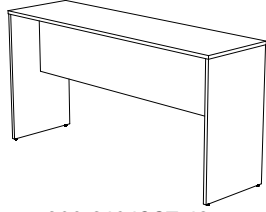

388-2484SCT-42

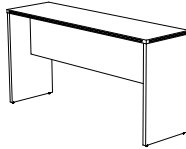

600-2484SCT-42

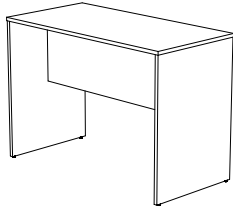

388-3060SCT-42

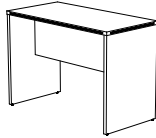

600-3060SCT-42

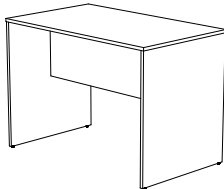

388-3660SCT-42

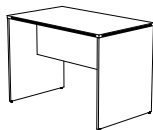

600-3660SCT-42

**24" SHARED COMMUNITY TABLES**

|                |         |         |        |      |       |       |    |    |
|----------------|---------|---------|--------|------|-------|-------|----|----|
| 388-2448SCT-42 | \$832   | \$1,082 | 96.47  | 2.87 | 47.25 | 23.75 | 42 | 42 |
| 388-2454SCT-42 | \$869   | \$1,130 | 101.7  | 3.21 | 53.25 | 23.75 | 42 | 42 |
| 388-2460SCT-42 | \$886   | \$1,152 | 106.92 | 2.67 | 59.25 | 23.75 | 42 | 42 |
| 388-2466SCT-42 | \$937   | \$1,218 | 112.13 | 2.93 | 65    | 23.75 | 42 | 42 |
| 388-2472SCT-42 | \$996   | \$1,295 | 117.35 | 3.18 | 71    | 23.75 | 42 | 42 |
| 388-2478SCT-42 | \$1,135 | \$1,476 | 122.55 | 3.4  | 77    | 23.75 | 42 | 42 |
| 388-2484SCT-42 | \$1,269 | \$1,650 | 127.78 | 3.70 | 82.75 | 23.75 | 42 | 42 |
| 388-2490SCT-42 | \$1,376 | \$1,789 | 132.98 | 3.96 | 88.75 | 23.75 | 42 | 42 |
| 388-2496SCT-42 | \$1,498 | \$1,947 | 138.21 | 4.22 | 94.5  | 23.75 | 42 | 42 |

**30" SHARED COMMUNITY TABLES**

|                |         |         |        |      |       |       |    |    |
|----------------|---------|---------|--------|------|-------|-------|----|----|
| 388-3048SCT-42 | \$906   | \$1,178 | 116.16 | 3.53 | 47.25 | 29.75 | 42 | 42 |
| 388-3054SCT-42 | \$943   | \$1,226 | 122.27 | 3.96 | 53.25 | 29.75 | 42 | 42 |
| 388-3060SCT-42 | \$961   | \$1,249 | 128.4  | 3.28 | 59.25 | 29.75 | 42 | 42 |
| 388-3066SCT-42 | \$1,011 | \$1,314 | 134.53 | 3.60 | 65    | 29.75 | 42 | 42 |
| 388-3072SCT-42 | \$1,073 | \$1,395 | 140.65 | 3.92 | 71    | 29.75 | 42 | 42 |
| 388-3078SCT-42 | \$1,212 | \$1,576 | 146.76 | 4.24 | 77    | 29.75 | 42 | 42 |
| 388-3084SCT-42 | \$1,342 | \$1,745 | 152.89 | 4.56 | 82.75 | 29.75 | 42 | 42 |
| 388-3090SCT-42 | \$1,496 | \$1,945 | 159.02 | 4.87 | 88.75 | 29.75 | 42 | 42 |
| 388-3096SCT-42 | \$1,606 | \$2,088 | 165.15 | 5.19 | 94.5  | 29.75 | 42 | 42 |

**36" SHARED COMMUNITY TABLES**

|                |         |         |        |      |       |      |    |    |
|----------------|---------|---------|--------|------|-------|------|----|----|
| 388-3648SCT-42 | \$996   | \$1,295 | 135.85 | 4.19 | 47.25 | 35.5 | 42 | 42 |
| 388-3654SCT-42 | \$1,049 | \$1,364 | 142.88 | 4.7  | 53.25 | 35.5 | 42 | 42 |
| 388-3660SCT-42 | \$1,065 | \$1,385 | 149.89 | 3.90 | 59.25 | 35.5 | 42 | 42 |
| 388-3666SCT-42 | \$1,116 | \$1,451 | 156.92 | 4.28 | 65    | 35.5 | 42 | 42 |
| 388-3672SCT-42 | \$1,357 | \$1,764 | 163.96 | 4.65 | 71    | 35.5 | 42 | 42 |
| 388-3678SCT-42 | \$1,401 | \$1,821 | 170.99 | 5.03 | 77    | 35.5 | 42 | 42 |
| 388-3684SCT-42 | \$1,606 | \$2,088 | 178.02 | 5.41 | 82.75 | 35.5 | 42 | 42 |
| 388-3690SCT-42 | \$1,657 | \$2,154 | 185.06 | 5.79 | 88.75 | 35.5 | 42 | 42 |
| 388-3696SCT-42 | \$1,755 | \$2,282 | 192.09 | 6.16 | 94.5  | 35.5 | 42 | 42 |

# 388/600 RECEPTION TABLES MAGAZINE TABLES

| MODEL | LIST 388 | LIST 600 | WEIGHT LBS | CUBE FT <sup>3</sup> | W IN | D IN | H 1" IN 388 | H 1½" IN 600 |
|-------|----------|----------|------------|----------------------|------|------|-------------|--------------|
|-------|----------|----------|------------|----------------------|------|------|-------------|--------------|

## MAGAZINE TABLE

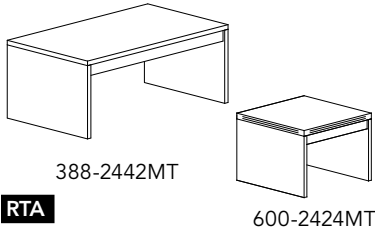

|            |       |       |    |     |       |       |       |       |
|------------|-------|-------|----|-----|-------|-------|-------|-------|
| 388-2424MT | \$398 | \$454 | 30 | 1.4 | 23.75 | 23.75 | 16.75 | 17.25 |
| 388-2442MT | \$466 | \$531 | 45 | 2.4 | 41.5  | 23.75 | 16.75 | 17.25 |

## OVAL TOP COFFEE TABLE

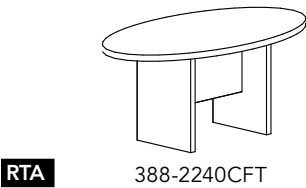

|             |       |       |    |     |      |       |       |       |
|-------------|-------|-------|----|-----|------|-------|-------|-------|
| 388-2240CFT | \$697 | \$795 | 40 | 1.4 | 39.5 | 21.75 | 16.75 | 17.25 |
|-------------|-------|-------|----|-----|------|-------|-------|-------|

## CUBE BASE MAGAZINE TABLE

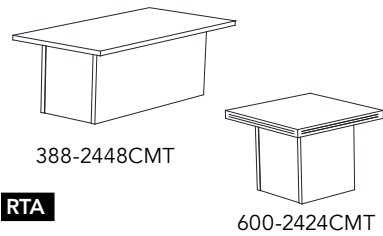

|             |       |       |    |     |       |       |       |       |
|-------------|-------|-------|----|-----|-------|-------|-------|-------|
| 388-2424CMT | \$632 | \$720 | 44 | 1.2 | 23.75 | 23.75 | 16.75 | 17.25 |
| 388-2448CMT | \$700 | \$798 | 66 | 2.4 | 47.25 | 23.75 | 16.75 | 17.25 |

## CUBE COFFEE TABLE

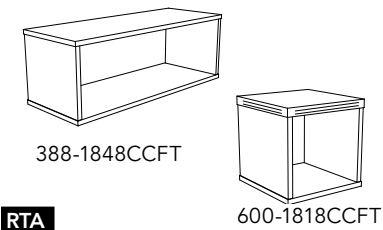

|              |       |       |       |      |       |       |       |       |
|--------------|-------|-------|-------|------|-------|-------|-------|-------|
| 388-1818CCFT | \$537 | \$746 | 31.97 | 0.97 | 17.75 | 17.75 | 16.75 | 17.25 |
| 388-1836CCFT | \$587 | \$850 | 48.5  | 1.43 | 35.5  | 17.75 | 16.75 | 17.25 |
| 388-1848CCFT | \$629 | \$915 | 59.52 | 1.88 | 47.25 | 17.75 | 16.75 | 17.25 |

- OPEN BACK DESIGN / ACCESS FROM BOTH SIDES



| MODEL | LIST | WEIGHT | CUBE            | W  | D  | H  |
|-------|------|--------|-----------------|----|----|----|
|       |      | LBS    | FT <sup>3</sup> | IN | IN | IN |

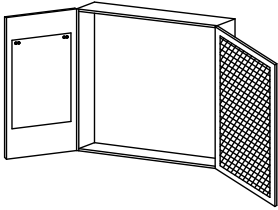

**VISUAL BOARD W/ PAPER PAD**

NON-MAGNETIC WHITEBOARD BACK. TACK BOARD ON RH DOOR, HOOKS AND PAPER PAD ON LH DOOR. MATCHING 2MM EDGE BAND ON DOOR EDGES.

|                   |                |            |          |              |          |             |
|-------------------|----------------|------------|----------|--------------|----------|-------------|
| <b>950-4646VB</b> | <b>\$1,427</b> | <b>120</b> | <b>6</b> | <b>44.75</b> | <b>6</b> | <b>45.5</b> |
|-------------------|----------------|------------|----------|--------------|----------|-------------|

- DEFAULT TACK BOARD COLOR IS HW094 MERCURY. PLEASE SPECIFY IF ANOTHER COLOR IS REQUIRED.

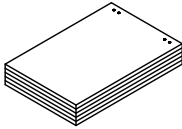

**FLIPCHART PADS FOR VISUAL BOARD**

PACK OF 5

|                      |              |           |          |          |          |  |
|----------------------|--------------|-----------|----------|----------|----------|--|
| <b>950-PAPERPADS</b> | <b>\$186</b> | <b>10</b> | <b>2</b> | <b>2</b> | <b>3</b> |  |
|----------------------|--------------|-----------|----------|----------|----------|--|

**NOTE:** HOLES FOR HOOKS AT 17" & 18" CENTERS

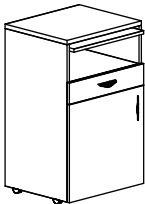

**MOBILE SERVICE CART**

1 DRAWER, 1 DOOR & PULL OUT COUNTER FOR EXTRA WORKSPACE. FRONT CASTERS LOCK. DRAWERS ARE NON-LOCKING.

|                   |                |           |           |              |              |             |
|-------------------|----------------|-----------|-----------|--------------|--------------|-------------|
| <b>950-2024SC</b> | <b>\$1,131</b> | <b>60</b> | <b>14</b> | <b>23.75</b> | <b>19.75</b> | <b>35.5</b> |
|-------------------|----------------|-----------|-----------|--------------|--------------|-------------|

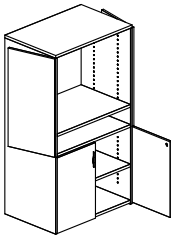

**AUDIO/VIDEO CABINET**

ADJUSTABLE SHELF IN TOP ALLOWS FOR AV EQUIPMENT LOCATION ABOVE OR BELOW TV. CABLE ACCESS IN ALL SHELVES AND BACK. TOP DOORS FOLD BACK 270° FOR UNOBSTRUCTED VIEW OF SCREEN. MAXIMUM TV DIMENSIONS - 30" W X 20" D.

|                    |                |            |           |             |              |             |
|--------------------|----------------|------------|-----------|-------------|--------------|-------------|
| <b>950-6536AVC</b> | <b>\$2,285</b> | <b>300</b> | <b>39</b> | <b>35.5</b> | <b>23.75</b> | <b>64.5</b> |
|--------------------|----------------|------------|-----------|-------------|--------------|-------------|

| MODEL | LIST | WEIGHT | CUBE            | W  | D  | H  |
|-------|------|--------|-----------------|----|----|----|
|       |      | LBS    | FT <sup>3</sup> | IN | IN | IN |

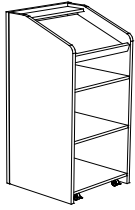

**LECTERN WITH ADJUSTABLE ANGLED TOP**

FRONT CASTERS LOCK. WIRE ACCESS IN SHELVES W/ GROMMET IN TOP.  
TOP ANGLE ADJUSTMENT OF 1°, 10° & 20°

|                    |                |            |            |              |              |           |
|--------------------|----------------|------------|------------|--------------|--------------|-----------|
| <b>950-4824LEC</b> | <b>\$1,136</b> | <b>125</b> | <b>4.5</b> | <b>23.75</b> | <b>23.75</b> | <b>48</b> |
|--------------------|----------------|------------|------------|--------------|--------------|-----------|

RTA

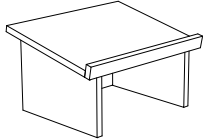

**DESKTOP LECTERN**

|                       |              |           |            |              |              |           |
|-----------------------|--------------|-----------|------------|--------------|--------------|-----------|
| <b>950-1924LEC-14</b> | <b>\$587</b> | <b>29</b> | <b>.08</b> | <b>23.75</b> | <b>18.75</b> | <b>14</b> |
|-----------------------|--------------|-----------|------------|--------------|--------------|-----------|

RTA

**388/600 BENCHES**

| MODEL | LIST       | WEIGHT | CUBE            | W  | D  | H     |
|-------|------------|--------|-----------------|----|----|-------|
|       | <b>388</b> | LBS    | FT <sup>3</sup> | IN | IN | 1" IN |

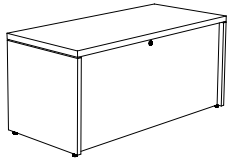

388-1836BFT-L

**FLIP TOP STORAGE BENCH**

BENCH WITH FLIP UP LID

|                    |              |             |             |              |              |              |
|--------------------|--------------|-------------|-------------|--------------|--------------|--------------|
| <b>388-1818BFT</b> | <b>\$746</b> | <b>32.2</b> | <b>0.90</b> | <b>17.75</b> | <b>17.75</b> | <b>17.25</b> |
| <b>388-2424BFT</b> | <b>\$806</b> | <b>68.8</b> | <b>1.58</b> | <b>23.75</b> | <b>23.75</b> | <b>17.25</b> |
| <b>388-1824BFT</b> | <b>\$780</b> | <b>44.6</b> | <b>1.19</b> | <b>23.75</b> | <b>17.75</b> | <b>17.25</b> |
| <b>388-1836BFT</b> | <b>\$837</b> | <b>61.9</b> | <b>1.33</b> | <b>35.5</b>  | <b>17.75</b> | <b>17.25</b> |
| <b>388-1848BFT</b> | <b>\$922</b> | <b>79.1</b> | <b>1.77</b> | <b>47.25</b> | <b>17.75</b> | <b>17.25</b> |

- TO LOCK BENCHES, ADD AN "-L" TO SKU AND AN UPCHARGE OF **\$76**  
- Example: 388-1836BFT-L
- SHIPS FULLY ASSEMBLED

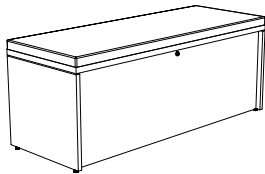

388-1848BFT-L &  
388-1848BFT-CUSH

**BENCH CUSHION**

|                         |              |             |             |              |              |             |
|-------------------------|--------------|-------------|-------------|--------------|--------------|-------------|
| <b>388-1818BFT-CUSH</b> | <b>\$393</b> | <b>8.2</b>  | <b>0.33</b> | <b>17.75</b> | <b>17.75</b> | <b>1.75</b> |
| <b>388-2424BFT-CUSH</b> | <b>\$424</b> | <b>14.5</b> | <b>0.59</b> | <b>23.75</b> | <b>23.75</b> | <b>1.75</b> |
| <b>388-1824BFT-CUSH</b> | <b>\$411</b> | <b>10.9</b> | <b>0.44</b> | <b>23.75</b> | <b>17.75</b> | <b>1.75</b> |
| <b>388-1836BFT-CUSH</b> | <b>\$467</b> | <b>16.4</b> | <b>0.66</b> | <b>35.5</b>  | <b>17.75</b> | <b>1.75</b> |
| <b>388-1848BFT-CUSH</b> | <b>\$533</b> | <b>21.8</b> | <b>0.87</b> | <b>47.25</b> | <b>17.75</b> | <b>1.75</b> |

AVAILABLE FINISHES:

ALL AVAILABLE HEARTWOOD CUSHION FABRICS

# JUPITER SERIES

This is a metric series. Please refer to page [INDEX-1](#) for details

|  |                        |
|--|------------------------|
| <b>Series Specifications &amp; Description</b> ..... | <a href="#">JUP-3</a>  |
| <b>Product by Category</b> .....                     |                        |
| Task Chairs .....                                    | <a href="#">JUP-4</a>  |
| Guest Chairs .....                                   | <a href="#">JUP-12</a> |
| Training/Nesting Chairs .....                        | <a href="#">JUP-12</a> |
| Stacking Chairs .....                                | <a href="#">JUP-14</a> |
| Stacking Bar Height Chairs .....                     | <a href="#">JUP-14</a> |
| Stacking Chair Carts .....                           | <a href="#">JUP-14</a> |
| Height Adjustable Chair .....                        | <a href="#">JUP-15</a> |
| Soft Seating .....                                   | <a href="#">JUP-16</a> |



## Jupiter

### IN-STOCK range of office seating.

- ♥ Full office seating range - task chairs, visitor chairs, height adjustable, training chairs and soft seating.
  - ♥ Over 25 easy to assemble models available.
- 

## Finishes

- ♥ Some task chair bases are available in black and chrome.
  - ♥ See price list for finish availability for each model.
- 

## Safety

- ♥ Always read and follow assembly instructions.
  - ♥ Ensure that each component is installed in the proper order.
  - ♥ Check to see that casters and pneumatic cylinders are inserted completely.
  - ♥ Annually inspect your chair for loose or worn parts.
  - ♥ Always keep the base of your chair completely on the floor.
  - ♥ Do not sit or stand on the arms of your chair.
- 

## Warranty

- ♥ The Jupiter (JUP) series offers the following warranty based on an 8 hour, single-shift work day and when user is in compliance with recommended chair weight restrictions. For individual chair weight restrictions, please refer to the specific chair model.

### Standard Warranty:

- |  |      |
|--|------|
| - Metal frames & non-moving metal parts  | 5yrs |
| - Upholstery                             | 2yrs |
| - Pneumatic cylinders                    | 3yrs |
| - Casters, bases, arms, chair mechanisms | 3yrs |

### Exceptions:

- |   |       |
|---|-------|
| Zeus Chair                              |       |
| - Metal frames & non-moving metal parts | 10yrs |
- 

## Shipping

- ♥ This is a stock product. Although every effort will be made to maintain stock at all times, we cannot guarantee availability.
- ♥ All Jupiter Series products are supplied by Heartwood Distributors (HDL)
- ♥ All items in this series ship unassembled unless noted 'FULL CARTON', in which case they will ship assembled.

**NOTE:** Information is current at time of print. For up to date information check online at [www.heartwood.ca](http://www.heartwood.ca).

| MODEL | BASE | LIST | WEIGHT | CUBE | W  | D  | H  |
|-------|------|------|--------|------|----|----|----|
|       |      |      | LBS    | FT3  | IN | IN | IN |

**ERGONOMIC 8 HOUR SEATING \***



**ECHO MID-BACK CHAIR**

- INFINITE POSITION TILT LOCK AND TILT TENSION ADJUSTMENT
- ADJUSTABLE ARMRESTS WITH SEAT DEPTH ADJUSTMENT
- AIR-FLOW MESH BACK FOR GREATER AIR CIRCULATION
- LUMBAR SUPPORT WITH PNEUMATIC SEAT HEIGHT ADJUSTMENT
- ANSI/BIFMA APPROVED CONSTRUCTION
- DUAL-WHEEL POLYURETHANE CASTERS IDEAL FOR HARD AND SOFT SURFACES

*Now featuring a thicker, more comfortable, high-density moulded foam seat cushion with higher quality fabric, manufactured to exceed 100,000 double rubs for no additional cost!*

|               |            |              |             |            |             |             |                    |
|---------------|------------|--------------|-------------|------------|-------------|-------------|--------------------|
| <b>ECO-MB</b> | BLACK BASE | <b>\$607</b> | <b>40.0</b> | <b>5.1</b> | <b>26.4</b> | <b>26.4</b> | <b>37.75-41.75</b> |
|---------------|------------|--------------|-------------|------------|-------------|-------------|--------------------|

**AVAILABLE FINISHES:**

BLACK FABRIC SEAT & BLACK MESH BACK (BL) OR  
BLUE FABRIC SEAT & GREY MESH BACK (GR) OR  
NAVY BLUE FABRIC SEAT & BLACK MESH BACK (NV) OR  
RED FABRIC SEAT & BLACK MESH BACK (RD)

|                 |            |              |             |             |             |             |                    |
|-----------------|------------|--------------|-------------|-------------|-------------|-------------|--------------------|
| <b>ECO-MBPU</b> | BLACK BASE | <b>\$625</b> | <b>40.8</b> | <b>5.26</b> | <b>26.4</b> | <b>26.4</b> | <b>37.75-41.75</b> |
|-----------------|------------|--------------|-------------|-------------|-------------|-------------|--------------------|

**AVAILABLE FINISH:** BLACK POLYURETHANE SEAT & BLACK MESH BACK (BL)

**RECOMMENDED MAX. WEIGHT CAPACITY: 300LBS**

\*TASK | MEETING SEATING



**ECHO HIGH-BACK CHAIR**

- INFINITE POSITION TILT LOCK AND TILT TENSION ADJUSTMENT
- ADJUSTABLE ARMRESTS WITH SEAT DEPTH ADJUSTMENT
- AIR-FLOW MESH BACK FOR GREATER AIR CIRCULATION
- LUMBAR SUPPORT WITH PNEUMATIC SEAT HEIGHT ADJUSTMENT
- ANSI/BIFMA APPROVED CONSTRUCTION
- DUAL-WHEEL POLYURETHANE CASTERS IDEAL FOR HARD AND SOFT SURFACES

*Now featuring a thicker, more comfortable, high-density moulded foam seat cushion with higher quality fabric, manufactured to exceed 100,000 double rubs for no additional cost!*

|               |            |              |           |             |             |             |                |
|---------------|------------|--------------|-----------|-------------|-------------|-------------|----------------|
| <b>ECO-HB</b> | BLACK BASE | <b>\$667</b> | <b>43</b> | <b>8.51</b> | <b>26.4</b> | <b>26.4</b> | <b>46-49.5</b> |
|---------------|------------|--------------|-----------|-------------|-------------|-------------|----------------|

**AVAILABLE FINISHES:**

BLACK FABRIC SEAT & BLACK MESH BACK (BL) OR  
BLUE FABRIC SEAT & GREY MESH BACK (GR) OR  
NAVY BLUE FABRIC SEAT & BLACK MESH BACK (NV) OR  
RED FABRIC SEAT & BLACK MESH BACK (RD)

|                 |            |              |           |             |             |             |                |
|-----------------|------------|--------------|-----------|-------------|-------------|-------------|----------------|
| <b>ECO-HBPU</b> | BLACK BASE | <b>\$685</b> | <b>43</b> | <b>8.51</b> | <b>26.4</b> | <b>26.4</b> | <b>46-49.5</b> |
|-----------------|------------|--------------|-----------|-------------|-------------|-------------|----------------|

**AVAILABLE FINISH:** BLACK POLYURETHANE SEAT & BLACK MESH BACK (BL)

**RECOMMENDED MAX. WEIGHT CAPACITY: 300LBS**

\*TASK | MEETING SEATING

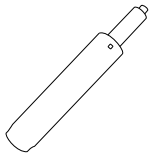

**OPTIONAL LOWER HEIGHT GAS LIFT**

|                     |  |             |  |  |  |  |  |
|---------------------|--|-------------|--|--|--|--|--|
| <b>ECO-GASLIFT2</b> |  | <b>\$52</b> |  |  |  |  |  |
|---------------------|--|-------------|--|--|--|--|--|

- ECHO STANDARD SEAT RANGE IS 16½" - 20½"H
- OPTIONAL LOWER HEIGHT GAS LIFT REDUCES THE ABOVE RANGE BY 1¼"

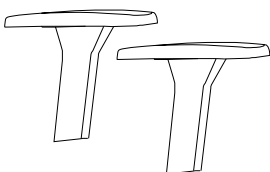

**ECHO CHAIR ADD-ONS**

|                  |              |              |            |            |  |  |  |
|------------------|--------------|--------------|------------|------------|--|--|--|
| <b>ECO-3DARM</b> | CHAIR ADD-ON | <b>\$106</b> | <b>1.1</b> | <b>0.9</b> |  |  |  |
|------------------|--------------|--------------|------------|------------|--|--|--|

- OPTIONAL 3D ARMREST SET (REPLACES EXISTING ADJUSTABLE ARMRESTS)
- 3D ADJUSTMENT INCLUDES HEIGHT ADJUSTMENT, FRONT & BACK ADJUSTMENT & 45° ROTATION

**AVAILABLE FINISH:** BLACK (BL)

| MODEL | BASE | LIST | WEIGHT | CUBE | W  | D  | H  |
|-------|------|------|--------|------|----|----|----|
|       |      |      | LBS    | FT3  | IN | IN | IN |

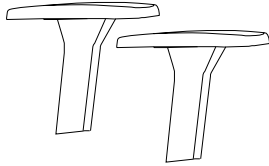

|                  |              |              |            |            |  |  |  |
|------------------|--------------|--------------|------------|------------|--|--|--|
| <b>ECO-4DARM</b> | CHAIR ADD-ON | <b>\$128</b> | <b>1.2</b> | <b>0.9</b> |  |  |  |
|------------------|--------------|--------------|------------|------------|--|--|--|

- OPTIONAL 4D ARMREST SET (REPLACES EXISTING ADJUSTABLE ARMRESTS)
- 4D ADJUSTMENT INCLUDES HEIGHT & **WIDTH** ADJUSTMENT, FRONT & BACK ADJUSTMENT & 45° ROTATION

**AVAILABLE FINISH:** BLACK (BL)

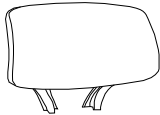

|                 |              |             |            |            |  |  |  |
|-----------------|--------------|-------------|------------|------------|--|--|--|
| <b>ECO-HDRT</b> | CHAIR ADD-ON | <b>\$59</b> | <b>0.5</b> | <b>0.3</b> |  |  |  |
|-----------------|--------------|-------------|------------|------------|--|--|--|

- OPTIONAL NON-ADJUSTABLE HEADREST FOR ECHO

**AVAILABLE FINISH:** BLACK (BL)

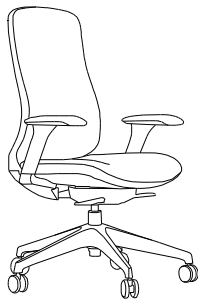

**ZEUS MID-BACK CHAIR**

- ULTRA-FINE POLYURETHANE SEAT AND BACKREST - EASY TO CLEAN
- 4 - POSITION TILT LOCK, SEAT DEPTH ADJUSTMENT AND 4D ARMRESTS
- WEIGHT-ACTIVATED SYNCHRO-TILT - MECHANISM AUTOMATICALLY ADJUSTS TO EVERY USER REGULATING THE FORCE NEEDED TO RECLINE THE CHAIR BASED ON BODY WEIGHT
- NYLON BASE
- NON-MARKING DUAL WHEEL CASTERS IDEAL FOR CARPET OR HARDWOOD, VINYL AND TILE FLOORS
- ANSI/BIFMA X5.1-2017 APPROVED CONSTRUCTION

|                  |              |             |             |                  |                    |                |
|------------------|--------------|-------------|-------------|------------------|--------------------|----------------|
| <b>ZEU-MB-BL</b> | <b>\$850</b> | <b>48.4</b> | <b>6.11</b> | <b>26.4-28.4</b> | <b>23.25-25.25</b> | <b>41-44.9</b> |
|------------------|--------------|-------------|-------------|------------------|--------------------|----------------|

**AVAILABLE FINISH:** BLACK (BL)

**RECOMMENDED MAX. WEIGHT CAPACITY: 300LBS**

|                  |              |             |             |                  |                    |                |
|------------------|--------------|-------------|-------------|------------------|--------------------|----------------|
| <b>ZEU-MB-BS</b> | <b>\$883</b> | <b>48.4</b> | <b>6.11</b> | <b>26.4-28.4</b> | <b>23.25-25.25</b> | <b>41-44.9</b> |
|------------------|--------------|-------------|-------------|------------------|--------------------|----------------|

|                  |              |             |             |                  |                    |                |
|------------------|--------------|-------------|-------------|------------------|--------------------|----------------|
| <b>ZEU-MB-DB</b> | <b>\$883</b> | <b>48.4</b> | <b>6.11</b> | <b>26.4-28.4</b> | <b>23.25-25.25</b> | <b>41-44.9</b> |
|------------------|--------------|-------------|-------------|------------------|--------------------|----------------|

|                  |              |             |             |                  |                    |                |
|------------------|--------------|-------------|-------------|------------------|--------------------|----------------|
| <b>ZEU-MB-DG</b> | <b>\$883</b> | <b>48.4</b> | <b>6.11</b> | <b>26.4-28.4</b> | <b>23.25-25.25</b> | <b>41-44.9</b> |
|------------------|--------------|-------------|-------------|------------------|--------------------|----------------|

**AVAILABLE BASE FINISH:** BLACK (BL) & GREY (GR)

**AVAILABLE SEAT FINISH:** BUTTERSCOTCH (BS), DARK BLUE (DB) AND DARK GREY (DG)

**RECOMMENDED MAX. WEIGHT CAPACITY: 300LBS**

**TASK | MEETING SEATING**

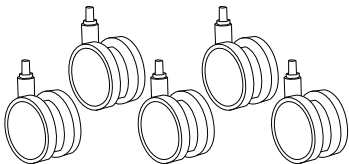

**OPTIONAL HARD SURFACE CASTER**

- 2.5" DUAL WHEEL NYLON, NON-MARKING CASTER
- SET OF 5

|                    |             |  |  |  |  |  |
|--------------------|-------------|--|--|--|--|--|
| <b>ZEU-CASTER2</b> | <b>\$24</b> |  |  |  |  |  |
|--------------------|-------------|--|--|--|--|--|

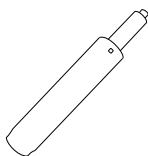

**OPTIONAL LOWER HEIGHT GAS LIFT**

|                     |             |  |  |  |  |                    |
|---------------------|-------------|--|--|--|--|--------------------|
| <b>ZEU-GASLIFT2</b> | <b>\$37</b> |  |  |  |  | <b>39.75-43.75</b> |
|---------------------|-------------|--|--|--|--|--------------------|

- ORDER SEPERATELY
- ZEUS STANDARD SEAT HEIGHT IS 19 - 22%<sup>h</sup>
- OPTIONAL LOWER HEIGHT GAS LIFT REDUCES THE ABOVE RANGE BY 1¼"

| MODEL | BASE | LIST | WEIGHT | CUBE | W  | D  | H  |
|-------|------|------|--------|------|----|----|----|
|       |      |      | LBS    | FT3  | IN | IN | IN |



**AURA MID-BACK CHAIR**

- UPHOLSTERED, HIGH DENSITY MOULDED FOAM SEAT & MESH BACK
- MULTI-POSITION TILT LOCK & TILT TENSION ADJUSTMENT
- ADJUSTABLE LUMBAR SUPPORT
- PNEUMATIC SEAT HEIGHT ADJUSTMENT
- FIXED HEIGHT POLYURETHANE PAD ARMREST
- DUAL WHEEL CASTERS, IDEAL FOR SOFT OR HARD FLOORS
- ANSI/BIFMA APPROVED CONSTRUCTION
- ASSEMBLY REQUIRED

|                  |            |              |              |              |           |              |                    |
|------------------|------------|--------------|--------------|--------------|-----------|--------------|--------------------|
| <b>AUR-MB-BL</b> | BLACK BASE | <b>\$562</b> | <b>31.97</b> | <b>5.189</b> | <b>26</b> | <b>20.25</b> | <b>39.75-43.25</b> |
|------------------|------------|--------------|--------------|--------------|-----------|--------------|--------------------|

AVAILABLE SEAT FINISH: BLACK FABRIC SEAT & BLACK MESH BACK (BL)

|                  |                 |              |              |              |           |              |                    |
|------------------|-----------------|--------------|--------------|--------------|-----------|--------------|--------------------|
| <b>AUR-MB-GR</b> | LIGHT GREY BASE | <b>\$562</b> | <b>31.97</b> | <b>5.189</b> | <b>26</b> | <b>20.25</b> | <b>39.75-43.25</b> |
|------------------|-----------------|--------------|--------------|--------------|-----------|--------------|--------------------|

AVAILABLE SEAT FINISH: LIGHT GREY FABRIC SEAT & MATCHING GREY MESH BACK (GR)

RECOMMENDED MAX. WEIGHT CAPACITY: 300LBS

TASK | MEETING SEATING



**AURA HIGH-BACK CHAIR**

- UPHOLSTERED, HIGH DENSITY MOULDED FOAM SEAT & MESH BACK
- MULTI-POSITION TILT LOCK & TILT TENSION ADJUSTMENT
- ADJUSTABLE LUMBAR SUPPORT
- PNEUMATIC SEAT HEIGHT ADJUSTMENT
- FIXED HEIGHT POLYURETHANE PAD ARMREST
- DUAL WHEEL CASTERS, IDEAL FOR SOFT OR HARD FLOORS
- ANSI/BIFMA APPROVED CONSTRUCTION
- ASSEMBLY REQUIRED
- ADJUSTABLE HEADREST
- ASSEMBLY REQUIRED

|                  |            |              |              |              |           |              |                    |
|------------------|------------|--------------|--------------|--------------|-----------|--------------|--------------------|
| <b>AUR-HB-BL</b> | BLACK BASE | <b>\$616</b> | <b>33.78</b> | <b>5.401</b> | <b>26</b> | <b>20.25</b> | <b>46.75-50.25</b> |
|------------------|------------|--------------|--------------|--------------|-----------|--------------|--------------------|

AVAILABLE SEAT FINISH: BLACK FABRIC SEAT & BLACK MESH BACK (BL)

|                  |                 |              |              |              |           |              |                    |
|------------------|-----------------|--------------|--------------|--------------|-----------|--------------|--------------------|
| <b>AUR-HB-GR</b> | LIGHT GREY BASE | <b>\$616</b> | <b>33.78</b> | <b>5.401</b> | <b>26</b> | <b>20.25</b> | <b>46.75-50.25</b> |
|------------------|-----------------|--------------|--------------|--------------|-----------|--------------|--------------------|

AVAILABLE SEAT FINISH: LIGHT GREY FABRIC SEAT & MATCHING GREY MESH BACK (GR)

RECOMMENDED MAX. WEIGHT CAPACITY: 300LBS

TASK | MEETING SEATING



**ARES HIGH-BACK CHAIR**

- CONTOURED MESH BACK & COMFORTABLE MESH SEAT
- MULTI-POSITION TILT LOCK & TILT TENSION ADJUSTMENT
- ADJUSTABLE LUMBAR SUPPORT
- PNEUMATIC SEAT HEIGHT ADJUSTMENT & SEAT DEPTH ADJUSTMENT
- ADJUSTABLE HEIGHT ARMS WITH POLYURETHANE PAD ARMRESTS
- DUAL WHEEL CASTERS, IDEAL FOR SOFT OR HARD FLOORS
- ANSI/BIFMA APPROVED CONSTRUCTION
- ASSEMBLY REQUIRED

|                  |            |              |             |            |              |              |                  |
|------------------|------------|--------------|-------------|------------|--------------|--------------|------------------|
| <b>ARE-HB-BL</b> | BLACK BASE | <b>\$694</b> | <b>40.7</b> | <b>6.3</b> | <b>26.75</b> | <b>19.75</b> | <b>46.5-50.5</b> |
|------------------|------------|--------------|-------------|------------|--------------|--------------|------------------|

AVAILABLE FINISH: BLACK MESH SEAT & BLACK MESH BACK (BL)

RECOMMENDED MAX. WEIGHT CAPACITY: 300LBS

TASK | MEETING SEATING



| MODEL | BASE | LIST | WEIGHT | CUBE | W  | D  | H  |
|-------|------|------|--------|------|----|----|----|
|       |      |      | LBS    | FT3  | IN | IN | IN |



**HERCULES HIGH-BACK CHAIR**

- COMFORTABLE HIGH DENSITY MOULDED FOAM SEAT
- ERGONOMIC CONTOURED MESH BACK
- ADAPTIVE AND ADJUSTABLE BIDIRECTIONAL LUMBAR SUPPORT
- COMFORTABLE HEADREST
- PNEUMATIC SEAT HEIGHT ADJUSTMENT
- ADJUSTABLE SEAT DEPTH
- MULTI-POSITION LOCK
- 3D ADJUSTABLE ARMS WITH POLYURETHANE PAD ARMRESTS
- DUAL WHEEL CASTERS, IDEAL FOR SOFT OR HARD FLOORS
- ANSI/BIFMA APPROVED CONSTRUCTION
- ASSEMBLY REQUIRED

|                  |            |              |             |            |             |                |                |
|------------------|------------|--------------|-------------|------------|-------------|----------------|----------------|
| <b>HCL-HB-BL</b> | BLACK BASE | <b>\$748</b> | <b>40.7</b> | <b>6.3</b> | <b>27.5</b> | <b>19.5-21</b> | <b>45.5-49</b> |
|------------------|------------|--------------|-------------|------------|-------------|----------------|----------------|

**AVAILABLE FINISH:** BLACK FABRIC SEAT & BLACK MESH BACK (BL)

**RECOMMENDED MAX. WEIGHT CAPACITY: 300LBS**

**TASK | MEETING SEATING**



**HERMES MID-BACK CHAIR**

- UPHOLSTERED, HIGH DENSITY MOULDED FOAM FABRIC SEAT & WIPEABLE MESH BACK
- WEIGHT-ACTIVATED SYNCHRO-TILT - MECHANISM AUTOMATICALLY ADJUSTS TO EVERY USER, REGULATING THE FORCE NEEDED TO RECLINE THE CHAIR BASED ON BODY WEIGHT
- MULTI-POSITION TILT LOCK
- SEAT DEPTH ADJUSTMENT
- LUMBAR SUPPORT
- PNEUMATIC SEAT HEIGHT ADJUSTMENT
- FULLY ADJUSTABLE 4 DIMENSIONAL POLYURETHANE ARMS (OPTIMAL FUNCTIONALITY)
- DUAL WHEEL CASTERS, IDEAL FOR SOFT OR HARD FLOORS
- ANSI/BIFMA APPROVED CONSTRUCTION
- ASSEMBLY REQUIRED

|                  |            |              |           |            |                    |             |                  |
|------------------|------------|--------------|-----------|------------|--------------------|-------------|------------------|
| <b>HEM-MB-BL</b> | BLACK BASE | <b>\$731</b> | <b>44</b> | <b>5.2</b> | <b>25.25-26.25</b> | <b>20.5</b> | <b>38.5-42.5</b> |
|------------------|------------|--------------|-----------|------------|--------------------|-------------|------------------|

**AVAILABLE FINISH:** BLACK FABRIC SEAT & BLACK MESH BACK (BL)

|                  |           |              |           |            |                    |             |                  |
|------------------|-----------|--------------|-----------|------------|--------------------|-------------|------------------|
| <b>HEM-MB-GR</b> | GREY BASE | <b>\$769</b> | <b>44</b> | <b>5.2</b> | <b>25.25-26.25</b> | <b>20.5</b> | <b>38.5-42.5</b> |
|------------------|-----------|--------------|-----------|------------|--------------------|-------------|------------------|

**AVAILABLE FINISH:** GREY FABRIC SEAT & GREY MESH BACK (GR)

**RECOMMENDED MAX. WEIGHT CAPACITY: 300LBS**

**TASK | MEETING SEATING**



**HERMES HIGH-BACK CHAIR**

- UPHOLSTERED, HIGH DENSITY MOULDED FOAM FABRIC SEAT & WIPEABLE MESH BACK
- WEIGHT-ACTIVATED SYNCHRO-TILT - MECHANISM AUTOMATICALLY ADJUSTS TO EVERY USER, REGULATING THE FORCE NEEDED TO RECLINE THE CHAIR BASED ON BODY WEIGHT
- MULTI-POSITION TILT LOCK
- SEAT DEPTH ADJUSTMENT
- LUMBAR SUPPORT
- PNEUMATIC SEAT HEIGHT ADJUSTMENT
- FULLY ADJUSTABLE 4 DIMENSIONAL POLYURETHANE ARMS (OPTIMAL FUNCTIONALITY)
- DUAL WHEEL CASTERS, IDEAL FOR SOFT OR HARD FLOORS
- ANSI/BIFMA APPROVED CONSTRUCTION
- ADJUSTABLE HEADREST
- ASSEMBLY REQUIRED

|                  |            |              |           |            |                    |             |              |
|------------------|------------|--------------|-----------|------------|--------------------|-------------|--------------|
| <b>HEM-HB-BL</b> | BLACK BASE | <b>\$763</b> | <b>52</b> | <b>6.1</b> | <b>25.25-26.25</b> | <b>20.5</b> | <b>47-51</b> |
|------------------|------------|--------------|-----------|------------|--------------------|-------------|--------------|

**AVAILABLE FINISH:** BLACK FABRIC SEAT & BLACK MESH BACK (BL)

|                  |           |              |           |            |                    |             |              |
|------------------|-----------|--------------|-----------|------------|--------------------|-------------|--------------|
| <b>HEM-HB-GR</b> | GREY BASE | <b>\$795</b> | <b>52</b> | <b>6.1</b> | <b>25.25-26.25</b> | <b>20.5</b> | <b>47-51</b> |
|------------------|-----------|--------------|-----------|------------|--------------------|-------------|--------------|

**AVAILABLE FINISH:** GREY FABRIC SEAT & GREY MESH BACK (GR)

**RECOMMENDED MAX. WEIGHT CAPACITY: 300LBS**

**TASK | MEETING SEATING**

| MODEL | BASE | LIST | WEIGHT | CUBE | W  | D  | H  |
|-------|------|------|--------|------|----|----|----|
|       |      |      | LBS    | FT3  | IN | IN | IN |



**NEW!**

**PAVLOS MID-BACK CHAIR - DESIGNED FOR A PETITE SIZE PERSON**

- BEST SUITED FOR PETITE SIZE PEOPLE (5FT-5IN HEIGHT OR SHORTER)
- UPHOLSTERED SEAT AND BACK, WITH INJECTED HIGH-DENSITY FOAM
- ADJUSTABLE SEAT-DEPTH AND 3D ARMRESTS
- SELF WEIGHT-ACTIVATED RECLINE (MECHANISM AUTOMATICALLY ADJUSTS TO UNIQUE USERS, REGULATING THE FORCE NEEDED TO RECLINE THE CHAIR BASED ON BODY WEIGHT)
- NON-MARKING DUAL WHEEL CASTERS, IDEAL FOR CARPET, HARDWOOD, VINYL, AND TILE FLOORS
- DURABLE NYLON BASE
- ANSI/BIFMA X5.1-2017 APPROVED CONSTRUCTION
- ASSEMBLY REQUIRED

|                  |            |              |             |            |           |           |              |
|------------------|------------|--------------|-------------|------------|-----------|-----------|--------------|
| <b>PAV-MB-CH</b> | BLACK BASE | <b>\$660</b> | <b>34.1</b> | <b>5.0</b> | <b>24</b> | <b>20</b> | <b>36-39</b> |
|------------------|------------|--------------|-------------|------------|-----------|-----------|--------------|

**AVAILABLE FINISH:** CHARCOAL GREY FABRIC SEAT & BACK (CH)

**RECOMMENDED MAX. WEIGHT CAPACITY: 275LBS**

TASK | MEETING SEATING

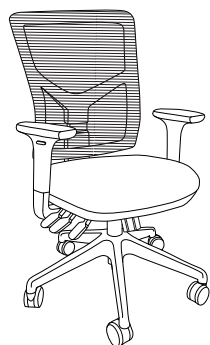

**NEW!**

**OLYMPIA MID-BACK MULTI-TILTER CHAIR**

- UPHOLSTERED SEAT AND MESH BACK MULTI-TILTER
- INFINITE POSITION TILT-LOCK AND TILT-TENSION ADJUSTMENT
- PNEUMATIC SEAT HEIGHT ADJUSTMENT
- ERGONOMICALLY DESIGNED BACK WITH LUMBAR SUPPORT
- INDEPENDENT BACK ANGLE ADJUSTMENT
- RACHET BACK HEIGHT ADJUSTMENT
- ADJUSTABLE SEAT DEPTH
- 4D HEIGHT ADJUSTABLE ARMS
- DURABLE NYLON BASE
- NON-MARKING DUAL WHEEL CASTERS, IDEAL FOR CARPET, HARDWOOD, VINYL, AND TILE FLOORS
- ANSI/BIFMA X5.1-2017 APPROVED CONSTRUCTION
- ASSEMBLY REQUIRED

|                  |            |              |             |            |              |           |                  |
|------------------|------------|--------------|-------------|------------|--------------|-----------|------------------|
| <b>OLM-MB-BL</b> | BLACK BASE | <b>\$595</b> | <b>40.7</b> | <b>6.3</b> | <b>25.75</b> | <b>21</b> | <b>40.5-46.5</b> |
|------------------|------------|--------------|-------------|------------|--------------|-----------|------------------|

**AVAILABLE FINISH:** BLACK FABRIC SEAT & BLACK MESH BACK (BL)

**RECOMMENDED MAX. WEIGHT CAPACITY: 300LBS**

TASK | MEETING SEATING



**NEW!**

**BARCELONA MID-BACK CHAIR**

- ONE-PIECE SEAT, BACK, AND FIXED-ARM FRAME
- GERMAN K&R TIGHT-KNIT MESH SEAT AND BACK
- SLEEK SWIVEL-TILT FUNCTION
- PNEUMATIC SEAT HEIGHT ADJUSTMENT WITH LOW-PROFILE GERMAN CABLE CONTROL MECHANISM
- DURABLE NYLON BASE
- DUAL WHEEL CASTERS, IDEAL FOR SOFT OR HARD FLOORS
- ANSI/BIFMA APPROVED CONSTRUCTION
- QUICK ASSEMBLY REQUIRED

|                         |            |              |           |            |             |           |                |
|-------------------------|------------|--------------|-----------|------------|-------------|-----------|----------------|
| <b>JUP-BARCELONA-BL</b> | BLACK BASE | <b>\$735</b> | <b>21</b> | <b>7.4</b> | <b>22.5</b> | <b>23</b> | <b>34.5-39</b> |
|-------------------------|------------|--------------|-----------|------------|-------------|-----------|----------------|

**AVAILABLE FINISH:** BLACK TIGHT-KNIT MESH SEAT & BACK (BL)

**RECOMMENDED MAX. WEIGHT CAPACITY: 300LBS**

TASK | MEETING SEATING

| MODEL | BASE | LIST | WEIGHT | CUBE | W  | D  | H  |
|-------|------|------|--------|------|----|----|----|
|       |      |      | LBS    | FT3  | IN | IN | IN |



**NEW!** IRIS MID-BACK CHAIR

- SLING STYLE BACK WITH ROLLED AND PLEATED DETAILS
- EASY-TO-CLEAN POLYURETHANE (PU) UPHOLSTERY, PADDED WITH COMFORTABLE HIGH-DENSITY FOAM
- PNEUMATIC SEAT HEIGHT ADJUSTMENT
- MULTI-POSITION SYNCHRO TILTER
- CHROMED ALUMINUM FIXED ARMS
- STURDY INTERNAL STEEL FRAME
- DUAL WHEEL CASTERS, IDEAL FOR SOFT OR HARD FLOORS
- ANSI/BIFMA APPROVED CONSTRUCTION
- ASSEMBLY REQUIRED

|                  |                         |              |           |            |             |             |              |
|------------------|-------------------------|--------------|-----------|------------|-------------|-------------|--------------|
| JUP-IRIS-MBPU-BL | POLISHED ALUMI-NUM BASE | <b>\$665</b> | <b>34</b> | <b>7.7</b> | <b>22.5</b> | <b>20.5</b> | <b>37-39</b> |
|------------------|-------------------------|--------------|-----------|------------|-------------|-------------|--------------|

AVAILABLE FINISH: BLACK POLYURETHANE SEAT & BACK (BL)

RECOMMENDED MAX. WEIGHT CAPACITY: 300LBS

TASK | MEETING SEATING



**NEW!** IRIS HIGH-BACK CHAIR

- SLING STYLE BACK WITH ROLLED AND PLEATED DETAILS
- EASY-TO-CLEAN POLYURETHANE (PU) UPHOLSTERY, PADDED WITH COMFORTABLE HIGH-DENSITY FOAM
- PNEUMATIC SEAT HEIGHT ADJUSTMENT
- MULTI-POSITION SYNCHRO TILTER
- CHROMED ALUMINUM FIXED ARMS
- STURDY INTERNAL STEEL FRAME
- DUAL WHEEL CASTERS, IDEAL FOR SOFT OR HARD FLOORS
- ANSI/BIFMA APPROVED CONSTRUCTION
- ASSEMBLY REQUIRED

|                  |                         |              |           |            |             |             |                  |
|------------------|-------------------------|--------------|-----------|------------|-------------|-------------|------------------|
| JUP-IRIS-HBPU-BL | POLISHED ALUMI-NUM BASE | <b>\$694</b> | <b>42</b> | <b>9.4</b> | <b>22.5</b> | <b>20.5</b> | <b>43.5-45.5</b> |
|------------------|-------------------------|--------------|-----------|------------|-------------|-------------|------------------|

AVAILABLE FINISH: BLACK POLYURETHANE SEAT & BACK (BL)

RECOMMENDED MAX. WEIGHT CAPACITY: 300LBS

TASK | MEETING SEATING



**NEW!** ARTEMIS HIGH-BACK CHAIR

- COMFORTABLE PLUSH POLYURETHANE (PU) HIGH DENSITY MOULDED FOAM SEAT & PU BACK
- MULTIFUNCTION MECHANISM WITH 5 POSITIONS TILT LOCKING
- PNEUMATIC SEAT HEIGHT ADJUSTMENT
- CHROME FRAME CONNECTING THE BACKREST AND SEAT WITH CHROME BASE
- HEIGHT ADJUSTABLE 3D ARMS WITH PU PADS
- TENSION CONTROL
- DUAL WHEEL CASTERS, IDEAL FOR SOFT OR HARD FLOORS
- ANSI/BIFMA APPROVED CONSTRUCTION
- ASSEMBLY REQUIRED

|             |             |              |           |            |                |           |                |
|-------------|-------------|--------------|-----------|------------|----------------|-----------|----------------|
| ART-HBPU-BL | CHROME BASE | <b>\$954</b> | <b>48</b> | <b>7.6</b> | <b>24-28.5</b> | <b>24</b> | <b>47.5-50</b> |
|-------------|-------------|--------------|-----------|------------|----------------|-----------|----------------|

AVAILABLE FINISH: BLACK POLYURETHANE SEAT & BACK (BL)

RECOMMENDED MAX. WEIGHT CAPACITY: 300LBS

EXECUTIVE TASK | MEETING SEATING

| MODEL | BASE | LIST | WEIGHT | CUBE | W  | D  | H  |
|-------|------|------|--------|------|----|----|----|
|       |      |      | LBS    | FT3  | IN | IN | IN |



**PENELOPE MID-BACK CHAIR**

- POLYURETHANE (PU) UPHOLSTERY WITH CHROME FRAME AND BASE
- CUSHION PADS WITH HIGH DENSITY FOAM
- CHROME FIXED ARMS
- PNEUMATIC SEAT HEIGHT ADJUSTMENT
- MULTIFUNCTION MECHANISM WITH 5 POSITIONS TILT LOCKING
- DUAL WHEEL CASTERS, IDEAL FOR SOFT OR HARD FLOORS
- ANSI/BIFMA APPROVED CONSTRUCTION
- ASSEMBLY REQUIRED

|                    |             |              |           |            |           |           |              |
|--------------------|-------------|--------------|-----------|------------|-----------|-----------|--------------|
| <b>PEN-MBPU-BL</b> | CHROME BASE | <b>\$864</b> | <b>36</b> | <b>7.3</b> | <b>23</b> | <b>25</b> | <b>42-46</b> |
|--------------------|-------------|--------------|-----------|------------|-----------|-----------|--------------|

AVAILABLE FINISH: BLACK POLYURETHANE SEAT & BACK (BL)

RECOMMENDED MAX. WEIGHT CAPACITY: 300LBS

MEETING SEATING

**NEW!**

**HYPNOS MID-BACK CHAIR**

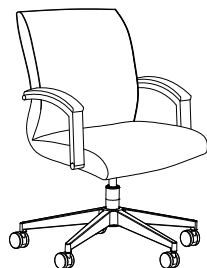

- POLYURETHANE (PU) HIGH DENSITY MOULDED FOAM SEAT & PU BACK
- MULTI-POSITION TILT LOCK & TILT TENSION ADJUSTMENT
- PNEUMATIC SEAT HEIGHT ADJUSTMENT
- CHROME FIXED HEIGHT ARMS WITH SOFT PU PAD ARMRESTS
- DUAL WHEEL CASTERS, IDEAL FOR SOFT OR HARD FLOORS
- ANSI/BIFMA APPROVED CONSTRUCTION
- ASSEMBLY REQUIRED

|                  |             |              |           |            |              |           |                    |
|------------------|-------------|--------------|-----------|------------|--------------|-----------|--------------------|
| <b>HYP-HB-BL</b> | CHROME BASE | <b>\$670</b> | <b>38</b> | <b>6.3</b> | <b>23.25</b> | <b>25</b> | <b>36.75-40.75</b> |
|------------------|-------------|--------------|-----------|------------|--------------|-----------|--------------------|

AVAILABLE FINISH: BLACK POLYURETHANE SEAT & BACK (BL)

RECOMMENDED MAX. WEIGHT CAPACITY: 300LBS

MEETING SEATING

**HYPNOS HIGH-BACK CHAIR**

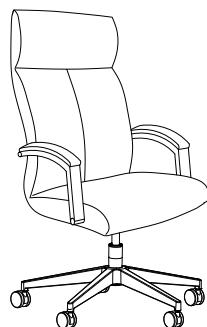

- POLYURETHANE (PU) HIGH DENSITY MOULDED FOAM SEAT & PU BACK
- MULTI-POSITION TILT LOCK & TILT TENSION ADJUSTMENT
- PNEUMATIC SEAT HEIGHT ADJUSTMENT
- CHROME FIXED HEIGHT ARMS WITH SOFT PU PAD ARMRESTS
- DUAL WHEEL CASTERS, IDEAL FOR SOFT OR HARD FLOORS
- ANSI/BIFMA APPROVED CONSTRUCTION
- ASSEMBLY REQUIRED

|                  |             |              |           |            |              |           |                    |
|------------------|-------------|--------------|-----------|------------|--------------|-----------|--------------------|
| <b>HYP-HB-BL</b> | CHROME BASE | <b>\$769</b> | <b>46</b> | <b>6.3</b> | <b>23.25</b> | <b>25</b> | <b>45.75-48.75</b> |
|------------------|-------------|--------------|-----------|------------|--------------|-----------|--------------------|

AVAILABLE FINISH: BLACK POLYURETHANE SEAT & BACK (BL)

RECOMMENDED MAX. WEIGHT CAPACITY: 300LBS

MEETING SEATING

| MODEL | BASE | LIST | WEIGHT | CUBE | W  | D  | H  |
|-------|------|------|--------|------|----|----|----|
|       |      |      | LBS    | FT3  | IN | IN | IN |



TASK SEATING

**NEW!** **PONTUS DRAFTING CHAIR**

- COMFORTABLE FABRIC SEAT CUSHION AND CONTOURED MESH BACK
- HEIGHT ADJUSTABLE 360° CHROME FOOTREST
- PNEUMATIC SEAT HEIGHT ADJUSTMENT WITH EXTENDED RANGE (7.5")
- TILT TENSION AND LOCKING MECHANISM
- NON-MARKING GLIDES (OPTIONAL DUN-SC-BL CASTERS CAN BE USED TO MAKE THE CHAIR MOBILE)
- ANSI/BIFMA APPROVED CONSTRUCTION
- ASSEMBLY REQUIRED

|                     |            |              |             |            |           |             |                    |
|---------------------|------------|--------------|-------------|------------|-----------|-------------|--------------------|
| <b>JUP-DRAFT-BL</b> | BLACK BASE | <b>\$468</b> | <b>28.4</b> | <b>4.6</b> | <b>20</b> | <b>22.5</b> | <b>41.75-49.25</b> |
|---------------------|------------|--------------|-------------|------------|-----------|-------------|--------------------|

AVAILABLE FINISH: BLACK FABRIC SEAT & BLACK MESH BACK (BL)

RECOMMENDED MAX. WEIGHT CAPACITY: 300LBS



TASK SEATING

**NEW!** **PONTUS DRAFTING CHAIR WITH ARMRESTS**

- COMFORTABLE FABRIC SEAT CUSHION AND CONTOURED MESH BACK
- HEIGHT ADJUSTABLE 360° CHROME FOOTREST
- PNEUMATIC SEAT HEIGHT ADJUSTMENT WITH EXTENDED RANGE (7.5")
- TILT TENSION AND LOCKING MECHANISM
- NON-MARKING GLIDES (OPTIONAL DUN-SC-BL CASTERS CAN BE USED TO MAKE THE CHAIR MOBILE)
- ANSI/BIFMA APPROVED CONSTRUCTION
- ASSEMBLY REQUIRED

|                          |            |              |             |            |              |             |                    |
|--------------------------|------------|--------------|-------------|------------|--------------|-------------|--------------------|
| <b>JUP-DFT-W-ARMS-BL</b> | BLACK BASE | <b>\$490</b> | <b>32.8</b> | <b>4.6</b> | <b>24.75</b> | <b>22.5</b> | <b>41.75-49.25</b> |
|--------------------------|------------|--------------|-------------|------------|--------------|-------------|--------------------|

AVAILABLE FINISH: BLACK FABRIC SEAT & BLACK MESH BACK (BL)

RECOMMENDED MAX. WEIGHT CAPACITY: 300LBS



**OPTIONAL DUNE STANDARD CASTER**

- STANDARD DUAL-WHEEL CASTERS
- SOLD INDIVIDUALLY - ORDER 5 PER CHAIR

|                  |  |             |  |  |  |  |  |
|------------------|--|-------------|--|--|--|--|--|
| <b>DUN-SC-BL</b> |  | <b>\$15</b> |  |  |  |  |  |
|------------------|--|-------------|--|--|--|--|--|

AVAILABLE FINISH: BLACK (BL)



TASK SEATING

**HERA MID-BACK TASK CHAIR - QUANTITY 2**

\* SOLD IN QUANTITIES OF 2. PRICE IS PER CARTON OF 2

- BLACK MESHED BACK FOR GREATER AIR CIRCULATION AND COMFORT
- PNEUMATIC SEAT HEIGHT ADJUSTMENT
- LOOP ARMRESTS
- TILT-TENSION ADJUSTMENT
- ANSI/BIFMA APPROVED CONSTRUCTION
- BLACK HOODED NYLON CASTERS IDEAL FOR HARD SURFACES

|               |            |                          |             |            |           |           |              |
|---------------|------------|--------------------------|-------------|------------|-----------|-----------|--------------|
| <b>HER-MB</b> | BLACK BASE | <b>*\$698 (\$349/PC)</b> | <b>46.0</b> | <b>5.8</b> | <b>23</b> | <b>19</b> | <b>37-41</b> |
|---------------|------------|--------------------------|-------------|------------|-----------|-----------|--------------|

AVAILABLE FINISH: BLACK FABRIC SEAT & BLACK MESH BACK (BL)

RECOMMENDED MAX. WEIGHT CAPACITY: 250LBS

| MODEL | BASE | LIST | WEIGHT | CUBE | W  | D  | H  |
|-------|------|------|--------|------|----|----|----|
|       |      |      | LBS    | FT3  | IN | IN | IN |

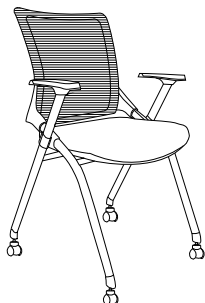

NESTING TRAINING | GUEST

**HADES NESTING GUEST/TRAINING CHAIR - QUANTITY 2**

\*SOLD IN QUANTITIES OF 2. PRICE IS PER CARTON OF 2

- CONTOURED MESH BACK WITH FABRIC SEAT
- FLIP-UP SEAT FOR EASY STORAGE & NESTING
- DURABLE GREY STEEL FRAME
- DUAL WHEEL CASTERS, IDEAL FOR SOFT OR HARD FLOORS
- BLACK POLYURETHANE PAD ARMRESTS
- ASSEMBLY REQUIRED

|            |           |                          |           |            |             |              |             |
|------------|-----------|--------------------------|-----------|------------|-------------|--------------|-------------|
| <b>HAD</b> | GREY BASE | <b>*\$996 (\$498/PC)</b> | <b>42</b> | <b>5.8</b> | <b>24.5</b> | <b>22.75</b> | <b>34.5</b> |
|------------|-----------|--------------------------|-----------|------------|-------------|--------------|-------------|

AVAILABLE FINISH: BLACK FABRIC SEAT & BLACK MESH BACK (BL)

RECOMMENDED MAX. WEIGHT CAPACITY: 275LBS

**NEW!**

**EROS GUEST CHAIR - QUANTITY 2**

\*SOLD IN QUANTITIES OF 2. PRICE IS PER CARTON OF 2

- CONTOURED SEAT CUSHION WITH WATERFALL FRONT EDGE AND MESH BACK
- STACKABLE FOR EASY STORAGE
- HEAVY-DUTY CANTILEVER CHROME BASE
- POLYURETHANE (PU) CONTOURED ARM CAPS
- NON-MARKING GLIDES
- ANSI/BIFMA APPROVED CONSTRUCTION
- QUICK ASSEMBLY REQUIRED

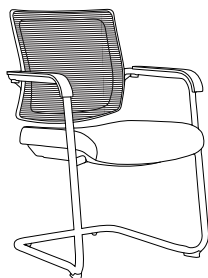

|                     |             |                          |           |            |           |             |           |
|---------------------|-------------|--------------------------|-----------|------------|-----------|-------------|-----------|
| <b>JUP-GUEST-BL</b> | CHROME BASE | <b>*\$890 (\$445/PC)</b> | <b>25</b> | <b>7.4</b> | <b>22</b> | <b>23.5</b> | <b>35</b> |
|---------------------|-------------|--------------------------|-----------|------------|-----------|-------------|-----------|

AVAILABLE FINISH: BLACK FABRIC SEAT & BLACK MESH BACK (BL)

|                        |             |                          |           |            |           |             |           |
|------------------------|-------------|--------------------------|-----------|------------|-----------|-------------|-----------|
| <b>JUP-GUEST-PU-BL</b> | CHROME BASE | <b>*\$890 (\$445/PC)</b> | <b>25</b> | <b>7.4</b> | <b>22</b> | <b>23.5</b> | <b>35</b> |
|------------------------|-------------|--------------------------|-----------|------------|-----------|-------------|-----------|

AVAILABLE FINISH: BLACK POLYURETHANE SEAT & BLACK MESH BACK (BL)

RECOMMENDED MAX. WEIGHT CAPACITY: 325LBS

STACKING TRAINING | GUEST

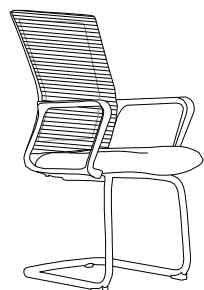

GUEST SEATING

**LEXI MESH-BACK GUEST CHAIR - QUANTITY 2**

\* SOLD IN QUANTITIES OF 2.PRICE IS PER CARTON OF 2.

- BLACK MESHED BACK FOR GREATER AIR CIRCULATION AND COMFORT
- LOOP ARMRESTS
- STURDY 14 GAUGE TUBE FRAME
- ANSI/BIFMA APPROVED CONSTRUCTION

|               |            |                          |             |            |           |           |             |
|---------------|------------|--------------------------|-------------|------------|-----------|-----------|-------------|
| <b>LEX-GU</b> | BLACK BASE | <b>*\$644 (\$322/PC)</b> | <b>42.0</b> | <b>5.3</b> | <b>23</b> | <b>19</b> | <b>36.5</b> |
|---------------|------------|--------------------------|-------------|------------|-----------|-----------|-------------|

AVAILABLE FINISH: BLACK MESH WITH BLACK FABRIC SEAT (BL)

RECOMMENDED MAX. WEIGHT CAPACITY: 250LBS

| MODEL | BASE | LIST | WEIGHT | CUBE | W  | D  | H  |
|-------|------|------|--------|------|----|----|----|
|       |      |      | LBS    | FT3  | IN | IN | IN |

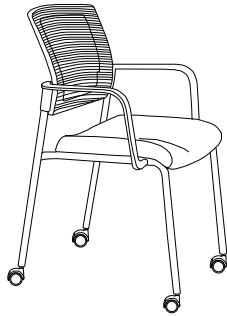

GUEST SEATING  
Shown - DUN-GUFA-02

**DUNE GUEST CHAIR**

- BLACK MESH BACK CAN BE COMBINED WITH YOUR CHOICE OF FABRIC OR POLYURETHANE SEAT CUSHION
- MODELS AVAILABLE WITH CASTERS, WEIGHTED CASTERS (CASTERS LOCK WHEN SITTING & UNLOCK WHEN STANDING) OR NON-MARKING FEET
- ARMRESTS OR WITHOUT ARMRESTS OPTIONS AVAILABLE
- 14 GAUGE, ONE PIECE POWDER COATED STEEL FRAME CONSTRUCTION
- SEAT CUSHION INSTALLATION REQUIRED (4 SCREWS)
- QUICK ASSEMBLY
- CHAIRS STACK - 5 UNITS HIGH

RECOMMENDED MAX. WEIGHT CAPACITY: 300LBS

**BASE MODELS**

**DUNE CHAIR WITH STANDARD BLACK MESH BACK, FABRIC SEAT & ARMRESTS**

|               |              |       |    |      |    |      |      |
|---------------|--------------|-------|----|------|----|------|------|
| DUN-GUFA-XX** | SEE OP-TIONS | \$411 | 30 | 13.4 | 23 | 22.5 | 34.5 |
|---------------|--------------|-------|----|------|----|------|------|

AVAILABLE SEAT FINISHES: BLACK (BL), BLUE (BU), LIGHT GREY (GR), RED (RD) & ORANGE (OR)

**DUNE CHAIR WITH STANDARD BLACK MESH BACK, POLYURETHANE SEAT & ARMRESTS**

|               |              |       |    |      |    |      |      |
|---------------|--------------|-------|----|------|----|------|------|
| DUN-GUPU-XX** | SEE OP-TIONS | \$411 | 30 | 13.4 | 23 | 22.5 | 34.5 |
|---------------|--------------|-------|----|------|----|------|------|

AVAILABLE SEAT FINISHES: BLACK POLYURETHANE (BL)

**\*\*ORDER OPTIONS:**

- 01 STANDARD CASTERS
- 02 WEIGHT ACTIVATED BRAKING CASTERS
- 03 NON-MARKING FEET

**EXAMPLE:** DUN-GUFA-02-BU ORDERS DUNE CHAIR WITH BLUE FABRIC SEAT & WEIGHTED CASTERS.

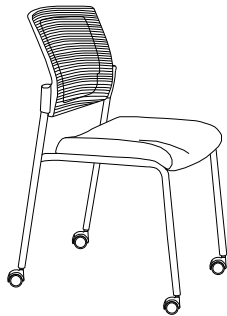

GUEST SEATING  
Shown - DUN-GUFA-05

**DUNE CHAIR WITH STANDARD BLACK MESH BACK, FABRIC SEAT WITHOUT ARMRESTS**

|               |              |       |    |      |    |      |      |
|---------------|--------------|-------|----|------|----|------|------|
| DUN-GUFA-XX** | SEE OP-TIONS | \$372 | 27 | 11.5 | 19 | 22.5 | 34.5 |
|---------------|--------------|-------|----|------|----|------|------|

AVAILABLE SEAT FINISHES: BLACK (BL), BLUE (BU), LIGHT GREY (GR), RED (RD) & ORANGE (OR)

**DUNE CHAIR WITH STANDARD BLACK MESH BACK, POLYURETHANE SEAT WITHOUT ARMRESTS**

|               |              |       |    |      |    |      |      |
|---------------|--------------|-------|----|------|----|------|------|
| DUN-GUPU-XX** | SEE OP-TIONS | \$372 | 27 | 11.5 | 19 | 22.5 | 34.5 |
|---------------|--------------|-------|----|------|----|------|------|

AVAILABLE SEAT FINISH BLACK POLYURETHANE (BL)

**\*\*ORDER OPTIONS:**

- 04 STANDARD CASTERS
- 05 WEIGHT ACTIVATED BRAKING CASTERS
- 06 NON-MARKING FEET

**EXAMPLE:** DUN-GUPU-05-BL ORDERS DUNE CHAIR WITH BLACK POLYURETHANE SEAT & WEIGHTED CASTERS.

| MODEL | BASE | LIST | WEIGHT | CUBE | W  | D  | H  |
|-------|------|------|--------|------|----|----|----|
|       |      |      | LBS    | FT3  | IN | IN | IN |

**NEW!** ZUMA TABLE HEIGHT CHAIR

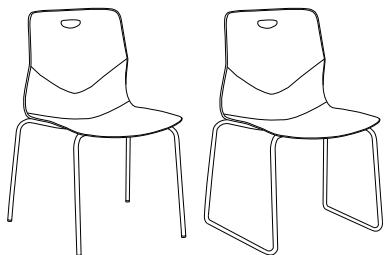

- \*SOLD IN QUANTITIES OF 4 - PRICE IS PER CARTON OF 4
- 14 GAUGE, ONE PIECE STEEL FRAME (POWDER-COATED ON ZUM-MB & CHROME ON ZUM-MB-SLED)
- COMFORTABLE, CONTOUR SHAPED BACK & SEAT MADE FROM DURABLE POLYPROPYLENE
- NON-MARKING FEET
- CHAIRS STACK - 10 UNITS HIGH
- INCLUDES HAND-HOLD FOR EASIER STACKING
- QUICK ASSEMBLY (4 SCREWS FOR SEAT)
- OPTIONAL SEAT CUSHION (SOLD SEPARATELY)
- SEAT HEIGHT 17.5"

|             |                           |      |     |      |      |       |
|-------------|---------------------------|------|-----|------|------|-------|
| ZUM-MB      | <b>*\$1060 (\$265/PC)</b> | 49.6 | 7.3 | 20.5 | 21.5 | 33.25 |
| ZUM-MB-SLED | <b>*\$1100 (\$275/PC)</b> | 49.6 | 7.3 | 20.5 | 21.5 | 33.25 |

RECOMMENDED MAX. WEIGHT CAPACITY: 300LBS

AVAILABLE FINISHES:

BLACK (BL) & DOVE WHITE (WH)

STACKING GUEST

**NEW!** ZUMA COUNTER HEIGHT CHAIR WITH SLED BASE

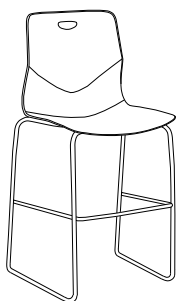

- \*SOLD IN QUANTITIES OF 4 - PRICE IS PER CARTON OF 4
- 14 GAUGE, ONE PIECE CHROME FRAME
- COMFORTABLE, CONTOUR SHAPED BACK & SEAT MADE FROM DURABLE POLYPROPYLENE
- NON-MARKING FEET
- CHAIRS STACK - 10 UNITS HIGH
- INCLUDES HAND-HOLD FOR EASIER STACKING
- QUICK ASSEMBLY (4 SCREWS FOR SEAT)
- OPTIONAL SEAT CUSHION (SOLD SEPARATELY)
- SEAT HEIGHT 23.5"

|               |                              |      |      |    |      |    |
|---------------|------------------------------|------|------|----|------|----|
| ZUM-CNTR-SLED | <b>*\$1285 (\$321.25/PC)</b> | 57.9 | 10.4 | 21 | 22.5 | 39 |
|---------------|------------------------------|------|------|----|------|----|

RECOMMENDED MAX. WEIGHT CAPACITY: 300LBS

AVAILABLE FINISHES:

BLACK (BL) & DOVE WHITE (WH)

STACKING GUEST

**NEW!** ZUMA BAR HEIGHT CHAIR

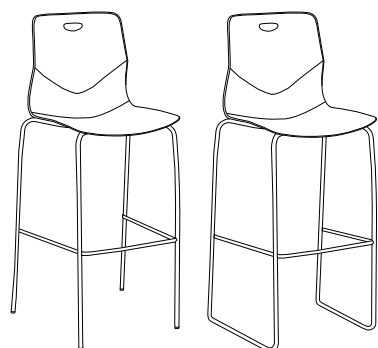

- \*SOLD IN QUANTITIES OF 4 - PRICE IS PER CARTON OF 4
- 14 GAUGE, ONE PIECE STEEL FRAME (POWDER-COATED ON ZUM-BAR & CHROME ON ZUM-BAR-SLED)
- COMFORTABLE, CONTOUR SHAPED BACK & SEAT MADE FROM DURABLE POLYPROPYLENE
- NON-MARKING FEET
- CHAIRS STACK - 10 UNITS HIGH
- INCLUDES HAND-HOLD FOR EASIER STACKING
- QUICK ASSEMBLY (4 SCREWS FOR SEAT)
- OPTIONAL SEAT CUSHION (SOLD SEPARATELY)
- SEAT HEIGHT 29.5"

|              |                           |      |      |    |      |    |
|--------------|---------------------------|------|------|----|------|----|
| ZUM-BAR      | <b>*\$1328 (\$332/PC)</b> | 66.2 | 13.5 | 21 | 22.5 | 45 |
| ZUM-BAR-SLED | <b>*\$1380 (\$345/PC)</b> | 66.2 | 13.5 | 21 | 22.5 | 45 |

RECOMMENDED MAX. WEIGHT CAPACITY: 300LBS

AVAILABLE FINISHES:

BLACK (BL) & DOVE WHITE (WH)

STACKING GUEST

**NEW!** ZUMA TABLE HEIGHT CHAIR WITH TASK BASE

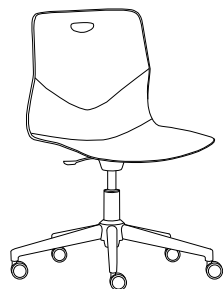

- \*SOLD IN QUANTITIES OF 4 - PRICE IS PER CARTON OF 4
- COMFORTABLE, CONTOUR SHAPED BACK & SEAT MADE FROM DURABLE POLYPROPYLENE
- PNEUMATIC SEAT HEIGHT ADJUSTMENT
- DUAL WHEEL CASTERS, IDEAL FOR SOFT OR HARD FLOORS
- QUICK ASSEMBLY (4 SCREWS FOR SEAT)
- OPTIONAL SEAT CUSHION (SOLD SEPARATELY)
- SEAT HEIGHT 17.5-23"

|             |                           |      |      |      |      |             |
|-------------|---------------------------|------|------|------|------|-------------|
| ZUM-MB-TASK | <b>*\$1380 (\$345/PC)</b> | 85.8 | 6.36 | 20.5 | 21.5 | 33.25-38.75 |
|-------------|---------------------------|------|------|------|------|-------------|

RECOMMENDED MAX. WEIGHT CAPACITY: 300LBS

AVAILABLE FINISHES:

BLACK (BL) & DOVE WHITE (WH)

TASK | GUEST



| MODEL | BASE | LIST | WEIGHT | CUBE | W  | D  | H  |
|-------|------|------|--------|------|----|----|----|
|       |      |      | LBS    | FT3  | IN | IN | IN |

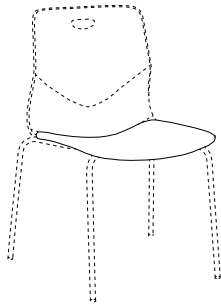

FULL CARTON

**NEW! ZUMA SEAT CUSHION**

\*SOLD IN QUANTITIES OF 4 - PRICE IS PER CARTON OF 4

- OPTIONAL CUSHION FOR ZUMA CHAIRS
- DURABLE POLYESTER FABRIC (CUSH) / DURABLE POLYURETHANE FABRIC (CUSHPU)

|                            |  |                         |  |            |             |              |             |
|----------------------------|--|-------------------------|--|------------|-------------|--------------|-------------|
| <b>ZUM-CUSH</b>            |  | <b>*\$236 (\$59/PC)</b> | <b>9.5</b>   | <b>0.7</b> | <b>18.5</b> | <b>18.25</b> | <b>0.75</b> |
| <b>AVAILABLE FINISHES:</b> |  |                         | BLACK (BL), BLUE (BU), LIGHT GREY (GR), RED (RD) & ORANGE (OR) |            |             |              |             |
| <b>ZUM-CUSHPU</b>          |  | <b>*\$236 (\$59/PC)</b> | <b>9.5</b>   | <b>0.7</b> | <b>18.5</b> | <b>18.25</b> | <b>0.75</b> |
| <b>AVAILABLE FINISHES:</b> |  |                         | BLACK (BL) & GREY (GR)   |            |             |              |             |

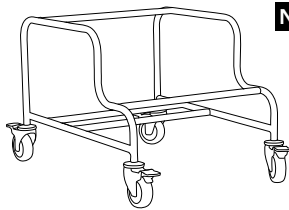

FULL CARTON

**NEW! MOBILE CART FOR ZUMA SLED BASE CHAIRS**

- STORAGE CART HOLDS UP TO 25 ZUM-MB-SLED OR 8 ZUM-BAR-SLED CHAIRS
- LOCKING, LARGE PROFILE, CASTERS FOR EASY MOVEMENT
- ONLY COMPATIBLE WITH SLED-BASE ZUMA CHAIRS

|                          |  |              |                        |            |           |           |           |
|--------------------------|--|--------------|------------------------|------------|-----------|-----------|-----------|
| <b>ZUM-SLED-CART-BL</b>  |  | <b>\$385</b> | <b>26</b>              | <b>9.5</b> | <b>30</b> | <b>25</b> | <b>22</b> |
| <b>AVAILABLE FINISH:</b> |  |              | BLACK POWDER COAT (BL) |            |           |           |           |

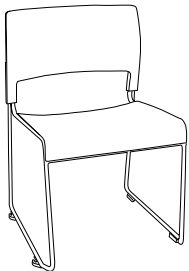

STACKING GUEST SEATING  
FULL CARTON

**ODESSA STACKING CHAIR 2.0**

SOLD IN QTY 1

- STACK UP TO 40 ODESSA CHAIRS ON OPTIONAL ODESSA CHAIR CART **ODE-CART2**
- 16 GAUGE, CHROME TUBE FRAME
- DURABLE POLYPROPYLENE SEAT & BACK
- MEETS OR EXCEEDS BIFMA APPROVED CONSTRUCTION
- SHIPS FULLY ASSEMBLED
- GANG TOGETHER - INCLUDES GANGING CLIPS ON FEET

|                 |             |              |            |             |              |              |              |
|-----------------|-------------|--------------|------------|-------------|--------------|--------------|--------------|
| <b>ODE-STK2</b> | CHROME BASE | <b>\$186</b> | <b>8.4</b> | <b>6.34</b> | <b>18.25</b> | <b>20.25</b> | <b>30.25</b> |
|-----------------|-------------|--------------|------------|-------------|--------------|--------------|--------------|

**RECOMMENDED MAX. WEIGHT CAPACITY: 300LBS**

**AVAILABLE FINISH:** BLACK (BL)

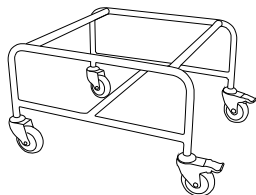

FULL CARTON

**ODESSA CHAIR CART 2.0**

OPTIONAL ODESSA CHAIR CART FOR **ODE-STK2**

- SHIPS FULLY ASSEMBLED
- STORAGE CART HOLDS UP TO 40 ODE-STK2 CHAIRS
- LOCKING, INDUSTRIAL CASTERS

|                  |  |              |             |             |              |              |              |
|------------------|--|--------------|-------------|-------------|--------------|--------------|--------------|
| <b>ODE-CART2</b> |  | <b>\$281</b> | <b>17.6</b> | <b>5.97</b> | <b>23.75</b> | <b>25.75</b> | <b>15.75</b> |
|------------------|--|--------------|-------------|-------------|--------------|--------------|--------------|

**RECOMMENDED MAX. WEIGHT CAPACITY: 330LBS**

**AVAILABLE FINISH:** BLACK POWDER COAT (BL)

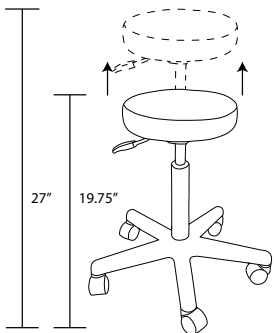

HEIGHT ADJUSTABLE

**NEW! MOBILE STOOL**

- PREMIUM EASY-TO-CLEAN POLYURETHANE COVERED HIGH-DENSITY FOAM SEAT
- EASY-TO-LIFT GAS LIFT MECHANISM
- TUCKS AWAY UNDER WORKSURFACES FOR STORAGE
- DUAL WHEEL CASTERS, IDEAL FOR SOFT OR HARD FLOORS
- QUICK ASSEMBLY REQUIRED

|                           |            |              |            |            |             |             |                 |
|---------------------------|------------|--------------|------------|------------|-------------|-------------|-----------------|
| <b>JUP-MOBILESTOOL-BL</b> | BLACK BASE | <b>\$327</b> | <b>9.8</b> | <b>1.7</b> | <b>11.5</b> | <b>11.5</b> | <b>19.75-27</b> |
|---------------------------|------------|--------------|------------|------------|-------------|-------------|-----------------|

**RECOMMENDED MAX. WEIGHT CAPACITY: 300LBS**

**AVAILABLE FINISH:** EASY-CLEAN POLYURETHANE BLACK (BL)

| MODEL | BASE | LIST | WEIGHT | CUBE | W  | D  | H  |
|-------|------|------|--------|------|----|----|----|
|       |      |      | LBS    | FT3  | IN | IN | IN |

**PLUTO HEIGHT ADJUSTABLE STOOL**

- COMPATIBLE WITH HEIGHT ADJUSTABLE WORKSTATIONS BY SUPPORTING YOUR WEIGHT, TAKING THE LOAD OFF YOUR LEGS AND GIVING YOU A REST FROM STANDING
- PREMIUM EASY-TO-CLEAN POLYURETHANE COVERED HIGH-DENSITY CUSTOM-MOULDED FOAM SEAT
- ROCK, SWIVEL, AND TILT UP TO 10 DEGREES WHILE SITTING
- RESTS UPRIGHT WHEN NOT IN USE
- DOES NOT REQUIRE CONSTANT BALANCING
- STABLE NYLON BASE WITH ANTI-SLIDE PVC GLIDER AND DUSTPROOF/DIRTPROOF COVER
- SECURELY GRIPS MOST FLOOR SURFACES INCLUDING CARPET, WOOD, AND TILE
- EASY-TO-LIFT GAS LIFT MECHANISM
- QUICK ASSEMBLY REQUIRED

|                 |            |              |             |            |             |             |              |
|-----------------|------------|--------------|-------------|------------|-------------|-------------|--------------|
| <b>PLU-HAPU</b> | BLACK BASE | <b>\$453</b> | <b>19.6</b> | <b>1.8</b> | <b>14.5</b> | <b>14.5</b> | <b>19-27</b> |
|-----------------|------------|--------------|-------------|------------|-------------|-------------|--------------|

**RECOMMENDED MAX. WEIGHT CAPACITY: 330LBS**

**AVAILABLE FINISH:**

EASY-CLEAN POLYURETHANE BLACK (BL)

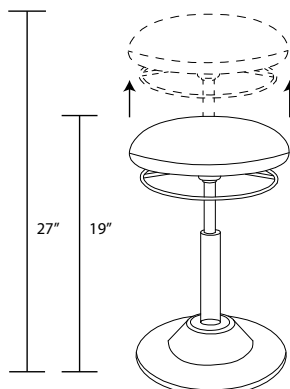

HEIGHT ADJUSTABLE

**SOFT SEATING**

1 SEATER COUCH/CHAIR

|                  |               |             |             |           |             |           |
|------------------|---------------|-------------|-------------|-----------|-------------|-----------|
| <b>COU-1SEAT</b> | <b>\$1227</b> | <b>52.9</b> | <b>15.9</b> | <b>34</b> | <b>29.5</b> | <b>26</b> |
|------------------|---------------|-------------|-------------|-----------|-------------|-----------|

2 SEATER COUCH

|                  |               |             |             |           |             |           |
|------------------|---------------|-------------|-------------|-----------|-------------|-----------|
| <b>COU-2SEAT</b> | <b>\$1541</b> | <b>95.3</b> | <b>21.2</b> | <b>55</b> | <b>29.5</b> | <b>26</b> |
|------------------|---------------|-------------|-------------|-----------|-------------|-----------|

3 SEATER COUCH

|                  |               |            |             |           |             |           |
|------------------|---------------|------------|-------------|-----------|-------------|-----------|
| <b>COU-3SEAT</b> | <b>\$2096</b> | <b>108</b> | <b>39.2</b> | <b>75</b> | <b>29.5</b> | <b>26</b> |
|------------------|---------------|------------|-------------|-----------|-------------|-----------|

- EASY CLEAN BLACK POLYURETHANE SEAT
- SOLID WOOD FRAME CONSTRUCTION & PLUSH CUSHION WITH HIGH-DENSITY FOAM FOR COMFORT
- STURDY STEEL LEG WITH CONTEMPORARY TAPERED DESIGN IN A BLACK POWDER-COAT FINISH
- MANUFACTURED TO EXCEED 100,000 DOUBLE RUBS & MEET OR EXCEED ANSI/BIFMA REQUIREMENTS
- THE 1-SEATER HAS A RECOMMENDED MAX WEIGHT CAPACITY OF 300 LBS
- THE 2-SEATER & 3-SEATER HAVE A RECOMMENDED MAX WEIGHT CAPACITY OF 500 LBS & 750LBS
- 5-YEAR WARRANTY

**AVAILABLE SEAT FINISH:**

BLACK POLYURETHANE (BL)

**AVAILABLE LEG FINISH:**

BLACK POWDER-COAT STEEL LEG (BL)

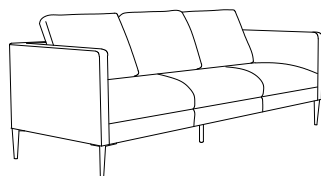
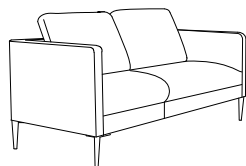
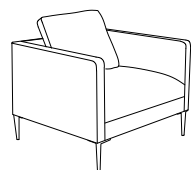

SOFT SEATING

**NEW!** **ATTICUS SOFT SEATING**

1 SEATER COUCH/CHAIR

|                    |              |             |             |             |             |           |
|--------------------|--------------|-------------|-------------|-------------|-------------|-----------|
| <b>COU-B-1SEAT</b> | <b>\$885</b> | <b>52.9</b> | <b>10.9</b> | <b>30.5</b> | <b>29.5</b> | <b>28</b> |
|--------------------|--------------|-------------|-------------|-------------|-------------|-----------|

2 SEATER COUCH

|                    |               |             |             |           |             |           |
|--------------------|---------------|-------------|-------------|-----------|-------------|-----------|
| <b>COU-B-2SEAT</b> | <b>\$1195</b> | <b>95.3</b> | <b>18.4</b> | <b>50</b> | <b>29.5</b> | <b>28</b> |
|--------------------|---------------|-------------|-------------|-----------|-------------|-----------|

3 SEATER COUCH

|                    |               |            |             |           |             |           |
|--------------------|---------------|------------|-------------|-----------|-------------|-----------|
| <b>COU-B-3SEAT</b> | <b>\$1625</b> | <b>108</b> | <b>25.1</b> | <b>69</b> | <b>29.5</b> | <b>28</b> |
|--------------------|---------------|------------|-------------|-----------|-------------|-----------|

- EASY CLEAN BLACK POLYURETHANE SEATS
- SOLID WOOD FRAME CONSTRUCTION & PLUSH CUSHION WITH HIGH-DENSITY FOAM FOR COMFORT
- STURDY ANGLED STEEL LEGS AVAILABLE IN BLACK (BL) OR CHROME (CR)
- MANUFACTURED TO EXCEED 100,000 DOUBLE RUBS & MEET OR EXCEED ANSI/BIFMA REQUIREMENTS
- THE 1-SEATER HAS A RECOMMENDED MAX WEIGHT CAPACITY OF 300 LBS
- THE 2-SEATER & 3-SEATER HAVE A RECOMMENDED MAX WEIGHT CAPACITY OF 500 LBS & 750LBS
- 3-YEAR WARRANTY

**AVAILABLE SEAT FINISH:**

BLACK POLYURETHANE (BL)

**AVAILABLE LEG FINISHES:**

BLACK (BL) & CHROME (CR)

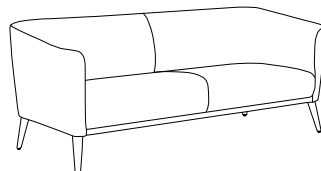
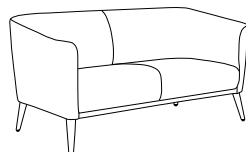
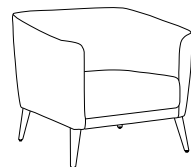

SOFT SEATING

# HEIGHT ADJUSTABLE SERIES

This is a metric series (imperial sizing available). Please refer to page [INDEX-1](#) for details

|   |                           |
|---|---------------------------|
| <b>At a Glance Comparison Chart</b> .....                     | <a href="#">HT-ADJ-2</a>  |
| <b>Finishes</b> .....   | <a href="#">HT-ADJ-3</a>  |
| <b>CALYPSO</b>  |                           |
| <b>Series Specifications &amp; Description (CAL-E1)</b> ..... | <a href="#">HT-ADJ-4</a>  |
| Height Adjustable Bases .....                                 | <a href="#">HT-ADJ-5</a>  |
| <b>ATHENA</b>   |                           |
| <b>Series Specifications &amp; Description (ATH-E1)</b> ..... | <a href="#">HT-ADJ-6</a>  |
| Height Adjustable Bases .....                                 | <a href="#">HT-ADJ-7</a>  |
| <b>ATLAS</b>  |                           |
| <b>Series Specifications &amp; Description (ATL-E1)</b> ..... | <a href="#">HT-ADJ-8</a>  |
| Single Leg Height Adjustable Bases .....                      | <a href="#">HT-ADJ-9</a>  |
| <b>Manual Height Adjustable Base</b>                          |                           |
| 2 Leg Base (900-CRANK) .....                                  | <a href="#">HT-ADJ-9</a>  |
| <b>Height Adjustable Laminate Tops</b>                        |                           |
| <b>Specifications</b> .....                                   | <a href="#">HT-ADJ-10</a> |
| Rectangle .....   | <a href="#">HT-ADJ-10</a> |
| Corner Module & Extended Corner Module .....                  | <a href="#">HT-ADJ-11</a> |
| Return .....  | <a href="#">HT-ADJ-12</a> |
| One Piece L-shape .....                                       | <a href="#">HT-ADJ-13</a> |
| <b>Height Adjustable Shrouds</b> .....                        |                           |
| 2-leg .....   | <a href="#">HT-ADJ-16</a> |
| 3-leg .....   | <a href="#">HT-ADJ-17</a> |
| Modern Reception .....  | <a href="#">HT-ADJ-19</a> |
| <b>Height Adjustable Accessories</b> .....                    |                           |
| Desktop Panels .....  | <a href="#">HT-ADJ-14</a> |
| Modesty Panels .....  | <a href="#">HT-ADJ-15</a> |
| Desk Accessories .....  | <a href="#">HT-ADJ-20</a> |
| <b>Layouts</b> .....  | <a href="#">HT-ADJ-25</a> |

## ELECTRIC HEIGHT ADJUSTABLE AT A GLANCE COMPARISON CHART

| <b>CALYPSO</b><br>HEIGHT ADJUSTABLE BASES   | <b>ATHENA</b><br>HEIGHT ADJUSTABLE BASES  | <b>ATLAS</b><br>SINGLE LEG HEIGHT ADJUSTABLE BASE   |
|---|---|---|
| <ul style="list-style-type: none"> <li><b>Height Range:</b> 22" - 48" (not including 1" top)</li> <li><b>Available Finish:</b> Silver (SL), Black (BL) or White (WH)</li> <li>Heavy Duty 3-stage steel frame design</li> <li>Actuator system with synchronized motor driving each leg</li> <li>Anti-collision function</li> <li>CSA/UL Certified</li> <li>BIFMA Certified</li> <li>Quick Assembly (easy fold out leg/frame)</li> <li>4 programmable memory positions</li> <li>Operated at 1.3" per second</li> <li>Whisper quiet &lt;50dB</li> <li>Max weight capacity: 2 leg base - 265 lbs<br/>3 leg base - 320 lbs</li> <li>Includes 10mm adjustable glides</li> <li>Limited lifetime warranty on laminates; 15 year warranty on structural components; 7 year warranty on mechanical components</li> <li>Compatible with modesty or desktop panels</li> </ul> | <ul style="list-style-type: none"> <li><b>Height Range:</b> 27.5" - 45.5" (not including 1" top)</li> <li><b>Available Finish:</b> Silver (SL) or Black (BL)</li> <li>Sturdy, 2-stage steel frame design</li> <li>Actuator system with dual synchronized motor driving each leg</li> <li>Anti-collision function</li> <li>CSA/UL Certified</li> <li>BIFMA Certified (2 LEG ANSI/BIFMA x 5.5-2014)</li> <li>Quick assembly design</li> <li>4 programmable memory positions</li> <li>Operated at 1" per second</li> <li>Whisper quiet &lt;50dB</li> <li>Max weight capacity: 2 leg base - 220 lbs<br/>3 leg base - 330 lbs</li> <li>Includes adjustable glides</li> <li>Limited lifetime warranty on laminates; 2 year warranty on electric and 5 years warranty on steel components</li> <li>Compatible with modesty or desktop panels</li> <li>Low power consumption in standby mode</li> </ul> | <ul style="list-style-type: none"> <li><b>Height Range:</b> 23.5" - 49" (not including 1" top)</li> <li><b>Available Finish:</b> Silver (SL)</li> <li>Sturdy, 3-stage steel frame design</li> <li>Actuator system with a heavy-duty motor driving the single leg</li> <li>Adjustable anti-collision function</li> <li>CSA/UL Certified</li> <li>Quick assembly design</li> <li>4 programmable memory positions</li> <li>Operated at 1" per second</li> <li>Quiet &lt;55dB</li> <li>Max weight capacity: 1 leg base - 130 lbs</li> <li>Includes adjustable glides</li> <li>Limited lifetime warranty on laminates; 2 year warranty on electric and 2 years warranty on steel components</li> <li>Compatible with modesty or desktop panels</li> <li>Low power consumption in standby mode</li> </ul> |

| SIZING   | SIZING   | SIZING                         |
|--|--|--------------------------------|
|  |  |                                |
| PRICING  | PRICING  | PRICING                        |
| 2 LEG MODEL: \$1,364 (BASE ONLY)<br>3 LEG MODEL: \$1,988 (BASE ONLY) | 2 LEG MODEL: \$1060 (BASE ONLY)<br>3 LEG MODEL: \$1527 (BASE ONLY) | 1 LEG MODEL: \$817 (BASE ONLY) |

## Finishes

### Laminate Finishes

(Applicable finishes for Height Adjustable laminate tops. Height Adjustable tops can be used with Calypso, Athena and Atlas bases.) See sizing for top compatibility.

| ABBR | LAMINATE COLOUR    | TOPS  | MATCHING EDGE | GROMMET (BLACK) |
|------|--------------------|-------|---------------|-----------------|
| AM   | Autumn Maple       | ✓     | ✓             | ✓               |
| BL   | Black              | ✓     | ✓             | ✓               |
| BW   | Black Walnut       | ✓     | ✓             | ✓               |
| CD   | Cappuccino Dream** | ✓     | ✓             | ✓               |
| CM   | Charcoal Matrix    | ✓     | Black         | ✓               |
| DE   | Desert Sand        | ✓     | ✓             | ✓               |
| DD   | Driftwood***       | ✓     | ✓             | ✓               |
| DW   | Driftwood Grey**   | (n/a) | (n/a)         | (n/a)           |
| EZ   | Evening Zen        | ✓     | ✓             | ✓               |
| GA   | Golden Ash         | ✓     | ✓             | ✓               |
| GD   | Grey Dusk          | ✓     | ✓             | ✓               |
| GM   | Grey Matrix        | ✓     | Grey          | ✓               |
| GR   | Grey               | ✓     | ✓             | ✓               |
| GT   | Graphite           | ✓     | ✓             | ✓               |
| HM   | Hardrock Maple     | ✓     | ✓             | ✓               |
| NC   | Noce Cocoa         | ✓     | ✓             | Grey            |
| PW   | Pure White         | ✓     | ✓             | Grey            |
| RM   | Royal Mahogany     | ✓     | ✓             | ✓               |
| SM   | Sugar Maple        | ✓     | ✓             | ✓               |
| SW   | Seaside White      | ✓     | ✓             | Grey            |
| VA   | Volcanic Ash       | ✓     | ✓             | ✓               |
| WW   | Winter Wood        | ✓     | ✓             | Grey            |

\*\* TEXTURED FINISH

\*\*\* NON-TEXTURED FINISH - 1" & 1½" ONLY

For custom high pressure options contact Customer Service.

| ABBR | BASE COLOUR | CALYPSO | ATHENA | ATLAS |
|------|-------------|---------|--------|-------|
| BL   | Black       | ✓       | ✓      | ✓     |
| SL   | Silver      | ✓       | ✓      | X     |
| WH   | White       | ✓       | X      | X     |

**NOTE:** Information is current at time of print. For up to date information check online at [www.heartwood.ca](http://www.heartwood.ca).

**CAL-E1 - BASE SPECIFICATIONS (ELECTRIC HEIGHT ADJUSTABLE)**

- ♥ Quick assembly (easy fold leg design)
- ♥ Maximum footprint 94.5" - 94.5" (metric top 96 x 96)
- ♥ Extended height range 22" - 48" not including top
- ♥ Heavy Duty 3-stage steel frame design
- ♥ Operated at 1.3" per second
- ♥ Actuator system with synchronized motor driving each leg
- ♥ Anti-collision function automatically stops motors when table hits immovable object
- ♥ Lift capacity (265lbs for 2 leg base); (320lbs for 3 leg base)
- ♥ Keypad has 4 programable positions
- ♥ Control panel can be moved once mounted
- ♥ Includes adjustable glides
- ♥ BIFMA certified (2 leg model)
- ♥ CSA/UL Certified
- ♥ Whisper quiet <50dB
- ♥ Three available finishes: Black (BL), Silver (SL) and White (WH)

**Sizing Details**

- ♥ 2 leg desk (CAL-E1-2LEG)
  - Extended height range 22" - 48" not including top
  - Width adjustment: MIN/MAX 47.25" to 94.5" wide top
  - 23.75" - 35.5" deep top
  - 26.75" foot depth
  - Legs offset - 15" accessory clearance depth on a 29.5" top

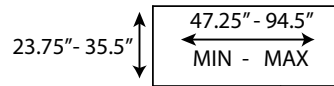

- ♥ 3 leg desk (CAL-E1-3LEG)
  - Extended height range 22" - 48" not including top
  - Width adjustment: MIN is 47.25" X 59.5" combined top size  
MAX is 94.5" X 94.5" combined top size
  - 23.75" - 35.5" deep top
  - 26.75" foot depth
  - 15.75" return foot depth
  - Corner planter foot

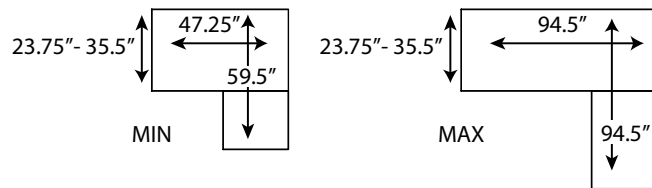

See page [HT-ADJ-15](#) for compatible Modesty Panels & Accessories

**Warranty**

- ♥ Limited lifetime warranty on laminates; 15 year warranty on structural components; 7 year warranty on mechanical components

**Shipping CAL-E1 Series**

- ♥ Ships Ready-to-Assemble (RTA)

EXAMPLE

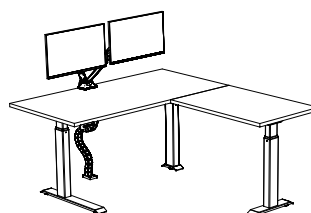

HEIGHT ADJUSTABLE BASES & TOPS ARE COMPATIBLE WITH MONITOR ARMS & WIRE MANAGEMENT. SEE ACCESSORIES PAGE [HT-ADJ-20](#)

| MODEL | LIST | WEIGHT | CUBE            | W  | D  | H  |
|-------|------|--------|-----------------|----|----|----|
|       |      | LBS    | FT <sup>3</sup> | IN | IN | IN |

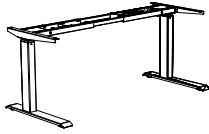

**STRAIGHT ELECTRIC HEIGHT ADJUSTABLE 2 LEG BASE**

|                    |                |           |            |   |  |  |
|--------------------|----------------|-----------|------------|---|--|--|
| <b>CAL-E1-2LEG</b> | <b>\$1,364</b> | <b>88</b> | <b>3.5</b> | <b>SEE SIZING DETAILS PAGE <a href="#">HT-ADJ-4</a></b> |  |  |
|--------------------|----------------|-----------|------------|---|--|--|

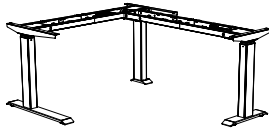

**L SHAPED ELECTRIC HEIGHT ADJUSTABLE 3 LEG BASE**

|                    |                |              |            |   |  |  |
|--------------------|----------------|--------------|------------|---|--|--|
| <b>CAL-E1-3LEG</b> | <b>\$1,988</b> | <b>140.8</b> | <b>6.4</b> | <b>SEE SIZING DETAILS PAGE <a href="#">HT-ADJ-4</a></b> |  |  |
|--------------------|----------------|--------------|------------|---|--|--|

**AVAILABLE FINISH:** BLACK (BL), SILVER (SL) OR WHITE

- PLANTER FOOT IS INCLUDED BUT INSTALLATION IS OPTIONAL. FOR MAXIMUM STABILITY INSTALL THE FULL LENGTH FOOT.



**OPTIONAL CORNER MODULE FOOT**

|                        |              |             |            |  |  |  |
|------------------------|--------------|-------------|------------|--|--|--|
| <b>CAL-E1-2LEG-CMF</b> | <b>\$212</b> | <b>9.92</b> | <b>.31</b> |  |  |  |
|------------------------|--------------|-------------|------------|--|--|--|

**AVAILABLE FINISH:** BLACK (BL) OR SILVER (SL)

- FOR USE WITH 36" OR 42" SIDE ON EXTENDED CORNER UNITS. FOR 48" SIDE ON EXTENDED CORNER UNITS, PLEASE USE 3-LEG BASE (CAL-E1-3LEG)

**EXAMPLE ORDER:** CAL-E1-2LEG + CAL-E1-2LEG-CMF  
**\$1,364 + \$212 = \$1576**

CAL-CM2436-7224 WITH CAL-E1-2LEG & CAL-E1-2LEG-CMF

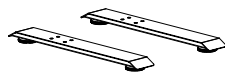
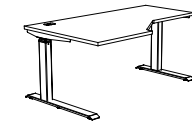

**OPTIONAL 23" FOOT**

|                        |             |             |             |             |           |          |
|------------------------|-------------|-------------|-------------|-------------|-----------|----------|
| <b>CAL-E1-2LEG-23F</b> | <b>\$54</b> | <b>12.1</b> | <b>0.11</b> | <b>3.25</b> | <b>23</b> | <b>1</b> |
|------------------------|-------------|-------------|-------------|-------------|-----------|----------|

**AVAILABLE FINISH:** BLACK (BL), SILVER (SL) OR WHITE

- STANDARD HEIGHT ADJUSTABLE BASE FEET SIT PROUD UNDER A 24" DEEP TOP. USE OPTIONAL 23" DEPTH FEET IF FLUSH INSTALL IS REQUIRED.
- 2 FEET PER CARTON

**EXAMPLE ORDER:** CAL-E1-2LEG + CAL-E1-2LEG-23F  
**\$1,364 + \$54 = \$1418**

CAL-CM2436-7224 WITH CAL-E1-2LEG & CAL-E1-2LEG-23F

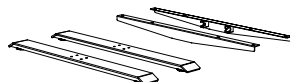
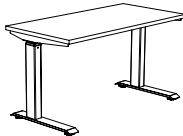

**OPTIONAL 34" CENTERED TOP PLATE & FOOT KIT**

|                         |              |             |             |  |  |  |
|-------------------------|--------------|-------------|-------------|--|--|--|
| <b>CAL-E1-2LEG-34TF</b> | <b>\$160</b> | <b>23.1</b> | <b>0.32</b> |  |  |  |
|-------------------------|--------------|-------------|-------------|--|--|--|

- FOR USE WHEN ORDERING 36" DEEP TOPS.
- TOP PLATES AND FEET CONVERT A STANDARD 2LEG OFFSET CALYPSO INTO A 2 LEG CENTERED CALYPSO

**EXAMPLE ORDER:** CAL-E1-2LEG + CAL-E1-2LEG-34TF  
**\$1,364 + \$160 = \$1524**

**AVAILABLE FINISH:** SILVER (SL)

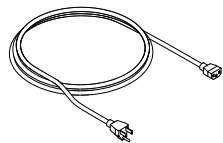

**OPTIONAL 12' POWER CORD**

- 12' POWER CORD FOR CALYPSO BASE

|                         |             |            |             |  |  |  |
|-------------------------|-------------|------------|-------------|--|--|--|
| <b>CAL-E1-PWR-12-BL</b> | <b>\$26</b> | <b>0.8</b> | <b>0.05</b> |  |  |  |
|-------------------------|-------------|------------|-------------|--|--|--|

**AVAILABLE FINISH:** BLACK (BL)

**OPTIONAL 30MM LEVELLERS**

- 30MM THREAD LENGTH VS DEFAULT 10MM LENGTH

|                    |             |  |  |  |  |  |
|--------------------|-------------|--|--|--|--|--|
| <b>CAL-E1-ELEV</b> | <b>\$40</b> |  |  |  |  |  |
|--------------------|-------------|--|--|--|--|--|

**AVAILABLE FINISH:** BLACK (BL)

## ATH-E1 - BASE SPECIFICATIONS (ELECTRIC HEIGHT ADJUSTABLE)

### Construction

- ♥ Quick assembly design
- ♥ Sturdy, 2-stage, steel frame construction
- ♥ ANSI/BIFMA Certified (2 leg model x 5.5-2014)
- ♥ Operated at 1" per second
- ♥ Whisper quiet <50dB
- ♥ 4 programmable memory positions
- ♥ Actuator system with synchronized motor driving each leg
- ♥ Includes adjustable glides
- ♥ Low power consumption in standby mode
- ♥ Fits 24" & 30" tops, centered legs for more support
- ♥ Easy to stock, 2 leg model converts to 3 leg model with addition of leg unit

### Sizing Details

- ♥ 2 leg desk (ATH-E1-2LEG)
  - Extended height range 27.5" - 45.5" not including 1" top
  - Width adjustment: MIN/MAX 43" - 76.75" wide top
  - 23.75" - 29.5" deep top
  - 23" foot depth
  - Legs centered - 9" accessory clearance depth on a 29.5" top
- ♥ ATH-E1-2LEG - Max weight capacity of base only (excludes top) is 220 lbs (100kg)

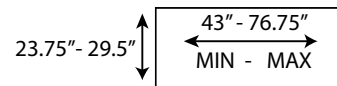

- ♥ 3 leg desk (ATH-E1-3LEG)
  - Extended height range 27.5" - 45.5" not including 1" top
  - Width adjustment: MIN is 43" X 57" combined top size
  - MAX is 76.75" X 88.5" combined top size
  - 23.75" - 29.5" deep top
  - 23" foot depth
  - 15.75" return foot depth
  - Legs centered - 9" accessory clearance depth on a 29.5" top
  - Corner planter foot (included in carton but install is optional)
- ♥ ATH-E1-3LEG - Max weight capacity of base only (excludes top) is 330 lbs (150kg)

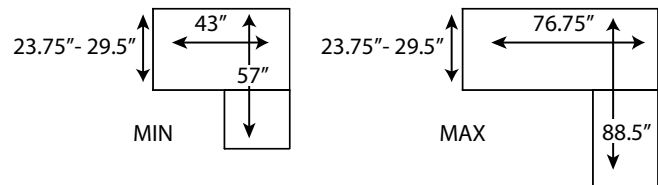

### Warranty

- ♥ 2 years electrical, 5 years moving components.
- ♥ Limited lifetime warranty for laminate worksurfaces.

### Shipping ATH-E1 Series

- ♥ Ships Ready-to-Assemble (RTA)

See page [HT-ADJ-15](#) for compatible Modesty Panels & Accessories



| MODEL | LIST | WEIGHT | CUBE            | W  | D  | H  |
|-------|------|--------|-----------------|----|----|----|
|       |      | LBS    | FT <sup>3</sup> | IN | IN | IN |

**STRAIGHT ELECTRIC HEIGHT ADJUSTABLE 2 LEG BASE**

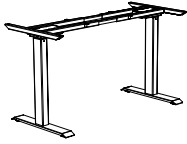

|                    |               |             |             |                           |                 |                 |
|--------------------|---------------|-------------|-------------|---------------------------|-----------------|-----------------|
| <b>ATH-E1-2LEG</b> | <b>\$1060</b> | <b>73.9</b> | <b>2.78</b> | <b>SEE SIZING DETAILS</b> | <b>SEE PAGE</b> | <b>HT-ADJ-6</b> |
|--------------------|---------------|-------------|-------------|---------------------------|-----------------|-----------------|

- AVAILABLE FINISH:** BLACK (BL) OR SILVER (SL)
- STURDY 2 STAGE STEEL FRAME CONSTRUCTION
  - QUICK ASSEMBLY HEIGHT ADJUSTABLE BASE
  - 4 PROGRAMABLE MEMORY POSITIONS.
  - ANSI/BIFMA CERTIFIED X5.5-2014

**L SHAPED ELECTRIC HEIGHT ADJUSTABLE 3 LEG BASE**

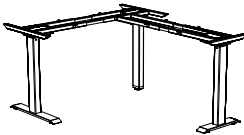

|                    |               |              |             |                           |                 |                 |
|--------------------|---------------|--------------|-------------|---------------------------|-----------------|-----------------|
| <b>ATH-E1-3LEG</b> | <b>\$1527</b> | <b>120.2</b> | <b>5.55</b> | <b>SEE SIZING DETAILS</b> | <b>SEE PAGE</b> | <b>HT-ADJ-6</b> |
|--------------------|---------------|--------------|-------------|---------------------------|-----------------|-----------------|

- AVAILABLE FINISH:** BLACK (BL) OR SILVER (SL)
- STURDY 2 STAGE STEEL FRAME CONSTRUCTION
  - QUICK ASSEMBLY HEIGHT ADJUSTABLE BASE
  - 4 PROGRAMABLE MEMORY POSITIONS.

ATHENA 2 LEG & 3 LEG BASES ARE COMPATIBLE WITH CALYPSO TOPS. SEE PAGE [HT-ADJ-10](#) FOR TOPS. IN-STOCK TOP OPTIONS CAN BE FOUND IN OUR HDL PRICE BOOK OR AT [WWW.HEARTWOOD-DL.COM](http://WWW.HEARTWOOD-DL.COM).

EXAMPLES

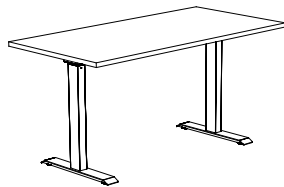

CAL-REC3060  
 + ATH-E1-2LEG

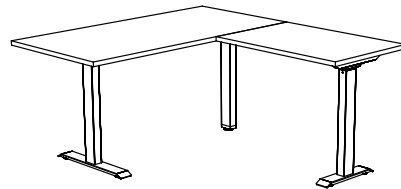

CAL-REC3066  
 CAL-RS2436  
 + ATH-E1-3LEG

## ATL-E1 - Single Leg Base Specifications (Electric Height Adjustable)

### Features & Construction

- ♥ Quick assembly single leg design
- ♥ Suitable for sit to stand solutions for smaller top sizes (24"-42" wide rectangle tops or corner module tops)
- ♥ Great to convert existing fixed height L-shape or U-shape suites to height adjustable (re-use existing bridge or return shell tops and mount onto ATLAS base)
- ♥ The perfect option for tight spaces
- ♥ Sturdy, 3-stage, steel frame construction
- ♥ Operated at 1" per second
- ♥ Quiet operation <55dB
- ♥ 4 programmable memory positions
- ♥ Actuator system with a heavy-duty motor driving the single leg
- ♥ Includes adjustable glides - 10mm adjustable
- ♥ Adjustable Anti-collision feature
- ♥ CSA/UL certified
- ♥ Low power consumption in standby mode
- ♥ Lifting capacity: 130lbs

### Sizing Details

#### ♥ ATL-E1-1LEG

Extended height range 24.5" - 50" (including 1" top)

Width adjustment: Corner Module

MIN/MAX 35.5/ 35.5" - 41.5"/41.5" top

Width adjustment: Rectangle

MIN/MAX 23.75" - 41.5" top

Foot depth: 21.75"

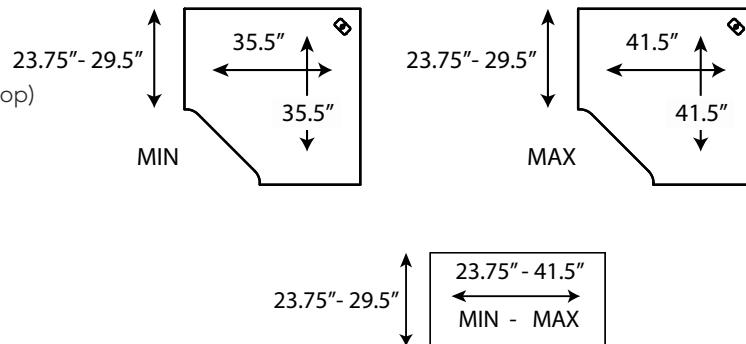

### Warranty

- ♥ 2 years electrical, 2 years moving components.
- ♥ Limited lifetime warranty for laminate worksurfaces.

### Shipping ALT-E1 Series

- ♥ Ships Ready-to-Assemble (RTA)

See page [HT-ADJ-15](#) for compatible Modesty Panels & Accessories

| MODEL | LIST | WEIGHT | CUBE            | W  | D  | H  |
|-------|------|--------|-----------------|----|----|----|
|       |      | LBS    | FT <sup>3</sup> | IN | IN | IN |

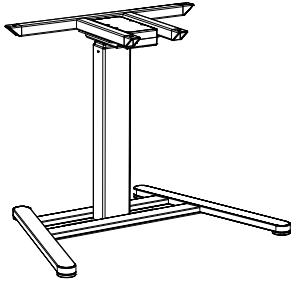

**SINGLE LEG ELECTRIC HEIGHT ADJUSTABLE BASE**

COMPATIBLE WITH CALYPSO HEIGHT ADJUSTABLE TOPS. SEE SIZING FOR COMPATIBILITY OPTIONS.

|                    |              |             |             |   |
|--------------------|--------------|-------------|-------------|---|
| <b>ATL-E1-1LEG</b> | <b>\$817</b> | <b>48.5</b> | <b>2.73</b> | <b>SEE SIZING DETAILS PAGE HT-ADJ-4</b> |
|--------------------|--------------|-------------|-------------|---|

- 3-STAGE, STEEL FRAME CONSTRUCTION. ACTUATOR SYSTEM WITH A HEAVY DUTY MOTOR DRIVING THE SINGLE LEG.
- QUICK ASSEMBLY HEIGHT ADJUSTABLE BASE
- 4 PROGRAMMABLE MEMORY POSITIONS. LOW POWER CONSUMPTION IN STANDBY MODE.
- LIFT CAPACITY: 130LBS

**AVAILABLE FINISHES:** SILVER (SL)

**EXAMPLES**

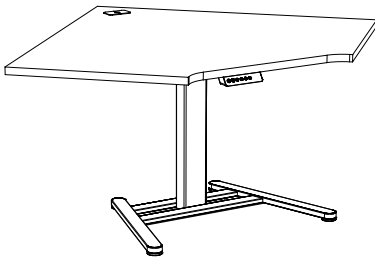

ATL-E1-1LEG & CAL-CM2442

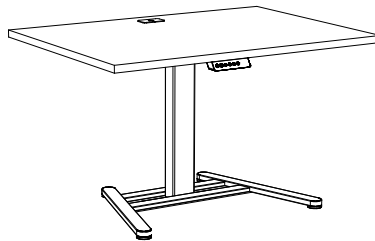

ATL-E1-1LEG & CAL-REC2442

**MANUAL HEIGHT-ADJUSTABLE**

**MANUAL HEIGHT ADJUSTABLE BASE**

COMPATIBLE WITH CALYPSO TOPS. SEE SIZING FOR COMPATIBILITY OPTIONS.

|                  |              |              |            |                           |
|------------------|--------------|--------------|------------|---------------------------|
| <b>900-CRANK</b> | <b>\$830</b> | <b>44.54</b> | <b>1.6</b> | <b>SEE SIZING DETAILS</b> |
|------------------|--------------|--------------|------------|---------------------------|

- COMPACT MANUAL SIT-TO-STAND DESK FRAME (BASE ONLY)
- FOLDABLE HANDLE PREVENTS INTERFERENCE
- ADJUSTABLE LEVELERS ADAPTABLE TO MOST ANY FLOOR SURFACE

**AVAILABLE FINISH** SILVER

**SIZING DETAILS**

- TOP SIZE RANGE: 35" MIN - 60" MAX WIDTH (LARGER THAN 60" WIDE IS NOT RECOMMENDED)
- HEIGHT RANGE: 28.75" MIN - 48.5" MAX (NO TOP)

**WEIGHT ALLOWANCE**

- WEIGHT CAPACITY: 154 LBS (EXCLUDING TOP)

**WARRANTY**

- 2 YEARS MOVING COMPONENTS.
- LIMITED LIFETIME WARRANTY FOR LAMINATE WORKSURFACES (SOLD SEPARATELY)

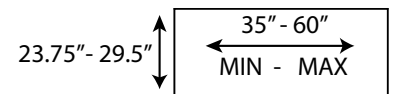
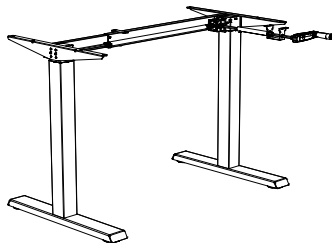

# HEIGHT ADJUSTABLE TOPS

## RECTANGLE TOPS

| MODEL | LIST | WEIGHT | CUBE            | W  | D  | H  |
|-------|------|--------|-----------------|----|----|----|
|       |      | LBS    | FT <sup>3</sup> | IN | IN | IN |

### Top Specifications

- ♥ 1" thick laminate tops available (special quote pricing required for 1½" thick tops)
- ♥ Height adjustable tops work with Heartwood height adjustable bases and 3rd party height adjustable bases.
- ♥ Consult individual **base sizing details** when choosing your top configurations.
- ♥ Standard 5-sided corner modules work with **ATLAS** Heartwood bases **ONLY**
- ♥ Corner module, extended corner module and rectangle tops include a grommet, return shell tops do not.  
For custom grommets, please contact customer service
- ♥ Custom sizes available, contact customer service for pricing. For simple width changes, use the next price rule.
- ♥ **Ordering Example:** For CAL-REC-2462 use CAL-REC2466
- ♥ Edges:
  - Edges all finished in 2mm matching edge band
  - Banding changes to an alternate Heartwood standard colour are available at no extra charge.
- ♥ Built in Canada

#### 24" RECTANGLE TOP 24" DEEP TOP INCLUDES CENTER GROMMET

|             |       |       |      |       |       |   |
|-------------|-------|-------|------|-------|-------|---|
| CAL-REC2424 | \$244 | 21.8  | 0.75 | 23.75 | 23.75 | 1 |
| CAL-REC2430 | \$248 | 27.25 | 0.86 | 29.75 | 23.75 | 1 |
| CAL-REC2436 | \$248 | 32.7  | 1.09 | 35.5  | 23.75 | 1 |
| CAL-REC2442 | \$271 | 43.6  | 1.26 | 41.5  | 23.75 | 1 |
| CAL-REC2448 | \$290 | 29.1  | 1.4  | 47.25 | 23.75 | 1 |
| CAL-REC2454 | \$363 | 32.7  | 1.6  | 53.25 | 23.75 | 1 |
| CAL-REC2460 | \$387 | 36.3  | 1.8  | 59.25 | 23.75 | 1 |
| CAL-REC2466 | \$398 | 39.9  | 1.9  | 65    | 23.75 | 1 |
| CAL-REC2472 | \$414 | 43.6  | 2.1  | 71    | 23.75 | 1 |
| CAL-REC2478 | \$426 | 47.2  | 2.3  | 77    | 23.75 | 1 |
| CAL-REC2484 | \$461 | 50.9  | 2.5  | 82.75 | 23.75 | 1 |
| CAL-REC2496 | \$497 | 58.1  | 2.81 | 94.5  | 23.75 | 1 |

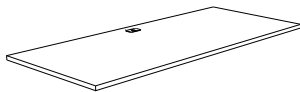

CAL-REC2472

#### 30" RECTANGLE TOP 30" DEEP TOP INCLUDES CENTER GROMMET

|             |       |       |      |       |      |   |
|-------------|-------|-------|------|-------|------|---|
| CAL-REC3024 | \$282 | 27.25 | 0.92 | 23.75 | 29.5 | 1 |
| CAL-REC3030 | \$299 | 34.06 | 1.13 | 29.75 | 29.5 | 1 |
| CAL-REC3036 | \$299 | 40.87 | 1.34 | 35.5  | 29.5 | 1 |
| CAL-REC3042 | \$302 | 47.68 | 1.55 | 41.5  | 29.5 | 1 |
| CAL-REC3048 | \$312 | 36.3  | 1.8  | 47.25 | 29.5 | 1 |
| CAL-REC3054 | \$389 | 40.9  | 1.9  | 53.25 | 29.5 | 1 |
| CAL-REC3060 | \$410 | 45.4  | 2.2  | 59.25 | 29.5 | 1 |
| CAL-REC3066 | \$439 | 49.9  | 2.4  | 65    | 29.5 | 1 |
| CAL-REC3072 | \$453 | 54.5  | 2.6  | 71    | 29.5 | 1 |
| CAL-REC3078 | \$610 | 59.1  | 2.8  | 77    | 29.5 | 1 |
| CAL-REC3084 | \$643 | 63.6  | 3.1  | 82.75 | 29.5 | 1 |
| CAL-REC3096 | \$673 | 72.7  | 3.46 | 94.5  | 29.5 | 1 |

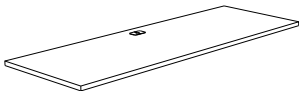

CAL-REC3072

| MODEL | LIST | WEIGHT | CUBE            | W  | D  | H  |
|-------|------|--------|-----------------|----|----|----|
|       |      | LBS    | FT <sup>3</sup> | IN | IN | IN |

FOR RADIUS CORNER MODULE SHAPE, ADD "R" TO SKU  
ORDER EXAMPLE: CAL-RCM-2436-7224

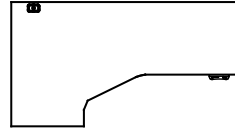

DEFAULT - CM SHAPE

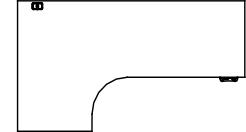

RCM SHAPE

**5-SIDED CORNER MODULE TOP**

INCLUDES GROMMET. DESK TOP ORDERED SEPARATELY.

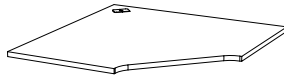

|            |       |       |      |      |      |   |
|------------|-------|-------|------|------|------|---|
| CAL-CM2436 | \$456 | 49    | 1.59 | 35.5 | 35.5 | 1 |
| CAL-CM2442 | \$497 | 66.75 | 2.14 | 41.5 | 41.5 | 1 |
| CAL-CM3042 | \$510 | 66.75 | 2.14 | 41.5 | 41.5 | 1 |

**LEFT EXTENDED CORNER MODULE TOP**

INCLUDES GROMMET. DESK TOP ORDERED SEPARATELY.



CAL-CM2472-3624

|                 |       |      |     |             |            |   |
|-----------------|-------|------|-----|-------------|------------|---|
| CAL-CM2460-3624 | \$590 | 43.6 | 2.6 | 23.75/59.25 | 35.5/23.75 | 1 |
| CAL-CM2466-3624 | \$603 | 47.3 | 2.9 | 23.75/65    | 35.5/23.75 | 1 |
| CAL-CM2466-3630 | \$614 | 49   | 2.9 | 23.75/65    | 35.5/29.5  | 1 |
| CAL-CM2472-3624 | \$625 | 50.9 | 3.1 | 23.75/71    | 35.5/23.75 | 1 |
| CAL-CM2472-3630 | \$637 | 52.7 | 3.1 | 23.75/71    | 35.5/29.5  | 1 |
| CAL-CM2478-3624 | \$672 | 54.5 | 3.4 | 23.75/77    | 35.5/23.75 | 1 |
| CAL-CM2478-3630 | \$683 | 56.3 | 3.4 | 23.75/77    | 35.5/29.5  | 1 |
| CAL-CM2484-3624 | \$730 | 58.1 | 3.6 | 23.75/82.75 | 35.5/23.75 | 1 |
| CAL-CM2484-3630 | \$814 | 60   | 3.6 | 23.75/82.75 | 35.5/29.5  | 1 |

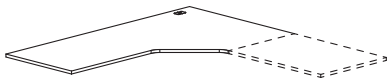

CAL-CM3084-4830

|                 |       |      |     |            |            |   |
|-----------------|-------|------|-----|------------|------------|---|
| CAL-CM3066-4224 | \$650 | 57.2 | 3.3 | 29.5/65    | 41.5/23.75 | 1 |
| CAL-CM3066-4230 | \$693 | 59   | 3.3 | 29.5/65    | 41.5/29.5  | 1 |
| CAL-CM3072-4224 | \$734 | 61.8 | 3.6 | 29.5/71    | 41.5/23.75 | 1 |
| CAL-CM3072-4230 | \$780 | 63.6 | 3.6 | 29.5/71    | 41.5/29.5  | 1 |
| CAL-CM3072-4830 | \$805 | 68.1 | 4.1 | 47.25/71   | 47.25/29.5 | 1 |
| CAL-CM3078-4224 | \$789 | 66.3 | 3.9 | 29.5/77    | 41.5/23.75 | 1 |
| CAL-CM3078-4230 | \$831 | 68.1 | 3.9 | 29.5/77    | 41.5/29.5  | 1 |
| CAL-CM3078-4830 | \$893 | 72.7 | 4.4 | 29.5/77    | 47.25/29.5 | 1 |
| CAL-CM3084-4224 | \$855 | 70.9 | 4.2 | 29.5/82.75 | 41.5/23.75 | 1 |
| CAL-CM3084-4230 | \$899 | 72.7 | 4.2 | 29.5/82.75 | 41.5/29.5  | 1 |
| CAL-CM3084-4830 | \$915 | 77.2 | 4.7 | 29.5/82.75 | 47.25/29.5 | 1 |

| MODEL | LIST | WEIGHT | CUBE            | W  | D  | H  |
|-------|------|--------|-----------------|----|----|----|
|       |      | LBS    | FT <sup>3</sup> | IN | IN | IN |

**RIGHT EXTENDED CORNER MODULE TOP**  
INCLUDES GROMMET. DESK TOP ORDERED SEPARATELY.



CAL-CM2436-7224

|                 |       |      |     |            |             |   |
|-----------------|-------|------|-----|------------|-------------|---|
| CAL-CM2436-6024 | \$590 | 43.6 | 2.6 | 23.75/35.5 | 59.25/23.75 | 1 |
| CAL-CM2436-6624 | \$603 | 47.3 | 2.9 | 23.75/35.5 | 65/23.75    | 1 |
| CAL-CM3036-6624 | \$614 | 49   | 2.9 | 29.5/35.5  | 65/23.75    | 1 |
| CAL-CM2436-7224 | \$625 | 50.9 | 3.1 | 23.75/35.5 | 71/23.75    | 1 |
| CAL-CM3036-7224 | \$637 | 52.7 | 3.1 | 29.5/35.5  | 71/23.75    | 1 |
| CAL-CM2436-7824 | \$672 | 54.5 | 3.4 | 23.75/35.5 | 77/23.75    | 1 |
| CAL-CM3036-7824 | \$683 | 56.3 | 3.4 | 29.5/35.5  | 77/23.75    | 1 |
| CAL-CM2436-8424 | \$730 | 58.1 | 3.6 | 23.75/35.5 | 82.75/23.75 | 1 |
| CAL-CM3036-8424 | \$814 | 60   | 3.6 | 29.5/35.5  | 82.75/23.75 | 1 |

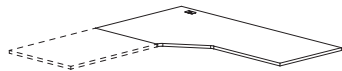

CAL-CM3048-7830

|                 |       |      |     |            |            |   |
|-----------------|-------|------|-----|------------|------------|---|
| CAL-CM2442-6630 | \$650 | 57.2 | 3.3 | 23.75/41.5 | 65/29.5    | 1 |
| CAL-CM3042-6630 | \$693 | 59   | 3.3 | 29.5/41.5  | 65/29.5    | 1 |
| CAL-CM2442-7230 | \$734 | 61.8 | 3.6 | 23.75/41.5 | 71/29.5    | 1 |
| CAL-CM3042-7230 | \$780 | 63.6 | 3.6 | 29.5/41.5  | 71/29.5    | 1 |
| CAL-CM3048-7230 | \$805 | 68.1 | 4.1 | 29.5/47.25 | 71/29.5    | 1 |
| CAL-CM2442-7830 | \$789 | 66.3 | 3.9 | 23.75/41.5 | 77/29.5    | 1 |
| CAL-CM3042-7830 | \$831 | 68.1 | 3.9 | 29.5/41.5  | 77/29.5    | 1 |
| CAL-CM3048-7830 | \$893 | 72.7 | 4.4 | 29.5/47.25 | 77/29.5    | 1 |
| CAL-CM2442-8430 | \$855 | 70.9 | 4.2 | 23.75/41.5 | 82.75/29.5 | 1 |
| CAL-CM3042-8430 | \$899 | 72.7 | 4.2 | 29.5/41.5  | 82.75/29.5 | 1 |
| CAL-CM3048-8430 | \$915 | 77.2 | 4.7 | 29.5/47.25 | 82.75/29.5 | 1 |

**24" RETURN TOP**  
NO GROMMET

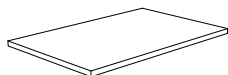

CAL-RS2436

|            |       |      |      |       |       |   |
|------------|-------|------|------|-------|-------|---|
| CAL-RS2424 | \$189 | 14.5 | 0.7  | 23.75 | 23.75 | 1 |
| CAL-RS2430 | \$189 | 18.2 | 0.9  | 29.75 | 23.75 | 1 |
| CAL-RS2436 | \$204 | 21.8 | 1.1  | 35.5  | 23.75 | 1 |
| CAL-RS2442 | \$225 | 25.4 | 1.3  | 41.5  | 23.75 | 1 |
| CAL-RS2448 | \$246 | 29.1 | 1.4  | 47.25 | 23.75 | 1 |
| CAL-RS2454 | \$265 | 32.7 | 1.6  | 53.25 | 23.75 | 1 |
| CAL-RS2460 | \$337 | 36.3 | 1.8  | 59.25 | 23.75 | 1 |
| CAL-RS2466 | \$367 | 40   | 2    | 65    | 23.75 | 1 |
| CAL-RS2472 | \$392 | 43.6 | 2.12 | 71    | 23.75 | 1 |

| MODEL                                | LIST  | WEIGHT | CUBE            | W     | D    | H  |
|--------------------------------------|-------|--------|-----------------|-------|------|----|
|                                      |       | LBS    | FT <sup>3</sup> | IN    | IN   | IN |
| <b>30" RETURN TOP<br/>NO GROMMET</b> |       |        |                 |       |      |    |
| CAL-RS3024                           | \$248 | 18.2   | 0.9             | 23.75 | 29.5 | 1  |
| CAL-RS3030                           | \$251 | 22.7   | 1.1             | 29.5  | 29.5 | 1  |
| CAL-RS3036                           | \$254 | 27.2   | 1.3             | 35.5  | 29.5 | 1  |
| CAL-RS3042                           | \$263 | 31.8   | 1.6             | 41.5  | 29.5 | 1  |
| CAL-RS3048                           | \$285 | 36.3   | 1.8             | 47.25 | 29.5 | 1  |
| CAL-RS3054                           | \$337 | 40.9   | 2               | 53.25 | 29.5 | 1  |
| CAL-RS3060                           | \$384 | 45.4   | 2.2             | 59.25 | 29.5 | 1  |
| CAL-RS3066                           | \$414 | 50     | 2.4             | 65    | 29.5 | 1  |
| CAL-RS3072                           | \$437 | 54.5   | 2.6             | 71    | 29.5 | 1  |

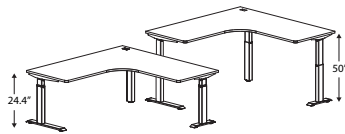

**ONE PIECE L-SHAPE TOPS**  
ONE CORNER MOUNT GROMMET

|                 |         |       |      |              |             |   |
|-----------------|---------|-------|------|--------------|-------------|---|
| CAL-2460-6024LD | \$1,171 | 58    | 4.2  | 23.75/59.25  | 59.25/23.75 | 1 |
| CAL-2460-6030LD | \$1,187 | 63.6  | 4.2  | 23.75//59.25 | 59.25/29.5  | 1 |
| CAL-3060-6024LD | \$1,187 | 63.6  | 4.2  | 29.5/59.25   | 59.25/23.75 | 1 |
| CAL-3060-6030LD | \$1,203 | 68.1  | 4.2  | 29.5/59.25   | 59.25/29.5  | 1 |
| CAL-2466-6624LD | \$1,218 | 65.4  | 5.1  | 23.75/65     | 65/23.75    | 1 |
| CAL-2466-6630LD | \$1,229 | 71.8  | 5.1  | 23.75/65     | 65/29.5     | 1 |
| CAL-3066-6624LD | \$1,229 | 71.8  | 5.1  | 29.5/65      | 65/23.75    | 1 |
| CAL-3066-6630LD | \$1,239 | 77.28 | 5.1  | 29.5/65      | 65/29.5     | 1 |
| CAL-2472-7224LD | \$1,343 | 72.68 | 6.04 | 23.75/71     | 71/23.75    | 1 |
| CAL-2472-7230LD | \$1,364 | 79.98 | 6.04 | 23.75/71     | 71/29.5     | 1 |
| CAL-3072-7224LD | \$1,364 | 79.98 | 6.04 | 29.5/71      | 71/23.75    | 1 |
| CAL-3072-7230LD | \$1,443 | 86.38 | 6.04 | 29.5/71      | 71/29.5     | 1 |

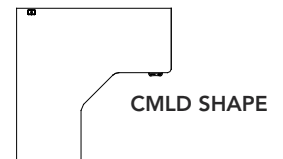
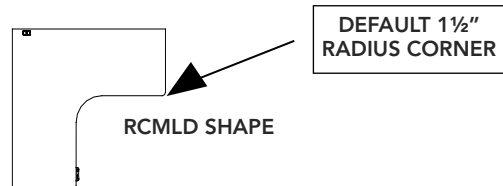
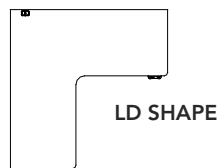

**Calypso is compatible with Accessories, Hanging Modesty Panels & Outlines Partition Panels**

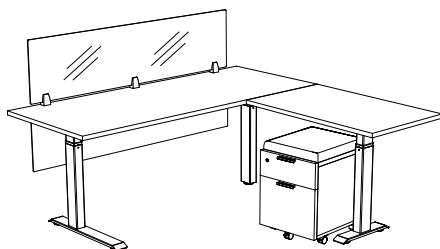

See page [HT-ADJ-15](#) for compatible Laminate Modesty Panels (18" high) or Plexiglass Hanging Modesty panels (16" high)

See page [FLX-16](#) for compatible Flex Modesty Panels (12" high)

See [OUTLINES Series](#) for compatible desktop partition panels

See page [HT-ADJ-20](#) for compatible Accessories

# HEIGHT ADJUSTABLE SERIES DESKTOP PANELS

| MODEL | LIST | WEIGHT | CUBE            | W  | D  | H  |
|-------|------|--------|-----------------|----|----|----|
|       |      | LBS    | FT <sup>3</sup> | IN | IN | IN |

### TEMPERED GLASS PANEL EXTENSION

TOP MOUNT - MOUNT ON FRAMEWORK PANELS, 3RD PARTY PARTITION PANELS OR DESKTOP

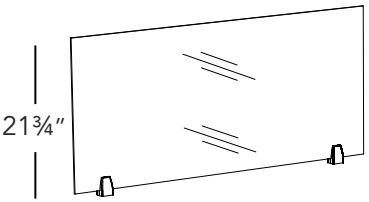

FRM1-2248CLG

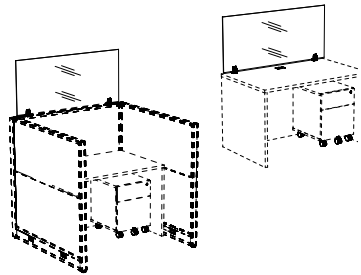

|              |       |      |      |       |      |       |
|--------------|-------|------|------|-------|------|-------|
| FRM1-2224CLG | \$454 | 9.9  | 0.34 | 23.25 | 0.25 | 21.75 |
| FRM1-2230CLG | \$475 | 12.1 | 0.42 | 29.25 | 0.25 | 21.75 |
| FRM1-2236CLG | \$504 | 14.3 | 0.50 | 35    | 0.25 | 21.75 |
| FRM1-2242CLG | \$553 | 16.5 | 0.58 | 41    | 0.25 | 21.75 |
| FRM1-2248CLG | \$600 | 18.7 | 0.66 | 47    | 0.25 | 21.75 |
| FRM1-2260CLG | \$614 | 23.1 | 0.82 | 58.75 | 0.25 | 21.75 |
| FRM1-2266CLG | \$659 | 25.4 | 0.89 | 64.5  | 0.25 | 21.75 |
| FRM1-2272CLG | \$704 | 27.6 | 0.98 | 70.5  | 0.25 | 21.75 |

- 5MM CLEAR TEMPERED GLASS, POLISHED EDGES, "TOUCH" CORNERS ARE STANDARD
- OPTIONAL RADIUS CORNERS ADD -R TO SKU, INCLUDES BOTH UPPER CORNERS. UPCHARGE OF

**BRACKET FINISH:** SILVER (SL) OR BLACK (BL)

### PLEXIGLASS PANEL EXTENSION

CAN BE INSTALLED ON 48" OR 66" HIGH FRAMEWORK MODULAR PANELS, ON THIRD PARTY MODULAR PANEL DESIGNS OR USED IN WORK SURFACE MOUNT APPLICATIONS. INCLUDES ALL MOUNTING HARDWARE.

#### 2 TOP MOUNTING BRACKETS

|              |       |     |      |       |     |      |
|--------------|-------|-----|------|-------|-----|------|
| FRM1-1024PLX | \$213 | 3.2 | 0.1  | 23.25 | .25 | 9.75 |
| FRM1-1030PLX | \$233 | 3.8 | 0.12 | 29.25 | .25 | 9.75 |
| FRM1-1036PLX | \$245 | 4.3 | 0.14 | 35    | .25 | 9.75 |
| FRM1-1042PLX | \$250 | 4.7 | 0.15 | 41    | .25 | 9.75 |
| FRM1-1048PLX | \$264 | 5.3 | 0.17 | 47    | .25 | 9.75 |



FRM1-1030PLX

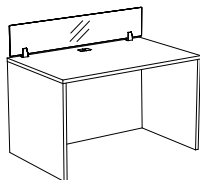

#### 3 TOP MOUNTING BRACKETS

|              |       |     |      |       |      |      |
|--------------|-------|-----|------|-------|------|------|
| FRM1-1054PLX | \$319 | 5.8 | 0.19 | 52.75 | 0.25 | 9.75 |
| FRM1-1060PLX | \$346 | 6.2 | 0.21 | 58.75 | 0.25 | 9.75 |
| FRM1-1066PLX | \$365 | 6.6 | 0.23 | 64.5  | 0.25 | 9.75 |
| FRM1-1072PLX | \$394 | 7.1 | 0.25 | 70.5  | 0.25 | 9.75 |
| FRM1-1078PLX | \$422 | 7.5 | 0.27 | 76.5  | 0.25 | 9.75 |

#### 4 TOP MOUNTING BRACKETS

|              |       |     |      |       |      |      |
|--------------|-------|-----|------|-------|------|------|
| FRM1-1084PLX | \$451 | 8.6 | 0.29 | 82.25 | 0.25 | 9.75 |
| FRM1-1090PLX | \$500 | 9.0 | 0.31 | 88.25 | 0.25 | 9.75 |
| FRM1-1096PLX | \$527 | 9.4 | 0.33 | 94.25 | 0.25 | 9.75 |

- INCLUDES ALL MOUNTING HARDWARE.

**PANEL FINISH:** FROSTED (FR) OR CLEAR (CL) PLEXIGLASS

**BRACKET FINISHES:** SILVER (SL) OR BLACK (BL). DEFAULT FINISH WILL BE SILVER UNLESS OTHERWISE SPECIFIED



| MODEL | LIST | WEIGHT | CUBE            | W  | D  | H  |
|-------|------|--------|-----------------|----|----|----|
|       |      | LBS    | FT <sup>3</sup> | IN | IN | IN |

HEIGHT ADJUSTABLE SERIES IS COMPATIBLE WITH OTHER DESK-TOP MOUNTED PARTITION PANELS.  
SEE [OUTLINES](#) & [OUTLINES Plus SERIES](#)

**16" PLEXIGLASS HANGING MODESTY PANEL**

CAN FIT CALYPSO & ATHENA BASES. ALL MOUNTING HARDWARE INCLUDED. RADIUS CORNER DETAIL.

**2 TOP MOUNT BRACKETS**

|               |       |     |      |       |      |    |
|---------------|-------|-----|------|-------|------|----|
| CAL-MP1636PLX | \$315 | 4.6 | 0.10 | 25.75 | 0.25 | 16 |
| CAL-MP1642PLX | \$346 | 5.3 | 0.12 | 31.5  | 0.25 | 16 |

**3 TOP MOUNT BRACKETS**

|               |       |     |      |       |      |    |
|---------------|-------|-----|------|-------|------|----|
| CAL-MP1648PLX | \$428 | 6.1 | 0.14 | 37.5  | 0.25 | 16 |
| CAL-MP1654PLX | \$454 | 6.8 | 0.17 | 43.5  | 0.25 | 16 |
| CAL-MP1660PLX | \$491 | 7.3 | 0.19 | 49.25 | 0.25 | 16 |

**4 TOP MOUNT BRACKETS**

|               |       |     |      |       |      |    |
|---------------|-------|-----|------|-------|------|----|
| CAL-MP1666PLX | \$511 | 8.2 | 0.21 | 55.25 | 0.25 | 16 |
| CAL-MP1672PLX | \$538 | 8.9 | 0.23 | 61.25 | 0.25 | 16 |
| CAL-MP1678PLX | \$587 | 9.6 | 0.26 | 67    | 0.25 | 16 |

**5 TOP MOUNT BRACKETS**

|               |       |      |      |       |      |    |
|---------------|-------|------|------|-------|------|----|
| CAL-MP1684PLX | \$665 | 10.3 | 0.28 | 73    | 0.25 | 16 |
| CAL-MP1696PLX | \$774 | 11.8 | 0.32 | 84.75 | 0.25 | 16 |

AVAILABLE BRACKET FINISH: BLACK (BL) OR SILVER (SL)

PLEXIGLASS FINISH: BRONZE (BR), CLEAR (CL) & FROSTED (FR)

**18" LAMINATE MODESTY PANELS**

CAN FIT CALYPSO & ATHENA BASES. ALL MOUNTING HARDWARE INCLUDED. SQUARE CORNERS

|               |       |      |     |      |     |    |
|---------------|-------|------|-----|------|-----|----|
| CAL-MP1836LAP | \$223 | 8.8  | .5  | 25.6 | .75 | 18 |
| CAL-MP1842LAP | \$228 | 10.8 | .6  | 31.5 | .75 | 18 |
| CAL-MP1848LAP | \$242 | 12.9 | .7  | 37.4 | .75 | 18 |
| CAL-MP1854LAP | \$254 | 14.9 | .9  | 43.3 | .75 | 18 |
| CAL-MP1860LAP | \$264 | 16.9 | 1.0 | 49.2 | .75 | 18 |
| CAL-MP1866LAP | \$282 | 19.0 | 1.1 | 55.1 | .75 | 18 |
| CAL-MP1872LAP | \$297 | 21.0 | 1.2 | 61   | .75 | 18 |
| CAL-MP1878LAP | \$310 | 23.0 | 1.4 | 66.9 | .75 | 18 |
| CAL-MP1884LAP | \$318 | 25.1 | 1.5 | 72.8 | .75 | 18 |
| CAL-MP1896LAP | \$341 | 29.1 | 1.7 | 84.6 | .75 | 18 |

AVAILABLE FINISH: ALL STANDARD HEARTWOOD LAMINATE COLOURS

- WHEN ORDERING MODESTY PANEL, IT IS RECOMMENDED THAT SKU SIZE SHOULD MATCH DESK OR TOP SKU SIZE  
EX: CAL-CM2472-3624 GETS CAL-MP1872LAP

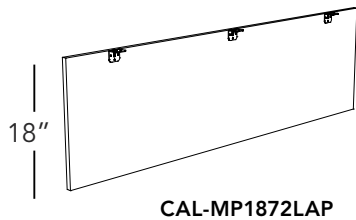
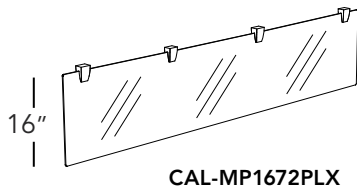

# HEIGHT ADJUSTABLE SERIES

## SHROUD - 2 LEG SHIEGHT ADJUSTABLE

| MODEL | LIST | WEIGHT | CUBE            | W  | D  | H  |
|-------|------|--------|-----------------|----|----|----|
|       |      | LBS    | FT <sup>3</sup> | IN | IN | IN |

### 24" DEEP SHROUD FOR 2 LEG HEIGHT ADJUSTABLE DESK

USE WITH ATHENA & CALYPSO BASES, CAL-2448HAX USE WITH ATHENA BASES ONLY

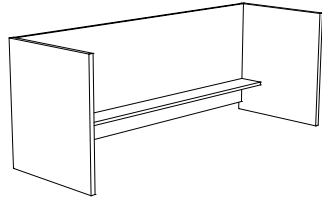

CAL-2472HAX

|             |         |      |     |       |       |    |
|-------------|---------|------|-----|-------|-------|----|
| CAL-2448HAX | \$567   | 60.6 | 2.2 | 47.25 | 23.75 | 27 |
| CAL-2454HAX | \$620   | 64.4 | 2.4 | 53.25 | 23.75 | 27 |
| CAL-2460HAX | \$637   | 68.1 | 2.7 | 59.25 | 23.75 | 27 |
| CAL-2466HAX | \$652   | 71.8 | 2.9 | 65    | 23.75 | 27 |
| CAL-2472HAX | \$666   | 75.5 | 3.2 | 71    | 23.75 | 27 |
| CAL-2478HAX | \$790   | 79.2 | 3.5 | 77    | 23.75 | 27 |
| CAL-2484HAX | \$864   | 82.9 | 3.7 | 82.75 | 23.75 | 27 |
| CAL-2496HAX | \$1,002 | 90.4 | 4.3 | 94.5  | 23.75 | 27 |

- ONLY AVAILABLE WITH A GABLE SETS. CONTACT CUSTOMER SERVICE FOR B OR C GABLES
- MODESTY PANEL HAS A 2" CORD ALLOWANCE GAP. TO ORDER 3/4 MODESTY PANEL - **ADD '3'** TO MODEL NUMBER  
- EXAMPLE CAL-2454HAX-A3
- CONTACT CUSTOMER SERVICE FOR 1/2 HEIGHT MODESTY PANELS

AVAILABLE FINISHES: ALL STANDARD HEARTWOOD FINISHES

### 30" DEEP SHROUD FOR 2 LEG HEIGHT ADJUSTABLE DESK

USE WITH ATHENA & CALYPSO BASES, CAL-3048HAX USE WITH ATHENA BASES ONLY

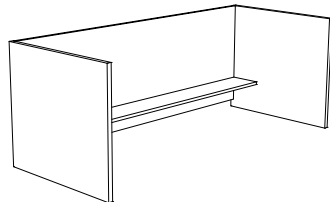

CAL-3072HAX

|             |         |      |     |       |      |    |
|-------------|---------|------|-----|-------|------|----|
| CAL-3048HAX | \$604   | 68.7 | 2.6 | 47.25 | 29.5 | 27 |
| CAL-3054HAX | \$657   | 72.4 | 3   | 53.25 | 29.5 | 27 |
| CAL-3060HAX | \$674   | 76.1 | 3.3 | 59.25 | 29.5 | 27 |
| CAL-3066HAX | \$689   | 79.9 | 3.6 | 65    | 29.5 | 27 |
| CAL-3072HAX | \$703   | 83.6 | 3.9 | 71    | 29.5 | 27 |
| CAL-3078HAX | \$827   | 87.3 | 4.3 | 77    | 29.5 | 27 |
| CAL-3084HAX | \$901   | 91   | 4.6 | 82.75 | 29.5 | 27 |
| CAL-3096HAX | \$1,039 | 98.5 | 5.2 | 94.5  | 29.5 | 27 |

- ONLY AVAILABLE WITH A GABLE SETS. CONTACT CUSTOMER SERVICE FOR B OR C GABLES
- MODESTY PANEL HAS A 2" CORD ALLOWANCE GAP. TO ORDER 3/4 MODESTY PANEL - **ADD '3'** TO MODEL NUMBER  
- EXAMPLE CAL-2454HAX-A3
- CONTACT CUSTOMER SERVICE FOR 1/2 HEIGHT MODESTY PANELS

AVAILABLE FINISHES: ALL STANDARD HEARTWOOD FINISHES

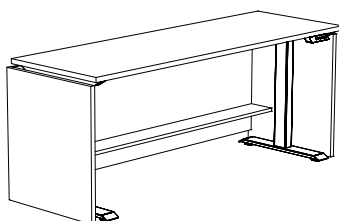

| EXAMPLE 1   |  |
|-------------|--|
| CAL-2472HAX | 24" DEEP SHROUD FOR 2 LEG HEIGHT ADJUSTABLE DESK |
| ATH-E1-2LEG | ATHENA 2 LEG BASE                                |
| CAL-REC2472 | 24" RECTANGLE TOP                                |

| MODEL | LIST | WEIGHT | CUBE            | W  | D  | H  |
|-------|------|--------|-----------------|----|----|----|
|       |      | LBS    | FT <sup>3</sup> | IN | IN | IN |

**24" DEEP SHROUD FOR 3 LEG HEIGHT ADJUSTABLE DESK LEFT**

USE WITH CAL LEFT EXTENDED CORNER MODULE

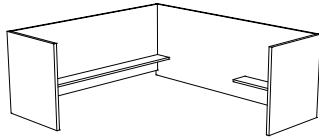

CAL-2466-7224HAX-L

|                    |         |       |     |             |             |    |
|--------------------|---------|-------|-----|-------------|-------------|----|
| CAL-2460-6024HAX-L | \$1,431 | 97.9  | 4.1 | 23.75/59.25 | 59.25/23.75 | 27 |
| CAL-2466-6024HAX-L | \$1,482 | 101.6 | 4.4 | 23.75/65    | 59.25/23.75 | 27 |
| CAL-2472-6024HAX-L | \$1,553 | 105.3 | 4.9 | 23.75/71    | 59.25/23.75 | 27 |
| CAL-2478-6024HAX-L | \$1,712 | 109   | 5.3 | 23.75/77    | 59.25/23.75 | 27 |
| CAL-2484-6024HAX-L | \$2,011 | 112.7 | 5.6 | 23.75/82.75 | 59.25/23.75 | 27 |
| CAL-2460-6624HAX-L | \$1,473 | 100.8 | 4.4 | 23.75/59.25 | 65/23.75    | 27 |
| CAL-2466-6624HAX-L | \$1,524 | 104.5 | 4.4 | 23.75/65    | 65/23.75    | 27 |
| CAL-2472-6624HAX-L | \$1,595 | 108.2 | 4.9 | 23.75/71    | 65/23.75    | 27 |
| CAL-2478-6624HAX-L | \$1,754 | 111.9 | 5.3 | 23.75/77    | 65/23.75    | 27 |
| CAL-2484-6624HAX-L | \$2,053 | 115.6 | 5.6 | 23.75/82.75 | 65/23.75    | 27 |
| CAL-2460-7224HAX-L | \$1,516 | 103.7 | 4.9 | 23.75/59.25 | 71/23.75    | 27 |
| CAL-2466-7224HAX-L | \$1,567 | 107.4 | 4.9 | 23.75/65    | 71/23.75    | 27 |
| CAL-2472-7224HAX-L | \$1,638 | 111.1 | 4.9 | 23.75/71    | 71/23.75    | 27 |
| CAL-2478-7224HAX-L | \$1,797 | 114.8 | 5.3 | 23.75/77    | 71/23.75    | 27 |
| CAL-2484-7224HAX-L | \$2,096 | 118.5 | 5.6 | 23.75/82.75 | 71/23.75    | 27 |

USE WITH CAL RIGHT EXTENDED CORNER MODULE

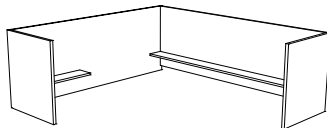

CAL-2472-7824HAX-R

|                    |         |       |     |             |             |    |
|--------------------|---------|-------|-----|-------------|-------------|----|
| CAL-2460-6024HAX-R | \$1,431 | 97.9  | 4.1 | 23.75/59.25 | 59.25/23.75 | 27 |
| CAL-2466-6624HAX-R | \$1,482 | 101.6 | 4.4 | 23.75/59.25 | 65/23.75    | 27 |
| CAL-2460-7224HAX-R | \$1,553 | 105.3 | 4.9 | 23.75/59.25 | 71/23.75    | 27 |
| CAL-2460-7824HAX-R | \$1,712 | 109   | 5.3 | 23.75/59.25 | 77/23.75    | 27 |
| CAL-2460-8424HAX-R | \$2,011 | 112.7 | 5.6 | 23.75/59.25 | 82.75/23.75 | 27 |
| CAL-2466-6024HAX-R | \$1,473 | 100.8 | 4.4 | 23.75/65    | 59.25/23.75 | 27 |
| CAL-2466-6624HAX-R | \$1,524 | 104.5 | 4.4 | 23.75/65    | 65/23.75    | 27 |
| CAL-2466-7224HAX-R | \$1,595 | 108.2 | 4.9 | 23.75/65    | 71/23.75    | 27 |
| CAL-2466-7824HAX-R | \$1,754 | 111.9 | 5.3 | 23.75/65    | 77/23.75    | 27 |
| CAL-2466-8424HAX-R | \$2,053 | 115.6 | 5.6 | 23.75/65    | 82.75/23.75 | 27 |
| CAL-2472-6024HAX-R | \$1,516 | 103.7 | 4.9 | 23.75/71    | 59.25/23.75 | 27 |
| CAL-2472-6624HAX-R | \$1,567 | 107.4 | 4.9 | 23.75/71    | 65/23.75    | 27 |
| CAL-2472-7224HAX-R | \$1,638 | 111.1 | 4.9 | 23.75/71    | 71/23.75    | 27 |
| CAL-2472-7824HAX-R | \$1,797 | 114.8 | 5.3 | 23.75/71    | 77/23.75    | 27 |
| CAL-2472-8424HAX-R | \$2,096 | 118.5 | 5.6 | 23.75/71    | 82.75/23.75 | 27 |

- ONLY AVAILABLE WITH A GABLE SETS. CONTACT CUSTOMER SERVICE FOR B OR C GABLES
- MODESTY PANEL HAS A 2" CORD ALLOWANCE GAP. CONTACT CUSTOMER SERVICE FOR RAISED MODESTIES.

AVAILABLE FINISHES:

ALL STANDARD HEARTWOOD FINISHES

**HEIGHT ADJUSTABLE SERIES**  
**SHROUD - 3 LEG HEIGHT ADJUSTABLE**

| MODEL | LIST | WEIGHT | CUBE            | W  | D  | H  |
|-------|------|--------|-----------------|----|----|----|
|       |      | LBS    | FT <sup>3</sup> | IN | IN | IN |

**30" DEEP SHROUD FOR 3 LEG HEIGHT ADJUSTABLE DESK LEFT**

USE WITH CAL LEFT EXTENDED CORNER MODULE

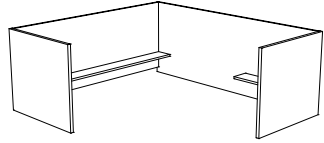

CAL-3066-7230HAX-L

|                    |                |       |     |            |            |    |
|--------------------|----------------|-------|-----|------------|------------|----|
| CAL-3060-6030HAX-L | <b>\$1,503</b> | 105.9 | 4.1 | 29.5/59.25 | 59.25/29.5 | 27 |
| CAL-3066-6030HAX-L | <b>\$1,554</b> | 109.6 | 4.4 | 29.5/65    | 59.25/29.5 | 27 |
| CAL-3072-6030HAX-L | <b>\$1,625</b> | 113.4 | 4.9 | 29.5/71    | 59.25/29.5 | 27 |
| CAL-3078-6030HAX-L | <b>\$1,784</b> | 117.1 | 5.3 | 29.5/77    | 59.25/29.5 | 27 |
| CAL-3084-6030HAX-L | <b>\$2,083</b> | 120.8 | 5.6 | 29.5/82.75 | 59.25/29.5 | 27 |
| CAL-3060-6630HAX-L | <b>\$1,545</b> | 108.8 | 4.4 | 29.5/59.25 | 65/29.5    | 27 |
| CAL-3066-6630HAX-L | <b>\$1,596</b> | 112.5 | 4.4 | 29.5/65    | 65/29.5    | 27 |
| CAL-3072-6630HAX-L | <b>\$1,667</b> | 116.3 | 4.9 | 29.5/71    | 65/29.5    | 27 |
| CAL-3078-6630HAX-L | <b>\$1,826</b> | 120   | 5.3 | 29.5/77    | 65/29.5    | 27 |
| CAL-3084-6630HAX-L | <b>\$2,125</b> | 123.7 | 5.6 | 29.5/82.75 | 65/29.5    | 27 |
| CAL-3060-7230HAX-L | <b>\$1,588</b> | 111.7 | 4.9 | 29.5/59.25 | 71/29.5    | 27 |
| CAL-3066-7230HAX-L | <b>\$1,639</b> | 115.4 | 4.9 | 29.5/65    | 71/29.5    | 27 |
| CAL-3072-7230HAX-L | <b>\$1,710</b> | 119.2 | 4.9 | 29.5/71    | 71/29.5    | 27 |
| CAL-3078-7230HAX-L | <b>\$1,869</b> | 122.9 | 5.3 | 29.5/77    | 71/29.5    | 27 |
| CAL-3084-7230HAX-L | <b>\$2,168</b> | 126.6 | 5.6 | 29.5/82.75 | 71/29.5    | 27 |

USE WITH CAL RIGHT EXTENDED CORNER MODULE

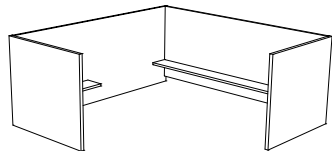

CAL-3066-6630HAX-R

|                    |                |       |     |            |            |    |
|--------------------|----------------|-------|-----|------------|------------|----|
| CAL-3060-6030HAX-R | <b>\$1,503</b> | 105.9 | 4.1 | 29.5/59.25 | 59.25/29.5 | 27 |
| CAL-3060-6630HAX-R | <b>\$1,554</b> | 109.6 | 4.4 | 29.5/59.25 | 65/29.5    | 27 |
| CAL-3060-7230HAX-R | <b>\$1,625</b> | 113.4 | 4.9 | 29.5/59.25 | 71/29.5    | 27 |
| CAL-3060-7830HAX-R | <b>\$1,784</b> | 117.1 | 5.3 | 29.5/59.25 | 77/29.5    | 27 |
| CAL-3060-8430HAX-R | <b>\$2,083</b> | 120.8 | 5.6 | 29.5/59.25 | 82.75/29.5 | 27 |
| CAL-3066-6030HAX-R | <b>\$1,545</b> | 108.8 | 4.4 | 29.5/65    | 59.25/29.5 | 27 |
| CAL-3066-6630HAX-R | <b>\$1,596</b> | 112.5 | 4.4 | 29.5/65    | 65/29.5    | 27 |
| CAL-3066-7230HAX-R | <b>\$1,667</b> | 116.3 | 4.9 | 29.5/65    | 71/29.5    | 27 |
| CAL-3066-7830HAX-R | <b>\$1,826</b> | 120   | 5.3 | 29.5/65    | 77/29.5    | 27 |
| CAL-3066-8430HAX-R | <b>\$2,125</b> | 123.7 | 5.6 | 29.5/65    | 82.75/29.5 | 27 |
| CAL-3072-6030HAX-R | <b>\$1,588</b> | 111.7 | 4.9 | 29.5/71    | 59.25/29.5 | 27 |
| CAL-3072-6630HAX-R | <b>\$1,639</b> | 115.4 | 4.9 | 29.5/71    | 65/29.5    | 27 |
| CAL-3072-7230HAX-R | <b>\$1,710</b> | 119.2 | 4.9 | 29.5/71    | 71/29.5    | 27 |
| CAL-3072-7830HAX-R | <b>\$1,869</b> | 122.9 | 5.3 | 29.5/71    | 77/29.5    | 27 |
| CAL-3072-8430HAX-R | <b>\$2,168</b> | 126.6 | 5.6 | 29.5/71    | 82.75/29.5 | 27 |

- ONLY AVAILABLE WITH A GABLE SETS. CONTACT CUSTOMER SERVICE FOR B OR C GABLES
- MODESTY PANEL HAS A 2" CORD ALLOWANCE GAP. CONTACT CUSTOMER SERVICE FOR RAISED MODESTIES.

AVAILABLE FINISHES:

ALL STANDARD HEARTWOOD FINISHES

| MODEL | LIST | WEIGHT | CUBE            | W  | D  | H  |
|-------|------|--------|-----------------|----|----|----|
|       |      | LBS    | FT <sup>3</sup> | IN | IN | IN |

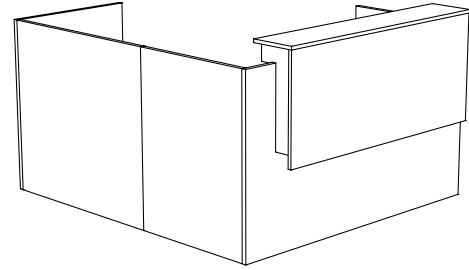
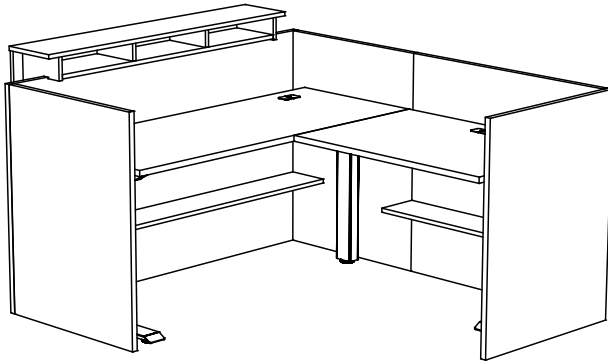

**HEIGHT ADJUSTABLE SHROUD FOR NON-HANDED MODERN RECEPTION DESK**

|                        |                |              |            |           |             |           |
|------------------------|----------------|--------------|------------|-----------|-------------|-----------|
| <b>388-3066MGDS-HA</b> | <b>\$2,560</b> | <b>211.2</b> | <b>7.6</b> | <b>65</b> | <b>35.5</b> | <b>43</b> |
| <b>388-3072MGDS-HA</b> | <b>\$2,740</b> | <b>226.5</b> | <b>8.9</b> | <b>71</b> | <b>35.5</b> | <b>43</b> |

- DESIGNED FOR USE WITH ATHENA & CALYPSO HEIGHT-ADJUSTABLE BASES
- HEIGHT ADJUSTABLE BASE IS REQUIRED TO SUPPORT THE DESK AND/OR RETURN TOPS
- CUTBACK TOP TO CLEAR HORIZONTAL CUBBY

**AVAILABLE FINISHES:**

**ORDERING TIPS:** "TOP & BODY" REFERS TO GALLERY DESK PORTION WHILE "FACE" REFERS TO THE WATERFALL TRANSACTION TOP & FRONT

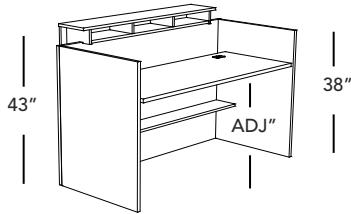

388-3066MGDS-HA

**HEIGHT ADJUSTABLE SHROUD FOR NON-HANDED MODERN RECEPTION RETURN**

|                        |                |              |            |              |             |           |
|------------------------|----------------|--------------|------------|--------------|-------------|-----------|
| <b>388-3036MGRS-HA</b> | <b>\$1,108</b> | <b>90.5</b>  | <b>2.2</b> | <b>35.5</b>  | <b>29.5</b> | <b>38</b> |
| <b>388-3042MGRS-HA</b> | <b>\$1,171</b> | <b>101.2</b> | <b>2.9</b> | <b>41.5</b>  | <b>29.5</b> | <b>38</b> |
| <b>388-3048MGRS-HA</b> | <b>\$1,251</b> | <b>112</b>   | <b>3.7</b> | <b>47.25</b> | <b>29.5</b> | <b>38</b> |

- DESIGNED FOR USE WITH ATHENA & CALYPSO HEIGHT-ADJUSTABLE BASES
- HEIGHT ADJUSTABLE BASE IS REQUIRED TO SUPPORT THE DESK AND/OR RETURN TOPS
- NOT AVAILABLE IN WATERFALL DESIGN

**AVAILABLE FINISHES:**

FOR COMPATIBLE HEIGHT-ADJUSTABLE DESKING OPTIONS, SEE HEIGHT-ADJUSTABLE SERIES PAGE [HT-ADJ-2](#)

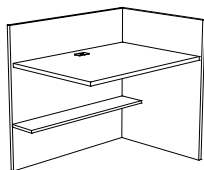

388-3042MGRS-HA

| MODEL | LIST | WEIGHT | CUBE            | W  | D  | H  |
|-------|------|--------|-----------------|----|----|----|
|       |      | LBS    | FT <sup>3</sup> | IN | IN | IN |

**HEIGHT ADJUSTABLE LOCKING CASTER**

SOLD IN QUANTITY OF 2  
M8 THREADED STEM CASTER.

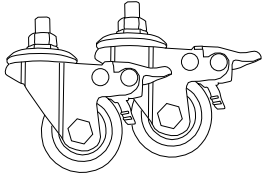

|                                |             |           |           |             |          |            |
|--------------------------------|-------------|-----------|-----------|-------------|----------|------------|
| <b>900-CASTER-M8-HD -QTY 2</b> | <b>\$82</b> | <b>.9</b> | <b>.4</b> | <b>1.75</b> | <b>3</b> | <b>2.5</b> |
|--------------------------------|-------------|-----------|-----------|-------------|----------|------------|

- MAXIMUM WEIGHT PER CASTER IS 30KG/66 LBS.
- DURABLE PVC MATERIAL SAFE FOR USE WITH SOFT OR HARD FLOORS.
- COMPATIBLE WITH CALYPSO, RISE, ATHENA, AND ATLAS MODELS

**FLOOR WIRE MANAGEMENT**

WIRE MANAGEMENT FOR HEIGHT ADJUSTABLE DESKS

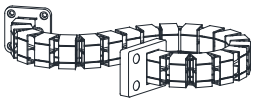

|                   |              |          |            |             |             |              |
|-------------------|--------------|----------|------------|-------------|-------------|--------------|
| <b>100-WM1300</b> | <b>\$127</b> | <b>3</b> | <b>.46</b> | <b>1.75</b> | <b>1.25</b> | <b>51.25</b> |
|-------------------|--------------|----------|------------|-------------|-------------|--------------|

- LENGTH CAN BE EASILY CHANGED BY REMOVING/ADDING LINKS

AVAILABLE FINISH: BLACK (BL), SILVER (SL) & WHITE (WH)



(SHOWN CONFIGURED W/ A DESK SHELL)

**WIRE MANAGEMENT**

12" LONG

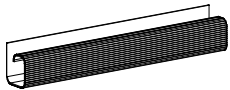

|               |             |          |            |           |            |          |
|---------------|-------------|----------|------------|-----------|------------|----------|
| <b>100-CC</b> | <b>\$20</b> | <b>1</b> | <b>0.1</b> | <b>16</b> | <b>1.5</b> | <b>1</b> |
|---------------|-------------|----------|------------|-----------|------------|----------|

AVAILABLE FINISH: BLACK PLASTIC (BL)

**WIRE MANAGEMENT KIT**

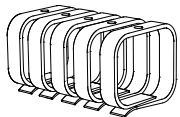

|                 |             |            |            |          |          |            |
|-----------------|-------------|------------|------------|----------|----------|------------|
| <b>100-WIRE</b> | <b>\$73</b> | <b>0.2</b> | <b>0.0</b> | <b>2</b> | <b>2</b> | <b>2.5</b> |
|-----------------|-------------|------------|------------|----------|----------|------------|

AVAILABLE FINISH: LIGHT GREY (GR)

**22" WIRE MANAGEMENT TRAY**

|                  |              |            |            |              |             |             |
|------------------|--------------|------------|------------|--------------|-------------|-------------|
| <b>100-WMT22</b> | <b>\$108</b> | <b>1.9</b> | <b>.19</b> | <b>21.75</b> | <b>7.25</b> | <b>4.75</b> |
|------------------|--------------|------------|------------|--------------|-------------|-------------|

- INTERLOCKING UNITS FOR EASY EXPANSION
- EASY ACCESSIBILITY

AVAILABLE FINISH: WHITE (WH)



| MODEL | LIST | WEIGHT | CUBE            | W  | D  | H  |
|-------|------|--------|-----------------|----|----|----|
|       |      | LBS    | FT <sup>3</sup> | IN | IN | IN |

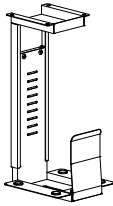

**HANGING CPU HOLDER**

FIXED DESK MOUNT, ADJUSTABLE HANGING CPU HOLDER

|                   |              |          |          |               |             |                     |
|-------------------|--------------|----------|----------|---------------|-------------|---------------------|
| <b>100-2-HCPU</b> | <b>\$188</b> | <b>8</b> | <b>1</b> | <b>3.25-8</b> | <b>8.25</b> | <b>15.375-21.75</b> |
|-------------------|--------------|----------|----------|---------------|-------------|---------------------|

- FIXED LOCATION INSTALL. ADJUSTABLE FOR DIFFERENT CPU WIDTHS ( 3.25" - 8" ) & HEIGHTS (15.375" - 21.75")
- DURABLE HEAVY GAUGE STEEL. MOUNTING HARDWARE INCLUDED.

AVAILABLE FINISHES: BLACK (BL) & WHITE (WH)

**KEYBOARD DRAWER**

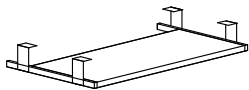

|                 |              |           |          |           |              |             |
|-----------------|--------------|-----------|----------|-----------|--------------|-------------|
| <b>100-KD28</b> | <b>\$202</b> | <b>10</b> | <b>1</b> | <b>28</b> | <b>11.25</b> | <b>3.25</b> |
|-----------------|--------------|-----------|----------|-----------|--------------|-------------|

- WILL WORK ON APOLLO 30" DEEP TOPS ONLY
- WILL WORK ON CALYPSO/ATHENA 24" OR 30" TOPS
- EXTRA WIDTH FOR MOUSE

AVAILABLE FINISHES: ALL STANDARD HEARTWOOD LAMINATE FINISHES

**ARTICULATING KEYBOARD TRAY**

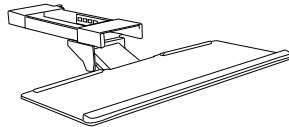

|                |              |             |              |             |           |             |
|----------------|--------------|-------------|--------------|-------------|-----------|-------------|
| <b>100-KB2</b> | <b>\$305</b> | <b>13.8</b> | <b>1.024</b> | <b>26.5</b> | <b>10</b> | <b>6.75</b> |
|----------------|--------------|-------------|--------------|-------------|-----------|-------------|

- HEIGHT ADJUSTMENT (6.75")
- SWIVEL RANGE: -20° TO 20°
- HEAVY-DUTY STEEL CONSTRUCTION PROVIDES EXTRA STRENGTH & DURABILITY

AVAILABLE FINISH: BLACK (BL)

**ARTICULATING KEYBOARD TRAY**

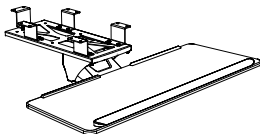

|                   |              |             |             |              |             |               |
|-------------------|--------------|-------------|-------------|--------------|-------------|---------------|
| <b>100-AKTM-2</b> | <b>\$275</b> | <b>12.8</b> | <b>1.14</b> | <b>26.25</b> | <b>9.75</b> | <b>0-4.25</b> |
|-------------------|--------------|-------------|-------------|--------------|-------------|---------------|

- LARGE TRAY - 26"W X 9.7"D. HOLDS UP TO 2.2LBS. HEIGHT ADJ. - 4 1/4" & TILTING ADJ. - 16° / +20°.
- WILL FIT APOLLO, CALYPSO AND ATHENA

AVAILABLE FINISH: BLACK (BL)

**30" x 20" ANTI-FATIGUE MAT**

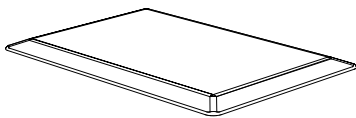

|                    |              |            |            |           |             |          |
|--------------------|--------------|------------|------------|-----------|-------------|----------|
| <b>100-2030AFM</b> | <b>\$157</b> | <b>3.3</b> | <b>.48</b> | <b>29</b> | <b>19.5</b> | <b>1</b> |
|--------------------|--------------|------------|------------|-----------|-------------|----------|

- PVC FAUX LEATHER WITH HIGH-DENSITY POLYURETHANE CORE
- EASY CLEAN
- ABLE TO WITHSTAND COMMON HOUSE FLUIDS SUCH AS GREASE & LIQUIDS
- NON-CURLING BEVELLED EDGES

AVAILABLE FINISH: BLACK (BL)

| MODEL | LIST | WEIGHT | CUBE            | W  | D  | H  |
|-------|------|--------|-----------------|----|----|----|
|       |      | LBS    | FT <sup>3</sup> | IN | IN | IN |

**FINGER TOUCH PNEUMATIC SINGLE MONITOR ARM**

|          |       |     |    |      |      |       |
|----------|-------|-----|----|------|------|-------|
| 100-MA1B | \$405 | 8.4 | .5 | 24.5 | 24.5 | 22.25 |
|----------|-------|-----|----|------|------|-------|

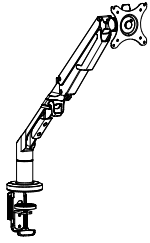

- PREMIUM FINGER TOUCH HEIGHT ADJUSTMENT
- VESA QUICK RELEASE CONNECTION
- 36.0" MAX. MONITOR, LANDSCAPE OR PORTRAIT ORIENTATION
- DESK CLAMP AND GROMMET MOUNT INCLUDED
- RECOMMENDED FOR DEEP WORKSURFACES OR CORNER APPLICATIONS (30+" DEEP)
- 14" HEIGHT ADJUSTMENT RANGE
- 5"-19.0" (LOW/HIGH), 24.0" ARM EXTENSION, 90° MONITOR TILT, 90° VESA ROTATION
- 6.6 LBS.-24.4 LBS. WEIGHT CAPACITY (PER ARM)
- EXCEEDS BIFMA X5.5 REQUIREMENT
- COMPATIBLE WITH OPTIONAL LAPTOP HOLDER **100-LPTP**

**FINGER TOUCH PNEUMATIC DUAL MONITOR ARM**

|          |       |      |     |       |       |       |
|----------|-------|------|-----|-------|-------|-------|
| 100-MA2B | \$585 | 16.3 | .69 | 49.75 | 23.75 | 22.25 |
|----------|-------|------|-----|-------|-------|-------|

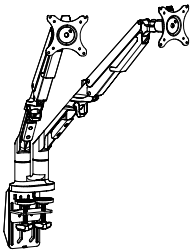

- FINGER TOUCH HEIGHT ADJUSTMENT
- VESA QUICK RELEASE
- 32.0" MAX. MONITOR, LANDSCAPE, PORTRAIT OR COMBINATION OF BOTH
- DESK CLAMP AND GROMMET MOUNT INCLUDED
- RECOMMENDED FOR DEEP WORKSURFACES OR CORNER APPLICATIONS (30+" DEEP)
- 14" HEIGHT ADJUSTMENT RANGE
- 5"-19.0" (LOW/HIGH), 24.0" ARM EXTENSION, 90° MONITOR TILT, 90° VESA ROTATION
- 4.4 LBS.-19.8 LBS. WEIGHT CAPACITY (PER ARM)
- EXCEEDS BIFMA X5.5 REQUIREMENT
- COMPATIBLE WITH OPTIONAL LAPTOP HOLDER **100-LPTP**

AVAILABLE FINISHES: BLACK (BL) & SILVER (SL)

**PNEUMATIC LCD SINGLE MONITOR ARM**

|         |       |   |     |    |    |    |
|---------|-------|---|-----|----|----|----|
| 100-MA1 | \$306 | 8 | 0.5 | 16 | 16 | 18 |
|---------|-------|---|-----|----|----|----|

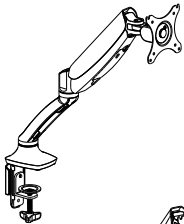

- CAPACITY: 19.8 LBS PER ARM, CLAMP TO DESK OR GROMMET MOUNT
- HOLDS MONITOR SIZE 13" - 30", LANDSCAPE OR PORTRAIT ORIENTATION
- 90 DEGREE SWIVEL ANGLE, 180 DEGREE ROTATION IN BOTH DIRECTIONS, 15 DEGREE TILT ANGLE
- COMPATIBLE WITH OPTIONAL LAPTOP HOLDER **100-LPTP**

**PNEUMATIC LCD DUAL MONITOR ARM**

|         |       |    |     |    |    |    |
|---------|-------|----|-----|----|----|----|
| 100-MA2 | \$436 | 14 | 1.0 | 32 | 16 | 18 |
|---------|-------|----|-----|----|----|----|

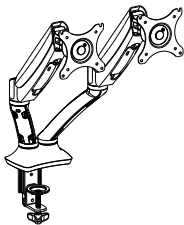

- HOLDS MONITOR SIZE 13" - 30", LANDSCAPE, PORTRAIT OR COMBINATION OF BOTH ORIENTATION

AVAILABLE FINISHES: BLACK (BL) & SILVER (SL)

**NEW!**

**TOOL-FREE DUAL MONITOR ARM**

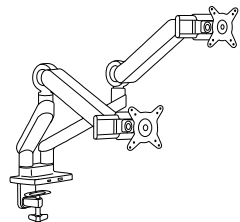

AVAILABLE SOON

**LAPTOP HOLDER ATTACHMENT FOR MONITOR ARM**

|          |       |   |     |    |    |   |
|----------|-------|---|-----|----|----|---|
| 100-LPTP | \$105 | 4 | 0.3 | 12 | 11 | 2 |
|----------|-------|---|-----|----|----|---|

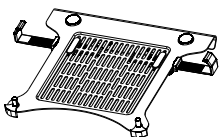

- COMPATIBLE WITH 100-MA1, 100-MA2, 100-MA1B & 100-MA2B MONITOR ARMS. FITS LAPTOP 11" TO 15.6"
- EASY INSTALL

AVAILABLE FINISH: BLACK (BL)



| MODEL | LIST | WEIGHT | CUBE            | W  | D  | H  |
|-------|------|--------|-----------------|----|----|----|
|       |      | LBS    | FT <sup>3</sup> | IN | IN | IN |

**POWER BAR WITH USB**

|                    |              |             |            |              |             |             |
|--------------------|--------------|-------------|------------|--------------|-------------|-------------|
| <b>100-PB6-USB</b> | <b>\$157</b> | <b>1.93</b> | <b>.07</b> | <b>15.75</b> | <b>2.25</b> | <b>1.25</b> |
|--------------------|--------------|-------------|------------|--------------|-------------|-------------|

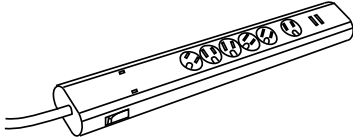

- RATED FOR 15A @ 120V (1800 WATTS)
- USB CHARGER - 2- 2.1AMP PORTS - 5VDC - 2.1A PER PORT. USB CHARGING ONLY.
- 6 - AC 120V GROUND PLUGS
- 10' POWER CORD WITH 90° PLUG
- CUL CERTIFIED FOR USE IN CANADA

AVAILABLE FINISH: BLACK (BL)

**ANGLED DESKTOP POWER GROMMET**

|                     |              |          |            |             |             |             |
|---------------------|--------------|----------|------------|-------------|-------------|-------------|
| <b>100-DTP2-USB</b> | <b>\$332</b> | <b>2</b> | <b>.16</b> | <b>6.25</b> | <b>3.75</b> | <b>3.75</b> |
|---------------------|--------------|----------|------------|-------------|-------------|-------------|

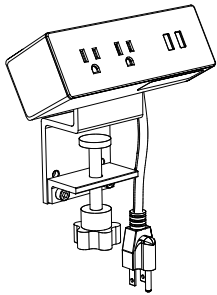

- USB CHARGER: 5V DC 3.1A (15.5 WATTS), 1.5A PER PORT (7.5 WATTS) RATING: 125V 60HZ 15A
- CHARGING ONLY. 10' 14 AWG X 3C POWER CORD.
- CUL CERTIFIED FOR USE IN CANADA. CAN CLAMP THROUGH OUR RECTANGLE GROMMET (CLAMP WIDTH: 60MM)
- 2 - US POWER, 2 - 3.1A USB CHARGING
- 6' POWER CORD

AVAILABLE FINISHES: BLACK (BL) & WHITE (WH)

**UNDERMOUNT POWER BAR WITH USB**

|                        |              |            |            |             |          |             |
|------------------------|--------------|------------|------------|-------------|----------|-------------|
| <b>100-UMNT-USB-AA</b> | <b>\$322</b> | <b>2.4</b> | <b>0.1</b> | <b>7.75</b> | <b>2</b> | <b>2.25</b> |
|------------------------|--------------|------------|------------|-------------|----------|-------------|

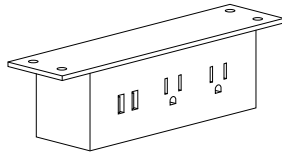

- USB CHARGER: 5V DC 3.1A (15.5 WATTS), 1.5A PER PORT (7.5 WATTS) RATING: 125V 60HZ 15A (1875 WATTS)
- 2 - US POWER, 2 - 3.1A USB CHARGING
- UL CERTIFIED
- 6' POWER CORD

AVAILABLE FINISH: BLACK (BL)

**FLUSH FLIP TOP POWER GROMMET**

|                    |              |          |             |            |            |          |
|--------------------|--------------|----------|-------------|------------|------------|----------|
| <b>100-FTP-USB</b> | <b>\$451</b> | <b>2</b> | <b>0.14</b> | <b>4.3</b> | <b>4.3</b> | <b>2</b> |
|--------------------|--------------|----------|-------------|------------|------------|----------|

- 3 POWER, 1 ETHERNET CAT5E (RJ45) PORT AND 2 USB PORTS. USB PORTS CAN BE USED AS DATA TRANSFER OR CHARGING @ 2.1AMPS

|                     |              |          |             |            |            |          |
|---------------------|--------------|----------|-------------|------------|------------|----------|
| <b>100-FTP-DATA</b> | <b>\$318</b> | <b>2</b> | <b>0.14</b> | <b>4.3</b> | <b>4.3</b> | <b>2</b> |
|---------------------|--------------|----------|-------------|------------|------------|----------|

- 3 POWER, 2 ETHERNET CAT5E (RJ45) PORTS
- STREAMLINE PROFILE WITH HIDDEN RECEPTACLES WHEN IN FLIPPED POSITION
- 10' POWER CORD, UL CERTIFIED.
- LIST PRICE INCLUDES CUSTOM CUTOUT FOR GROMMET INSTALL.

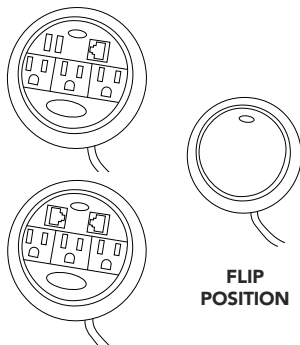

AVAILABLE FINISH: BLACK (BL)

**POWER GROMMET WITH USB**

|                    |              |            |            |             |             |          |
|--------------------|--------------|------------|------------|-------------|-------------|----------|
| <b>100-GRP-USB</b> | <b>\$197</b> | <b>0.8</b> | <b>0.1</b> | <b>2.75</b> | <b>2.75</b> | <b>2</b> |
|--------------------|--------------|------------|------------|-------------|-------------|----------|

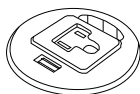

- 1 POWER
- 1 USB PORT. USB CHARGING @ 2.1AMPS OR DATA TRANSFER
- 5' POWER CORD, UL CERTIFIED
- 2.36"/60MM HOLE SIZE
- LIST PRICE INCLUDES CUSTOM CUTOUT FOR GROMMET INSTALL.

AVAILABLE FINISH: BLACK (BL)

| MODEL | LIST | WEIGHT | CUBE            | W  | D  | H  |
|-------|------|--------|-----------------|----|----|----|
|       |      | LBS    | FT <sup>3</sup> | IN | IN | IN |

**DESKTOP HEIGHT ADJUSTABLE**

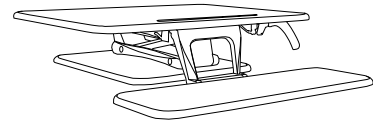

|                 |              |             |            |              |           |                  |
|-----------------|--------------|-------------|------------|--------------|-----------|------------------|
| <b>100-DTHA</b> | <b>\$840</b> | <b>50.3</b> | <b>3.8</b> | <b>26.75</b> | <b>29</b> | <b>6.5-16.75</b> |
|-----------------|--------------|-------------|------------|--------------|-----------|------------------|

- ADJUSTS TO HEIGHTS BETWEEN 6.5" & 16.5" WITH A GAS STRUT FOR EASY CUSTOMIZATION.
- MADE OF WOOD FINISHED WITH A LAMINATE COATING FOR DURABILITY WITH A HEAVY BASE FOR STABILITY
- ADJUSTABLE STAND RESTS ON TOP OF EXISTING DESK TO EASILY CONVERT TRADITIONAL DESK TO STANDING DESK
- COMPATIBLE WITH PNEUMATIC MONITOR ARMS

AVAILABLE FINISH: BLACK (BL)

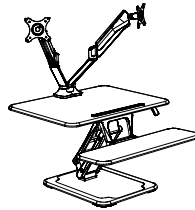

100-DTHA SHOWN WITH 100-MA2

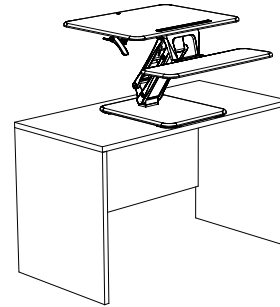

100-DTHA SHOWN WITH 388-2448CT-A2

**DESKTOP HEIGHT ADJUSTABLE**

SIT-TO-STAND DESK CONVERTER W/ GAS-SPRING LIFTING MECHANISM OFFERS EASY ADJUSTMENT

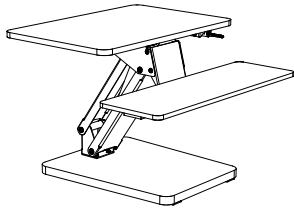

|                   |              |             |             |           |             |                 |
|-------------------|--------------|-------------|-------------|-----------|-------------|-----------------|
| <b>100-2-DTHA</b> | <b>\$480</b> | <b>11.5</b> | <b>1.06</b> | <b>26</b> | <b>24.2</b> | <b>6.3-17.5</b> |
|-------------------|--------------|-------------|-------------|-----------|-------------|-----------------|

- HEAVY-DUTY STEEL & MELAMINE CONSTRUCTION FOR MAXIMUM STABILITY, INCLUDES ANTI-SLIP PADS ON BASE
  - SQUEEZE LEVER HEIGHT-ADJUSTMENT DESIGN
  - WORKSURFACE WEIGHT CAPACITY: 13KG / 28.6 LBS
  - KEYBOARD WEIGHT CAPACITY: 2 KG / 4.4 LBS
  - HEIGHT RANGE 160MM - 445 MM / 6.3" - 17.5"
  - COMPATIBLE WITH PNEUMATIC MONITOR ARMS
- SEE 100-MA1, 100-MA2, 100-MA1B & 100-MA2B**

AVAILABLE FINISH: BLACK (BL)

FOR A COMPLETE LIST OF AVAILABLE ACCESSORIES SEE **100 SERIES**.

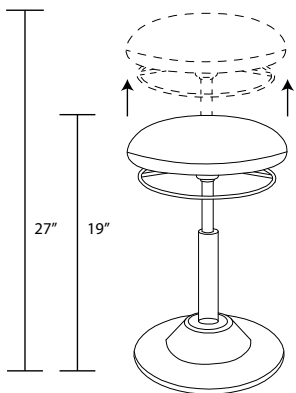

**PLUTO HEIGHT ADJUSTABLE STOOL**

- HEIGHT ADJUSTABLE WOBBLY STOOL
- COMPATIBLE WITH HEIGHT ADJUSTABLE WORK STATIONS BY SUPPORTING YOUR WEIGHT, TAKING THE LOAD OFF YOUR LEGS AND GIVING YOU A REST FROM STANDING
- ROCK, SWIVEL, TILT, LEAN WHILE SITTING
- RESTS UPRIGHT WHEN NOT IN USE
- DOES NOT REQUIRE CONSTANT BALANCING
- SECURELY GRIPS MOST FLOOR SURFACES INCLUDING CARPET, WOOD, AND TILE
- HIGH DENSITY CUSTOM-MOULDED FOAM SEAT
- EASY TO LIFT GAS LIFT MECHANISM
- QUICK ASSEMBLY REQUIRED

|                 |              |             |            |             |             |              |
|-----------------|--------------|-------------|------------|-------------|-------------|--------------|
| <b>PLU-HAPU</b> | <b>\$453</b> | <b>19.6</b> | <b>1.8</b> | <b>14.5</b> | <b>14.5</b> | <b>19-27</b> |
|-----------------|--------------|-------------|------------|-------------|-------------|--------------|

**RECOMMENDED MAX. WEIGHT CAPACITY: 330LBS**

AVAILABLE FINISH: EASY-CLEAN POLYURETHANE BLACK (BL)

HEIGHT ADJUSTABLE

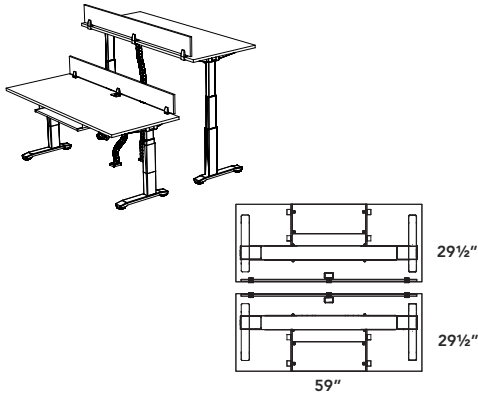

**LAYOUT 1**

|                    |                                      |    |                |
|--------------------|--------------------------------------|----|----------------|
| <b>EM1-0866LAP</b> | 8" EDGE MOUNT LAMINATE PRIVACY PANEL | X2 | <b>\$240</b>   |
| <b>CAL-E1-2LEG</b> | HEIGHT ADJUSTABLE 2 LEG BASE         | X2 | <b>\$1,364</b> |
| <b>CAL-REC3066</b> | 30" RECTANGLE TOP                    | x2 | <b>\$439</b>   |
| <b>100-WM1300</b>  | FLOOR WIRE MANAGEMENT                | X2 | <b>\$127</b>   |
| <b>100-KD28</b>    | KEYBOARD DRAWER                      | X2 | <b>\$202</b>   |
| <b>TOTAL</b>       |                                      |    | <b>\$4,744</b> |

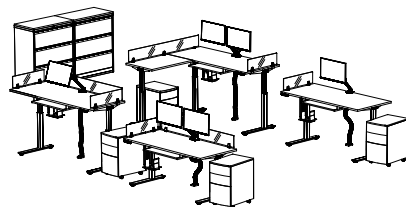

**LAYOUT 2**

**HEARTWOOD COMPONENTS**

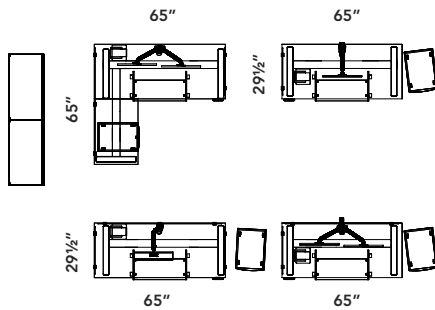

|                      |  |    |                 |
|----------------------|--|----|-----------------|
| <b>EM1-0830PLX</b>   | 8" EDGE MOUNT PLEXIGLASS PRIVACY PANEL | X5 | <b>\$224</b>    |
| <b>EM1-0866PLX</b>   | 8" EDGE MOUNT PLEXIGLASS PRIVACY PANEL | X3 | <b>\$350</b>    |
| <b>CAL-REC3066</b>   | 30" RECTANGLE TOP                      | X4 | <b>\$439</b>    |
| <b>CAL-RS2436</b>    | 24" RETURN TOP                         |    | <b>\$204</b>    |
| <b>ATH-E1-2LEG</b>   | ATHENA 2 LEG BASE                      | X3 | <b>\$1060</b>   |
| <b>ATH-E1-3LEG</b>   | ATHENA 3 LEG BASE                      |    | <b>\$1527</b>   |
| <b>100-2-HCPU</b>    | HANGING CPU HOLDER                     | X4 | <b>\$188</b>    |
| <b>100-WM1300</b>    | FLOOR WIRE MANAGEMENT                  | X4 | <b>\$127</b>    |
| <b>100-MA2</b>       | PNEUMATIC LCD DUAL MONITOR ARM         | X2 | <b>\$436</b>    |
| <b>100-MA1</b>       | PNEUMATIC LCD SINGLE MONITOR ARM       | X2 | <b>\$306</b>    |
| <b>100-KD28</b>      | KEYBOARD DRAWER                        | X4 | <b>\$202</b>    |
| <b>100-MMPUF</b>     | METAL MOBILE PEDESTAL - FULL CARTON    | X4 | <b>\$540</b>    |
| <b>*100-M1936LF3</b> | METAL 3 DRAWER LATERAL FILE            | X2 | <b>\$1278</b>   |
| <b>*TTN-1936TOP</b>  | LAMINATE TOP FOR METAL LATERAL FILES   | X2 | <b>\$107</b>    |
| <b>TOTAL</b>         |  |    | <b>\$17,319</b> |

\*SEE HDL PRICE BOOK FOR MORE DETAILS ON TITAN METAL LATERAL FILES & LAMINATE TOPS

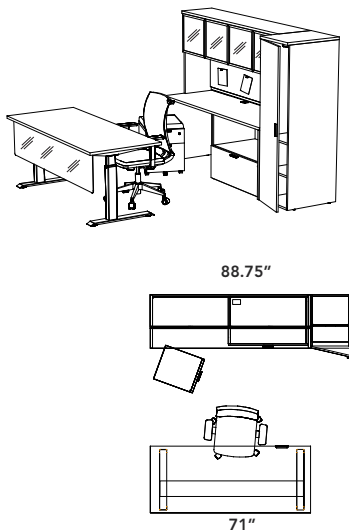

**LAYOUT 3**

|                           |  |  |                |
|---------------------------|--|--|----------------|
| <b>388-2472CT-A</b>       | 24" CONNECTOR TOP                              |  | <b>\$801</b>   |
| <b>388-3672HHD-AGD-FR</b> | 36" HUTCH W/ DOORS & DIVIDER                   |  | <b>\$1,393</b> |
|                           | <i>ALUMINIUM GLASS DOOR UPCHARGE</i>           |  | <b>\$893</b>   |
| <b>388-3672TB</b>         | TACK BOARD FOR 36" HUTCHES                     |  | <b>\$357</b>   |
| <b>388-1936OLFX</b>       | OPEN LATERAL FILE STORAGE - NO TOP             |  | <b>\$962</b>   |
| <b>388-6518CLC-L-24</b>   | SINGLE DOOR CLOSET CABINET                     |  | <b>\$1,862</b> |
| <b>388-1622MPF</b>        | MOBILE B/F PEDESTAL                            |  | <b>\$834</b>   |
| <b>WRK-MPEDCUSH-ESC</b>   | PEDESTAL CUSHION                               |  | <b>\$393</b>   |
| <b>CAL-E1-2LEG</b>        | STRAIGHT ELECTRIC HEIGHT ADJUSTABLE 2 LEG BASE |  | <b>\$1,364</b> |
| <b>CAL-REC3072</b>        | 30" RECTANGLE TOP                              |  | <b>\$453</b>   |
| <b>CAL-MP1660PLX</b>      | 16" PLEXIGLASS HANGING MODESTY PANEL           |  | <b>\$491</b>   |
| <b>TOTAL</b>              |  |  | <b>\$9,803</b> |

\*SEE HDL PRICE BOOK FOR MORE DETAILS ON INNOVATIONS PLEXIGLASS MODESTY PANELS.

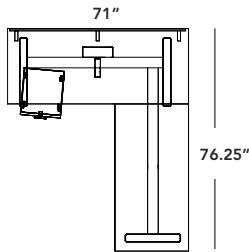
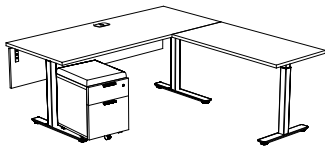

**LAYOUT 4**

|                         |                     |                |
|-------------------------|---------------------|----------------|
| <b>CAL-REC3072</b>      | 30" RECTANGLE TOP   | <b>\$453</b>   |
| <b>CAL-RS2448</b>       | 24" RETURN TOP      | <b>\$246</b>   |
| <b>388-1622MPF</b>      | MOBILE B/F PEDESTAL | <b>\$834</b>   |
| <b>WRK-MPEDCUSH-ESC</b> | PEDESTAL CUSHION    | <b>\$393</b>   |
| <b>CAL-MP1872LAP</b>    | 18" HIGH MODESTY    | <b>\$297</b>   |
| <b>ATH-E1-3LEG</b>      | ATHENA 3 LEG BASE   | <b>\$1527</b>  |
| <b>TOTAL</b>            |                     | <b>\$3,750</b> |

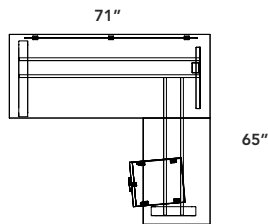
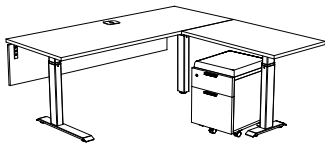

**LAYOUT 5**

|                         |  |                |
|-------------------------|--|----------------|
| <b>CAL-REC3072</b>      | 30" RECTANGLE TOP                              | <b>\$453</b>   |
| <b>CAL-RS2436</b>       | 24" RETURN TOP                                 | <b>\$204</b>   |
| <b>388-1622MPF</b>      | MOBILE B/F PEDESTAL                            | <b>\$834</b>   |
| <b>WRK-MPEDCUSH-ESC</b> | PEDESTAL CUSHION                               | <b>\$393</b>   |
| <b>CAL-MP1872LAP</b>    | 18" HIGH MODESTY                               | <b>\$297</b>   |
| <b>CAL-E1-3LEG</b>      | L SHAPED ELECTRIC HEIGHT ADJUSTABLE 3 LEG BASE | <b>\$1,988</b> |
| <b>TOTAL</b>            |  | <b>\$4,169</b> |

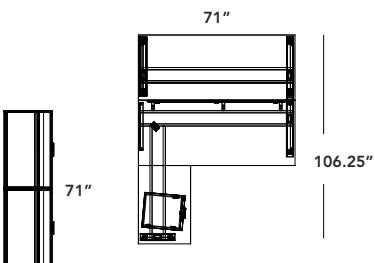
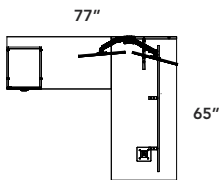
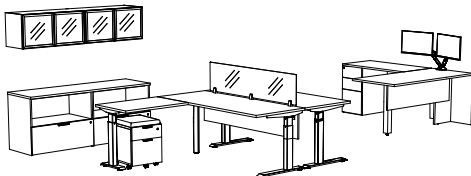

**LAYOUT 6**

|                            |  |                 |
|----------------------------|--|-----------------|
| <b>388-1972FC</b>          | FILE CABINET TOP                               | <b>\$361</b>    |
| <b>388-1936OLFX</b>        | OPEN LATERAL FILE STORAGE - NO TOP             | X2 <b>\$962</b> |
| <b>388-1872OSHD-AGD-FR</b> | OVERHEAD STORAGE WITH HINGED DOORS             | <b>\$1,290</b>  |
|                            | <i>AGD UPCHARGE</i>                            | <b>\$893</b>    |
| <b>CAL-E1-2LEG</b>         | STRAIGHT ELECTRIC HEIGHT ADJUSTABLE 2 LEG BASE | <b>\$1,364</b>  |
| <b>CAL-E1-3LEG</b>         | L SHAPED ELECTRIC HEIGHT ADJUSTABLE 3 LEG BASE | <b>\$1,988</b>  |
| <b>388-1622MPF</b>         | MOBILE B/F PEDESTAL                            | <b>\$834</b>    |
| <b>WRK-MPEDCUSH-HEA</b>    | PEDESTAL CUSHION                               | <b>\$393</b>    |
| <b>388-3066RBTG</b>        | RECTANGULAR BULLET TOP                         | <b>\$888</b>    |
| <b>388-19FPUFX</b>         | FREESTANDING PEDESTAL - NO TOP                 | <b>\$871</b>    |
| <b>FLXS-REC2448</b>        | 24" RECTANGLE TOP                              | <b>\$246</b>    |
| <b>CAL-REC3072</b>         | 30" RECTANGLE TOP                              | X2 <b>\$453</b> |
| <b>CAL-RS2448</b>          | 24" RETURN TOP                                 | <b>\$246</b>    |
| <b>CAL-MP1866LAP</b>       | 18" LAMINATE MODESTY PANELS                    | X2 <b>\$282</b> |
| <b>TM1-1566PLX</b>         | 15" TOP MOUNT PLEXIGLASS PRIVACY PANEL         | <b>\$546</b>    |
| <b>100-MA2</b>             | PNEUMATIC LCD DUAL MONITOR ARM                 | <b>\$436</b>    |
| <b>WRK-WFBK</b>            | WORK SURFACE FLUSH BRACKET KIT                 | X2 <b>\$36</b>  |
| <b>TOTAL</b>               |  | <b>\$13,822</b> |

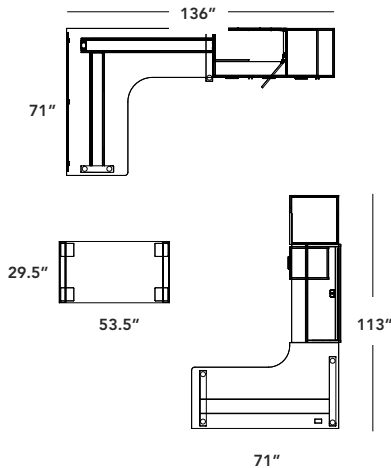
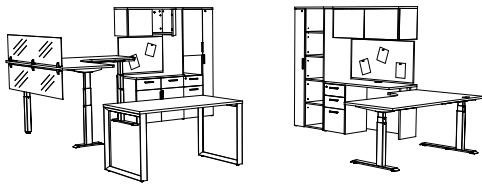

**LAYOUT #7**

|                           |  |    |                 |
|---------------------------|--|----|-----------------|
| <b>388-1836OSHD</b>       | OVERHEAD STORAGE W/ HINGED DOORS               |    | <b>\$782</b>    |
| <b>388-6530COUFWR-24</b>  | CABINET/OPEN SHELF/BOX/BOX/FILE/WARDROBE RIGHT |    | <b>\$2,139</b>  |
| <b>388-2436DC</b>         | DRAWERS OVER DOUBLE DOOR CABINETS              |    | <b>\$1,368</b>  |
| <b>388-3636TB</b>         | TACK BOARD                                     |    | <b>\$237</b>    |
| <b>CAL-E1-3LEG</b>        | L SHAPED ELECTRIC HEIGHT ADJUSTABLE 3 LEG BASE |    | <b>\$1,988</b>  |
| <b>CAL-3072-7224RCMLD</b> | ONE PIECE L-SHAPE TOP                          |    | <b>\$1,364</b>  |
| <b>TM1-1572PLX</b>        | 15" TOP MOUNT PLEXIGLASS PRIVACY PANEL         |    | <b>\$605</b>    |
| <b>CAL-MP1672PLX</b>      | 16" PLEXIGLASS HANGING MODESTY PANEL           |    | <b>\$538</b>    |
| <b>900-LOOP30</b>         | 30" METAL LOOP LEG                             | X2 | <b>\$207</b>    |
| <b>FLXS-REC3054</b>       | 30" RECTANGLE TOPS                             |    | <b>\$337</b>    |
| <b>388-6524OWL-24</b>     | OPEN SHELVES/WARDROBE LEFT                     |    | <b>\$1,408</b>  |
| <b>388-1848OSHD</b>       | OVERHEAD STORAGE W/ HINGED DOORS               |    | <b>\$896</b>    |
| <b>388-2448CT-B</b>       | 24" CONNECTOR TOP                              |    | <b>\$672</b>    |
| <b>388-19FPUFX</b>        | FREESTANDING PEDESTAL - NO TOP                 |    | <b>\$871</b>    |
| <b>388-4348TB</b>         | TACK BOARD                                     |    | <b>\$353</b>    |
| <b>CAL-E1-2LEG</b>        | STRAIGHT ELECTRIC HEIGHT ADJUSTABLE 2 LEG BASE |    | <b>\$1,364</b>  |
| <b>CAL-RCM2442-7230</b>   | RH EXTENDED CORNER MODULE TOP                  |    | <b>\$734</b>    |
| <b>CAL-E1-2LEG-CMF</b>    | CORNER MODULE FOOT                             |    | <b>\$212</b>    |
| <b>TOTAL</b>              |  |    | <b>\$16,282</b> |

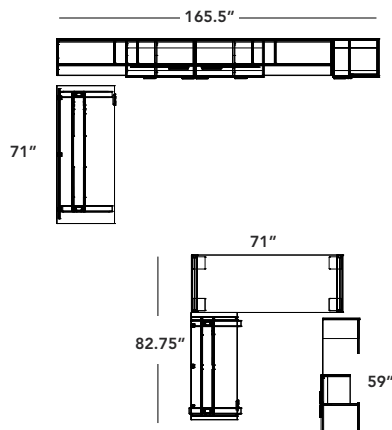
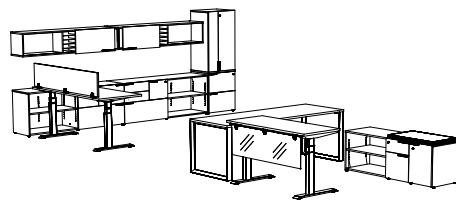

**LAYOUT #8**

|                           |  |    |                 |
|---------------------------|--|----|-----------------|
| <b>CAL-E1-2LEG</b>        | STRAIGHT ELECTRIC HEIGHT ADJUSTABLE 2 LEG BASE           | X2 | <b>\$1,364</b>  |
| <b>CAL-REC3072</b>        | 30" RECTANGLE TOP  |    | <b>\$453</b>    |
| <b>TM1-1572TBP</b>        | 15" TOP MOUNT TACK BOARD PRIVACY PANEL                   |    | <b>\$731</b>    |
| <b>WRK-CO2072FUL-27</b>   | 27" HIGH OPEN SHELF, FILE/BOX/BOX/LATERAL FILE CREDENZAS |    | <b>\$2,119</b>  |
| <b>WRK-UFL2072CO-27</b>   | 27" HIGH BOX/BOX/FILE/LATERAL FILE, OPEN SHELF CREDENZAS |    | <b>\$2,119</b>  |
| <b>WRK-7124WCSLF20-L</b>  | WARDROBE CABINET/STORAGE OVER LATERAL FILES              |    | <b>\$2,205</b>  |
| <b>WRK-1572OSSD-L-COL</b> | OVERHEAD STORAGE W/ SLIDING DOOR - HANDLE LEFT           |    | <b>\$1,202</b>  |
|                           | OPTIONAL PLEXIGLASS COLLATOR                             |    | <b>\$369</b>    |
| <b>WRK-1572OSSD-R-COL</b> | OVERHEAD STORAGE W/ SLIDING DOOR - HANDLE RIGHT          |    | <b>\$1,202</b>  |
|                           | OPTIONAL PLEXIGLASS COLLATOR                             |    | <b>\$369</b>    |
| <b>FLXS-REC3072</b>       | 30" RECTANGLE TOPS                                       |    | <b>\$437</b>    |
| <b>900-LOOP30</b>         | 30" METAL LOOP LEG                                       | X2 | <b>\$207</b>    |
| <b>CAL-REC2454</b>        | 24" RECTANGLE TOP  |    | <b>\$363</b>    |
| <b>CAL-MP1648PLX</b>      | 16" PLEXIGLASS HANGING MODESTY PANEL                     |    | <b>\$428</b>    |
| <b>WRK-CO2060FC-21</b>    | 21" HIGH OPEN SHELF, BOX/ FILE/CABINET CREDENZAS         |    | <b>\$1,671</b>  |
| <b>WRK-2030CUSH-ESC</b>   | SEAT CUSHIONS FOR 21" HIGH CREDENZAS                     |    | <b>\$457</b>    |
| <b>TOTAL</b>              |  |    | <b>\$17,267</b> |

**LAYOUT #9**

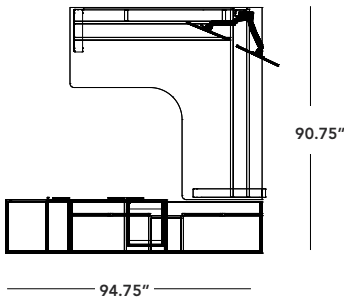
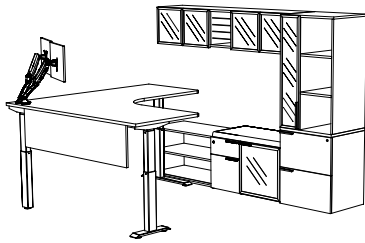

|                                  |  |                |
|----------------------------------|--|----------------|
| <b>CAL-3072-7230RCMLD</b>        | ONE PIECE L-SHAPED TOP                           | <b>\$1,443</b> |
| <b>CAL-E1-3LEG</b>               | L SHAPED ELECTRIC HEIGHT ADJUSTABLE 3 LEG BASE   | <b>\$1,988</b> |
| <b>CAL-MP1866LAP</b>             | 18" LAMINATE MODESTY PANELS                      | <b>\$282</b>   |
| <b>100-MA2</b>                   | PNEUMATIC LCD DUAL MONITOR ARM                   | <b>\$436</b>   |
| <b>WRK-CO2072FC-21-AGD-FR</b>    | 21" HIGH OPEN SHELF, BOX/ FILE/CABINET CREDENZAS | <b>\$1,827</b> |
|                                  | <i>AGD UP-CHARGE</i>                             | <b>\$276</b>   |
| <b>WRK-2036CUSH-ESC</b>          | SEAT CUSHIONS FOR 21" HIGH CREDENZAS             | <b>\$457</b>   |
| <b>WRK-1572OSHD-AGD-FR-COL</b>   | OVERHEAD STORAGE W/ HINGED DOORS                 | <b>\$1,216</b> |
|                                  | <i>AGD UP-CHARGE</i>                             | <b>\$834</b>   |
|                                  | <i>OPTIONAL PLEXIGLASS COLLATOR</i>              | <b>\$369</b>   |
| <b>WRK-7124WCBKLF20-L-AGD-FR</b> | WARDROBE CABINET/BOOKCASE OVER LATERAL FILES     | <b>\$2,309</b> |
|                                  | <i>AGD UP-CHARGE</i>                             | <b>\$406</b>   |

**TOTAL \$11,843**

**LAYOUT #10**

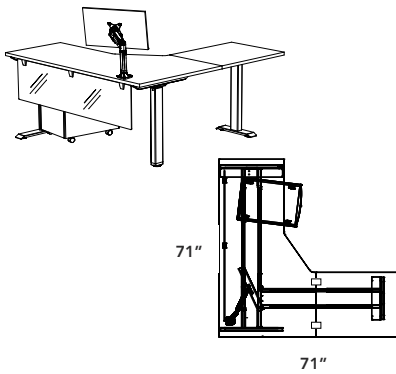

|                        |                                      |               |
|------------------------|--------------------------------------|---------------|
| <b>CAL-CM2436-7224</b> | RH EXTENDED CORNER MODULE TOP        | <b>\$625</b>  |
| <b>CAL-RS2436</b>      | 24" RETURN TOP                       | <b>\$204</b>  |
| <b>ATH-E1-3LEG</b>     | ATHENA 3 LEG BASE                    | <b>\$1527</b> |
| <b>CAL-MP1666PLX</b>   | 16" PLEXIGLASS HANGING MODESTY PANEL | <b>\$511</b>  |
| <b>100-MMPF</b>        | METAL MOBILE PEDESTAL - FULL CARTON  | <b>\$499</b>  |
| <b>100-MMPF-CUSHFA</b> | METAL MOBILE PEDESTAL CUSHION        | <b>\$133</b>  |
| <b>100-MA1</b>         | PNEUMATIC LCD SINGLE MONITOR ARM     | <b>\$306</b>  |

**TOTAL \$3,805**

**LAYOUT #11**

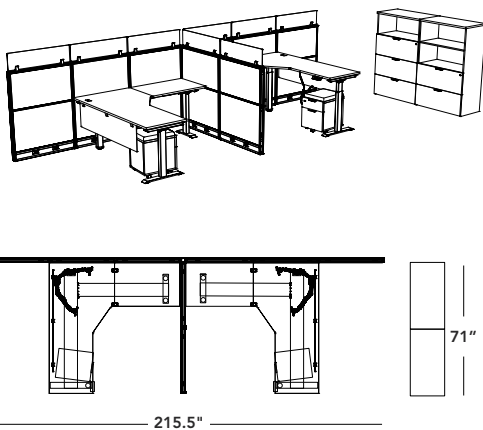

|                         |  |    |                |
|-------------------------|--|----|----------------|
| <b>ATH-E1-3LEG</b>      | L SHAPED ELECTRIC HEIGHT ADJUSTABLE 3 LEG BASE | X2 | <b>\$1527</b>  |
| <b>CAL-CM2472-3624</b>  | LH EXTENDED CORNER MODULE TOP                  |    | <b>\$625</b>   |
| <b>CAL-CM2436-7224</b>  | RH EXTENDED CORNER MODULE TOP                  |    | <b>\$625</b>   |
| <b>CAL-RS2436</b>       | 24" RETURN TOP                                 | X2 | <b>\$204</b>   |
| <b>388-1622MPPF</b>     | MOBILE B/F PEDESTAL                            | X2 | <b>\$834</b>   |
| <b>WRK-MPEDCUSH-ESC</b> | PEDESTAL CUSHION                               | X2 | <b>\$393</b>   |
| <b>CAL-MP1666PLX</b>    | 16" PLEXIGLASS HANGING MODESTY PANEL           | X2 | <b>\$511</b>   |
| <b>388-2036OLF4</b>     | OPEN TALL LATERAL FILE STORAGE                 |    | <b>\$2,274</b> |
| <b>388-2036O2LF4</b>    | OPEN TALL LATERAL FILE STORAGE                 |    | <b>\$2,027</b> |

**HDL ITEMS**

|                     |                              |    |              |
|---------------------|------------------------------|----|--------------|
| <b>FRM-3648P</b>    | 48" TALL PANEL               | X8 | <b>\$490</b> |
| <b>FRM-48SQP-3W</b> | SQUARE 3 WAY CONNECTING POST |    | <b>\$104</b> |
| <b>FRM-48PET</b>    | PANEL END TRIM               | X3 | <b>\$29</b>  |
| <b>FRM-PCK</b>      | PANEL CONNECTING KIT         | X5 | <b>\$40</b>  |
| <b>FRM-1036PLX</b>  | PLEXIGLASS PANEL EXTENSION   | X8 | <b>\$159</b> |

**TOTAL \$18,072**

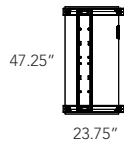
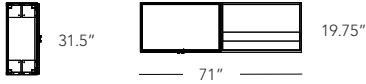
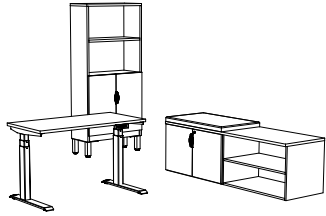

**LAYOUT #12**

|                         |                                       |                |
|-------------------------|---------------------------------------|----------------|
| <b>LEV-2448-CAL-2L</b>  | CALYPSO HEIGHT ADJUSTABLE DESK        | <b>\$1,784</b> |
| <b>LEV-2036CX-21</b>    | 21" HIGH DOUBLE DOOR CABINET - NO TOP | <b>\$852</b>   |
| <b>LEV-2036COX-21</b>   | OPEN CABINET - NO TOP                 | <b>\$801</b>   |
| <b>LEV-2072FC</b>       | FILE CABINET TOP                      | <b>\$361</b>   |
| <b>LEV-2036CUSH-ESC</b> | SEAT CUSHIONS FOR 21" HIGH CREDENZAS  | <b>\$457</b>   |

**HDL PRODUCTS**

|                     |                             |              |
|---------------------|-----------------------------|--------------|
| <b>LEV-SR7232BK</b> | BOOKCASE                    | <b>\$724</b> |
| <b>LEV-32BKDRS</b>  | OPTIONAL DOORS FOR BOOKCASE | <b>\$205</b> |

**TOTAL \$5,184**

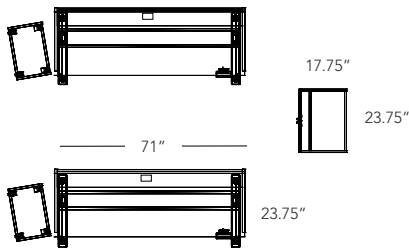
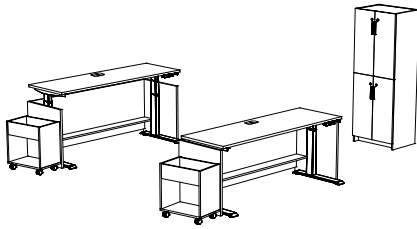

**LAYOUT #13**

|                       |  |                   |
|-----------------------|--|-------------------|
| <b>LOC-6524C4-18</b>  | 65" TALL - 2 WIDE, 2 DOOR LOCKER                 | <b>\$2,417</b>    |
| <b>CAL-2472HAX</b>    | 24" DEEP SHROUD FOR 2 LEG HEIGHT ADJUSTABLE DESK | <b>X2 \$666</b>   |
| <b>CAL-REC2472</b>    | 24" RECTANGLE TOP                                | <b>X2 \$414</b>   |
| <b>CAL-E1-2LEG</b>    | HEIGHT ADJUSTABLE 2 LEG BASE                     | <b>X2 \$1,364</b> |
| <b>388-1320MSO-22</b> | MOBILE STORAGE OPEN                              | <b>X2 \$743</b>   |

**TOTAL \$8,791**

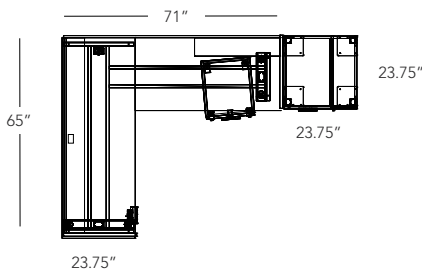
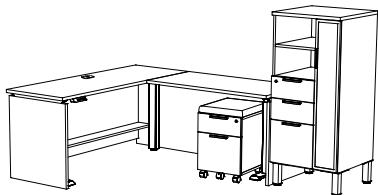

**LAYOUT #14**

|                                  |   |                |
|----------------------------------|---|----------------|
| <b>CAL-2466-7224HAX-L</b>        | 24" SHROUD FOR 3 LEG HEIGHT ADJUSTABLE DESK LT    | <b>\$1,567</b> |
| <b>CAL-REC2466</b>               | 24" RECTANGLE TOP                                 | <b>\$398</b>   |
| <b>CAL-REC2448</b>               | 24" RECTANGLE TOP                                 | <b>\$290</b>   |
| <b>ATH-E1-3LEG</b>               | ATHENA 3 LEG BASE                                 | <b>\$1527</b>  |
| <b>LEV-5524OUFWR-24-SR - AGD</b> | MID-HEIGHT OPEN WARDROBE STORAGE W/ STORAGE RISER | <b>\$1,620</b> |
|                                  | AGD UPCHARGE                                      | <b>\$544</b>   |
| <b>LEV-1622MPF</b>               | MOBILE PEDESTAL                                   | <b>\$834</b>   |
| <b>LEV-MPEDCUSH-ESC</b>          | PEDESTAL CUSHION                                  | <b>\$393</b>   |

**TOTAL \$7,173**

NOTES:

---



# TEAM SERIES

This is a metric series (imperial sizing available). Please refer to page [INDEX-1](#) for details

- TEAM Series** .....
  - Summary ..... [TEM -3](#)
- Team Power Wall** .....
  - Specifications ..... [TEM -4](#)
    - 4 Pod Power Walls ..... [TEM -5](#)
    - 6 Pod Power Walls ..... [TEM -7](#)
    - Tack boards ..... [TEM -9](#)
    - Layouts ..... [TEM -10](#)
- Team Stations** .....
  - Specifications ..... [TEM -11](#)
    - 4 Pod Team Stations ..... [TEM -12](#)
    - 6 Pod Team Stations ..... [TEM -12](#)
    - Layouts ..... [TEM -13](#)
- TEAM Power Line** .....
  - Specifications ..... [TEM -14](#)
    - Electrical Receptacles ..... [TEM -15](#)
    - Electrical Jumpers ..... [TEM -16](#)
    - Layouts ..... [TEM -16](#)
- Team Study Carrels** .....
  - Specifications ..... [TEM -17](#)
    - Laminate Study Carrels ..... [TEM -18](#)
    - Layouts ..... [TEM -19](#)



### Team Power Wall

Modular workspace divider system specifically tailored to the needs of height-adjustable workstations. The integrated electrical wire management channel blends form with function, accommodate individual workflows, all levels of collaboration and different mobility needs. Team up your stations with a power wall.

Sold as 4 or 6 pod configurations with optional 6" or 12" high plexiglass privacy extension. For larger pod configurations, contact customer service for a quote.

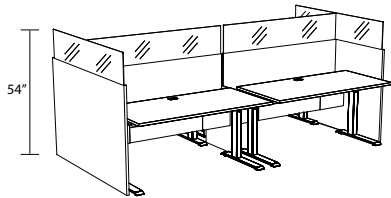

**Shown:** TEM-3060PW4-B42-PX12 with Calypso Desks (Sold Separately)

### Team Stations

Modern, open office configurations are ideally suited to teaming stations and at Heartwood Manufacturing we have made the option as easy as possible. This popular desking design allows for a collaborative, space-saving working environment while maintaining a degree of individual privacy.

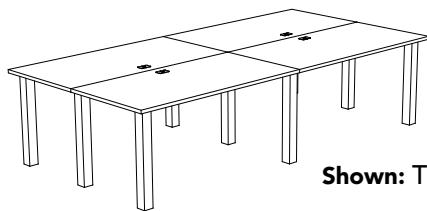

**Shown:** TEM-REC3060-4

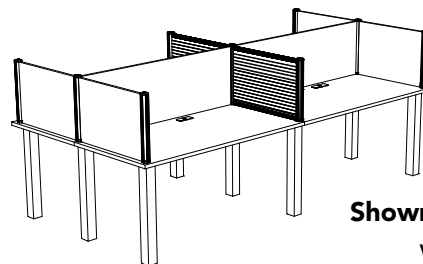

**Shown:** TEM-REC3060-4 with Outlines

### Team Power Line

Power Line is designed to provide useful solutions to power and charging needs in the workspace. Seamlessly integrate power receptacles, USB charging and other power sources are in a daisy chain design that gets power where you need it. Although designed as a teaming station power solution, this design is effective in numerous workstation scenarios.

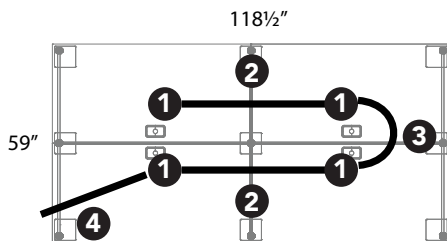

### Team Study Carrels

The timeless design of the traditional study carrel proves how effective a workspace option it is. Heartwood's Team study carrels are a modern approach to this classic design. Pick your size and team up your study carrels.

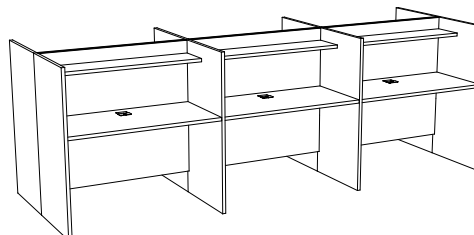
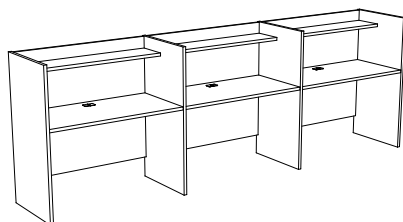

**NOTE:** Information is current at time of print. For up to date information check online at [www.heartwood.ca](http://www.heartwood.ca).

# TEAM POWER WALL

## SPECIFICATIONS & DESCRIPTION

Modular workspace divider system specifically tailored to the needs of height-adjustable workstations. The integrated electrical wire management channel blends form with function, accommodate individual workflows, all levels of collaboration and different mobility needs. Team up your stations with a power wall. Sold as 4 or 6 pod configurations with optional 6" or 12" high plexiglass privacy extension. For larger pod configurations, contact customer service for a quote.

### FEATURES

- ♥ Convenient laminate wire management channel with flip-down hinged access door on each station.
- ♥ Wires can be fed through access openings.
- ♥ Add the new multi power bar (100-PB6-USB) to run down the center channel. For additional power requirements, add surface mounted power grommets or clamp-on power onto worksurface and feed into wire management channel.
- ♥ Assembly required.
- ♥ **Work Station size indicates the size of the intended desking unit used with the power wall. For example 72" workstations are designed to work with 72" wide height adjustable desking units. (Heartwood Sizes equal the metric equivalent - standard 72" desk measures 71")** See [Height Adjustable](#).  
Example TEM-2448PW4-B42 is designed to fit 4 sit-to-stand desks 24 x 48 in size

### CONSTRUCTION

- ♥ 1" gables all other parts ¾"
- ♥ Two available gable sets, standard laminate gable height is 42" or 54" high
- ♥ 6" (PX6) or 12" (PX12) plexiglass panel extensions can be added to standard laminate gables
- ♥ Two-tone laminate option available
- ♥ All are thermally fused laminate on a 45lb industrial particleboard core.
- ♥ One centre grommet in laminate wire management channel
- ♥ Channel includes access door with wire slot
- ♥ 12" clearance to underside of wire management channel
- ♥ Leveling glides are standard on all floor models.

### GABLE SETS

- ♥ A gable set - all gables standard height (42" or 54") and equal depth
- ♥ B gable set - inside gables or mate gable is 28" high and 24" deep

### EDGE DETAIL

- ♥ Exposed edges all finished in a matching 2mm edge band.
- ♥ Banding changes to an alternate Heartwood standard colour are available at no extra charge.

### PLEXIGLASS PANELS

- ♥ Plexiglass panels 6" or 12" height – add -PX6 or -PX12 to sku
- ♥ Available plexiglass finishes: **default frosted (FR)** clear (**CL**), or Bronze (**BR**) plexiglass. Please note finish selection on your PO.
- ♥ Plexi to be 1" from gable ends,
- ♥ Plexi to be ¼" from partition ends

### ACCESSORIES

- ♥ Optional tack boards available
  - Tack boards can be installed on both sides of the center divider
  - For current tack board finish options, please see [Heartwood.ca](#) finishes.
- ♥ Optional accessories - power grommets, power bar, wire management etc. are compatible with this series. See [100 Series - Accessories](#)

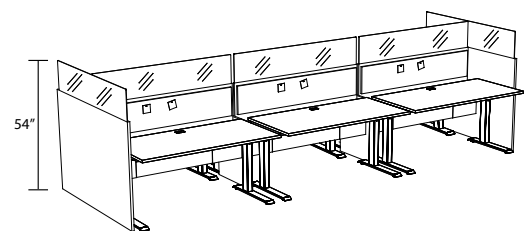
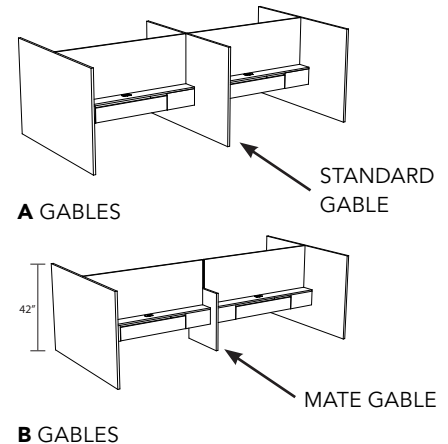

**SHOWN: TEM-3060PW6-B42-PX12**  
WITH **B** GABLES, CALYPSO WITH 60" WIDE  
TOPS & OPTIONAL TACK BOARDS

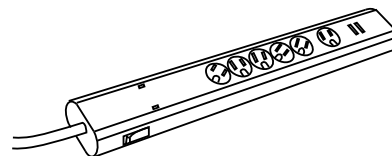

**100-PB6-USB**

# TEAM POWER WALL - 4 POD

| MODEL | LIST | WEIGHT | CUBE | W  | D  | H  |
|-------|------|--------|------|----|----|----|
|       |      |        |      | IN | IN | IN |

**POWER WALL - 4 POD -**  
 42" PANEL HEIGHT OR ADD CHOICE OF 6" (PX6) OR 12" (PX12) PLEXIGLASS EXTENSION  
 48" WIDE WORK STATIONS

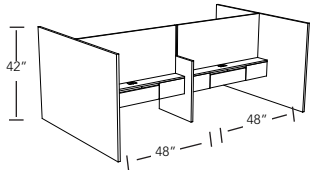

**SHOWN:** TEM-3048PW4-B42

|                      |         |        |       |       |       |    |
|----------------------|---------|--------|-------|-------|-------|----|
| TEM-2448PW4-B42      | \$2,684 | 244.9  | 10.12 | 101.5 | 50.25 | 42 |
| TEM-2448PW4-B42-PX6  | \$3,084 | 254.6  | 10.12 | 101.5 | 50.25 | 48 |
| TEM-2448PW4-B42-PX12 | \$3,394 | 264.4  | 10.12 | 101.5 | 50.25 | 54 |
| TEM-3048PW4-B42      | \$2,761 | 270.3  | 11.6  | 101.5 | 62.25 | 42 |
| TEM-3048PW4-B42-PX6  | \$3,175 | 281.2  | 11.6  | 101.5 | 62.25 | 48 |
| TEM-3048PW4-B42-PX12 | \$3,496 | 292.04 | 11.6  | 101.5 | 62.25 | 54 |

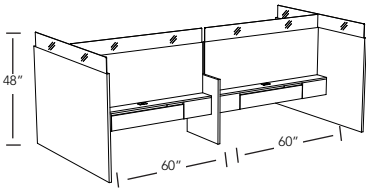

**SHOWN:** TEM-3060PW4-B42-PX6

60" WIDE WORK STATIONS

|                      |         |        |       |     |       |    |
|----------------------|---------|--------|-------|-----|-------|----|
| TEM-2460PW4-B42      | \$2,755 | 271.8  | 11.39 | 125 | 50.25 | 42 |
| TEM-2460PW4-B42-PX6  | \$3,166 | 282.45 | 11.39 | 125 | 50.25 | 48 |
| TEM-2460PW4-B42-PX12 | \$3,486 | 293.2  | 11.39 | 125 | 50.25 | 54 |
| TEM-3060PW4-B42      | \$2,817 | 297.2  | 12.87 | 125 | 62.25 | 42 |
| TEM-3060PW4-B42-PX6  | \$3,238 | 309    | 12.87 | 125 | 62.25 | 48 |
| TEM-3060PW4-B42-PX12 | \$3,566 | 320.9  | 12.87 | 125 | 62.25 | 54 |

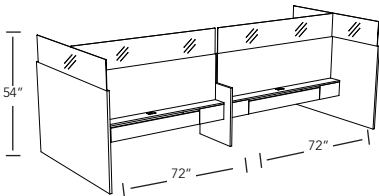

**SHOWN:** TEM-3072PW4-B42-PX12

72" WIDE WORK STATIONS

|                      |         |       |       |        |       |    |
|----------------------|---------|-------|-------|--------|-------|----|
| TEM-2472PW4-B42      | \$2,931 | 299.5 | 12.64 | 148.75 | 50.25 | 42 |
| TEM-2472PW4-B42-PX6  | \$3,368 | 311.3 | 12.64 | 148.75 | 50.25 | 48 |
| TEM-2472PW4-B42-PX12 | \$3,709 | 323.2 | 12.64 | 148.75 | 50.25 | 54 |
| TEM-3072PW4-B42      | \$3,019 | 324.8 | 14.14 | 148.75 | 62.25 | 42 |
| TEM-3072PW4-B42-PX6  | \$3,469 | 337.8 | 14.14 | 148.75 | 62.25 | 48 |
| TEM-3072PW4-B42-PX12 | \$3,820 | 350.8 | 14.14 | 148.75 | 62.25 | 54 |

- ORDER WITH **A** OR **B** GABLE SET - SEE SPECIFICATIONS & DESCRIPTION FOR MORE DETAILS

**NOTE:** WORK STATION SIZE INDICATES THE SIZE OF THE INTENDED DESKING UNIT USED WITH THE POWER WALL. FOR EXAMPLE 72" WORKSTATIONS ARE DESIGNED TO WORK WITH 72" WIDE HEIGHT ADJUSTABLE DESKING UNITS. (HEARTWOOD SIZES EQUAL THE METRIC EQUIVALENT - STANDARD 72" DESK MEASURES 71")

**RTA**

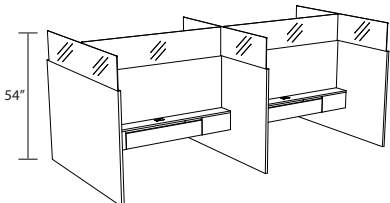

**SHOWN:** TEM-3060PW4-A42-PX12 WITH **A** GABLES

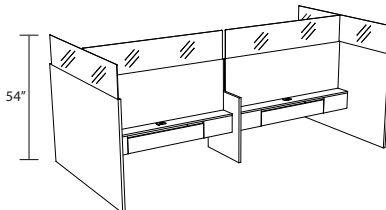

**SHOWN:** TEM-3060PW4-B42-PX12 WITH **B** GABLES

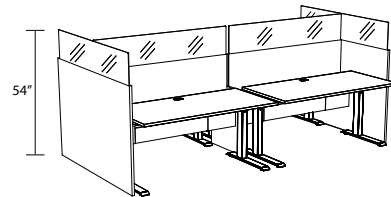

**SHOWN:** TEM-3060PW4-B42-PX12 WITH **B** GABLES & CALYPSO

# TEAM POWER WALL - 4 POD

| MODEL | LIST | WEIGHT | CUBE            | W  | D  | H  |
|-------|------|--------|-----------------|----|----|----|
|       |      | LBS    | FT <sup>3</sup> | IN | IN | IN |

## POWER WALL - 4 POD

54" PANEL HEIGHT OR ADD CHOICE OF 6" (PX6) OR 12" (PX12) PLEXIGLASS EXTENSION

48" WIDE WORK STATIONS

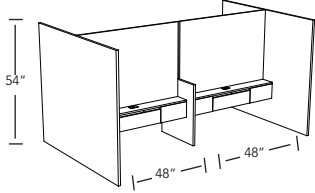

SHOWN: TEM-3048PW4-B54

|                      |         |       |       |       |       |    |
|----------------------|---------|-------|-------|-------|-------|----|
| TEM-2448PW4-B54      | \$3,086 | 244.9 | 10.12 | 101.5 | 50.25 | 54 |
| TEM-2448PW4-B54-PX6  | \$3,546 | 254.6 | 10.12 | 101.5 | 50.25 | 60 |
| TEM-2448PW4-B54-PX12 | \$3,904 | 264.4 | 10.12 | 101.5 | 50.25 | 72 |
| TEM-3048PW4-B54      | \$3,177 | 270.3 | 11.6  | 101.5 | 62.25 | 54 |
| TEM-3048PW4-B54-PX6  | \$3,651 | 281.2 | 11.6  | 101.5 | 62.25 | 60 |
| TEM-3048PW4-B54-PX12 | \$4,023 | 292.1 | 11.6  | 101.5 | 62.25 | 72 |

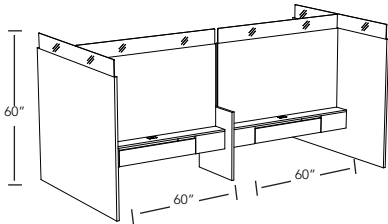

SHOWN: TEM-3060PW4-B54-PX6

60" WIDE WORK STATIONS

|                      |         |       |       |     |       |    |
|----------------------|---------|-------|-------|-----|-------|----|
| TEM-2460PW4-B54      | \$3,167 | 271.8 | 11.39 | 125 | 50.25 | 54 |
| TEM-2460PW4-B54-PX6  | \$3,641 | 282.5 | 11.39 | 125 | 50.25 | 60 |
| TEM-2460PW4-B54-PX12 | \$4,010 | 293.2 | 11.39 | 125 | 50.25 | 72 |
| TEM-3060PW4-B54      | \$3,243 | 297.2 | 12.87 | 125 | 62.25 | 54 |
| TEM-3060PW4-B54-PX6  | \$3,724 | 309   | 12.87 | 125 | 62.25 | 60 |
| TEM-3060PW4-B54-PX12 | \$4,102 | 320.9 | 12.87 | 125 | 62.25 | 72 |

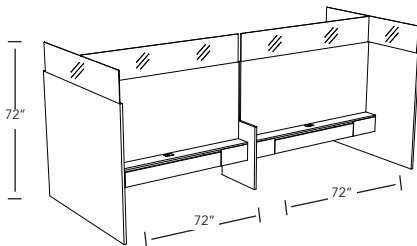

SHOWN: TEM-3072PW4-B54-PX12

72" WIDE WORK STATIONS

|                      |         |       |       |        |       |    |
|----------------------|---------|-------|-------|--------|-------|----|
| TEM-2472PW4-B54      | \$3,370 | 299.5 | 12.64 | 148.75 | 50.25 | 54 |
| TEM-2472PW4-B54-PX6  | \$3,872 | 311.3 | 12.64 | 148.75 | 50.25 | 60 |
| TEM-2472PW4-B54-PX12 | \$4,265 | 323.2 | 12.64 | 148.75 | 50.25 | 72 |
| TEM-3072PW4-B54      | \$3,472 | 324.8 | 14.14 | 148.75 | 62.25 | 54 |
| TEM-3072PW4-B54-PX6  | \$3,990 | 337.8 | 14.14 | 148.75 | 62.25 | 60 |
| TEM-3072PW4-B54-PX12 | \$4,394 | 350.8 | 14.14 | 148.75 | 62.25 | 72 |

- ORDER WITH **A** OR **B** GABLE SET - SEE SPECIFICATIONS & DESCRIPTION FOR MORE DETAILS

**NOTE:** WORK STATION SIZE INDICATES THE SIZE OF THE INTENDED DESKING UNIT USED WITH THE POWER WALL. FOR EXAMPLE 72" WORKSTATIONS ARE DESIGNED TO WORK WITH 72" WIDE HEIGHT ADJUSTABLE DESKING UNITS. (HEARTWOOD SIZES EQUAL THE METRIC EQUIVALENT - STANDARD 72" DESK MEASURES 71")

RTA

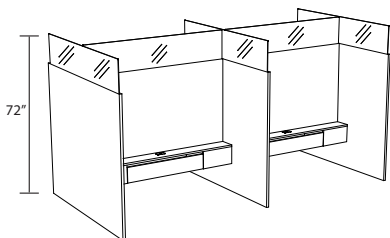

SHOWN: TEM-3060PW4-A54-PX12 WITH **A** GABLES

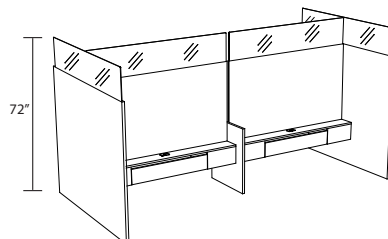

SHOWN: TEM-3060PW4-B54-PX12 WITH **B** GABLES

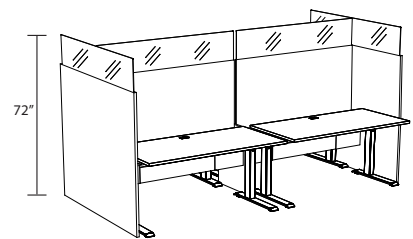

SHOWN: TEM-3060PW4-B54-PX12 WITH **B** GABLES & CALYPSO

# TEAM POWER WALL - 6 POD

| MODEL | LIST | WEIGHT | CUBE | W  | D  | H  |
|-------|------|--------|------|----|----|----|
|       |      |        |      | IN | IN | IN |

### POWER WALL - 6 POD

42" PANEL HEIGHT OR ADD CHOICE OF 6" (PX6) OR 12" (PX12) PLEXIGLASS EXTENSION

48" WIDE WORK STATIONS

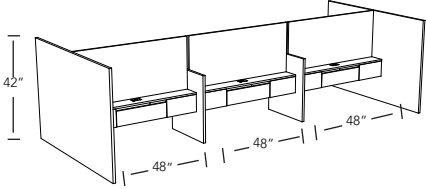

SHOWN: TEM-3048PW6-B42

|                      |         |        |       |        |       |    |
|----------------------|---------|--------|-------|--------|-------|----|
| TEM-2448PW6-B42      | \$3,488 | 320.9  | 13.85 | 151.75 | 50.25 | 42 |
| TEM-2448PW6-B42-PX6  | \$4,008 | 333.1  | 13.85 | 151.75 | 50.25 | 48 |
| TEM-2448PW6-B42-PX12 | \$4,414 | 345.2  | 13.85 | 151.75 | 50.25 | 54 |
| TEM-3048PW6-B42      | \$3,591 | 346.32 | 15.63 | 151.75 | 62.25 | 42 |
| TEM-3048PW6-B42-PX6  | \$4,129 | 359.6  | 15.63 | 151.75 | 62.25 | 48 |
| TEM-3048PW6-B42-PX12 | \$4,546 | 372.8  | 15.63 | 65     | 23.75 | 42 |

60" WIDE WORK STATIONS

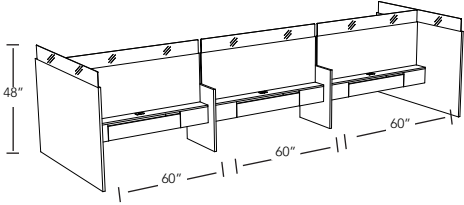

SHOWN: TEM-3060PW4-B42-PX6

|                      |         |       |       |        |       |    |
|----------------------|---------|-------|-------|--------|-------|----|
| TEM-2460PW6-B42      | \$3,582 | 361.2 | 15.75 | 187.25 | 50.25 | 42 |
| TEM-2460PW6-B42-PX6  | \$4,115 | 386.1 | 15.75 | 187.25 | 50.25 | 48 |
| TEM-2460PW6-B42-PX12 | \$4,533 | 388.9 | 15.75 | 187.25 | 50.25 | 54 |
| TEM-3060PW6-B42      | \$3,664 | 386.6 | 17.54 | 187.25 | 62.25 | 42 |
| TEM-3060PW6-B42-PX6  | \$4,210 | 401.4 | 17.54 | 187.25 | 62.25 | 48 |
| TEM-3060PW6-B42-PX12 | \$4,638 | 416.2 | 17.54 | 187.25 | 62.25 | 54 |

72" WIDE WORK STATIONS

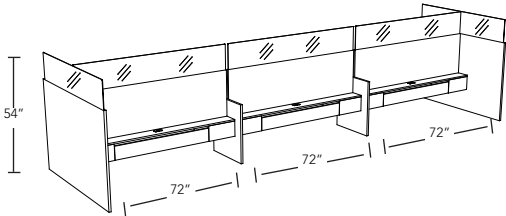

SHOWN: TEM-3072PW6-B42-PX12

|                      |         |       |       |       |       |    |
|----------------------|---------|-------|-------|-------|-------|----|
| TEM-2472PW6-B42      | \$3,810 | 402.7 | 17.66 | 222.5 | 50.25 | 42 |
| TEM-2472PW6-B42-PX6  | \$4,379 | 418.1 | 17.66 | 222.5 | 50.25 | 48 |
| TEM-2472PW6-B42-PX12 | \$4,823 | 433.5 | 17.66 | 222.5 | 50.25 | 54 |
| TEM-3072PW6-B42      | \$3,924 | 428.1 | 19.45 | 222.5 | 62.25 | 42 |
| TEM-3072PW6-B42-PX6  | \$4,509 | 444.6 | 19.45 | 222.5 | 62.25 | 48 |
| TEM-3072PW6-B42-PX12 | \$4,967 | 461.2 | 19.45 | 222.5 | 62.25 | 54 |

- ORDER WITH **A** OR **B** GABLE SET - SEE SPECIFICATIONS & DESCRIPTION FOR MORE DETAILS

**NOTE:** WORK STATION SIZE INDICATES THE SIZE OF THE INTENDED DESKING UNIT USED WITH THE POWER WALL. FOR EXAMPLE 72" WORKSTATIONS ARE DESIGNED TO WORK WITH 72" WIDE HEIGHT ADJUSTABLE DESKING UNITS. (HEARTWOOD SIZES EQUAL THE METRIC EQUIVALENT - STANDARD 72" DESK MEASURES 71").

RTA

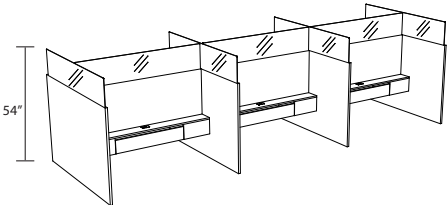

SHOWN: TEM-3060PW6-A42-PX12 WITH **A** GABLES

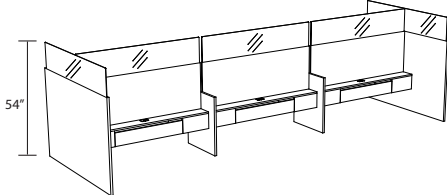

SHOWN: TEM-3060PW6-B42-PX12 WITH **B** GABLES

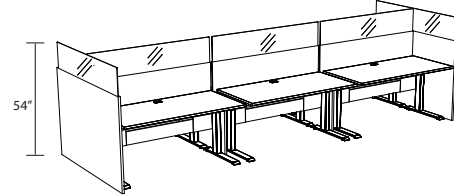

SHOWN: TEM-3060PW6-B42-PX12 WITH **B** GABLES, CALYPSO

# TEAM POWER WALL - 6 POD

| MODEL | LIST | WEIGHT | CUBE            | W  | D  | H  |
|-------|------|--------|-----------------|----|----|----|
|       |      | LBS    | FT <sup>3</sup> | IN | IN | IN |

## POWER WALL - 6 POD

54" PANEL HEIGHT OR ADD CHOICE OF 6" (PX6) OR 12" (PX12) PLEXIGLASS EXTENSION

### 48" WIDE WORK STATIONS

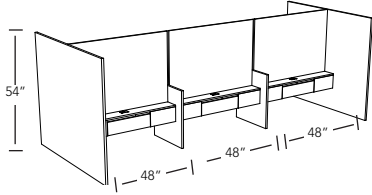

SHOWN: TEM-3048PW6-B54

|                      |         |       |       |        |       |    |
|----------------------|---------|-------|-------|--------|-------|----|
| TEM-2448PW6-B54      | \$4,010 | 320.9 | 13.85 | 151.75 | 50.25 | 54 |
| TEM-2448PW6-B54-PX6  | \$4,608 | 333.1 | 13.85 | 151.75 | 50.25 | 60 |
| TEM-2448PW6-B54-PX12 | \$5,076 | 345.2 | 13.85 | 151.75 | 50.25 | 72 |
| TEM-3048PW6-B54      | \$4,131 | 346.3 | 15.63 | 151.75 | 62.25 | 54 |
| TEM-3048PW6-B54-PX6  | \$4,747 | 359.6 | 15.63 | 151.75 | 62.25 | 60 |
| TEM-3048PW6-B54-PX12 | \$5,228 | 372.8 | 15.63 | 151.75 | 62.25 | 72 |

### 60" WIDE WORK STATIONS

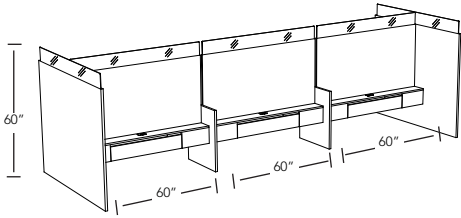

SHOWN: TEM-3060PW4-B54-PX6

|                      |         |       |       |        |       |    |
|----------------------|---------|-------|-------|--------|-------|----|
| TEM-2460PW6-B54      | \$4,117 | 361.2 | 15.75 | 187.25 | 50.25 | 54 |
| TEM-2460PW6-B54-PX6  | \$4,732 | 386.1 | 15.75 | 187.25 | 50.25 | 60 |
| TEM-2460PW6-B54-PX12 | \$5,213 | 388.9 | 15.75 | 187.25 | 50.25 | 72 |
| TEM-3060PW6-B54      | \$4,214 | 386.6 | 17.54 | 187.25 | 62.25 | 54 |
| TEM-3060PW6-B54-PX6  | \$4,842 | 401.4 | 17.54 | 187.25 | 62.25 | 60 |
| TEM-3060PW6-B54-PX12 | \$5,332 | 416.2 | 17.54 | 187.25 | 62.25 | 72 |

### 72" WIDE WORK STATIONS

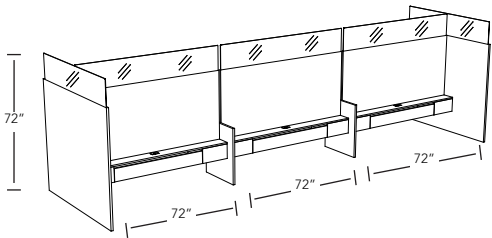

SHOWN: TEM-3072PW6-B54-PX12

|                      |         |       |       |       |       |    |
|----------------------|---------|-------|-------|-------|-------|----|
| TEM-2472PW6-B54      | \$4,382 | 402.7 | 17.66 | 222.5 | 50.25 | 54 |
| TEM-2472PW6-B54-PX6  | \$5,035 | 418.1 | 17.66 | 222.5 | 50.25 | 60 |
| TEM-2472PW6-B54-PX12 | \$5,546 | 433.5 | 17.66 | 222.5 | 50.25 | 72 |
| TEM-3072PW6-B54      | \$4,512 | 428.1 | 19.45 | 222.5 | 62.25 | 54 |
| TEM-3072PW6-B54-PX6  | \$5,187 | 444.6 | 19.45 | 222.5 | 62.25 | 60 |
| TEM-3072PW6-B54-PX12 | \$5,712 | 461.2 | 19.45 | 222.5 | 62.25 | 72 |

- ORDER WITH **A** OR **B** GABLE SET - SEE SPECIFICATIONS & DESCRIPTION FOR MORE DETAILS

**NOTE:** WORK STATION SIZE INDICATES THE SIZE OF THE INTENDED DESKING UNIT USED WITH THE POWER WALL. FOR EXAMPLE 72" WORKSTATIONS ARE DESIGNED TO WORK WITH 72" WIDE HEIGHT ADJUSTABLE DESKING UNITS. (HEARTWOOD SIZES EQUAL THE METRIC EQUIVALENT - STANDARD 72" DESK MEASURES 71")

RTA

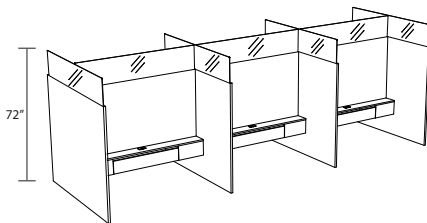

SHOWN: TEM-3060PW6-A54-PX12 WITH **A** GABLES

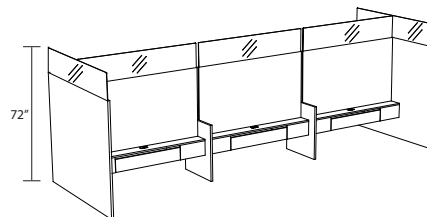

SHOWN: TEM-3060PW6-B54-PX12 WITH **B** GABLES

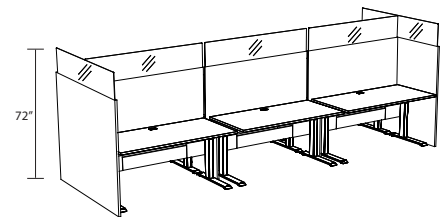

SHOWN: TEM-3060PW6-B54-PX12 WITH **B** GABLES, CALYPSO



# TEAM POWER WALL ACCESSORIES

| MODEL | LIST | WEIGHT | CUBE            | W  | D  | H  |
|-------|------|--------|-----------------|----|----|----|
|       |      | LBS    | FT <sup>3</sup> | IN | IN | IN |

## POWER WALL TACK BOARD

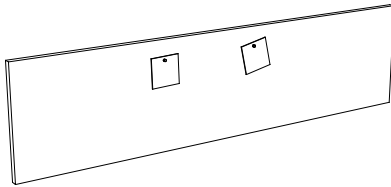

|                |       |      |       |       |     |    |
|----------------|-------|------|-------|-------|-----|----|
| TEM-1248PWS-TB | \$298 | 1.25 | 0.01  | 47.25 | 0.5 | 12 |
| TEM-1260PWS-TB | \$312 | 1.6  | 0.012 | 59.25 | 0.5 | 12 |
| TEM-1272PWS-TB | \$332 | 2    | 0.014 | 71    | 0.5 | 12 |

- EASY INSTALL
- VELCRO ATTACHMENT, PROVIDED
- PRICED AS INDIVIDUAL UNITS. FOR A 4-POD UNIT, ORDER 4 TACKBOARDS IF REQUIRED AT ALL STATIONS.

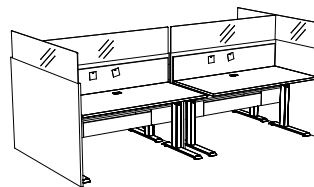

**SHOWN:** TEM-3060PW4-B42-PX12 WITH **B** GABLES, CALYPSO HEIGHT ADJUSTABLE & OPTIONAL TACK BOARDS

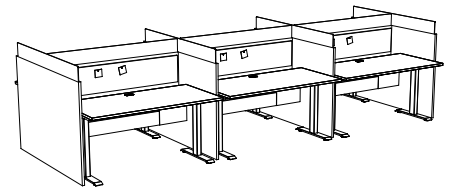

**SHOWN:** TEM-3060PW6-A42-PX6 WITH **A** GABLES, ATHENA HEIGHT ADJUSTABLE & OPTIONAL TACK BOARDS

## POWER BAR WITH USB

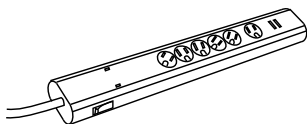

|             |       |      |     |       |      |      |
|-------------|-------|------|-----|-------|------|------|
| 100-PB6-USB | \$157 | 1.93 | .07 | 15.75 | 2.25 | 1.25 |
|-------------|-------|------|-----|-------|------|------|

- RATED FOR 15A @ 120V (1800 WATTS)
- USB CHARGER - 2- 2.1AMP PORTS - 5VDC - 2.1A PER PORT. USB CHARGING ONLY.
- 6 - AC 120V GROUND PLUGS
- 10' POWER CORD WITH 90° PLUG
- 1 UNIT PER 2 POD STATIONS IS RECOMMENDED

AVAILABLE FINISH: BLACK (BL)

## ANGLED DESKTOP POWER GROMMET

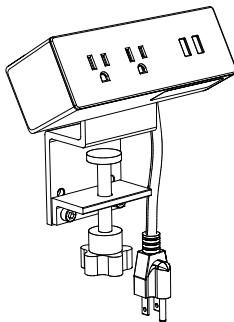

|              |       |   |     |      |      |      |
|--------------|-------|---|-----|------|------|------|
| 100-DTP2-USB | \$332 | 2 | .16 | 6.25 | 3.75 | 3.75 |
|--------------|-------|---|-----|------|------|------|

- USB CHARGER: 5V DC 3.1A (15.5 WATTS), 1.5A PER PORT (7.5 WATTS) RATING: 125V 60HZ 15A
- CHARGING ONLY. 10' 14 AWG X 3C POWER CORD.
- CUL CERTIFIED FOR USE IN CANADA. CAN CLAMP THROUGH OUR RECTANGLE GROMMET (CLAMP WIDTH: 60MM)

AVAILABLE FINISHES: BLACK (BL) & WHITE (WH)

ADD WORKSURFACE POWER GROMMETS IF ADDITIONAL POWER REQUIREMENTS ARE REQUIRED I.E. DATA, **PLEASE SEE 100 SERIES - ACCESSORIES**

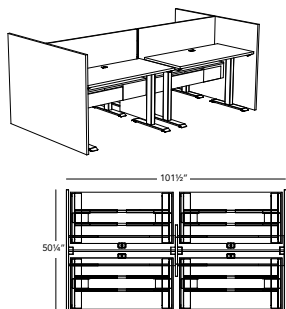

**LAYOUT #1**

|                        |                                 |    |                |
|------------------------|---------------------------------|----|----------------|
| <b>TEM-2448PW4-B42</b> | POWER WALL TEAM STATION - 4 POD |    | <b>\$2,684</b> |
| <b>ATH-E1-2LEG</b>     | ATHENA 2 LEG BASE               | 4X | <b>\$1060</b>  |
| <b>CAL-REC2448</b>     | 24" RECTANGLE TOP               | 4X | <b>\$290</b>   |
| <b>100-PB6-USB</b>     | POWER BAR WITH USB              | 2X | <b>\$157</b>   |
| <b>TOTAL</b>           |                                 |    | <b>\$8,398</b> |

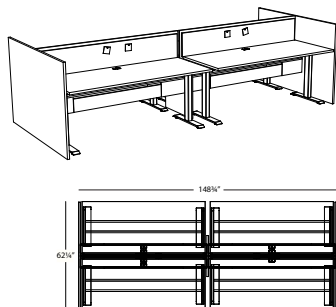

**LAYOUT #2**

|                        |                                 |    |                 |
|------------------------|---------------------------------|----|-----------------|
| <b>TEM-3072PW4-B42</b> | POWER WALL TEAM STATION - 4 POD |    | <b>\$3,019</b>  |
| <b>ATH-E1-2LEG</b>     | ATHENA 2 LEG BASE               | 4X | <b>\$1060</b>   |
| <b>CAL-REC3072</b>     | 30" RECTANGLE TOP               | 4X | <b>\$453</b>    |
| <b>TEM-1272PWS-TB</b>  | 72" POWER WALL TACK BOARD       | 4X | <b>\$332</b>    |
| <b>100-PB6-USB</b>     | POWER BAR WITH USB              | 2X | <b>\$157</b>    |
| <b>TOTAL</b>           |                                 |    | <b>\$10,713</b> |

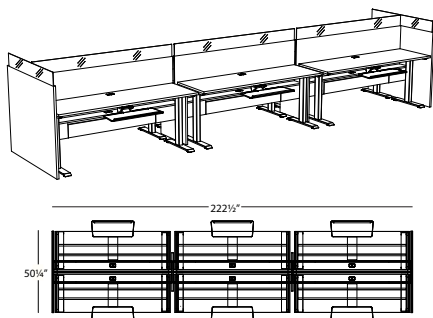

**LAYOUT #3**

|                            |                                 |    |                 |
|----------------------------|---------------------------------|----|-----------------|
| <b>TEM-2472PW6-B42-PX6</b> | POWER WALL TEAM STATION - 6 POD |    | <b>\$4,379</b>  |
| <b>ATH-E1-2LEG</b>         | ATHENA 2 LEG BASE               | 6X | <b>\$1060</b>   |
| <b>CAL-REC2472</b>         | 24" RECTANGLE TOP               | 6X | <b>\$414</b>    |
| <b>100-AKTM-2</b>          | ARTICULATING KEYBOARD TRAY      | 6X | <b>\$275</b>    |
| <b>100-PB6-USB</b>         | POWER BAR WITH USB              | 3X | <b>\$157</b>    |
| <b>TOTAL</b>               |                                 |    | <b>\$15,344</b> |

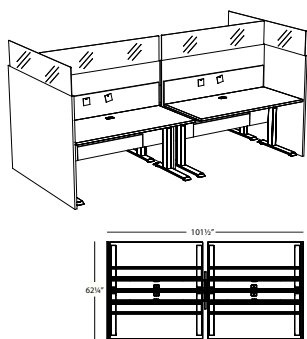

**LAYOUT #4**

|                             |                                 |    |                 |
|-----------------------------|---------------------------------|----|-----------------|
| <b>TEM-3060PW4-B54-PX12</b> | POWER WALL TEAM STATION - 4 POD |    | <b>\$4,102</b>  |
| <b>CAL-E1-2LEG</b>          | CALYPSO 2 LEG BASE              | 4X | <b>\$1,364</b>  |
| <b>CAL-REC3060</b>          | 30" RECTANGLE TOP               | 4X | <b>\$410</b>    |
| <b>TEM-1260PWS-TB</b>       | 60" POWER WALL TACK BOARD       | 4X | <b>\$312</b>    |
| <b>100-PB6-USB</b>          | POWER BAR WITH USB              | 2X | <b>\$157</b>    |
| <b>TOTAL</b>                |                                 |    | <b>\$12,760</b> |

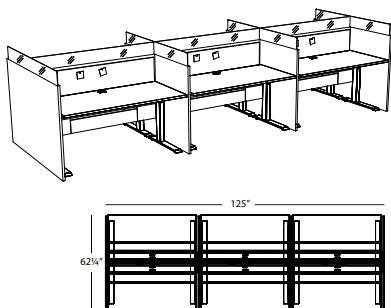

**LAYOUT #5**

|                              |                                 |    |                 |
|------------------------------|---------------------------------|----|-----------------|
| <b>TEM-3060PWS6-A42-PLX6</b> | POWER WALL TEAM STATION - 6 POD |    | <b>\$4,210</b>  |
| <b>CAL-E1-2LEG</b>           | CALYPSO 2 LEG BASE              | 6x | <b>\$1,364</b>  |
| <b>CAL-REC3060</b>           | 30" RECTANGLE TOP               | 6x | <b>\$410</b>    |
| <b>TEM-1260PWS-TB</b>        | 60" POWER WALL TACK BOARD       | 6x | <b>\$312</b>    |
| <b>100-PB6-USB</b>           | POWER BAR WITH USB              | 3x | <b>\$157</b>    |
| <b>TOTAL</b>                 |                                 |    | <b>\$17,197</b> |

Modern, open office configurations are ideally suited to teaming stations and at Heartwood Manufacturing we have made the option as easy as possible. This popular desking design allows for a collaborative, space-saving working environment while maintaining a degree of individual privacy.

**FEATURES**

- ♥ Order as 4 or 6 pod stations
- ♥ Seamlessly & easily add Outlines privacy panels for divided workspaces
- ♥ Designed to work with TEAM Power Line integrated electrical solutions

**CONSTRUCTION**

- ♥ 1" tops
- ♥ All are thermally fused laminate on a 45lb industrial particleboard core.
- ♥ One centre grommet in tops
- ♥ Laminate tops are pre-drilled with metal insert nuts for legs

**LEG OPTIONS**

- ♥ Pre-drilled leg options:  
 900-TAPERLEG  
 900-RL2.5  
 900-SQ3 (default)

**NOTE:** Other leg options from Heartwood do not have a shared metal connecting plate which is required when joining tops together. It is recommended that TEAM Stations use the above legs choices only.

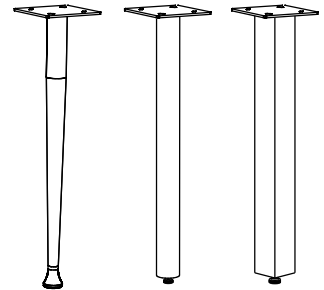

**EDGE DETAIL**

- ♥ Exposed edges all finished in a matching 2mm edge band.
- ♥ Banding changes to an alternate Heartwood standard colour are available at no extra charge.

**ORDERING OUTLINES**

Outlines panels come in a variety of sizes and panel materials and can be configured into numerous layout configurations. When planning Outlines for your pod station, consider the following:

1. panel design on the pod layout
2. configuration of panels
3. panel finishes

♥ **Once the above design features are determined, contact customer service with the complete details for a quote (include overall panel heights, panel combinations and all finishes).**

♥ **When TEAM Stations are ordered with Outlines, worksurfaces are pre-drilled for Outlines posts.**

**PANEL DESIGN:**

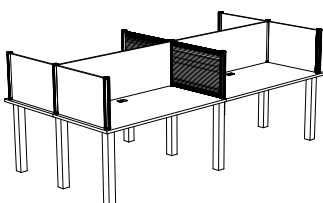

Layout Design 1

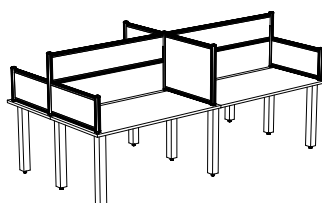

Layout Design 2

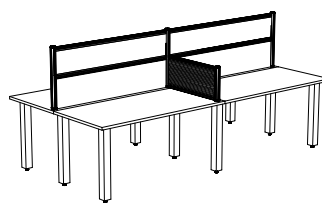

Layout Design 3

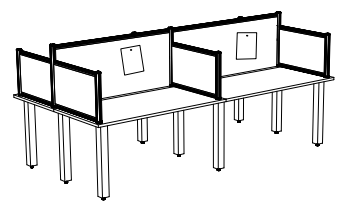

Layout Design 4

PANEL CONFIGURATIONS

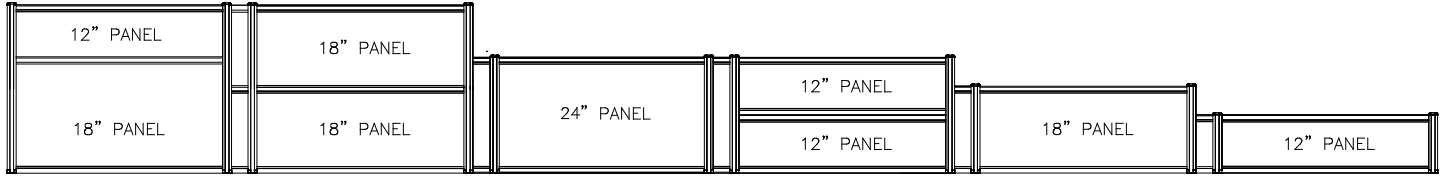

AVAILABLE FINISHES

**Plexiglass (PLX)**, in 3 styles - Clear (CL), Frosted (FR), or Bronze (BR).

**Ribbed Polycarbonate (PYP)**, which allows light to pass through but obscures visibility.

**Laminate (LAM)**, in all standard Heartwood finishes.

**Tack-board (TBP)**, in all standard Heartwood fabrics.

ACCESSORIES

- ♥ Optional accessories - power grommets, power bar, wire management etc. are compatible with this series. See [100 Series - Accessories](#)
- ♥ Designed to work with TEAM Power Line’s system of integrated power receptacles and USB charging. See page [TEM -14](#) for more information.

| MODEL | LIST | WEIGHT | CUBE            | W  | D  | H  |
|-------|------|--------|-----------------|----|----|----|
|       |      | LBS    | FT <sup>3</sup> | IN | IN | IN |

TEAMING STATIONS - 4 POD

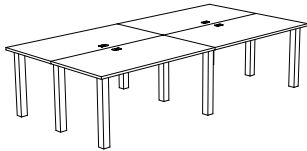

|               |         |        |       |        |       |    |
|---------------|---------|--------|-------|--------|-------|----|
| TEM-REC2448-4 | \$2,516 | 176.4  | 10.68 | 94.5   | 47.25 | 29 |
| TEM-REC2460-4 | \$2,881 | 205.03 | 13.35 | 118.25 | 47.25 | 29 |
| TEM-REC3048-4 | \$2,675 | 202.8  | 13.35 | 94.5   | 59.25 | 29 |
| TEM-REC3060-4 | \$3,067 | 242.5  | 16.69 | 118.25 | 59.25 | 29 |

Add [Outlines](#) privacy panels and [TEAM Power Line](#) integrated power system separately

TEAMING STATIONS - 6 POD

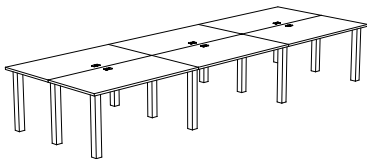

|               |         |       |       |        |       |    |
|---------------|---------|-------|-------|--------|-------|----|
| TEM-REC2448-6 | \$3,549 | 250.2 | 13.98 | 141.75 | 47.25 | 29 |
| TEM-REC2460-6 | \$3,788 | 297.6 | 17.48 | 177.25 | 47.25 | 29 |
| TEM-REC3048-6 | \$3,748 | 308.6 | 17.48 | 141.75 | 59.25 | 29 |
| TEM-REC3060-6 | \$4,089 | 352.7 | 21.85 | 177.25 | 59.25 | 29 |

- TEAMING STATIONS INCLUDE LAMINATE TOPS, METAL LEGS AND STIFFENERS IF APPLICABLE
- LEG SUBSTITUTIONS AVAILABLE AT NO UP-CHARGE
- ALL STANDARD LAMINATE FINISH OPTIONS & METAL LEG FINISH OPTIONS ARE AVAILABLE. PLEASE SEE [HEARTWOOD.CA](#) FOR ALL CURRENT FINISH OPTIONS.
- TEAM STATIONS ARE DESIGNED TO WORK WITH OUTLINES DESKTOP PRIVACY PANELS. PLEASE SEE [OUTLINES SERIES](#) FOR MORE DETAILS OR CONTACT CUSTOMER SERVICE FOR A QUOTE.

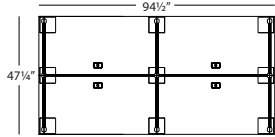
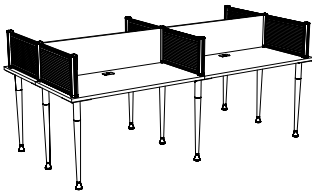

**LAYOUT #1**

|                      |                                  |     |                |
|----------------------|----------------------------------|-----|----------------|
| <b>TEM-REC2448-4</b> | TEAMING STATIONS - 4 POD         |     | <b>\$2,516</b> |
| <b>OUT-12POST</b>    | OUTLINES POST PACKAGE            | 9 X | <b>\$94</b>    |
| <b>OUT-1250TBP</b>   | *CUSTOM 12" TACK BOARD PANEL     | 2 X | <b>\$394</b>   |
| <b>OUT-1226PYP</b>   | *CUSTOM 12" POLYCARBONATE PANELS | 6 X | <b>\$240</b>   |
| <b>TOTAL=</b>        |                                  |     | <b>\$5,590</b> |

**LAYOUT #1 - TEAM POWER LINE**

|                      |                               |     |              |
|----------------------|-------------------------------|-----|--------------|
| <b>TEM-DR</b>        | DUPLEX RECEPTACLE - CIRCUIT 1 | 2 X | <b>\$138</b> |
| <b>TEM-J42L</b>      | 42" LIQUID-TIGHT JUMPER       |     | <b>\$197</b> |
| <b>TEM-72-20AIFL</b> | INFEEED POWER CORDS           |     | <b>\$231</b> |
| <b>TOTAL=</b>        |                               |     | <b>704</b>   |

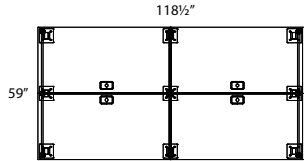
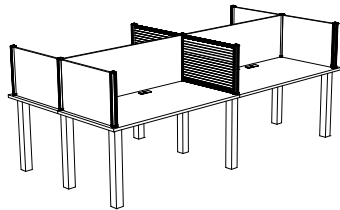

**LAYOUT #2**

|                      |                                 |     |                |
|----------------------|---------------------------------|-----|----------------|
| <b>TEM-REC3060-4</b> | TEAMING STATIONS - 4 POD        |     | <b>\$3,067</b> |
| <b>OUT-18POST</b>    | POST PACKAGES                   | 9 X | <b>\$113</b>   |
| <b>OUT-1832LAP</b>   | *CUSTOM 18" LAMINATE PANEL      | 4 X | <b>\$162</b>   |
| <b>OUT-1862LAP</b>   | *CUSTOM 18" LAMINATE PANEL      | 2 X | <b>\$237</b>   |
| <b>OUT-1832PYP</b>   | *CUSTOM 18" POLYCARBONATE PANEL | 2 X | <b>\$317</b>   |
| <b>TOTAL=</b>        |                                 |     | <b>\$5,840</b> |

**LAYOUT #2 - TEAM POWER LINE ELECTRICAL**

|                       |                               |     |                |
|-----------------------|-------------------------------|-----|----------------|
| <b>TEM-DR</b>         | DUPLEX RECEPTACLE - CIRCUIT 1 | 2 X | <b>\$138</b>   |
| <b>TEM-J54L</b>       | 54" LIQUID-TIGHT JUMPER       | 2 X | <b>\$197</b>   |
| <b>TEM-J30L</b>       | 30" LIQUID-TIGHT JUMPER       |     | <b>\$197</b>   |
| <b>TEM-240-20AIFL</b> | 20AMP 240" INFEEED            |     | <b>\$463</b>   |
| <b>TOTAL=</b>         |                               |     | <b>\$1,330</b> |

NOTE: 6' POWER INFEEED ALSO AVAILABLE

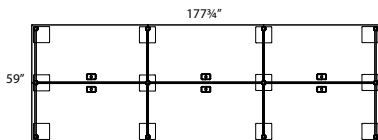
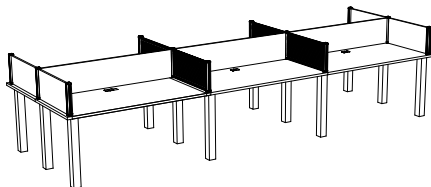

**LAYOUT #3**

|                      |                                  |      |                |
|----------------------|----------------------------------|------|----------------|
| <b>TEM-REC3060-6</b> | TEAMING STATIONS - 6 POD         |      | <b>\$4,089</b> |
| <b>OUT-12POST</b>    | OUTLINES POST PACKAGE            | 12 X | <b>\$94</b>    |
| <b>OUT-1232TBP</b>   | *CUSTOM 12" TACK BOARD PANEL     | 4 X  | <b>\$298</b>   |
| <b>OUT-1232PYP</b>   | *CUSTOM 12" POLYCARBONATE PANELS | 4 X  | <b>\$278</b>   |
| <b>OUT-1262TBP</b>   | *CUSTOM 12" TACK BOARD PANEL     | 2 X  | <b>\$431</b>   |
| <b>OUT-1264TBP</b>   | *CUSTOM 12" TACK BOARD PANEL     |      | <b>\$448</b>   |
| <b>TOTAL=</b>        |                                  |      | <b>\$8,831</b> |

**LAYOUT #3 - TEAM POWER LINE ELECTRICAL**

|                      |                               |     |                |
|----------------------|-------------------------------|-----|----------------|
| <b>TEM-DR</b>        | DUPLEX RECEPTACLE - CIRCUIT 1 | 3 X | <b>\$138</b>   |
| <b>TEM-USBR</b>      | 2 USB CHARGING RECEPTACLEM    | 6 X | <b>\$318</b>   |
| <b>TEM-DR2</b>       | DUPLEX RECEPTACLE - CIRCUIT 2 | 3 X | <b>\$138</b>   |
| <b>TEM-DRC</b>       | DUPLEX RECEPTACLE CONNECTOR   | 6 X | <b>\$45</b>    |
| <b>TEM-J48L</b>      | 48" LIQUID-TIGHT JUMPER       | 4 X | <b>\$197</b>   |
| <b>TEM-J30L</b>      | 30" LIQUID-TIGHT JUMPER       |     | <b>\$197</b>   |
| <b>TEM-72-20AIFL</b> | 20AMP 72" INFEEED             |     | <b>\$231</b>   |
| <b>TOTAL=</b>        |                               |     | <b>\$4,222</b> |

see **TEAM Power Line** for more details

## FEATURES

- ♥ Daisy chain power with multiple stations. Best used in benching or training room applications where multiple stations require power
- ♥ Power jumper cables are liquid-tight are hidden and attach underneath the work surface, mounting hardware included
- ♥ For power requirements other than duplex receptacles and USB, add a Heartwood work surface power grommet. For complete power grommet options see [100 Series - Accessories](#)
- ♥ Heartwood will quote all stations to ensure appropriate electrical is ordered. Submit layout drawings to [cs@heartwood.ca](mailto:cs@heartwood.ca) for a quote with desired electrical requirements per station.  
**For example:** Power, Data and USB per station

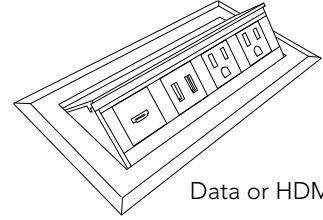

Data or HDMI Options

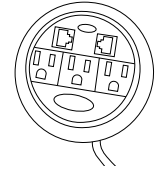

## ELECTRICAL SPECIFICATIONS

- ♥ Team Power Line electrical components are CSA/UL Certified
- ♥ Rated for 20 Amps per circuit allowing the use of two circuits (circuit 1 and 2 only).
- ♥ The conductors are 12 AWG with two-line conductors sharing a neutral and a ground
- ♥ Can be wired in both single and three-phase configurations, 240/120V, 208/120V respectively.
- ♥ Can connect up to 13 duplex receptacles per circuit, or a maximum of 26 (15 A) duplex receptacles per power infeed.
- ♥ The actual number of receptacles recommended on a circuit or infeed will vary depending on load requirements.
- ♥ **WIRING REQUIRES PROFESSIONAL ELECTRICAL INSTALLATION (hardwired)**

## TIPS



- ♥ Jumpers are sized 6" narrower than top size as we account for duplex receptacles.  
**For example:** 60" wide tops received 54" jumpers
- ♥ Duplex receptacles are centered on tops
- ♥ For customized grommet locations email Customer Service

## ACCESSORIES

- ♥ Designed to work with TEAM Stations see [TEM -11](#)
- ♥ Optional accessories - power grommets, power bar, wire management etc. are compatible with this series. See [100 Series - Accessories](#)

## WARRANTY

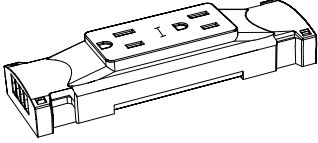
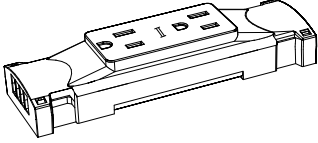
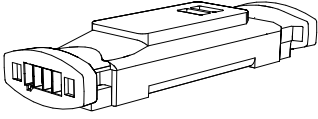
- ♥ 1-year warranty

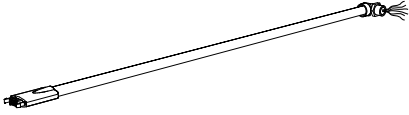
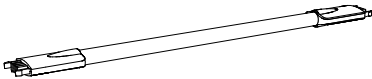
| MODEL   | LIST  |
|---|---|
| <b>DUPLEX RECEPTACLES</b>   |   |
| <b>DUPLEX RECEPTACLE - CIRCUIT 1</b>  |   |
| <ul style="list-style-type: none"> <li>• MAXIMUM OF 13 DUPLEX RECEPTACLES PER CIRCUIT</li> </ul>  |   |
|                  | <b>TEM-DR \$138</b>                           |
| AVAILABLE FINISH: BLACK (BL)  |   |
| <b>DUPLEX RECEPTACLE - CIRCUIT 2</b>  |   |
| <ul style="list-style-type: none"> <li>• MAXIMUM OF 13 DUPLEX RECEPTACLES PER CIRCUIT</li> </ul>  |   |
|                  | <b>TEM-DR2 \$138</b>                          |
| AVAILABLE FINISH: BLACK (BL)  |   |
| <b>2 USB CHARGING RECEPTACLE</b>  |   |
| <ul style="list-style-type: none"> <li>• 2.1 AMPS PER CHARGE PORT. CHARGING ONLY</li> </ul>       |   |
|                  | <b>TEM-USBR \$318</b>                         |
| AVAILABLE FINISH: BLACK (BL)  |   |
| <b>DUPLEX RECEPTACLE CONNECTOR</b>  |   |
| <ul style="list-style-type: none"> <li>• REQUIRED TO CONNECT RECEPTACLES</li> </ul>               |   |
|                  | <b>TEM-DRC \$45</b>                           |
| AVAILABLE FINISH: BLACK (BL)  |   |
| <b>INFEEED POWER CORDS</b>  |   |
| <ul style="list-style-type: none"> <li>• REQUIRES PROFESSIONAL ELECTRICAL INSTALLATION</li> </ul> |   |
| <b>20AMP 72" INFEEED</b>  |   |
|                | <b>TEM-72-20AIFL \$231</b>                    |
| <b>20AMP 240" INFEEED</b>   |   |
|   | <b>TEM-240-20AIFL \$463</b>                   |
| AVAILABLE FINISH: BLACK (BL)  |   |
| <b>ELECTRICAL JUMPER</b>  |   |
|   | <b>TEM-J30L \$197</b> 30" LIQUID-TIGHT JUMPER |
|   | <b>TEM-J36L \$197</b> 36" LIQUID-TIGHT JUMPER |
|   | <b>TEM-J42L \$197</b> 42" LIQUID-TIGHT JUMPER |
|   | <b>TEM-J48L \$197</b> 48" LIQUID-TIGHT JUMPER |
|   | <b>TEM-J54L \$197</b> 54" LIQUID-TIGHT JUMPER |
|   | <b>TEM-J60L \$240</b> 60" LIQUID-TIGHT JUMPER |
|   | <b>TEM-J66L \$240</b> 66" LIQUID-TIGHT JUMPER |
|   | <b>TEM-J72L \$240</b> 72" LIQUID-TIGHT JUMPER |
|   | <b>TEM-J78L \$280</b> 78" LIQUID-TIGHT JUMPER |
|   | <b>TEM-J84L \$280</b> 84" LIQUID-TIGHT JUMPER |
|   | <b>TEM-J90L \$280</b> 90" LIQUID-TIGHT JUMPER |
|                |   |
| <ul style="list-style-type: none"> <li>• JUMPERS ARE SIZED TO MATCH TOP WIDTHS</li> </ul>         |   |
| AVAILABLE FINISH: BLACK (BL)  |   |

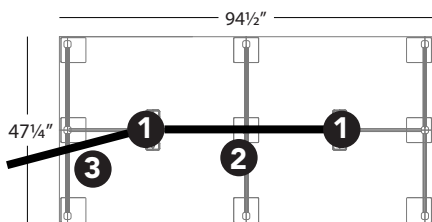

**LAYOUT #1 - TEAM POWER LINE ELECTRICAL ONLY**

|               |                      |                               |     |              |
|---------------|----------------------|-------------------------------|-----|--------------|
| <b>1</b>      | <b>TEM-DR</b>        | DUPLEX RECEPTACLE - CIRCUIT 1 | 2 X | <b>\$138</b> |
| <b>2</b>      | <b>TEM-J42L</b>      | 42" LIQUID-TIGHT JUMPER       |     | <b>\$197</b> |
| <b>3</b>      | <b>TEM-72-20AIFL</b> | INFEED POWER CORDS            |     | <b>\$231</b> |
| <b>TOTAL=</b> |                      |                               |     | <b>\$704</b> |

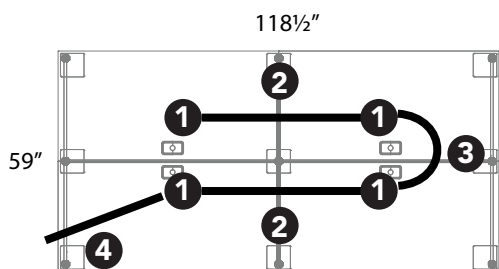
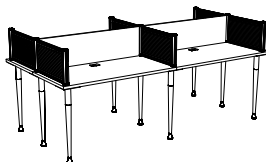

**LAYOUT #2 - TEAM POWER LINE ELECTRICAL ONLY**

|               |                       |                               |     |                |
|---------------|-----------------------|-------------------------------|-----|----------------|
| <b>1</b>      | <b>TEM-DR</b>         | DUPLEX RECEPTACLE - CIRCUIT 1 | 4 X | <b>\$138</b>   |
| <b>2</b>      | <b>TEM-J54L</b>       | 54" LIQUID-TIGHT JUMPER       | 2 X | <b>\$197</b>   |
| <b>3</b>      | <b>TEM-J30L</b>       | 30" LIQUID-TIGHT JUMPER       |     | <b>\$197</b>   |
| <b>4</b>      | <b>TEM-240-20AIFL</b> | 20AMP 240" INFEED             |     | <b>\$463</b>   |
| <b>TOTAL=</b> |                       |                               |     | <b>\$1,606</b> |

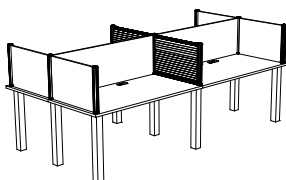

**LAYOUT #3 - TEAM POWER LINE ELECTRICAL ONLY**

|               |                      |                               |     |                |
|---------------|----------------------|-------------------------------|-----|----------------|
| <b>1</b>      | <b>TEM-DR</b>        | DUPLEX RECEPTACLE - CIRCUIT 1 | 3 X | <b>\$138</b>   |
| <b>2</b>      | <b>TEM-USBR</b>      | 2 USB CHARGING RECEPTACLE     | 6 X | <b>\$318</b>   |
| <b>3</b>      | <b>TEM-DR2</b>       | DUPLEX RECEPTACLE - CIRCUIT 2 | 3 X | <b>\$138</b>   |
| <b>4</b>      | <b>TEM-DRC</b>       | DUPLEX RECEPTACLE CONNECTOR   | 6 X | <b>\$45</b>    |
| <b>5</b>      | <b>TEM-J48L</b>      | 48" LIQUID-TIGHT JUMPER       | 4 X | <b>\$197</b>   |
| <b>6</b>      | <b>TEM-J30L</b>      | 30" LIQUID-TIGHT JUMPER       |     | <b>\$197</b>   |
| <b>7</b>      | <b>TEM-72-20AIFL</b> | 20AMP 72" INFEED              |     | <b>\$231</b>   |
| <b>TOTAL=</b> |                      |                               |     | <b>\$4,222</b> |

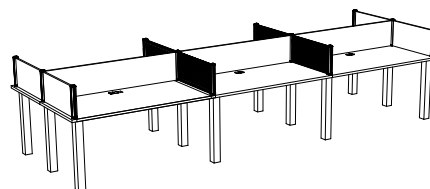
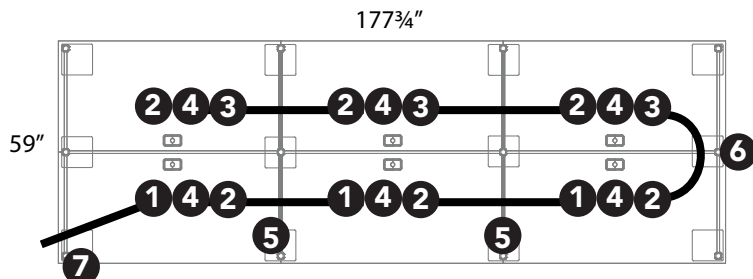



## FEATURES

- ♥ Individual laminate pods gang together to form study carrel unit, indicate on PO the number of pods required per unit. See **ORDER DETAILS** for examples.
- ♥ Three convenient sizes, customization is available
- ♥ Optional fixed-top self available
- ♥ Two-tone combinations are available at no extra charge.
- ♥ Ships in multiple cartons – **RTA**

## CONSTRUCTION

- ♥ All backs are ¾" height. ½ or full height backs are available at no extra charge on most units.  
For ½ height back add **2** to the Sku:  
> **Ordering Example:** TEM-2448GSC-48-**2**  
For full height back remove **3** from the Sku:  
> **Ordering Example:** TEM-2448GSC-**48**
- ♥ All other parts are 1"
- ♥ All are thermally fused laminate on a 45lb industrial particle board core.
- ♥ Leveling glides are standard on all floor models.
- ♥ Includes grommet

## EDGE DETAIL

- ♥ Exposed edges all finished in a matching 2mm edge band
- ♥ Banding changes to an alternate Heartwood standard colour are available at no extra charge.

## OPTIONS

- ♥ Optional fixed top shelf. 10" deep  
To order fixed shelf add **S** to end of the Sku:  
> **Ordering Example:** TEM-2448GSC-48-**3S**  
If optional shelf is selected, all pods ordered in the study carrel unit will receive the shelf unless otherwise indicated. **\$128** up-charge applies.

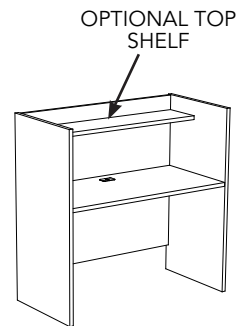

## ACCESSORIES

- ♥ Optional power grommets, power bar, wire management and numerous other accessories are available to work with this series.  
See [100 Series - Accessories](#)

## ORDER DETAILS

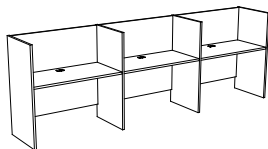

**Order Example:**  
**1 unit with 3 pods**  
**3 x** TEM-2448GSC-48-3

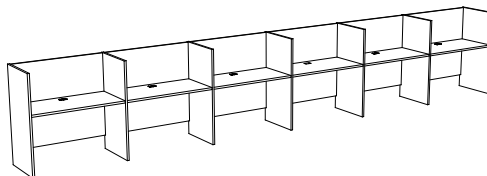

**Order Example:**  
**1 unit with 6 pods**  
**6 x** TEM-2448GSC-48-3

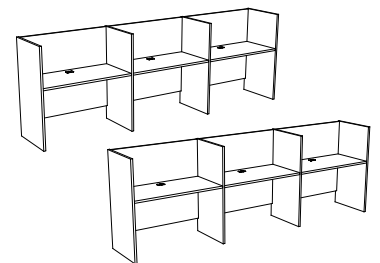

**Order Example:**  
**2 units with 3 pods each**  
**Qty 2 - 3 x** TEM-2448GSC-48-3

# TEAM STUDY CARRELS

| MODEL | LIST | WEIGHT | CUBE            | W  | D  | H  |
|-------|------|--------|-----------------|----|----|----|
|       |      | LBS    | FT <sup>3</sup> | IN | IN | IN |

## STUDY CARRELS

36" WIDE GANGED STUDY CARREL W/ ¾ HEIGHT BACK

|                  |         |       |     |      |       |    |
|------------------|---------|-------|-----|------|-------|----|
| TEM-2436GSC-48-3 | \$1,038 | 110.2 | 4.4 | 35.5 | 23.75 | 48 |
|------------------|---------|-------|-----|------|-------|----|

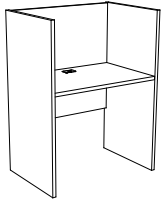

TEM-2436GSC-48-2

42" WIDE GANGED STUDY CARREL W/ ¾ HEIGHT BACK

|                  |         |       |     |      |       |    |
|------------------|---------|-------|-----|------|-------|----|
| TEM-2442GSC-48-3 | \$1,093 | 119.0 | 5.1 | 41.5 | 23.75 | 48 |
|------------------|---------|-------|-----|------|-------|----|

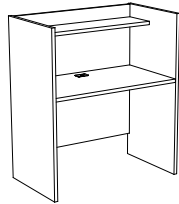

TEM-2442GSC-48-3S

48" WIDE GANGED STUDY CARREL W/ ¾ HEIGHT BACK

|                  |         |       |      |       |       |    |
|------------------|---------|-------|------|-------|-------|----|
| TEM-2448GSC-48-3 | \$1,158 | 127.9 | 5.79 | 47.25 | 23.75 | 48 |
|------------------|---------|-------|------|-------|-------|----|

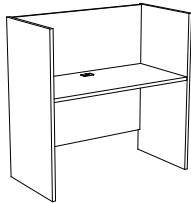

TEM-2448GSC-48-3

- ADD **-2** FOR ½ HEIGHT BACK OR REMOVE **-3** FOR A FULL HEIGHT BACK DEFAULT IS ¾ HEIGHT
- INCLUDES GROMMET
- ADD **\$** AT END OF THE SKU FOR AN OPTIONAL SHELF (**\$128** LIST PER SHELF)
- AVAILABLE IN ALL CURRENT HEARTWOOD LAMINATE FINISHES. SEE [HEARTWOOD.CA](https://heartwood.ca) FOR FINISH OPTIONS
- FOR 30" DEEP STUDY CARREL UNITS, ADD **\$126** LIST UP-CHARGE AND CHANGE THE SKU FROM 24 TO 30  
EXAMPLE: TEM-**2442**GSC-48-3 BECOMES TEM-**3042**GSC-48-3 - **\$1,219**

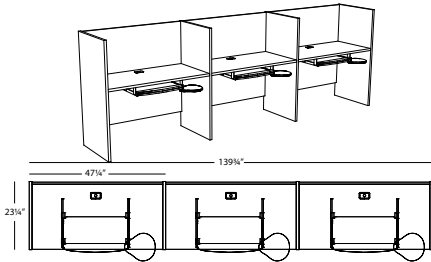

**LAYOUT #1**

|                         |   |    |                |
|-------------------------|---|----|----------------|
| <b>TEM-2448GSC-48-3</b> | 48" WIDE GANGED STUDY CARREL W/ ¾ HEIGHT BACK | 3X | <b>\$1,158</b> |
| <b>100-KTM</b>          | KEYBOARD TRAY                                 | 3X | <b>\$169</b>   |
| TOTAL                   |   |    | <b>\$3,981</b> |

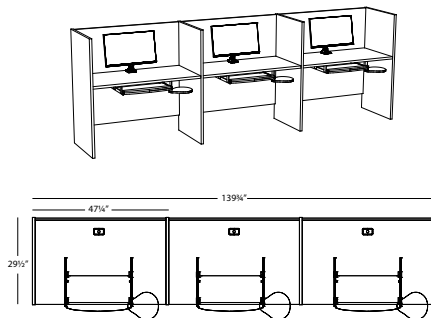

**LAYOUT #2**

|                         |  |    |                |
|-------------------------|--|----|----------------|
| <b>TEM-3048GSC-48-3</b> | 48" WIDE GANGED STUDY CARREL W/ ¾ HEIGHT BACK - 30" DEEP | 3X | <b>\$1,284</b> |
| <b>100-KTM</b>          | KEYBOARD TRAY  | 3X | <b>\$169</b>   |
| <b>100-MA1</b>          | PNEUMATIC LCD SINGLE MONITOR ARM                         | 3X | <b>\$306</b>   |
| TOTAL                   |  |    | <b>\$5,277</b> |

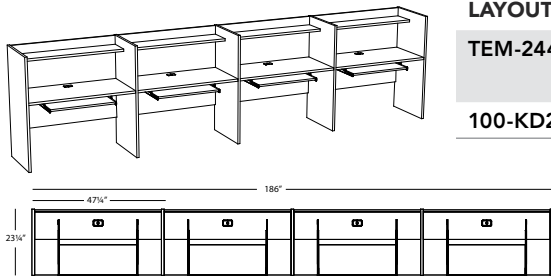

**LAYOUT #3**

|                          |   |    |                |
|--------------------------|---|----|----------------|
| <b>TEM-2448GSC-48-2S</b> | 48" WIDE GANGED STUDY CARREL W/ ¾ HEIGHT BACK | 4X | <b>\$1,158</b> |
|                          | OPTIONAL SHELF UPCHARGE                       | 4X | <b>\$128</b>   |
| <b>100-KD28</b>          | KEYBOARD DRAWER                               | 4X | <b>\$202</b>   |
| TOTAL                    |   |    | <b>\$5,952</b> |

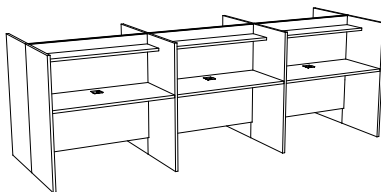

**LAYOUT #4**

|                          |   |            |                |
|--------------------------|---|------------|----------------|
| <b>TEM-2448GSC-48-3S</b> | 48" WIDE GANGED STUDY CARREL W/ ¾ HEIGHT BACK | QTY 2 - 3X | <b>\$1,158</b> |
|                          | OPTIONAL SHELF UPCHARGE                       | QTY 2 - 3X | <b>\$128</b>   |
| TOTAL                    |   |            | <b>\$7,716</b> |

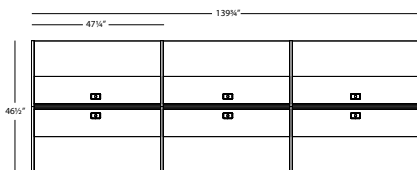

NOTES:

---

## Conditions of Sale

### Prices

Prices are subject to change without notice.

### Terms

Merchandise will be invoiced when shipped and payment is due 30 days after invoice date. All applicable taxes are extra. All shipments are F.O.B. Heartwood Manufacturing, unless otherwise indicated. 2% interest per month will be charged on all overdue accounts.

### Orders

All orders are subject to acceptance by Heartwood and to the terms of sale specified on current price lists. Verbal or telephone orders can only be processed upon receipt of written or faxed confirmation.

### Shipping

All shipments will be sent "best way" unless carrier specified by customer.

### Cancellations

All orders are considered firm and not subject to cancellation without prior written approval. Cancellation charges may be required based on expenses incurred during order processing.

### Changes

Heartwood Manufacturing reserves the right to make improvements and changes to design, material and packaging and to discontinue models at any time without prior notice.

### Storage

Storage charges may be assessed on all items not accepted by customer within one week of scheduled delivery date. Invoices for merchandise will be dated and issued at the time merchandise is ready for delivery.

### Specifications

Dimensions in inches and all shipping weights indicated are approximate.

## Limited Lifetime Warranty - Laminate Office Furniture

Heartwood Manufacturing Ltd. (HML), wishes to assure dealers and customers who purchase our products that they are investing in the best quality furniture available in its class. To this end, any laminate furniture products produced by HML on or after February 1st, 2012 are warranted to be free from defects in materials and workmanship for as long as the original purchaser owns the product. Please refer to our "Limited Lifetime Warranty" document for exceptions. In the unlikely event that any product or component covered by this warranty should fail under normal workplace conditions, as described and limited in this document, HML promises to repair it. If we are unable to repair it, we will replace it with comparable product.

This warranty is limited to manufacturer's defects and will not apply to any products that must be repaired or replaced due to normal wear and tear, negligence, abuse or installation errors. Products that have been modified or altered by others or used for rental purposes are not covered. This warranty covers materials only, labour and shipping costs for repair or replacement are not covered.

Heartwood Manufacturing Ltd. reserves the right to change laminate, fabric and hardware suppliers and, as a result, we do not guarantee the match of colours, grain or hardware to those of existing products.

This warranty, as explained here, is your sole and exclusive remedy. To make a warranty claim, proof of purchase must be presented. Please refer to our Warranty Process document to be certain you have provided all of the information we require to ensure an accurate and speedy resolution.

**Contact Customer Service if you have questions at 1-800-567-3060 or email [cs@heartwood.ca](mailto:cs@heartwood.ca) to make a claim.**

## PREPAID FREIGHT – DAMAGE CLAIMS

### Visible Damage Upon Receipt

1. Inspect each shipment upon receipt. If any external evidence of loss or damage is visible, please note on the freight proof of delivery (ie) DAMAGED CARTON. Failure to adequately describe such external evidence of loss or damage may result in the carrier refusing to honor a damage claim. Please do not refuse damaged freight. This will result in delays in the replacement of the damaged products.
2. All Damaged Items (salvage) must also be stored at the consignee location for the carrier's investigation process. Disposing of salvage will also result in the carrier refusing to honor a damage claim. Domestic freight claim investigations may take from 90 - 120 days.
3. Advise Customer Service within 14 days upon receipt to initiate the warranty replacement and the freight claim processes. A copy of the freight proof of delivery, reference to order #, item(s) missing or damaged, and pictures will be advantageous when submitting a claim.

### Concealed Loss Or Damage

Concealed loss or damage is loss or damage that does not become apparent until the merchandise has been unpacked.

1. When loss is discovered upon unpacking - immediately make a written request via email to Customer Service. Communicate any concealed loss within 1-2 days of receipt. An immediate inspection by the carrier will be requested and a freight claim will be initiated.
2. When concealed damage is discovered upon unpacking, immediately make a written request via email to Customer Service. Include the necessary photos and warranty label information to ensure a quick resolution. See our "Warranty Process" document for example photos.

PLEASE NOTE THAT FREIGHT DAMAGE CLAIMS AND CONCEALED DAMAGE CLAIMS ARE NOT ACCEPTED WHEN DAMAGE IS TO THE CARTON ONLY.

If these instructions are followed carefully and complete, we guarantee full support of your claims to protect you against loss from concealed damage.

**Failure to store salvage items until the Claim Investigation is complete (90-120 days), will result in the carrier refusing to honor the claim.**

**Freight claims denied for the reasons of "NO SALVAGE AVAILABLE" will be invoiced back to the customer along with any ancillary freight Charges incurred.**