



hush.  
*acoustics*

# hush.

Noise is unwanted sound; considered to be unpleasant, loud or disruptive. Acoustics is the science of sound and it is here that MityBilt HUSH succeeds in providing acoustically pleasant environments using new generation acoustic materials and cutting edge technology.

HUSH is about providing pleasant learning, working and living spaces by overcoming the negative health effects of noise and adding design rich solutions. HUSH operates in a new era, developing acoustic solutions by using lifecycle products, which can be used again and again. We firmly believe PET-Technology is one of the answers to ecological sustainability and environmental quality products for contemporary interior design.

## P.E.T. Acoustic Felt

P.E.T. (v) is a form of polyester, it is an energy-efficient material that enjoys a very favorable sustainability profile in comparison to other design favoured products including some recyclable materials such as aluminum and glass. In the 60 years since P.E.T. was first synthesized. It has become one of the world's most widely used, versatile and trusted materials.

The high strength of P.E.T. in comparison to its light weight is a major key to its energy efficiency. Ongoing advances in light-weight technology continue to improve its energy efficiency even further. Life cycle of studies of PET have consistently confirmed the environmental benefits of PET. Hush panels are made from 100% P.E.T. fiber of which +/- 60% is derived from recycled plastic water bottles. The production of Hush is very eco-friendly resulting in low energy use, no emissions, no off gassing or VOC's, and no waste water. The manufacture of P.E.T. panels does not require the use of any adhesives.



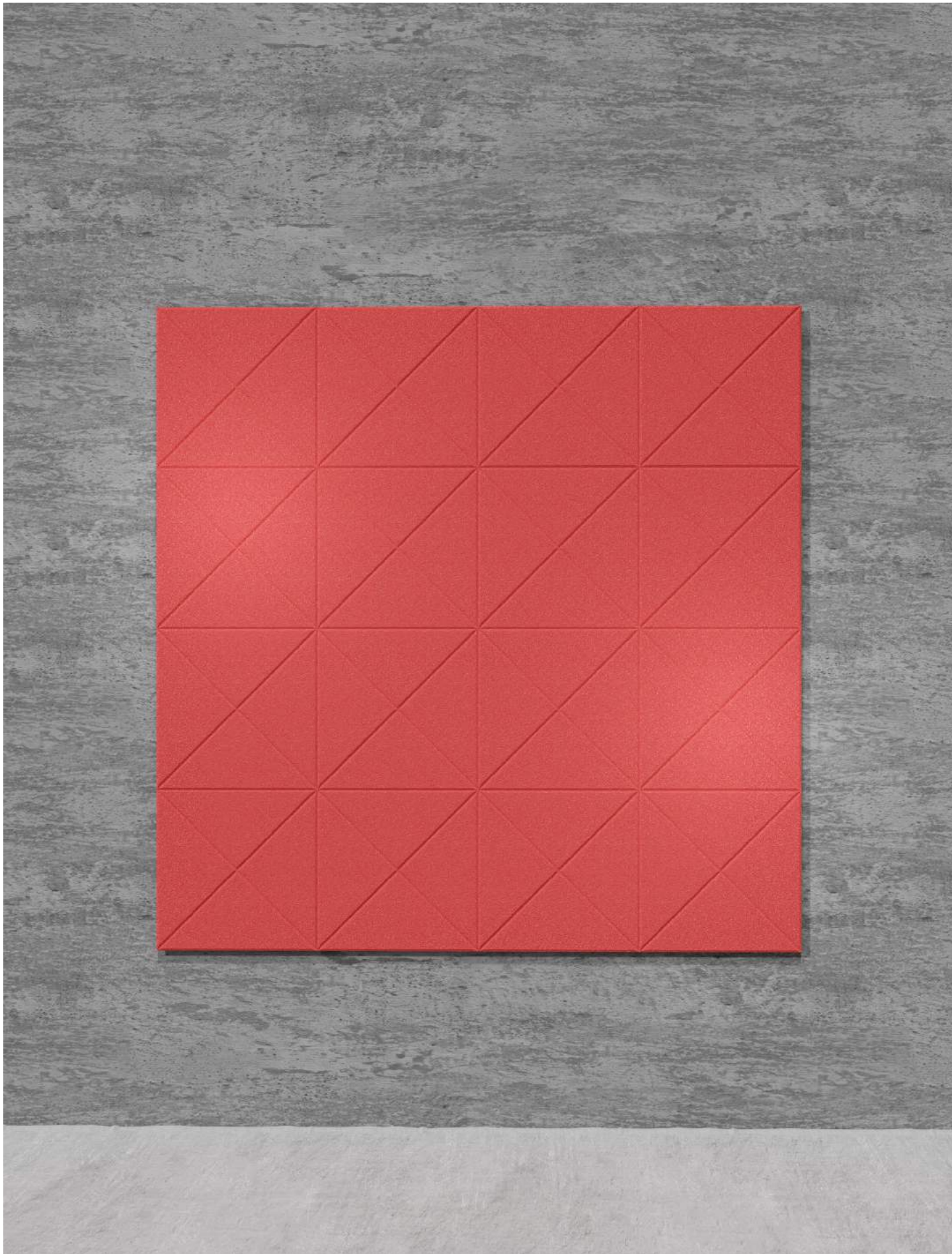

# hush. wall tiles

etch - 1

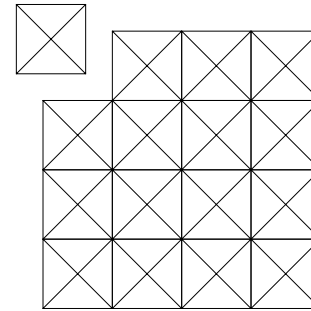

etch - 2

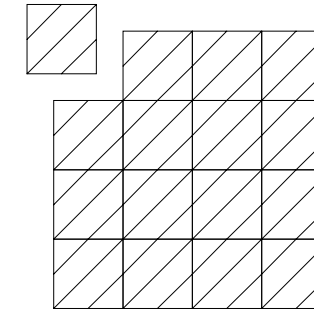

etch - 3

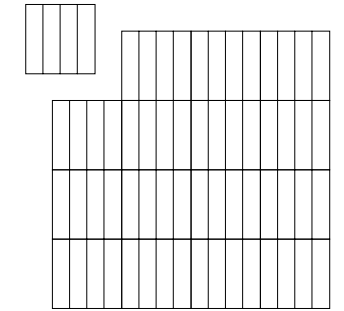

etch - 4

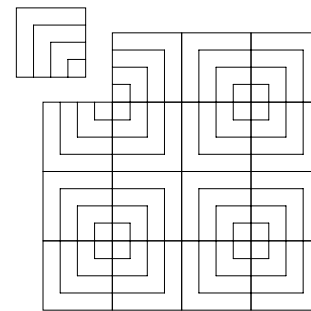

etch - 5

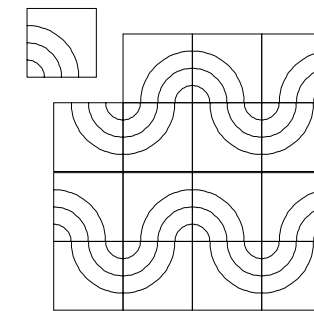

etch - 6

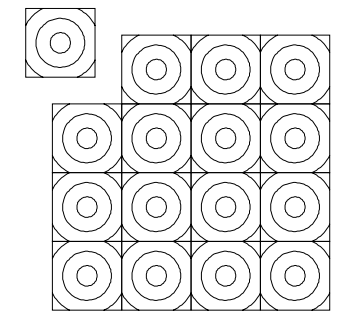

etch - 7

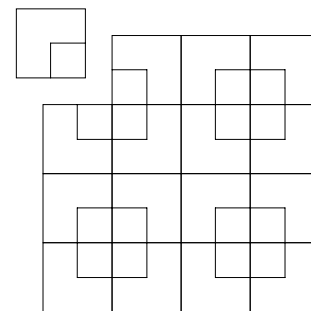

etch - 8

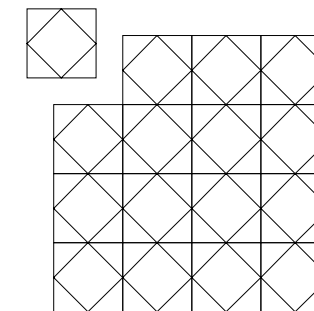

etch - 9

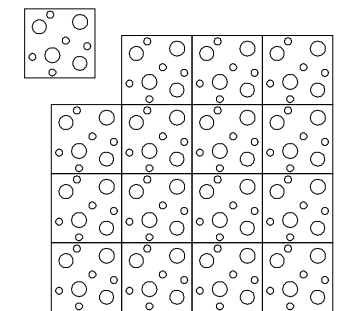

hush.  
*baloon*

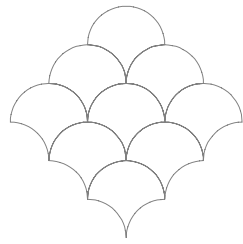

hush.  
*encore*

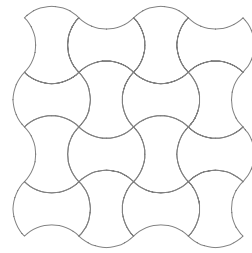

hush.  
*quaver*

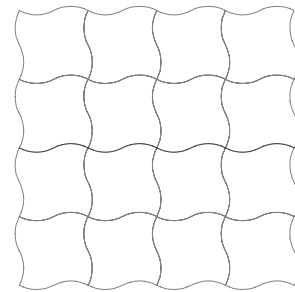

hush.  
*nexus*

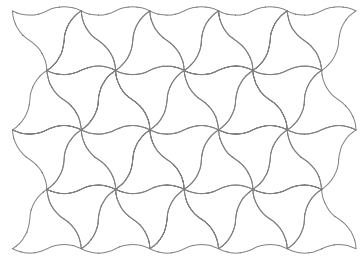

hush.  
*smile*

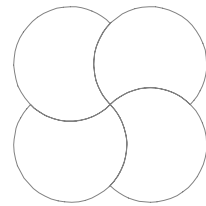

hush.  
*trapezoid*

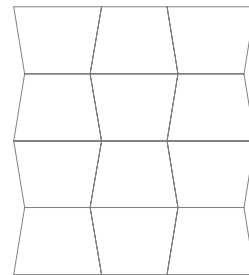

hush.  
*leaf*

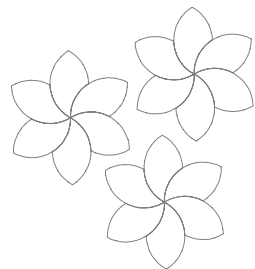

hush.  
*hive*

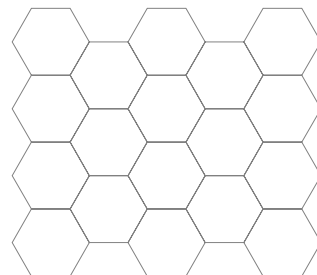

hush.  
*jewel*

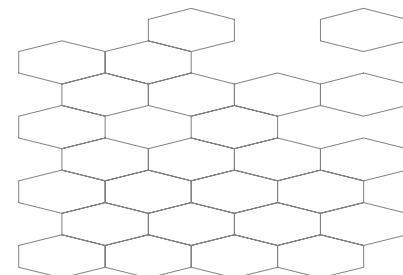

## hush. *encore*

These acoustic wall absorbers offer a great alternative to ceiling elements, particularly in small and medium sized spaces where ceiling absorbers are not effective. The incorporation of hard surface materials are commonly used in the design of these areas contributing to poor acoustical comfort due to very high levels of reverberation. This makes for low speech intelligibility and amplified background noise.

hush.  
*circle*

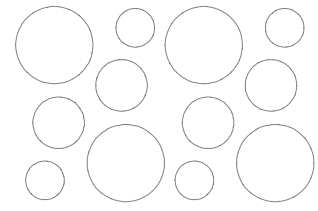

hush.  
*web*

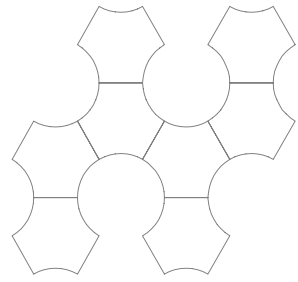

hush.  
*plus*

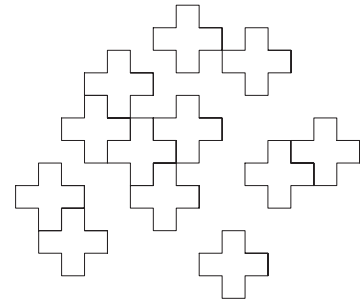

hush.  
*web*



hush.  
*plus*



# hush. *rectangle*

The modern, collaborative office has created a clean look and feel of the modern minimalist environment promoting a flexible area where employees can work more efficiently and effectively - a departure from the inert cubicle settings of the past. The use of hard reflective surfaces has challenged the acoustic qualities of the working environment.

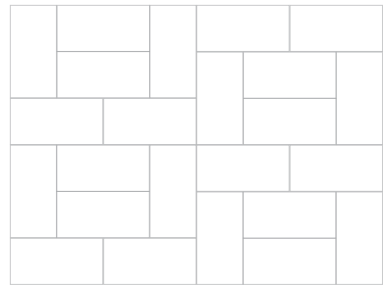



# hush. clouds

The Hush Cloud tiles offers an extensive standard range of acoustic sails in several shapes and designs. Divider panels work well in eating areas providing a degree of privacy as well as improving acoustical properties. Suspended baffles add to the ambiance of a bar or eating area, while wall panels and acoustic murals provided opportunities for public spaces.

circle | square | hexagon | triangle

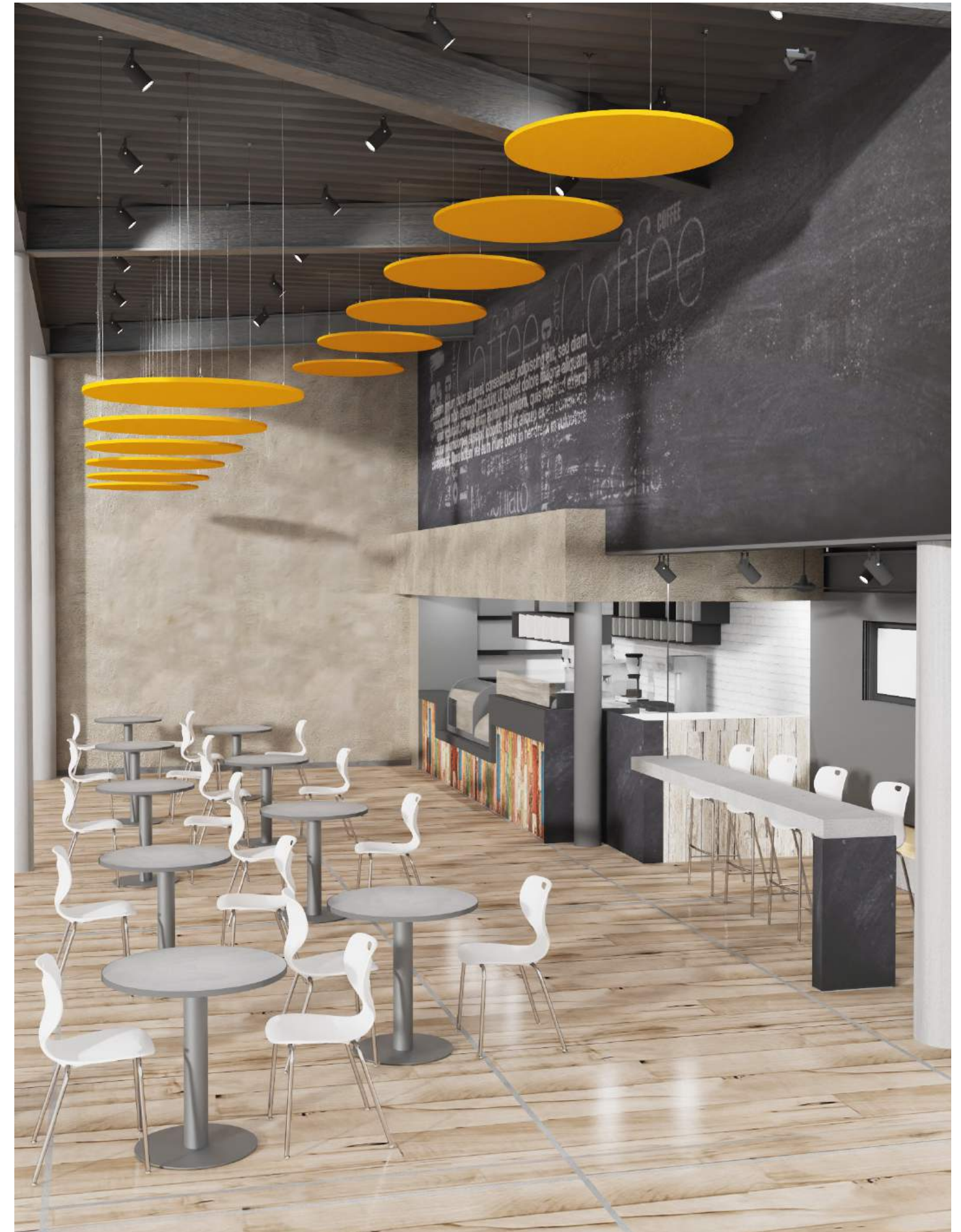

# hush. baffles

Ceiling mounted circular baffles with elliptical profile





hush.  
*linear*

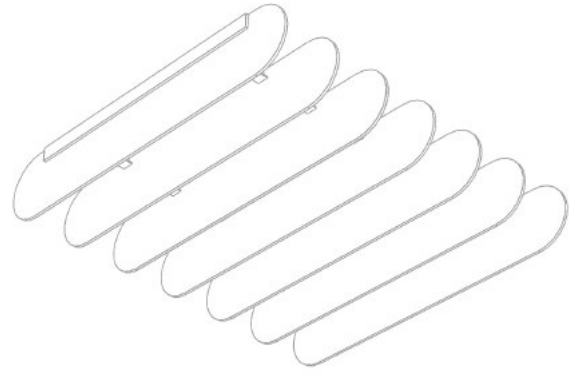

rectangle - rounded profile

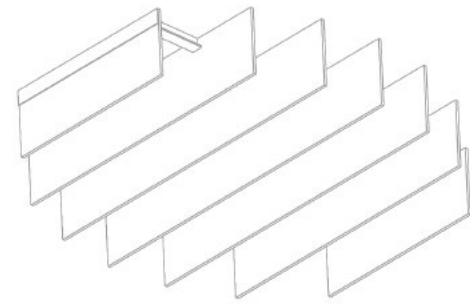

circular - straight profile

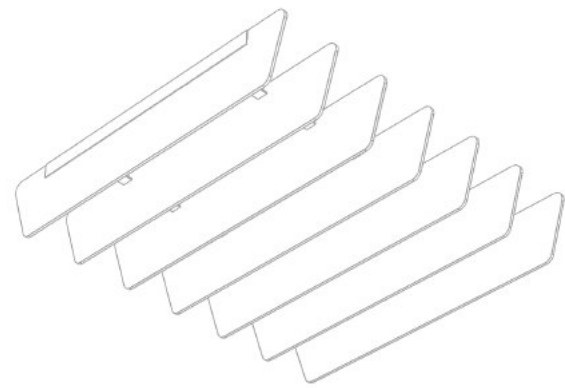

rectangle - angled profile

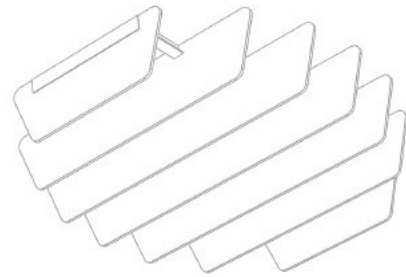

circular - angled profile

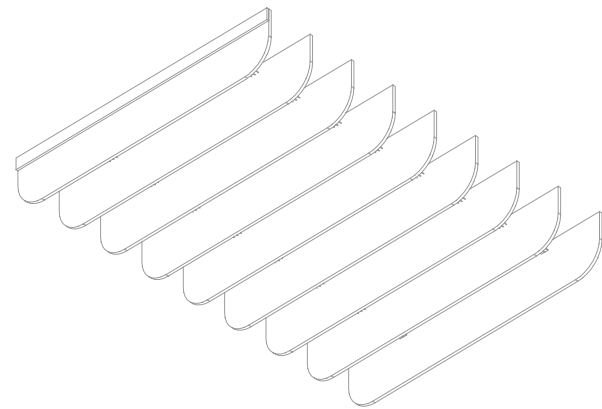

rectangle - quadrant profile

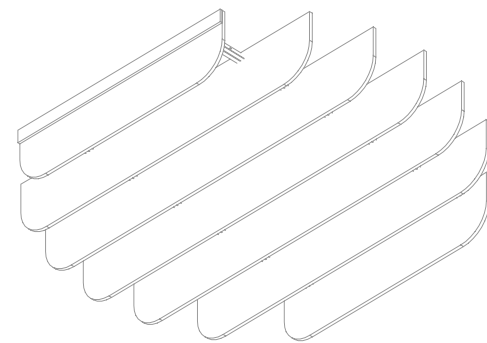

circle - quadrant profile

hush.  
*matrix*

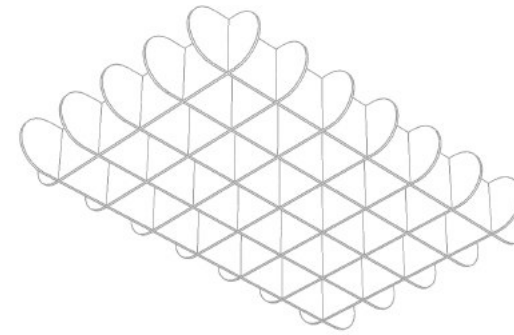

rectangle - rounded profile

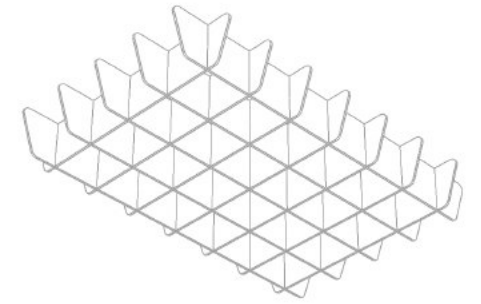

rectangle - angled profile

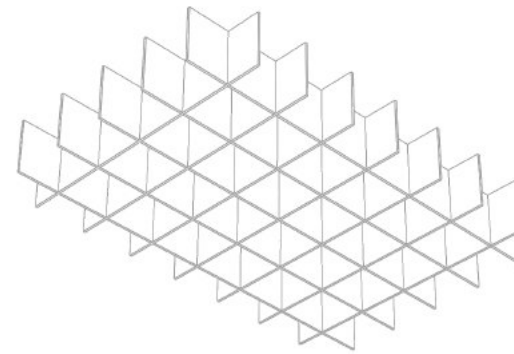

rectangle - straight profile

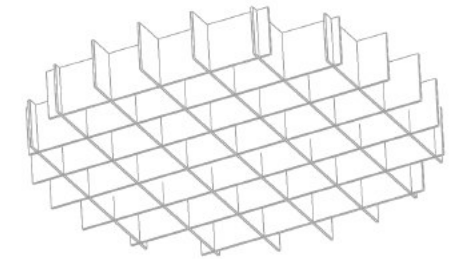

circular - straight profile

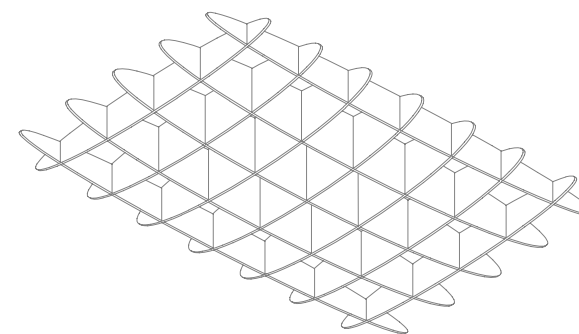

rectangular waffle - elliptical profile

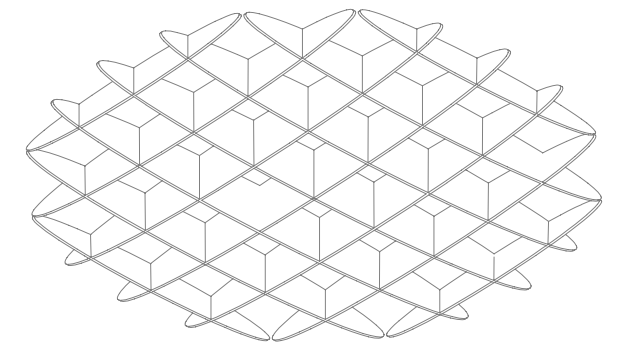

circular waffle - elliptical profile

# hush. *kite*

MityBilt design engineers can work with architects, interior designers and facility planners to achieve the best acoustic outcome for your environment.

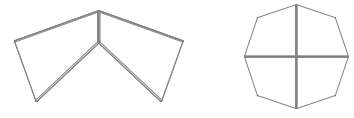



# hush. botanical

Modern interior design continues to focus on creative interior spaces to enhance the client experience and promote branding. The incorporation of hard surface materials are commonly used in the design of these areas contributing to poor acoustical comfort due to very high levels of reverberation. This makes for low speech intelligibility and amplified background noise.

hush.  
*fern*

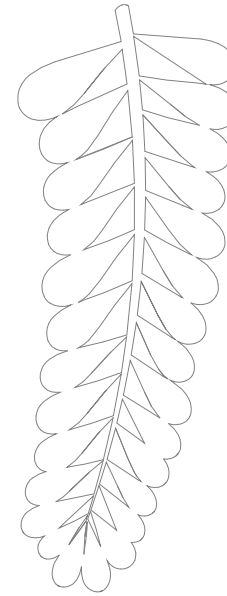

hush.  
*philo*

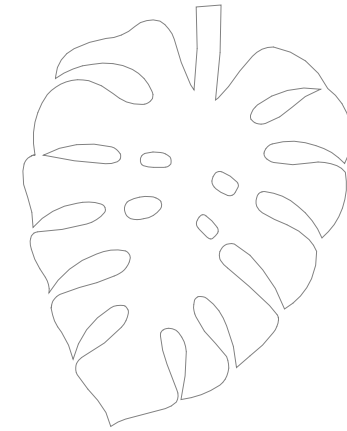

hush.  
*banana*

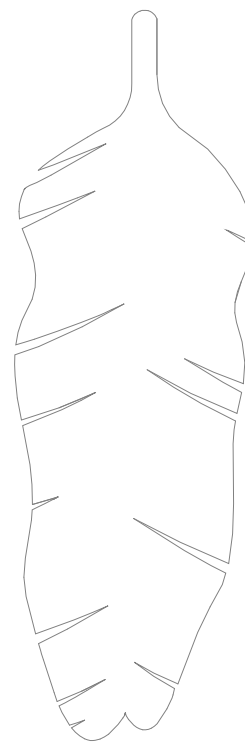

hush.  
*tree*

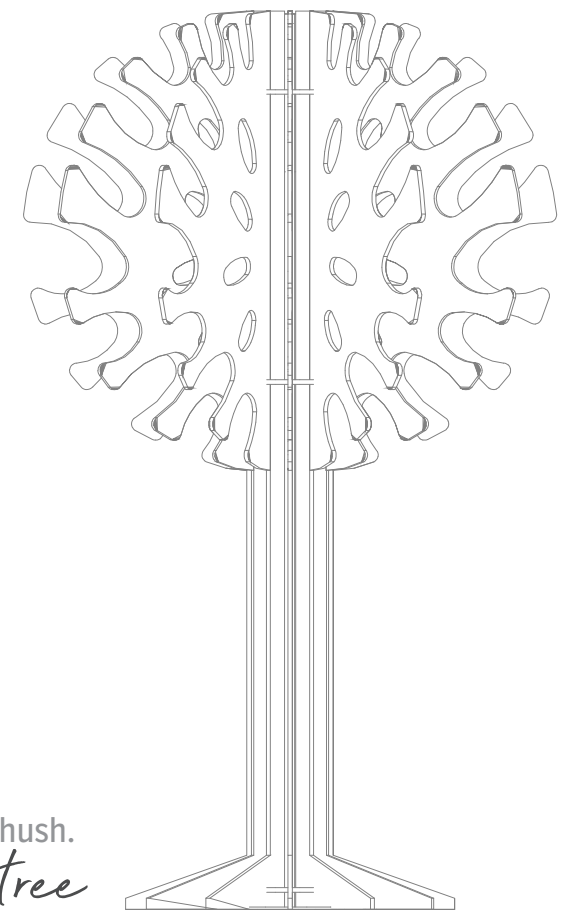



hush.  
room dividers

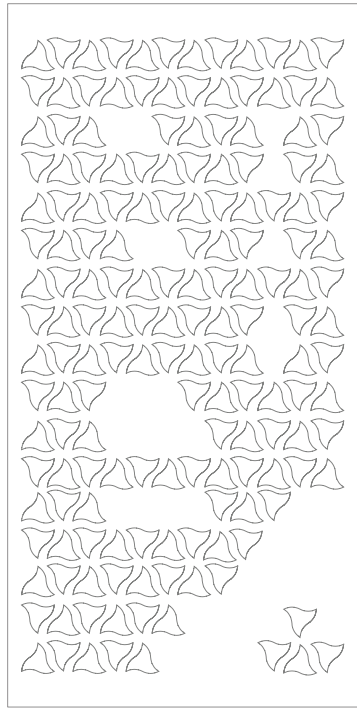

hush.  
*nexus*

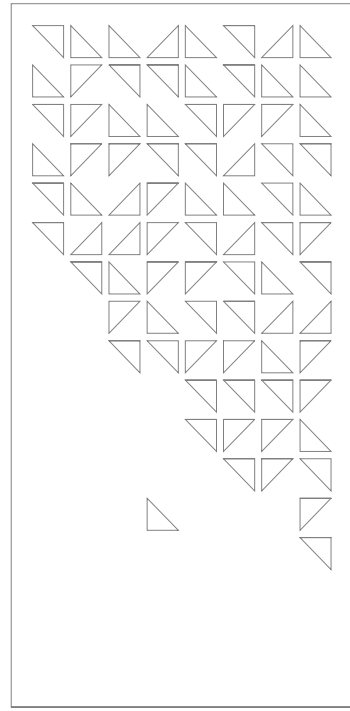

hush.  
*hypotenuse*

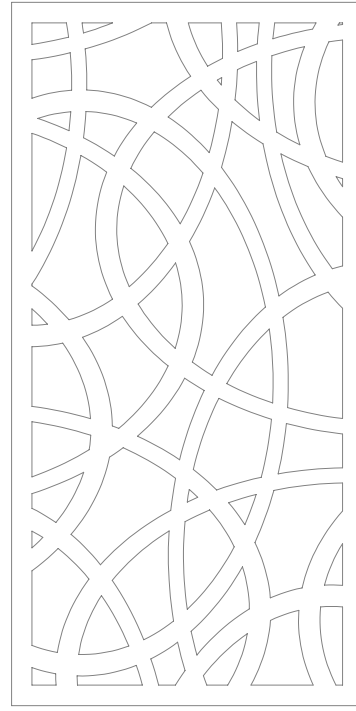

hush.  
*knot*

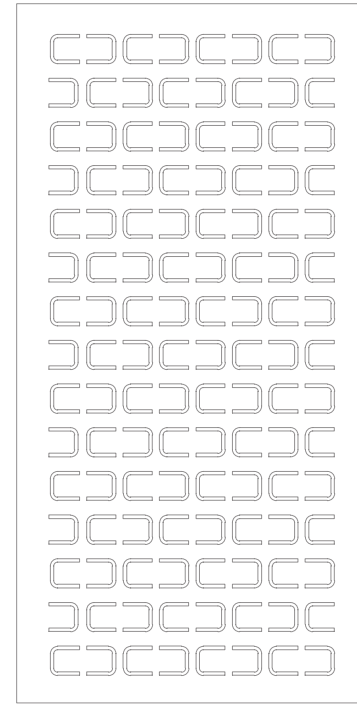

hush.  
*brick*

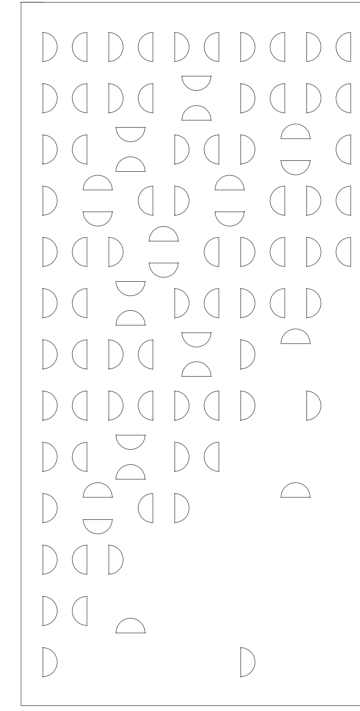

hush.  
*crescent*

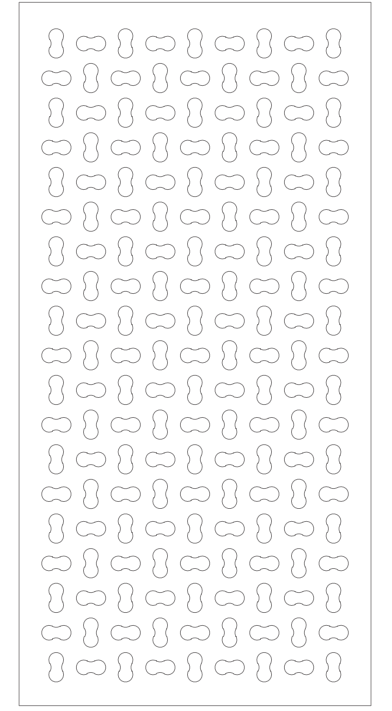

hush.  
*bean*

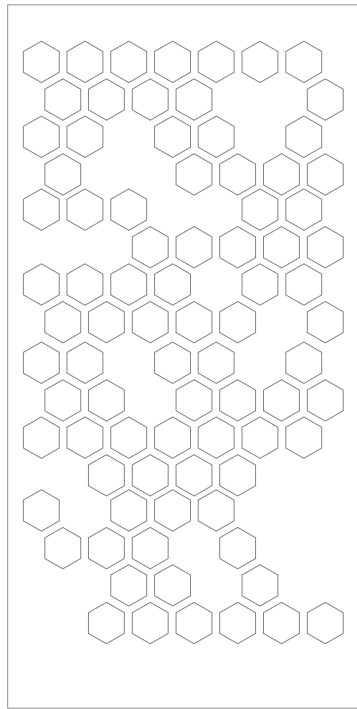

hush.  
*hive*

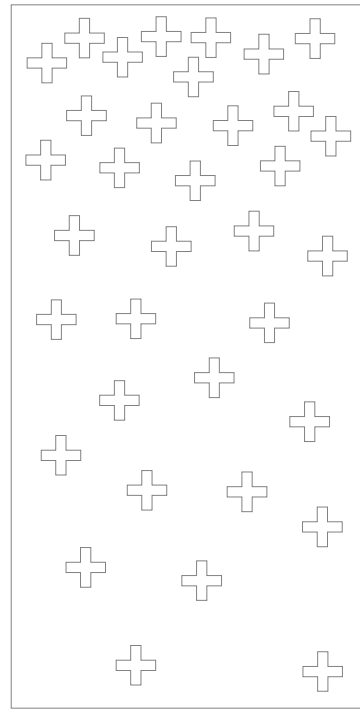

hush.  
*math*

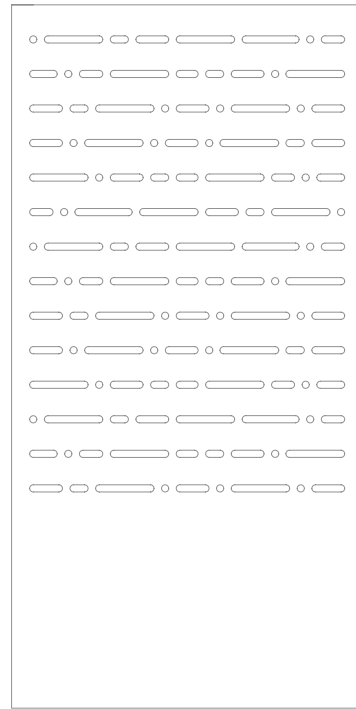

hush.  
*morse code*

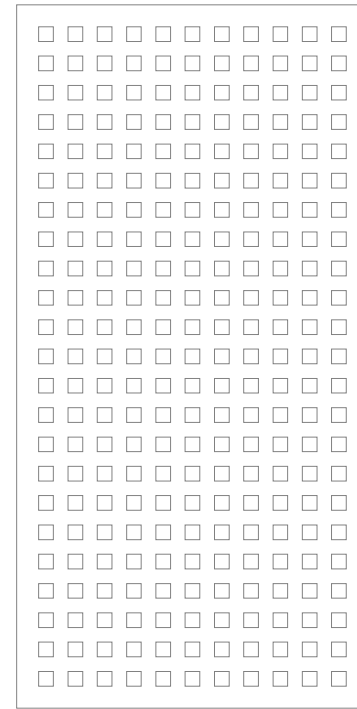

hush.  
*square*

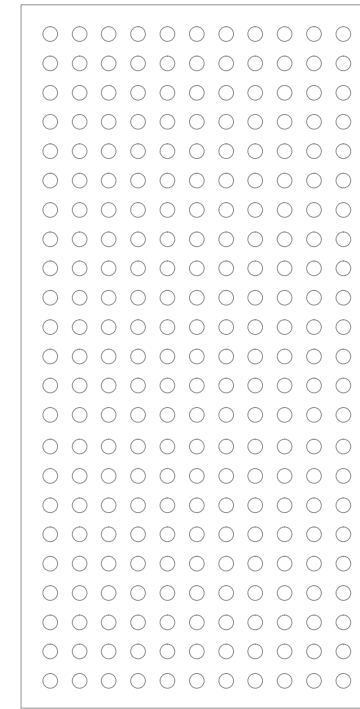

hush.  
*circle*

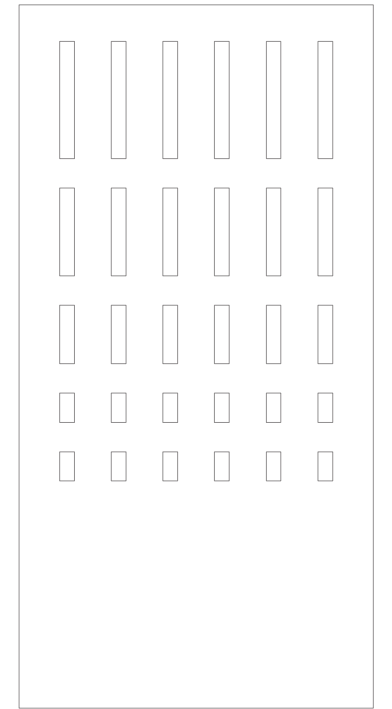

hush.  
*bar*



hush.  
desk dividers



hush.  
*math*

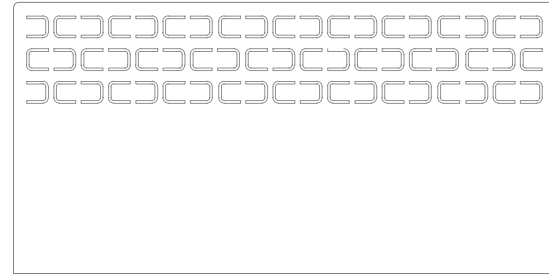

hush.  
*brick*



hush.  
*crescent*



hush.  
*bean*

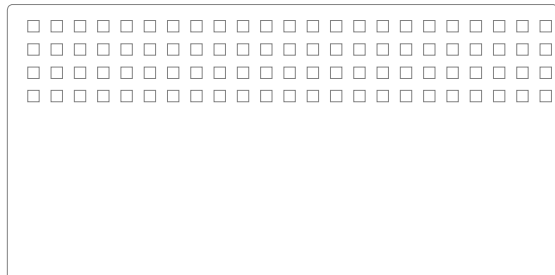

hush.  
*square*

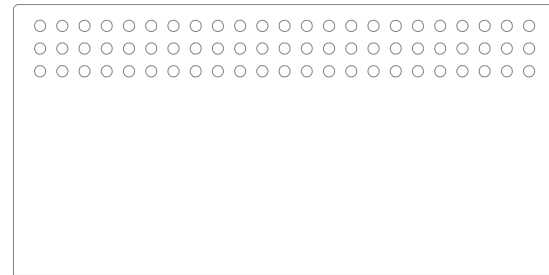

hush.  
*circle*

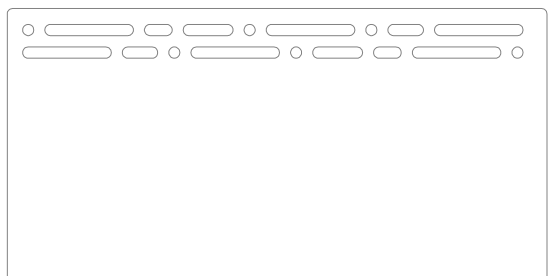

hush.  
*morse code*

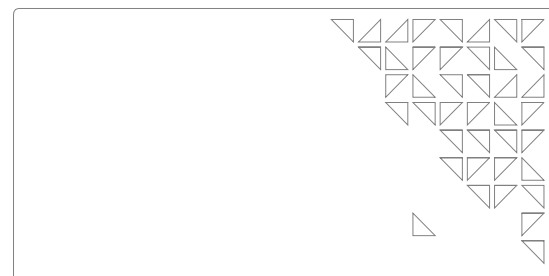

hush.  
*hypotenuse*



hush.  
*math*

Hush Modesty  
Available in complementary designs & in various sizes and thickness.

# hush. murual

Custom printed acoustic murual



The people who are crazy enough  
to think they can change the  
world are the ones who do







### Hush Linear Baffles, Murals & Desk Dividers

Products suited to office environment range from mural images, suspended acoustical baffles and acoustical desk screens.

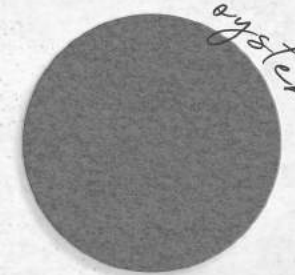
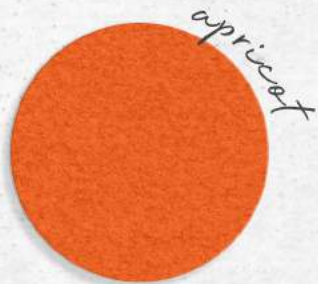

hush.  
colors



# hush. specification

wall tiles

## square

150mm	SWT/1515/9
300mm	SWT/3030/9
600mm	SWT/6060/9
900mm	SWT/9090/9
1200mm	SWT/120120/9

## circle

150mm	CWT/15/9
300mm	CWT/30/9
600mm	CWT/60/9
1200mm	CWT/120/9

## rectangle

150mm x 300mm	RWT/1530/9
150mm x 450mm	RWT/1545/9
150mm x 600mm	RWT/1560/9
150mm x 750mm	RWT/1575/9
150mm x 900mm	RWT/1590/9
300mm x 600mm	RWT/3060/9
300mm x 900mm	RWT/3090/9
300mm x 1200mm	RWT/30120/9
450mm x 600mm	RWT/4560/9
450mm x 900mm	RWT/4590/9
450mm x 1200mm	RWT/45120/9

## triangle

150mm	TWT/1515/9
300mm	TWT/3030/9
600mm	TWT/6060/9

## trapezoid

150mm x 750mm	ZWT/1575/9
150mm x 900mm	ZWT/1590/9
300mm x 900mm	ZWT/3090/9
300mm x 1200mm	ZWT/30120/9

## diamond

520mm x 300mm	DWT/5230/9
---------------	------------

## hive

520mm x 600mm	HWT/5260/9
---------------	------------

## leaf

300mm x 600mm	LWT/3060/9
---------------	------------

## jewel

300mm x 600mm	JWT/3060/9
---------------	------------

## web

600mm	WWT/6060/9
-------	------------

## baloon

600mm	BWT/6060/9
-------	------------

## smile

600mm	SWT/6060/9
-------	------------

## quaver

600mm	QWT/6060/9
-------	------------

## nexus

600mm	NWT/6060/9
-------	------------

## encore

600mm	EWT/6060/9
-------	------------

## plus

600mm	PWT/6060/9
-------	------------

## etch

300mm	ETCH/3030/9
600mm	ETCH/6060/9

matrix baffle

## square

1200mm x 1200mm x 240mm	SMB/120120
1800mm x 1800mm x 240mm	SMB/180180
2400mm x 2400mm x 240mm	SMB/240240

## circle

1200mm Dia. x 240mm	CMB/120R
1800mm Dia. x 240mm	CMB/180R
2400mm Dia. x 240mm	CMB/240R

## rectangle

1200mm x 1800mm x 240mm	RMB/120180
1200mm x 2400mm x 240mm	RMB/120240

## rectangle

1200mm x 1200mm x 240mm	RWB/120120
1200mm x 1800mm x 240mm	RWB/120180
1200mm x 2400mm x 240mm	RWB/120240

## circle

1200mm Dia. x 240mm	CWB/120R
1800mm Dia. x 240mm	CWB/180R
2400mm Dia. x 240mm	CWB/240R

## rectangle - 1500mm length

1800mm x 200mm	RLB15/18020
1800mm x 300mm	RLB15/18030
1800mm x 400mm	RLB15/18040

2400mm x 200mm	RLB15/24020
2400mm x 300mm	RLB15/24030
2400mm x 400mm	RLB15/24040

## rectangle - 3000mm length

1800mm x 200mm	RLB30/18020
1800mm x 300mm	RLB30/18030
1800mm x 400mm	RLB30/18040

2400mm x 200mm	RLB30/24020
2400mm x 300mm	RLB30/24030
2400mm x 400mm	RLB30/24040

linear baffle

## circle

1200mm Dia. x 200mm	CLB/12020R
1500mm Dia. x 200mm	CLB/15020R
1800mm Dia. x 200mm	CLB/18020R
2100mm Dia. x 200mm	CLB/21020R
2400mm Dia. x 200mm	CLB/24020R
1200mm Dia. x 300mm	CLB/12030R
1500mm Dia. x 300mm	CLB/15030R
1800mm Dia. x 300mm	CLB/18030R
2100mm Dia. x 300mm	CLB/21030R
2400mm Dia. x 300mm	CLB/24030R
1200mm Dia. x 400mm	CLB/12040R
1500mm Dia. x 400mm	CLB/15040R
1800mm Dia. x 400mm	CLB/18040R
2100mm Dia. x 400mm	CLB/21040R
2400mm Dia. x 400mm	CLB/24040R

clouds

## circle

600mm Circle Cloud	AC/60R/12
900mm Circle Cloud	AC/90R/12
1100mm Circle Cloud	AC/110R/12

## hexagon

600mm Hexagon Cloud	AC/60H/12
900mm Hexagon Cloud	AC/90H/12
1100mm Hexagon Cloud	AC/110H/12

## square

600mm	AC/60S/12
900mm	AC/90S/12
1100mm	AC/110S/12

## triangle

600mm Triangle Cloud	AC/60T/12
900mm Triangle Cloud	AC/90T/12
1100mm Triangle Cloud	AC/110T/12

## rectangle - patterned

1100mm x 2300mm	LRC/110230/12
-----------------	---------------

## kite

900mm Kite	AMK/9090/12
1200mm Kite	AMK/120120/12

botanical

banana

1000 x 300

ACB/10030/9

fern

800 x 300

ACF/8030/9

philo

600 x 450

ACP/6045/9

tree

1200 x 2400

ACT/120240/12

dividers

room divider

2440mm X 1220mm

ADS/240120/9

2440mm X 1220mm

ADS/240120/12

desk divider

1200mm x 400mm

ADD/40120/12

1500mm x 400mm

ADD/40150/12

1800mm x 400mm

ADD/40180/12

1200mm x 600mm

ADD/60120/12

1500mm x 600mm

ADD/60150/12

1800mm x 600mm

ADD/60180/12

modesty panel

1200mm x 300mm

MOD/30120/12

1500mm x 300mm

MOD/30150/12

1800mm x 300mm

MOD/30180/12



Noise Reduction

Noise Reduction Coefficient - NRC 0.85



Fire Retardant

Class 'A' Interior Wall / Ceiling Finish Category

CAN/ULC-S102-10

ASTM E84-2018



Composition

100% Polyester (min 60% (+/-) recycled PET fiber)



Environment

Made with recycled polyester fiber, 50% +/- of which comes from recycled plastic bottles which contributes to LEED MR credit of Recycled content



Zero Formaldehyde Emission

Test Method GB 18580-2001 Section 6.2

NOISE REDUCTION COEFFICIENT

9mm Hush acoustic panel

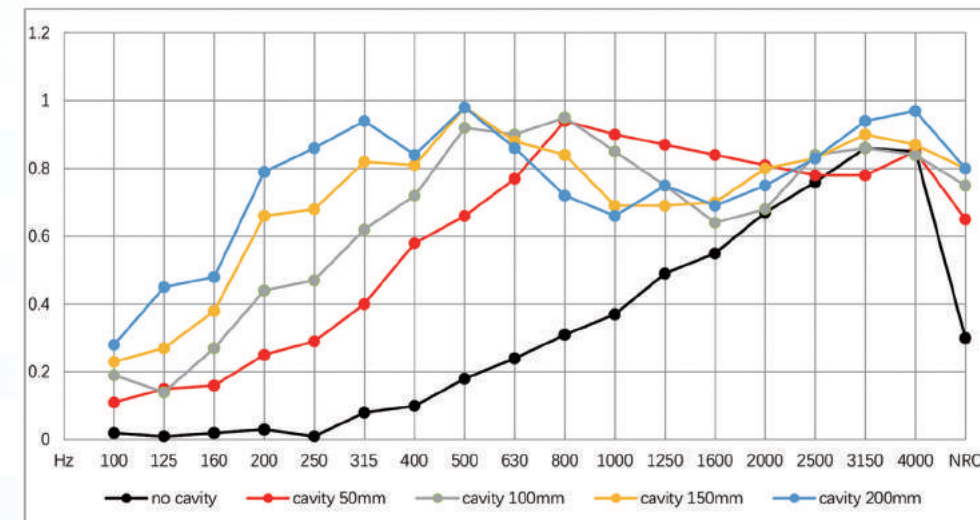

NOISE REDUCTION COEFFICIENT

12mm Hush acoustic panel

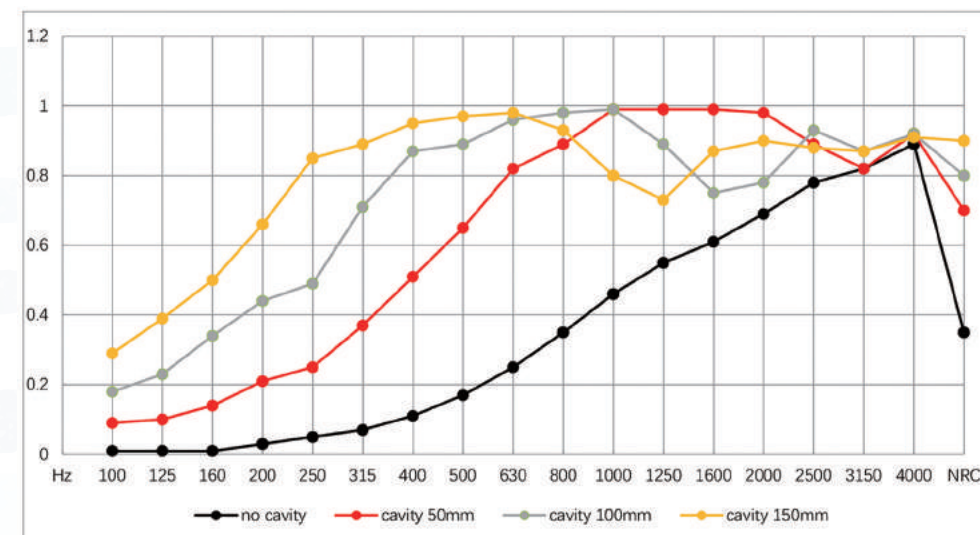



## Made in Canada

MityBilt is Canadian owned and operated. With the wealth and resources available in Canada, all MityBilt products are manufactured using high quality Canadian raw materials.



## Limited Lifetime Warranty

MityBilt is known for best-in-class educational furniture and has built a reputation of engineered products that exceed consumer expectations for quality and durability. For your peace of mind, MityBilt offers a limited lifetime warranty on all products.



## Greenguard Gold Certified

All MityBilt tables and desks conform with the most stringent indoor air quality standards by exceeding the obligations of GreenGuard Gold environmental requirements.



## Standard 100 OEKO-TEX®

Hush acoustic material have been tested for a wide range of hazardous substances. Compliance with STANDARD 100 by OEKO-TEX®, one of the world's best-known labels for textiles tested for harmful substances, assures customer confidence and high product safety.